



NAN HUA PRIMARY SCHOOL
SEMESTRAL ASSESSMENT 2 – 2019
PRIMARY 4
MATHEMATICS

INSTRUCTIONS TO CANDIDATES

1. Write your name, register number and class in the space provided.
 2. Do not turn over the page until you are told to do so.
 3. Follow all instructions carefully.
 4. Answer all questions.
 5. Shade your answers in the Optical Answer Sheet (OAS) provided for Questions 1 - 20.
-

Marks Obtained

Section	Maximum Marks	Actual Marks
A	40	
B	40	
C	20	
Total	100	

Name : _____ ()

Class : Pr 4 _____

Date : 30 October 2019

Duration: 1 h 45 min

Parent's Signature : _____

Section A: Multiple Choice Questions

Questions 1 to 20 carry 2 marks each.

For each question, four options are given. One of them is the correct answer.

Make your choice (1, 2, 3 or 4) and shade your answer on the Optical Answer Sheet.
(40 marks)

1. What is the remainder when 3062 is divided by 4?

- (1) 1
- (2) 2
- (3) 3
- (4) 4

2. In which of the following are the numbers arranged from the smallest to the greatest?

- | | (smallest) | | (greatest) |
|-----|------------|---|-------------|
| (1) | 8230 | , | 8203 , 8023 |
| (2) | 8023 | , | 8230 , 8203 |
| (3) | 8230 | , | 8023 , 8203 |
| (4) | 8023 | , | 8203 , 8230 |

3. Which of the following is a multiple of both 4 and 6?

- (1) 10
- (2) 16
- (3) 30
- (4) 36

4. Two factors of 56 are 2 and 14. What are the other two factors of 56?

- (1) 1 and 4
- (2) 3 and 8
- (3) 4 and 9
- (4) 6 and 7

5. Find the value of $\frac{5}{12} - \frac{1}{4}$

(1) $\frac{1}{2}$

(2) $\frac{1}{3}$

(3) $\frac{1}{6}$

(4) $\frac{1}{12}$

6. Write $4\frac{3}{20}$ as a decimal.

(1) 4.32

(2) 4.3

(3) 4.15

(4) 4.015

7. What is the number when 381.51 is rounded to 1 decimal place?

(1) 381.0

(2) 381.5

(3) 381.6

(4) 382.0

8. The figure shown is made up of a square Y of side 3 cm and a rectangle X with breadth 5 cm. What is length of the rectangle?

(1) 8 cm

(2) 10 cm

(3) 13 cm

(4) 15 cm

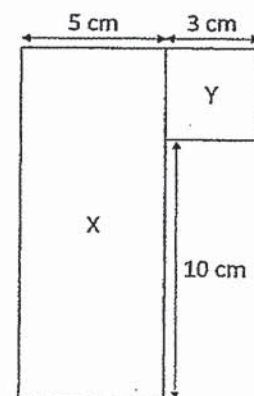

9. The table below shows the wait time for 4 rides in Resort World Sentosa.

Rides	Wait Time
Transformers	25 min
Battlestar Galactica	35 min
Enchanted Airways	1h 25 min
Revenge of the Mummy	1h 35 min

Georgina started queuing for one of the rides at 19 45 and entered at 20 10.
Which ride did she take?

- (1) Transformers
 - (2) Battlestar Galactica
 - (3) Enchanted Airways
 - (4) Revenge of the Mummy
10. The opening hours of a restaurant are shown below. How long is the restaurant open on a Sunday?

Days	Daily Opening Hours
Mon – Fri	10 a.m. to 8.30 p.m.
Sat – Sun	9.45 a.m. to 10.30 p.m.

- (1) 10 h 30 min
- (2) 11 h 30 min
- (3) 12 h 15 min
- (4) 12 h 45 min

11. Benny has 4789 stickers. His sister has 747 stickers less than him. How many stickers do they have altogether?
- (1) 4042
 - (2) 5536
 - (3) 8831
 - (4) 9578
12. Melissa bought 9 m of ribbon to tie 3 similar presents. She used 2.59 m of the ribbon to tie each present. What was the length of the ribbon left?
- (1) 0.41 m
 - (2) 1.23 m
 - (3) 6.41 m
 - (4) 7.77 m
13. Jonathan and Rashid had \$2014 altogether. After Jonathan spent \$274, he had twice as much money as Rashid. How much money did Rashid have?
- (1) \$580
 - (2) \$854
 - (3) \$1434
 - (4) \$1740
14. Mr Tan packed 296 cookies into boxes. Each box contained 7 cookies. He sold each box of cookies at \$4 and the remaining cookies at \$1 each piece. How much would he collect if he sold all cookies?
- (1) \$168
 - (2) \$170
 - (3) \$317
 - (4) \$1184

15. The table below shows the ingredients needed to make 3 pots of tomato soup.

Ingredient	Amount
Tomato	3.9 kg
Onion	1.26 kg
Butter	0.87 kg

David wanted to make 9 pots of tomato soup to sell at his shop.

How much onions would he need to make 9 pots of tomato soup?

- (1) 1.26 kg
- (2) 3.78 kg
- (3) 6.03 kg
- (4) 11.34 kg

16. What is the length of the square?

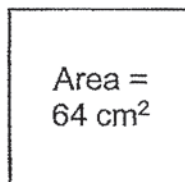

- (1) 8 cm
- (2) 2 cm
- (3) 16 cm
- (4) 32 cm

17. Cai Hong is standing at X and facing one of the points now. After she turns 135° anticlockwise, she will face D. Which point is Cai Hong facing now?

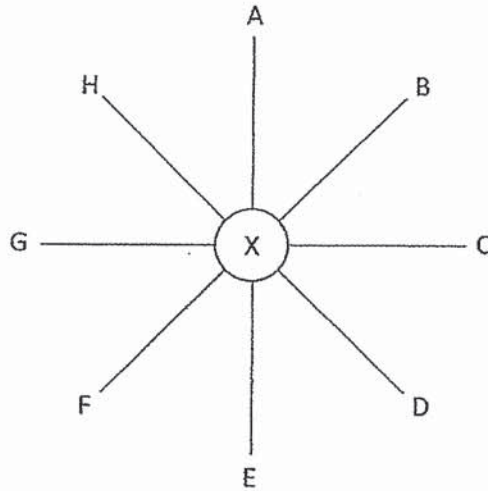

- (1) A
(2) B
(3) F
(4) G
18. Cassandra used $\frac{1}{5}$ kg of flour to make cookies and $\frac{1}{2}$ kg of flour to make brownies. After that, she had $\frac{1}{5}$ kg of flour left. How many kilograms of flour did she have at first?
- (1) $\frac{1}{2}$ kg
(2) $\frac{7}{10}$ kg
(3) $\frac{9}{10}$ kg
(4) 1 kg

The weekly allowance for 5 students is recorded in the bar graph below. Study the graph carefully and answer questions 19 and 20.

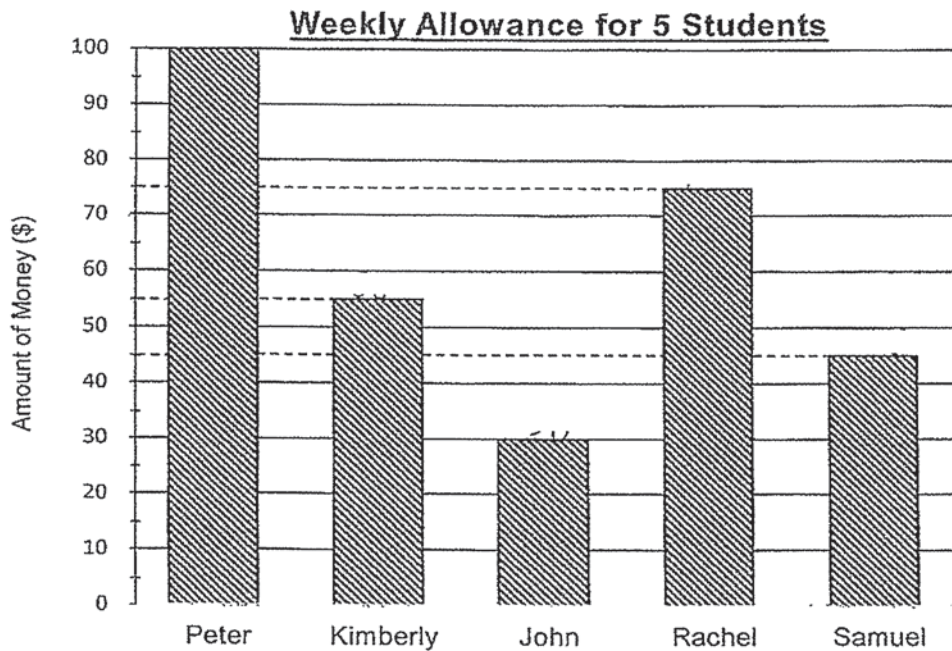

19. Which 2 students had the lowest combined weekly allowance?

- (1) Peter and John
- (2) John and Rachel
- (3) Rachel and Samuel
- (4) Kimberly and Samuel

20. There are 4 weeks in a month.

What is the total allowance of Kimberly and Rachel in a month if they receive the same amount of money every week?

- (1) \$130
- (2) \$305
- (3) \$520
- (4) \$1220

Section B: Open-ended Questions

Questions 21 to 40 carry 2 marks each. Show your working clearly and write your answers in the spaces provided. For questions which require units, give your answers in the units stated. (40 marks)

21. Round 62 930 to the nearest hundred.

Ans:

22. Find the product of 7649 and 7.

Ans:

23. Write the missing number in the number pattern below.

7849 , 7999 , 8149 , _____ , 8449

Ans:

24. Which two fractions below are equivalent to $\frac{6}{12}$?

$\frac{1}{2}$, $\frac{2}{8}$, $\frac{2}{6}$, $\frac{2}{4}$

Ans:

and

25. Arrange the following fractions from the greatest to the smallest.

$$\frac{1}{3}, \frac{5}{6}, \frac{7}{12}$$

_____ , _____ , _____
(greatest) , (smallest)

26. Which two fractions below are smaller than $\frac{1}{2}$?

$$\frac{2}{3}, \frac{3}{7}, \frac{4}{8}, \frac{5}{12}$$

Ans: and

27. Express 0.6 as a fraction.

Ans:

28. Find the value of 7.94×8 .

Ans:

29. Arrange the following numbers from the smallest to the greatest.

$$\frac{4}{5}, 0.805, 0.085$$

_____ , _____ , _____
(smallest) , _____ , (greatest)

30. A cup and 2 identical spoons cost \$14.60. 1 such cup and 1 such spoon cost \$9.90. What is the price of 1 cup?

Ans: \$

31. The figure below is made up of Square X and Rectangle Y.
The side of the square is thrice the breadth of the rectangle.
Find the perimeter of the figure.

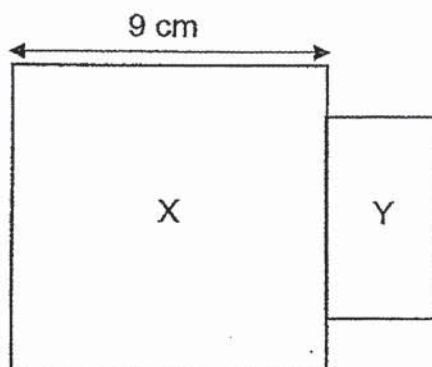

Ans:

cm

32. Complete the symmetric figure with the dotted line as the line of symmetry.

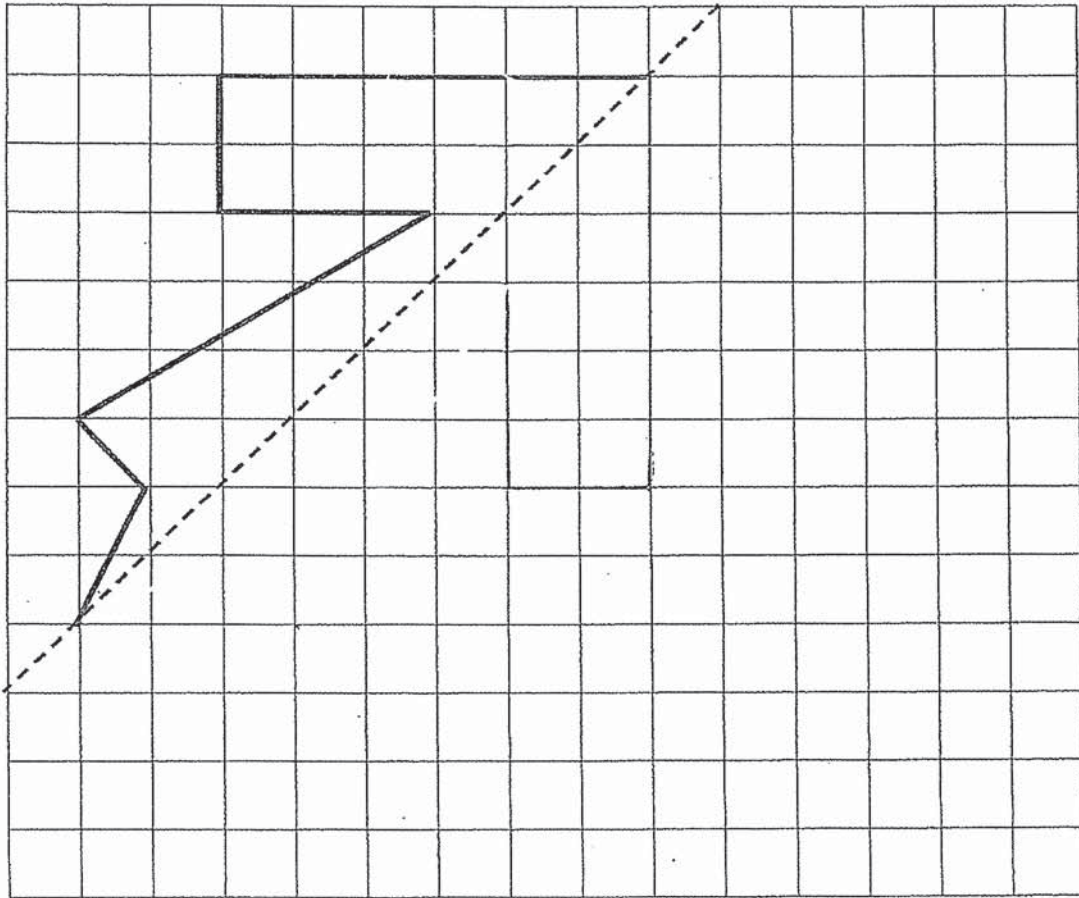

33. In the grid below, draw and label the rectangle ABCD. Lines AB and AC have been drawn for you.

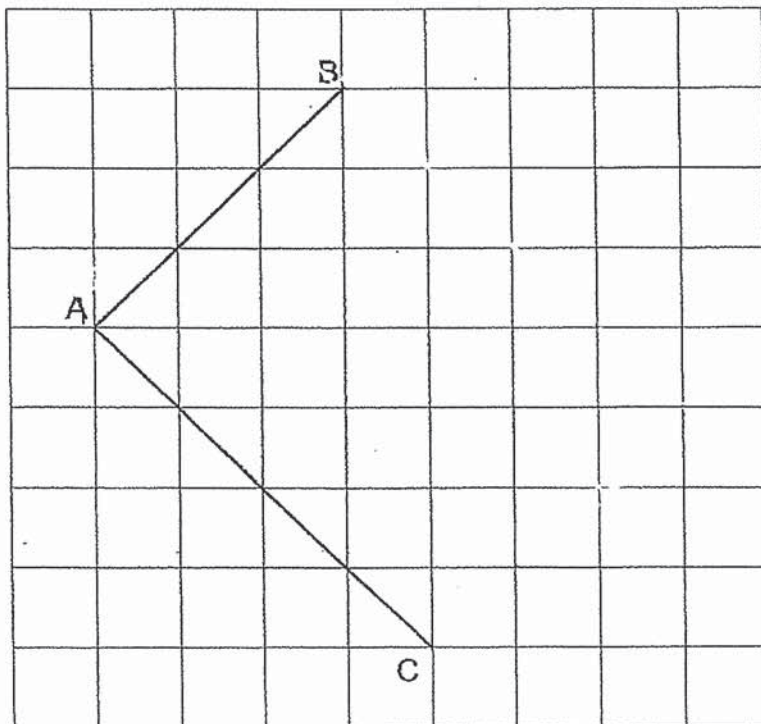

34. Richard drives 7.95 km a day while his brother drives 4.19 km a day.
How much further would Richard have driven in 6 days than his brother?

Ans: km

35. John is 25 years old now and his sister is 18 years younger.
In how many years' time would John be twice as old as his sister?

Ans:

The line graph below shows the volume of water in a tank at a water factory at each 2-hour interval from 0700 to 1900. The tap was turned on to drain the tank at 0900. Study the graph carefully and answer questions 36 to 38.

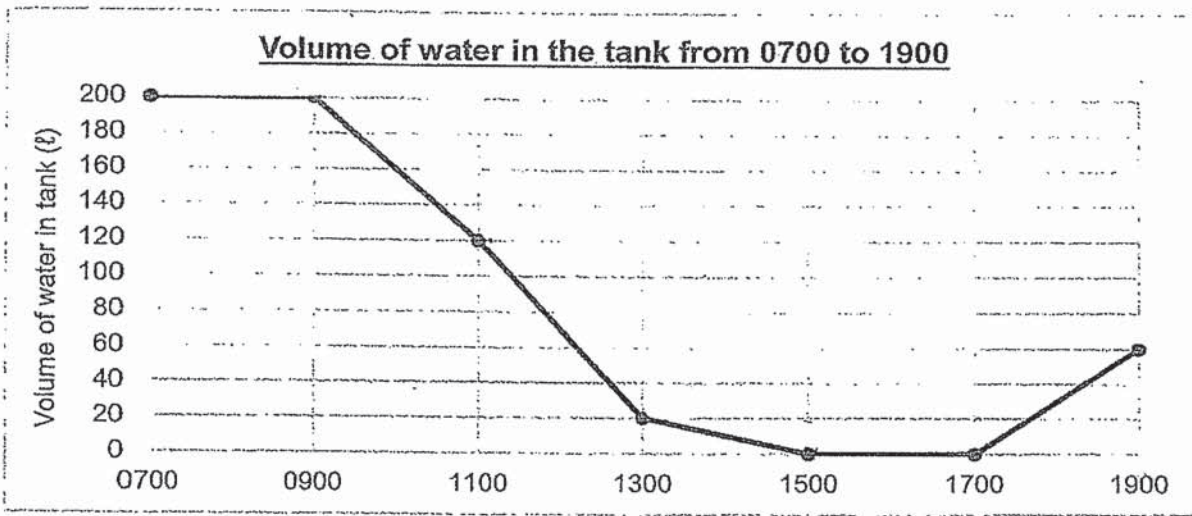

36. During which 2-hour interval was the decrease in volume of water in the tank the greatest?

Ans: to

37. How long did it take to drain the tank completely?

Ans: hours

38. The tank was half-filled at 2100. How much water was added into the tank between 1900 and 2100?

Ans: ℓ

39. Draw $\angle ABC = 137^\circ$ using the given line. Mark and label the angle.



40. Draw a line parallel to MN, passing through point G.

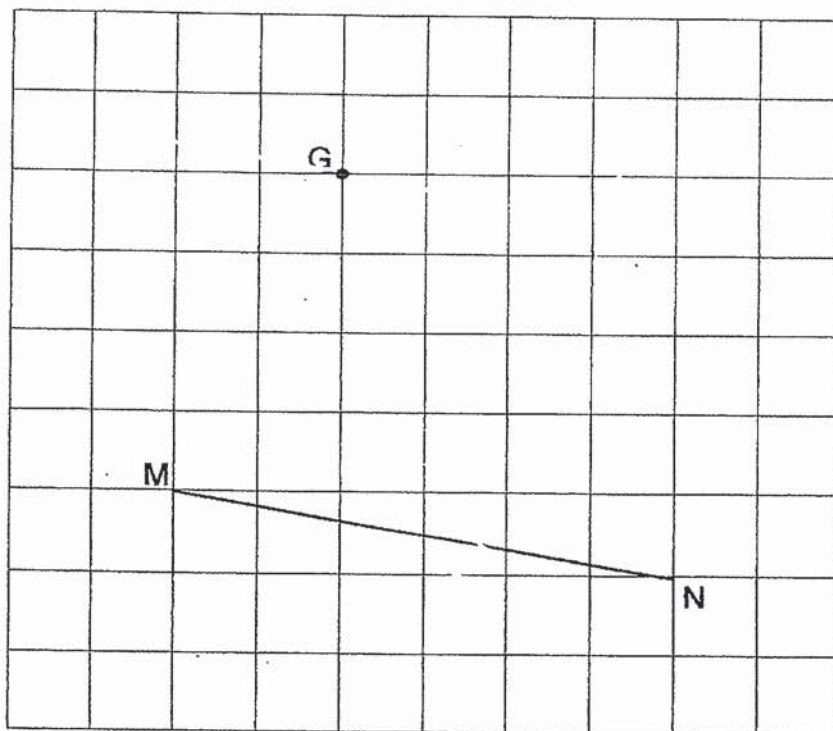

Section C

For each of the following questions, show your working clearly and write your answers in the space provided. The number of marks available is shown in brackets [] at the end of question or part-question. (20 marks)

41. Pole A is $\frac{4}{5}$ m long. It is $\frac{1}{4}$ m longer than Pole B. What is the total length of Pole A and Pole B?
(Express your answer as a mixed number or fraction in its simplest form)

Ans: _____ [3m]

42. Look at the figure below.

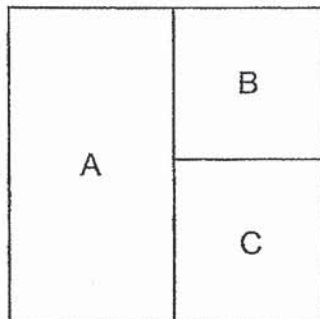

Shapes A, B and C are rectangles and they are not drawn to scale.

Complete the table below by putting a tick (✓) in the box that best describe the shapes given. [3m]

Properties	True	False	Not possible to tell
Shapes A, B and C each have 2 pairs of parallel lines			
Shapes A, B and C each have 4 right angles			
All sides of Shape B are equal			

43. The table below shows the prices of movie tickets in a cinema.

		Type of Cinema	Monday to Thursday	Friday to Sunday
Ticket Prices	Adult	Normal	\$9	\$13.50
		Gold Class	\$29.50	\$42.00
	Children	Normal	\$5	\$5
		Gold Class	\$8.50	\$14.50

Two children went to watch a movie at the Gold Class cinema. How much more would the movie tickets cost if they watched the movie on a Saturday than on a Tuesday?

Ans: _____ [3m]

44. Ahmad, Beatrice and Caili had 2415 cookies at first. After Caili gave away 165 cookies, she had twice as many cookies as Beatrice. Ahmad then gave 290 cookies to Beatrice and Caili had twice as many cookies as him. How many cookies did Beatrice have at first?

Ans: _____ [4m]

45. Woody had some red paint and yellow paint. After buying another 37.84 ℓ of red paint, he had 9 times as much red paint as yellow paint. If he had 10.09 ℓ of yellow paint, how much red paint did he have at first?

Ans: _____ [3m]

46. The figure below is made up of 3 squares, A, B and C. The length of one side of square A is twice the length of one side of square B. The length of one side of square B is twice the length of one side of square C. If the length of square B is 16 cm, find the area of the **shaded** parts of the figure.

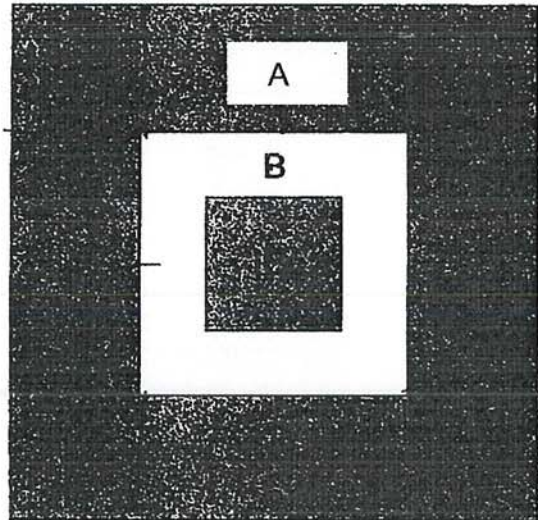

Ans: _____ [4m]

End of paper ☺

ANSWER KEY

YEAR : 2019
LEVEL : PRIMARY 4
SCHOOL : NAN HUA PRIMARY SCHOOL
SUBJECT : MATHEMATICS
TERM : SEMESTRAL ASSESSMENT 2

SECTION A

Q1 2

Q2 4

Q3 4

Q4 1

Q5 3

Q6 3

Q7 2

Q8 3

Q9 1

Q10 4

Q11 3

Q12 2

Q13 1

Q14 2

Q15 2

Q16 1

Q17 4

Q18 3

Q19 4

Q20 3

Q21 62900

Q22 53543

Q23 8299

Q24 $\frac{1}{2}$ OR $\frac{2}{4}$

Q25 $\frac{5}{6}$, $\frac{7}{12}$, $\frac{1}{3}$

Q26 $\frac{3}{7}$ AND $\frac{5}{12}$

Q27 $\frac{6}{10}$

Q28 63.52

Q29 0.085, $\frac{4}{5}$, 0.805

Q30 \$5.20

Q31 42cm

Q32

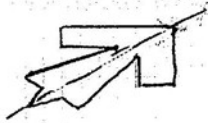

Q33

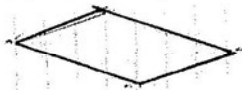

Q34 22.56 km

Q35 11

Q36 11⁰⁰ to 1300

Q37 6 hours

Q38 40¢

Q39 137°

Q40



Q41 $1\frac{7}{20}$ m

Q42

True	False	Not possible to tell
✓		
✓		
		✓

Q43 \$12

Q44 490 cookies

Q45 52.97ℓ

Q46 832cm²

3
END