

CATHOLIC HIGH SCHOOL
MID-YEAR EXAMINATION (2022)
PRIMARY FOUR
MATHEMATICS

Name : _____ ()

Class : Primary 4 _____

Date : 11 May 2022

Total time : 1 h 45 min

45 questions

100 marks

Parent's signature : _____

BOOKLET A	40
BOOKLET B	40
BOOKLET C	20
Total Marks	100

INSTRUCTIONS TO CANDIDATES

Do not turn over this page until you are told to do so.

Follow all instructions carefully.

Answer all questions.

Shade your answers in the Optical Answer Sheet (OAS) provided.

This booklet consists of 23 printed pages and 1 blank page.

Section A

Questions 1 to 20 carry 2 marks each. For each question, four options are given. One of them is the correct answer. Make your choice (1, 2, 3 or 4). Shade the oval (1, 2, 3 or 4) on the Optical Answer Sheet. All diagrams are not drawn to scale. (40 marks)

-
1. The value of the digit 2 in 36 205 is _____.
- (1) 20
(2) 200
(3) 2000
(4) 20 000 ()
-
2. 2 ten thousands + 5 tens + 8 ones = _____.
What is the missing number?
- (1) 2058
(2) 2580
(3) 20 058
(4) 20 508 ()
-
3. In the number 87 326, which digit is in the thousands place?
- (1) 7
(2) 2
(3) 3
(4) 8 ()
-

4. The number line below is marked at equal intervals.
What is the missing number indicated by the arrow on the number line?

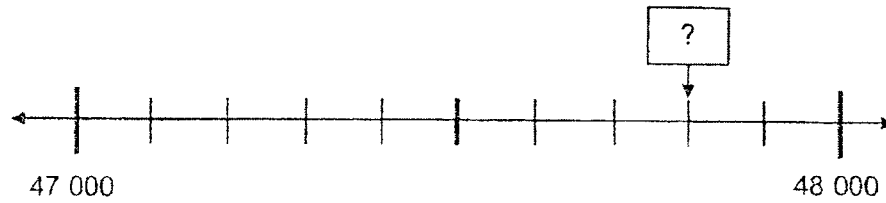

- (1) 47 008
 (2) 47 080
 (3) 47 800
 (4) 48 002 ()

5. Multiply 3804 by 9.

- (1) 27 236
 (2) 29 736
 (3) 34 206
 (4) 34 236 ()

6. Which of the following is a factor of both 28 and 72?

- (1) 6
 (2) 8
 (3) 3
 (4) 4 ()

7. What is the remainder when 6509 is divided by 7?

- (1) 6
- (2) 2
- (3) 929
- (4) 935

()

8. Which of the following is another way to name $\angle a$?

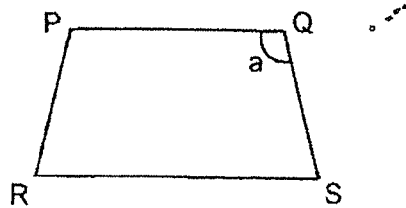

- (1) $\angle RPQ$
- (2) $\angle PQS$
- (3) $\angle QSR$
- (4) $\angle SRP$

()

9. A $\frac{3}{4}$ -turn is _____.

- (1) 45°
- (2) 90°
- (3) 270°
- (4) 360°

()

10. Which of the following is a multiple of 4?

- (1) 14
- (2) 2
- (3) 26
- (4) 36

()

11. In the figure below, ABCD is a square. $\angle EBD$ is 120° . $\angle DBC$ is 45° . Find $\angle EBA$.

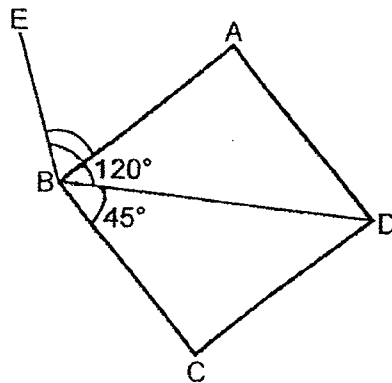

- (1) 45°
- (2) 60°
- (3) 75°
- (4) 85°

()

12. There are 145 rows of students in the parade square. Each row has 23 students. How many students are there altogether?

- (1) 725
- (2) 3335
- (3) 4335
- (4) 4655

()

13. In the square grid below, which of the following dotted lines is the line of symmetry of the figure?

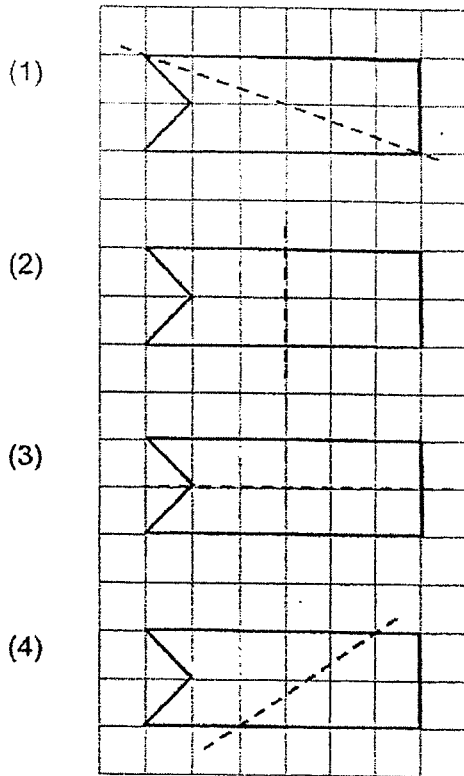

()

14. In the square grid below, which of these following figures are symmetrical?

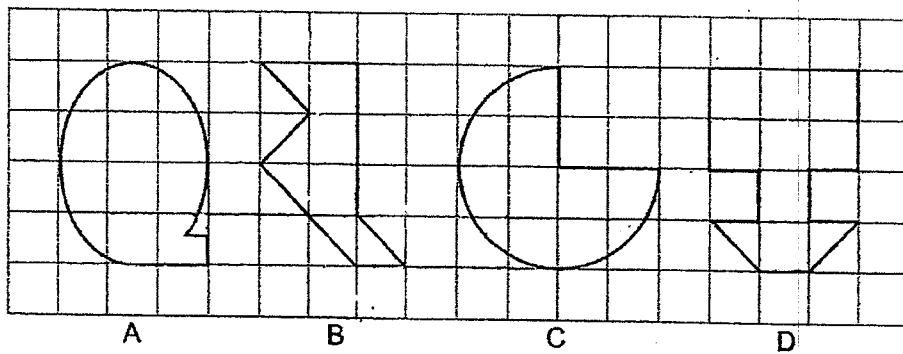

- (1) A and B
- (2) A and C
- (3) B and D
- (4) C and D

()

15. The following square grid shows the position of A, B, C, D and F. Which letter is north-east of A?

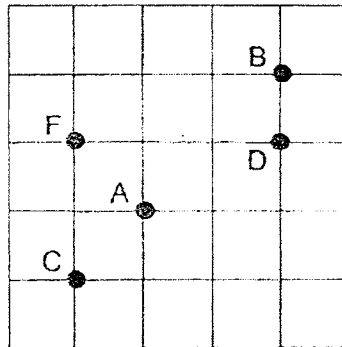

- (1) B
 (2) C
 (3) D
 (4) F ()

16. A factory produced 2470 bags. It produced 595 fewer caps than bags. How many caps did the factory produce?

- (1) 1875
 (2) 1975
 (3) 2965
 (4) 3065 ()

17. Mrs Ong wants to buy 5209 erasers. The erasers are sold in packets of 4. What is the least number of packets of erasers she needs to buy?

- (1) 132
 (2) 133
 (3) 1302
 (4) 1303 ()

18. Peter and James have a total of \$7950. Peter has twice as much money as James. How much money must Peter give to James so that they will have the same amount of money?

- (1) \$1325
(2) \$2650
(3) \$3975
(4) \$5300

()

-
19. For every 5 cupcakes purchased, 1 additional cupcake will be given free. What is the least amount of money Mrs Lee pays for 20 cupcakes?

 \$4 each	<p style="text-align: center;"><u>Promotion</u></p> <p style="text-align: center;">Buy 5 cupcakes and get 1 additional cupcake Free!</p>
--	--

- (1) \$24
(2) \$60
(3) \$68
(4) \$80

()

20. Samantha was at one of the points shown in the grid below. Then she walked 2 steps to the west, 3 steps to the south and 4 steps to the east. She ended at Point K. Which point was she at at first?

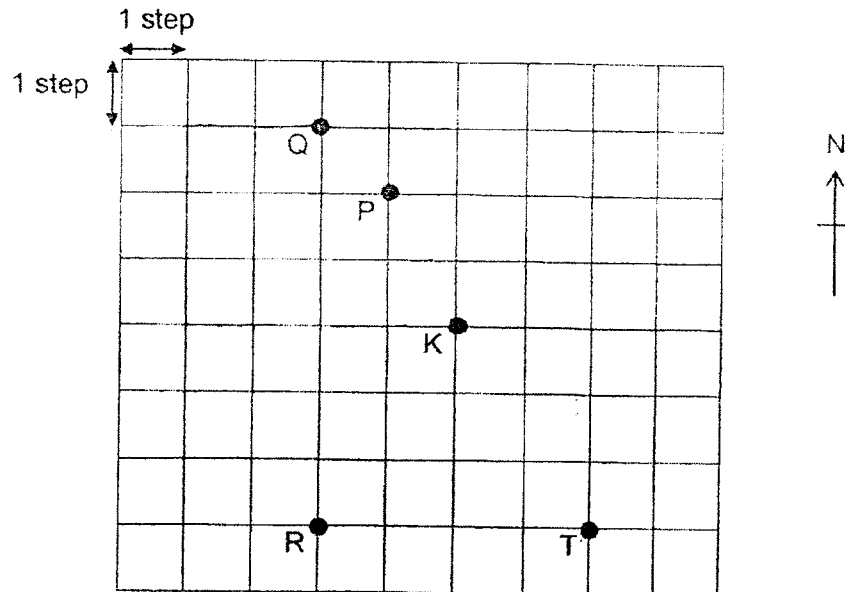

- (1) P
 (2) Q
 (3) R
 (4) T

()

END OF SECTION A

Section B

Questions 21 to 40 carry 2 marks each. Show your working clearly and write your answers in the spaces provided. For questions which require units, give your answers in the units stated. All diagrams are not drawn to scale. (40 marks)

Do not write
in this space

21. Write thirty thousand, two hundred and one in numerals.

Ans: _____

22. What is the smallest 5-digit odd number that can be formed using the digits 8, 3, 5, 4 and 1? Each digit can only be used once.

Ans: _____

23. Write the missing number in the number pattern below.

21 140 , 21 040 , _____ ? _____ , 20 840 , 20 740 , 20 640

Ans: _____

24. Round 25 675 to the nearest hundred.

Do not write
in this space

Ans: _____

25. When a number is divided by 3, it has a quotient of 253 and a remainder of 2. What is the number?

Ans: _____

26. Some of the factors of 32 are 1, 2, 8 and 32.
List down two other factors of 32.

Ans: _____ and _____

27. Arrange the following numbers from the greatest to the smallest.

62 085 , 62 850 , 62 805

Do not write
in this space

Ans: _____ , _____ , _____
(greatest) (smallest)

28. There was a total of 20 motorcycles and cars in a carpark. The vehicles had a total of 50 wheels.

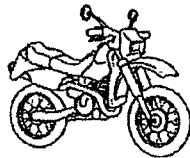

motorcycle



car

The statement below is true, false or not possible to tell from the information given. For the statement, put a tick (✓) in the correct column.

Statement	True	False	Not possible to tell
There was an equal number of motorcycles and cars in the carpark.			

29. The figure below is made up of two rectangles. Find the length of DG.

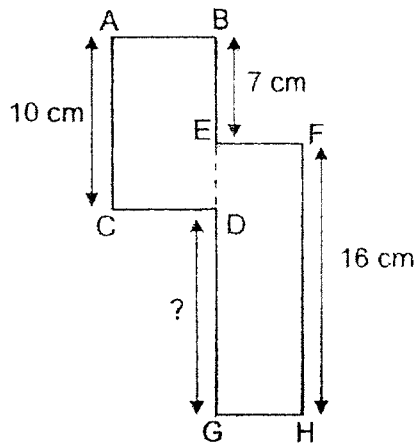

Do not write
in this space

Ans: _____ cm

30. A number is between 10 and 35. It is a common multiple of 3 and 5. One of its factors is 6. What is the number?

Ans: _____

31. Amanda paid a total of \$1620 for 2 air purifiers and 3 fans. Each air purifier cost thrice as much as a fan. How much did each fan cost?

Do not write
in this space

Ans: \$ _____

32. Decorative lights, A and B, turn red at a shopping mall. Decorative light A turns red every 2 minutes and decorative light B turns red every 3 minutes after they are switched on. Both lights are switched on at 8 p.m. and switched off at 8.35 p.m. How many times will both decorative lights A and B turn red at the same time?

Ans: _____

33. The figure below is made of 4 identical squares. Find the length of the figure.

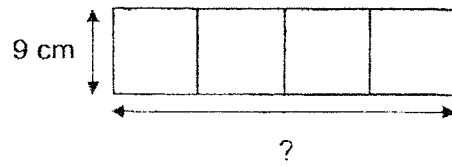

Do not write
in this space

Ans: _____ cm

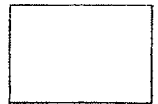

34. Measure and write down the size of $\angle a$.

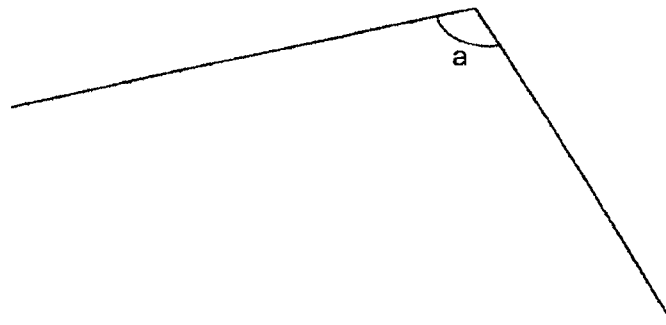

Ans: _____ °



35. In the figure below, PQRS is a rectangle. Find $\angle q$.

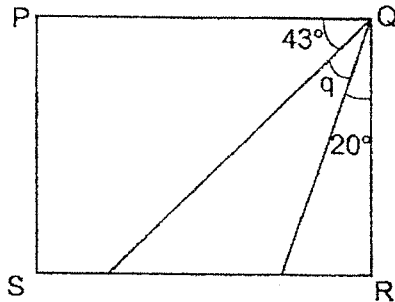

Do not write in this space

Ans: _____°

36. Look at the 8-point compass below. David was standing at point A. When David turned 225° in an anti-clockwise direction, he then faced the hotel. Where was he facing at first?

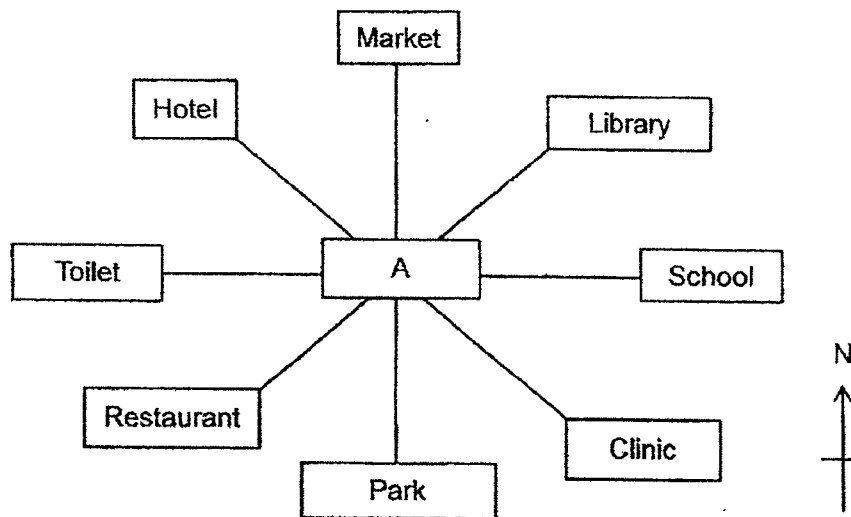

Ans: _____

37. The figure below is a square paper folded at one of its corner. Find $\angle p$.

Do not write in this space

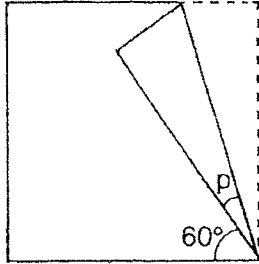

Ans: _____^o



38. In the square grid below, AB is one side of a square. Draw a square with AB as one side of the square.

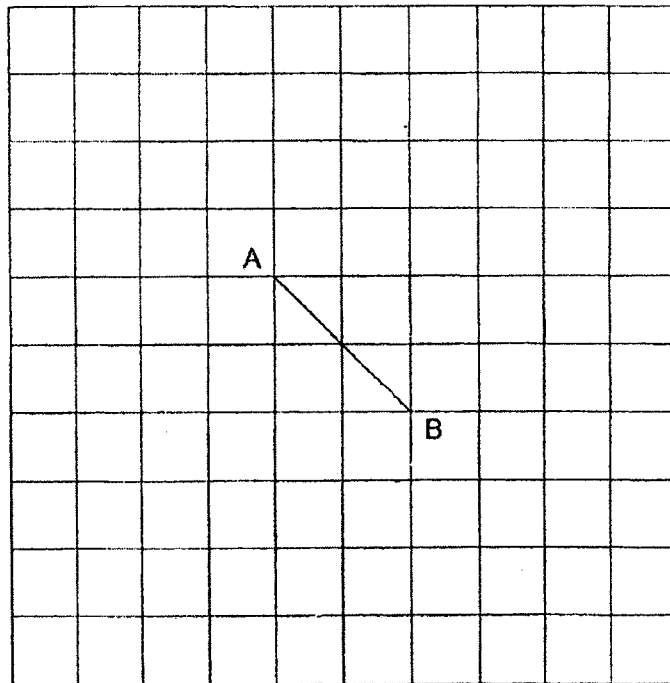

39. There was an equal number of boys and girls in a classroom. After 15 boys left the classroom and 10 girls entered the classroom, there were 20 boys in the classroom in the end. How many children were there in the classroom in the end?

Do not write in this space

Ans: _____

40. In the figure below, line AB is a line of symmetry. Shade 2 unit squares to make the figure symmetrical.

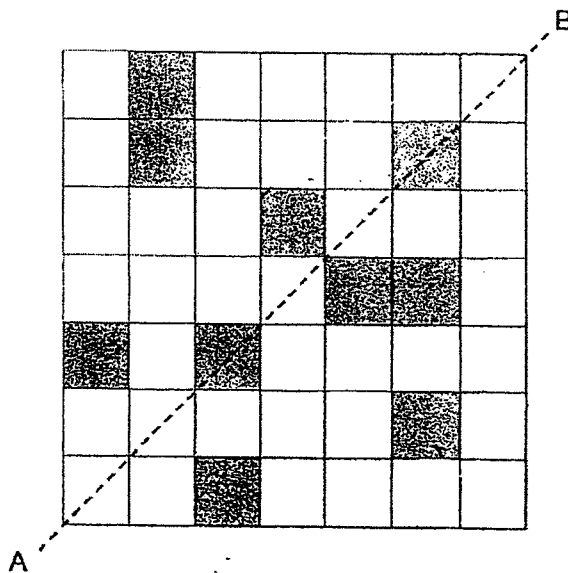

Total marks for questions 21 to 40

END OF SECTION B

40

Section C

For Questions 41 to 45, show your working clearly and write your answers in the spaces provided. The number of marks available is shown in brackets [] at the end of each question or part-question. All diagrams are not drawn to scale.
(20 marks)

Do not write
in this space

41. Janet had 680 more stickers than Kayla. After Kayla used 78 stickers, Janet had thrice as many stickers as Kayla. How many stickers did Kayla have at first?

Ans: _____ [4]

42. Laurence had 3700 marbles. He gave 300 marbles to his brother and received 150 marbles from his sister. He then put the remaining marbles into 5 boxes equally. How many marbles did he put in each box?

Do not write
in this space

Ans: _____ [4]

43. Audrey bought a dining table and 4 similar chairs. The dining table cost \$821 more than the total cost of the 4 chairs. She gave the cashier \$2800 and received \$43 change. How much did each chair cost?

Do not write
in this space

Ans: _____ [4]

44. The total mass of a basket and a durian is 3770 g. When a bunch of grapes is added into the basket, the total mass becomes 4450 g. The durian is 4 times as heavy as the bunch of grapes. Find the mass of the basket. (Give your answer in grams)

Do not write
in this space

Ans: _____ [4]

45. Alice, Betty and Clara have a total of 2400 beads. Betty has 20 more beads than Alice. Clara has twice the total number of beads Alice and Betty have. How many beads does Betty have?

Do not write
in this space

Anş: _____ [4]

END OF PAPER

YEAR : 2022
 LEVEL : PRIMARY 4
 SCHOOL : CATHOLIC HIGH SCHOOL
 SUBJECT : MATH
 TERM : MID YEAR EXAMINATION

(BOOKLET A)

Q1	2	Q2	3	Q3	1	Q4	3	Q5	4
Q6	4	Q7	1	Q8	2	Q9	3	Q10	4
Q11	3	Q12	2	Q13	3	Q14	4	Q15	1
Q16	1	Q17	4	Q18	1	Q19	3	Q20	2

(BOOKLET B)

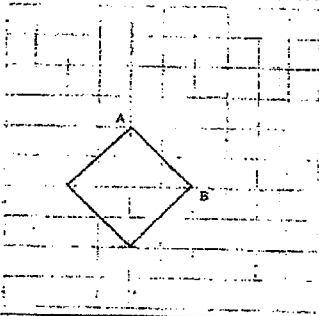
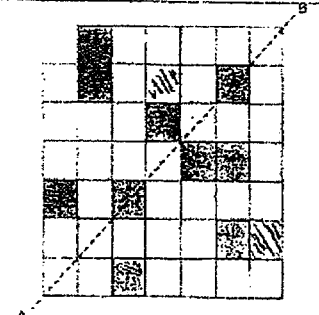
Q21	30 201	Q22	13 485
Q23	20 940	Q24	25 700
Q25	$\underline{\quad} \div 3 = 253R2$ $253 \div 3 = 759$ $759 + 2 = 761$	Q26	$32 \times 1 = 32$ $2 \times ? = 32$ $8 \times ? = 32$ 16 and 4
Q27	62 850, 62 805, 62 085	Q28	False ✓
Q29	13cm	Q30	30
Q31	$9u = 1620$ $u = 1630 \div 9$ $= \$180$	Q32	18:06pm 28:12pm 38:18pm 48:24pm 58:30pm Ans: 5
Q33	$9 \times 4 = 36\text{cm}$	Q34	116°
Q35	$43 + 20 = 63$ $90^\circ - 63 = 27^\circ$	Q36	Park
Q37	$90 - 60 = 30$ $P = 30 \div 2 = 15^\circ$	Q38	
Q39	$20 + 15 + 10 + 20 = 65$	Q40	
Q41	$680 + 78 = 759$	Q42	$300 - 150 = 150$

	$758 = 2u$ $u = 758 \div 2 = 379$ $379 + 78 = 457$ Kayla had 457 stickers at first.		$3400 + 150 = 3550$ $3550 \div 5 = 710$ He put 710 marbles in each box.
Q43	$2800 - 43 = 2757$ $2757 - 821 = 1936$ $1936 \div 8 = 242$ Each chair cost \$242.	Q44	$B + D = 3770$ $B + D + G = 4450$ $G = 4450 - 3770 = 680$ $D = 680 \times 4 = 2720$ $B = 3770 - 2720$ $= 1050g$ The mass of the basket 1050g.
Q45	$6u = 2340$ $u = 2340 \div 6 = 390$ $390 + 20 = 410$ Betty has 410 beads.		