

**Red Swastika School  
Primary 5  
Weighted Assessment 1  
Mathematics**

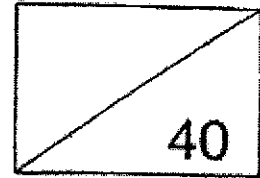

Name: \_\_\_\_\_ ( )

Date: 7 May 2021

Class: \_\_\_\_\_

Duration: 40 minutes  
( Use of calculator is not allowed )

Parent's Signature: \_\_\_\_\_

Questions 1 to 10 carry 2 marks each. For each question, four options are given. One of them is the correct answer. Make your choice (1, 2, 3 or 4) and write its number in the brackets provided. (20 marks)

1 What is the value of the digit 6 in 560 378?

- (1) 60
- (2) 600
- (3) 6000
- (4) 60 000

( )

2 Find the value of  $30 - 4 \times (8 - 2) + 2$ .

- (1) 18
- (2) 48
- (3) 3
- (4) 78

( )

3  $\frac{3}{4} =$  \_\_\_\_\_

- (1) 0.3
- (2) 0.34
- (3) 0.75
- (4) 6.2

( )

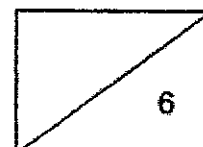

4  $\frac{4}{5} \times 80 = \underline{\hspace{2cm}}$

- (1) 64
- (2) 60
- (3) 16
- (4) 4

( )

- 5 In the diagram below, FG is 6 cm, FE is 10 cm and DG is 8 cm. What is the area of triangle DEF?

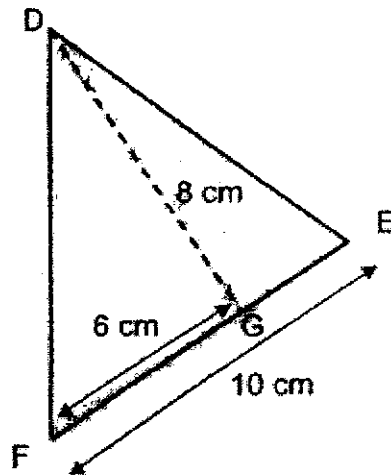

- (1) 24 cm<sup>2</sup>
- (2) 40 cm<sup>2</sup>
- (3) 48 cm<sup>2</sup>
- (4) 80 cm<sup>2</sup>

( )

- 6 24 x 2000 has the same value as 20 x 2000 + 8 x                     .  
What is the missing number?

- (1) 1000
- (2) 2000
- (3) 4000
- (4) 8000

( )

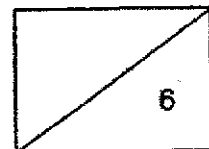

- 7 Tom and Jerry were having a race. The total time they took to complete the race was 64 minutes. Tom was 10 minutes faster than Jerry. Which of the following expressions can be used to find out how much time Jerry took to complete the race?

- (1)  $64 \div 2 - 10$   
 (2)  $64 \div 2 + 10$   
 (3)  $(64 - 10) \div 2$   
 (4)  $(64 - 10) \div 2 + 10$

( )

8  $\frac{3}{8} \times 24 = \square \times 12 + 3$

What is the missing fraction in the box?

- (1)  $\frac{1}{2}$   
 (2)  $\frac{3}{4}$   
 (3)  $\frac{3}{5}$   
 (4)  $\frac{1}{64}$

( )

- 9 M is the midpoint of EF in square DEFG. If the total area of the shaded parts is  $72 \text{ cm}^2$ , what is the perimeter of square DEFG?

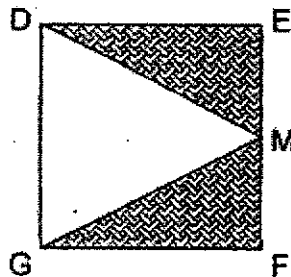

- (1) 36 cm  
 (2) 48 cm  
 (3) 72 cm  
 (4) 144 cm

( )

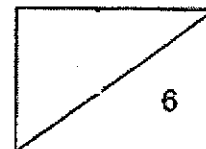

- 10 The figure below is made up of 4 identical rectangles. The area of triangle WYZ is  $64 \text{ cm}^2$ . Find the total area of the unshaded parts of rectangle VWXZ.

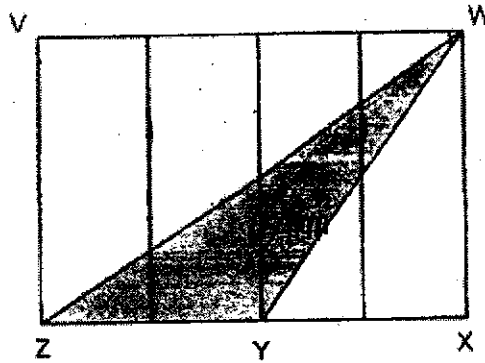

- (1)  $64 \text{ cm}^2$
- (2)  $128 \text{ cm}^2$
- (3)  $192 \text{ cm}^2$
- (4)  $256 \text{ cm}^2$

( )

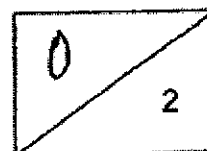

Questions 11 to 16 carry 2 marks each. Write your answers in the spaces provided. For questions which require units, give your answers in the units stated. (12 marks)

---

- 11 Write nine million, four hundred and sixty thousand and thirty in numerals.

Ans: \_\_\_\_\_

---

- 12 Express the product of  $\frac{1}{2}$  and  $\frac{19}{4}$  as a mixed number.

Ans: \_\_\_\_\_

---

- 13 Susie is 12 years old and Bob is 3 years older than her now. What is the total sum of their ages 9 years later?

Ans: \_\_\_\_\_

---

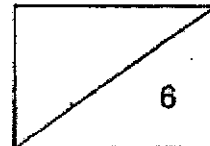

14 Ali needs to find a 5-digit secret code.

- The digit in the ones place is the first multiple of 6.
- The value of the digit 4 is 40 hundreds.
- The digit in the tens place is 3 less than the digit in the thousands place.
- The digit in the ten thousands place is thrice the digit in the tens place.
- The digit in the hundreds place is the sum of the digit in the tens place and the digit in the ones place.

What is the secret code?

Ans: \_\_\_\_\_

---

15 The total cost of a pen and 2 similar highlighters is \$6.50. The total cost of 2 such pens and 1 such highlighter is \$7. What is the cost of 5 such highlighters?

Ans: \$ \_\_\_\_\_

---

6

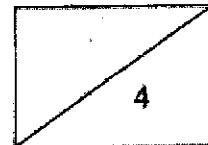

- 16 The rectangle below is made up of 4 triangles. The area of triangle WOZ is  $20 \text{ cm}^2$  and the area of triangle XOY is twice that of triangle WOZ. Given that line OF is 4 cm, find the area of triangle YOZ.

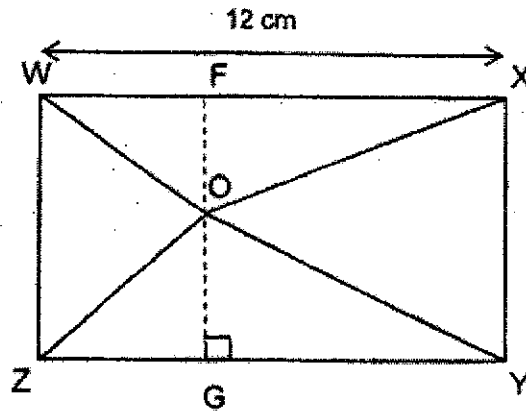

Ans: \_\_\_\_\_  $\text{cm}^2$

---

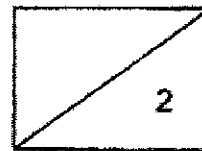

For Questions 17 and 18, show your workings clearly in the space below each question and write your answers in the spaces provided. The number of marks available is shown in brackets [ ] at the end of each question or part-question.  
(8 marks)

---

- 17 Aaron has  $\frac{3}{5}$  as much savings as Bob. If Bob gives \$40 to Aaron, they will have the same amount of money.

- a) How much money does Bob have?  
b) How much money do they have altogether?

Ans: a) \_\_\_\_\_ [2]  
b) \_\_\_\_\_ [2]

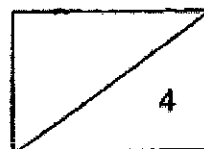



- 18 There were some children in a school hall. During recess,  $\frac{3}{7}$  of the boys and  $\frac{7}{9}$  of the girls left the hall. There was now an equal number of boys and girls in the hall. If 44 more girls than boys left the hall, how many children were there in the hall at first?

Ans: \_\_\_\_\_ [4]

---

**END OF PAPER**

9

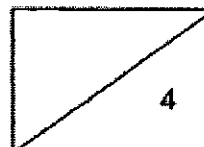



SCHOOL : RED SWASTIKA PRIMARY SCHOOL  
 LEVEL : PRIMARY 5  
 SUBJECT : MATH  
 TERM : 2021 WA1

PAPER 1 BOOKLET A

| Q 1 | Q2 | Q3 | Q4 | Q5 | Q6 | Q7 | Q8 | Q9 | Q10 |
|-----|----|----|----|----|----|----|----|----|-----|
| 4   | 1  | 3  | 1  | 2  | 1  | 4  | 1  | 2  | 3   |

|      |   |
|------|---|
| Q11) | 9460050   |
| Q12) | $\frac{1}{2} \times \frac{19}{4} = \frac{19}{8}$ $= 2\frac{3}{8}$   |
| Q13) | Susie 9 years later $\rightarrow 12 + 9 = 21$<br>Bob 9 years later $\rightarrow (12 + 3) + 9$<br>$= 15 + 9$<br>$= 24$<br>Total sum $= 24 + 21$<br>$= 45$  |
| Q14) | $40 \times 100 = 4000$<br>$4 - 3 = 1$<br>$1 \times 3 = 3$<br>$6 + 1 = 7$<br>Ans: 34716  |
| Q15) | $1 \text{ pen} + 2 \text{ highlighter} \rightarrow \$6.50$<br>$2 \text{ pen} + 1 \text{ highlighter} \rightarrow \$7$<br>$2 \text{ pen} + 4 \text{ highlighter} \rightarrow \$6.50 \times 2$<br>$= \$13$<br>$3h \rightarrow \$13 - \$7$<br>$= \$6$<br>$1h \rightarrow \$6 \div 3$<br>$= \$2$<br>$5h \rightarrow 5 \times \$2$<br>$= \$10$ |
| Q16) | Area of WOX $\rightarrow \frac{1}{2} \times 12 \times 40$<br>$= 6 \times 4$<br>$= 24\text{cm}^2$<br>Area of YOZ $\rightarrow (20 + 40) - 24$<br>$= 60 - 24$<br>$= 36\text{cm}^2$  |
| Q17) |   |

|      |   |   |  |  |  |  |  |  |      |  |  |   |  |  |  |  |  |  |  |  |      |
|------|---|---|--|--|--|--|--|--|------|--|--|---|--|--|--|--|--|--|--|--|------|
|      | <table border="1" style="margin-left: 20px;"> <tr> <td style="width: 20px;">A</td> <td style="width: 20px;"> </td> <td style="width: 20px;"> </td> <td style="width: 20px;"> </td> <td style="width: 20px;"> </td> <td style="width: 20px;"> </td> <td style="width: 20px;"> </td> <td style="width: 20px;"> </td> <td style="width: 20px;"> </td> <td style="width: 20px;"> </td> </tr> <tr> <td>B</td> <td> </td> <td> </td> <td> </td> <td> </td> <td> </td> <td> </td> <td> </td> <td> </td> <td>\$30</td> </tr> </table> <p>a)<br/> <math>1U \rightarrow \\$40</math><br/> Amount of money Bob has <math>\rightarrow \\$40 \times 5 = \\$200</math>.</p> <p>b)<br/> Amount of money altogether <math>\rightarrow 8 \times \\$40 = \\$320</math></p>  | A |  |  |  |  |  |  |      |  |  | B |  |  |  |  |  |  |  |  | \$30 |
| A    |   |   |  |  |  |  |  |  |      |  |  |   |  |  |  |  |  |  |  |  |      |
| B    |   |   |  |  |  |  |  |  | \$30 |  |  |   |  |  |  |  |  |  |  |  |      |
| Q18) | <p>No. of boys left <math>\rightarrow 1 - \frac{3}{7} = \frac{4}{7}</math><br/> No. of girls left <math>\rightarrow 1 - \frac{7}{9} = \frac{2}{9}</math><br/> <math>\frac{2}{9} = \frac{4}{18}</math></p> <p>Number of girls/boys left: <math>4U</math><br/> Number of boys at first: <math>7U</math><br/> Number of girls at first: <math>18U</math><br/> No of girls at left the hall: <math>18 \times \frac{7}{9}</math><br/> <math>= 14</math></p> <p><math>14 - 3 = 11</math><br/> <math>11U \rightarrow 44</math><br/> <math>1U \rightarrow 44 \div 11</math><br/> <math>= 4</math></p> <p><math>18U + 7U = 25U</math><br/> <math>25U \rightarrow 4 \times 25U</math><br/> <math>= 100</math></p> <p>Girls left = <math>18 - 14 = 4</math><br/> <math>25U: 4 \times 25U = 100</math><br/> Ans: 100 children</p> |   |  |  |  |  |  |  |      |  |  |   |  |  |  |  |  |  |  |  |      |