

Name : _____ ()

Class : Primary 5 _____

CHIJ ST NICHOLAS GIRLS' SCHOOL



Primary 5

Continual Assessment 1 – 2009

Mathematics

Paper I

Booklet A

2 MARCH 2009

15 QUESTIONS

20 MARKS

INSTRUCTIONS TO CANDIDATES

TOTAL TIME FOR PAPER 1 : 50 MINUTES

DO NOT OPEN THIS BOOKLET UNTIL YOU ARE TOLD TO DO SO.

FOLLOW ALL INSTRUCTIONS CAREFULLY.

ANSWER ALL QUESTIONS. YOU ARE NOT ALLOWED TO USE A CALCULATOR.

This paper consists of 6 printed pages including the cover page.

Booklet A: Multiple Choice Questions (20 marks)

Questions 1 to 10 carry 1 mark each. Questions 11 to 15 carry 2 marks each.

For each question, four options are given. One of them is the correct answer. Make your choice (1, 2, 3 or 4). Shade the correct oval (1, 2, 3, 4) on the Optical Answer Sheet (OAS).

1) $835\ 078 = 800\ 000 + \boxed{?} + 70 + 8$. What is the missing number in the box?

1) 350 tens

2) 350 thousands

3) 3500 ones

4) 3500 tens

2) The difference between the values of the digits '3' and '5' in $4\overset{\circ}{3}6\overset{\circ}{1}50$ is _____

1) 2

2) 29 950

3) 35 950

4) 36 100

3) Which one of the following numbers has the digit '4' in the hundred thousands place?

1) 1 204 680

2) 2 583 490

3) 4 507 123

4) 8 473 256

4) The number of wild animals in a country is two million when the number is rounded off to the nearest hundred thousand. What is the largest possible actual number of wild animals in the country?

1) 2 000 049

2) 2 000 499

3) 2 004 099

4) 2 040 099

5) 64×48 is the same as _____.

~~1) $64 \times 40 \times 8$~~

2) $64 \times 8 \times 6$

3) $64 + 40 \times 8$

4) $64 \times 40 + 8$

6) What is the value of $3 + 7 \times 50 - 40 \div 10$?

1) 10

2) 46

3) 349

4) 496

7) Find the difference between $\frac{7}{8}$ and $\frac{1}{4}$

1) $\frac{6}{8}$

2) $\frac{5}{8}$

3) $\frac{3}{4}$

4) $\frac{1}{2}$

8) Ashley had $\frac{9}{10}$ ℓ of orange juice. She used $\frac{3}{4}$ ℓ to make mixed fruit juice.
How much orange juice was left?

1) $\frac{3}{20}$ ℓ

2) $\frac{1}{2}$ ℓ

3) $\frac{27}{40}$ ℓ

4) $\frac{33}{40}$ ℓ

- 9) The perimeter of the following rectangle is 76 cm. Find its length.



- | | |
|----------|----------|
| 1) 14 cm | 2) 24 cm |
| 3) 28 cm | 4) 48 cm |

- 10) Which of the following shapes can be tessellated?

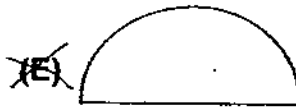
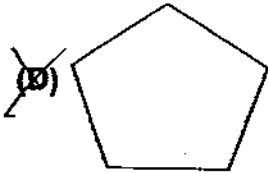
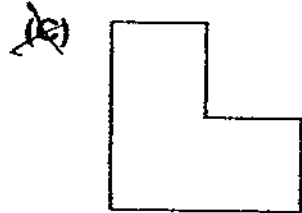
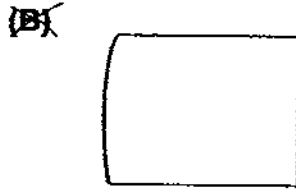
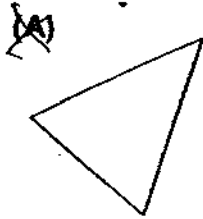

~~1) A, C and F only~~

~~2) A, D and F only~~

~~3) B, D and E only~~

~~4) B, D and F only~~

11) What is the value of $84\,520 - (123 - 19) \times 4$ when round off to the nearest 1000?

1) 80 000

2) 84 000

3) 84 100

4) 84 700

12) There were 225 chairs in each of the 3 rows in a hall. Kelvin brought in 40 more chairs and rearranged all of them into 5 rows. Which number sentence below will give the number of chairs in each row?

1) $225 \times 3 + 40 \div 5$

2) $(225 \times 3) + 40 \div 5$

3) $(225 \times 3 + 40) \div 5$

4) $(225 \times 3) + (40 \div 5)$

13) For every bottle of perfume sold, Jessie gets \$13. She also gets an extra \$15 for every 9 bottles sold. How much money will she get if she sells 100 bottles of perfume?

1) \$ 1417

2) \$ 1435

3) \$ 1465

4) \$ 1480

14) Mrs Cook had $\frac{5}{6}$ kg of margarine. She used $\frac{1}{3}$ kg to bake pineapple tarts and $\frac{1}{12}$ kg to bake some biscuits. How much margarine had she left?

1) $\frac{5}{12}$ kg

2) $\frac{7}{12}$ kg

3) $1\frac{1}{12}$ kg

4) $1\frac{1}{4}$ kg

15) Rectangle A has a length of 9 cm and an area of 117 cm^2 . Its perimeter is four times the perimeter of Rectangle B. Find the perimeter of Rectangle B.

1) 11 cm

2) 22 cm

3) 44 cm

4) 176 cm

Name : _____ ()

Class : Primary 5 _____

CHIJ ST NICHOLAS GIRLS' SCHOOL



Primary 5

Continual Assessment 1 – 2009

Mathematics

Paper I

Booklet B

2 MARCH 2009

15 QUESTIONS

20 MARKS

INSTRUCTIONS TO CANDIDATES

TOTAL TIME FOR PAPER 1 : 50 MINUTES

DO NOT OPEN THIS BOOKLET UNTIL YOU ARE TOLD TO DO SO.

FOLLOW ALL INSTRUCTIONS CAREFULLY.

ANSWER ALL QUESTIONS. YOU ARE NOT ALLOWED TO USE A CALCULATOR.

This paper consists of 8 printed pages including the cover page.

Booklet B: Short Answers (20 marks)

Questions 16 to 25 carry 1 mark each.
Questions 26 to 30 carry 2 marks each.

Write down your answers in the answer blanks provided. Give your answers in the units stated.

16) Write 9 498 014 in words.

Ans : _____

17) Arrange the numbers in order, beginning with the greatest.

2 968 000, 2 980 760, 980 657, 2 987 053

Ans : _____

18) What is the smallest 6-digit number greater than 500 000 that can be formed with the digits 7, 1, 3, 4, 0, 6?

Ans: _____

Do not
write in
this space



19) In $57 \times 76 = 19 \times \boxed{?} \times 38$, what is the missing number?

Ans: _____

20) Damien has \$ 5780. He spends \$ 189 every day for 4 weeks. How much has he left after 4 weeks?

Ans: \$ _____

21) There are 450 children in a music school. 275 of them are boys. What fraction of the children are girls?

Ans: _____

Do not
write
this:



- 22) Christabella had some icing sugar in a container. After she used $\frac{3}{8}$ kg of it, she had $\frac{4}{7}$ kg left. How much icing sugar was in the container at first?

Do not write in this space

Ans: _____ kg

- 23) The figure below is made up of a rectangle and a square. Find the area of the figure.

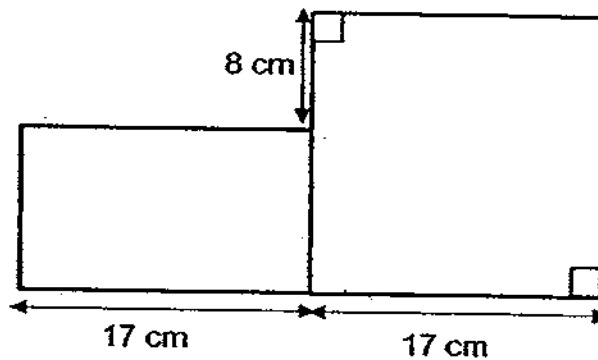

Ans: _____ cm²

- 24) The pattern in the box shows part of a tessellation. Shade the 2 unit shapes which have been tessellated wrongly.

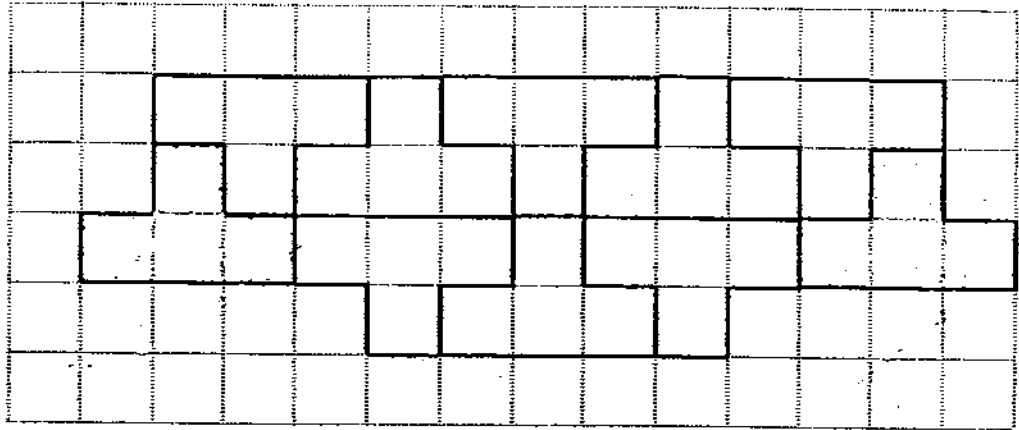

- 25) The sum of 2 numbers is 2085. The difference between these 2 numbers is 203. What are the 2 numbers?

Ans: _____ and _____

Do not
write in
this sp



- 26) There were four times as many horses as donkeys. The number of goats was twice the number of horses. If there were 288 goats, how many more horses than donkeys were there?

Do not
write in
this sp.

Ans: _____

- 27) Shade 2 more squares to make the figure symmetric.

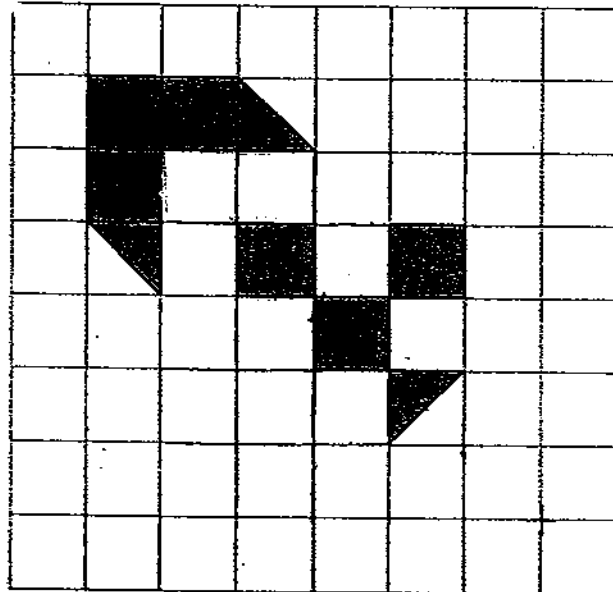

- 28) Given that the figures below have the same area, find the perimeter of EFGH.

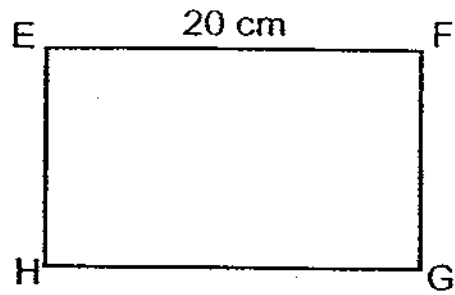
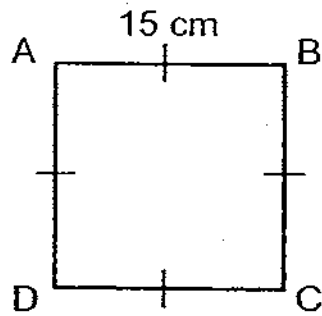

Do not
write in
this sp

Ans: _____ cm

- 29) Add $\frac{11}{12}$ to the difference between $\frac{7}{8}$ and $\frac{3}{4}$.

Ans: _____

30) What should be added to the sum of $\frac{3}{5}$ and $\frac{1}{6}$ to make 3?

Do not
write in
this space

Ans: _____

End of Paper 1

Name : _____ ()

Class : Primary 5 _____

CHIJ ST NICHOLAS GIRLS' SCHOOL



Primary 5

Continual Assessment 1 – 2009

Mathematics

Paper 2

2 MARCH 2009

Parent's Signature

18 QUESTIONS
60 MARKS

INSTRUCTIONS TO CANDIDATES

TOTAL TIME FOR PAPER 2 : 1 HOUR 40 MINUTES

DO NOT OPEN THIS BOOKLET UNTIL YOU ARE TOLD TO DO SO.

FOLLOW ALL INSTRUCTIONS CAREFULLY.

ANSWER ALL QUESTIONS. YOU ARE ALLOWED TO USE A CALCULATOR.

This paper consists of 14 printed pages including the cover page.

Paper 1 Booklet A	20
Paper 1 Booklet B	20
Paper 2	60
Total	100

Short Answers (10 marks)

Questions 31 to 35 carry 2 marks each.

Write your answers in the answer blanks provided.
Give your answers in the units stated.

- 31) Francesca wants to shade $\frac{3}{4}$ of the rectangle. How many more triangles must she shade?

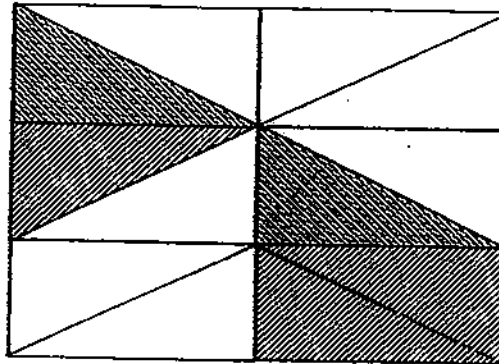

Ans : _____

- 32) When Kathie multiplied a certain number by 8, her answer was 3000 when rounded off to the nearest 1000. What was the greatest possible whole number that Kathie used?

Ans : _____

Do not
write in
this space



- 33) Mrs Gopal planned to distribute 509 strawberries equally among 42 children. If she were to change her mind and give each child 3 fewer strawberries, how many strawberries would she have left?

Do not
write in
this sp:

Ans : _____

- 34) The area of the shaded squares is 224 cm^2 . Find the perimeter of the unshaded part of the figure.

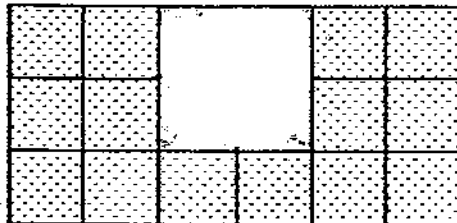

Ans : _____ cm

- 35) In the diagram below, the points A, B, C and D are in the centre of each side of the big square. Find the area of the shaded region.

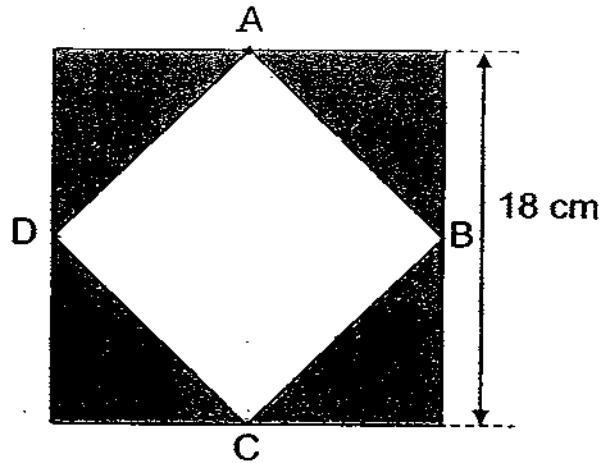

Ans : _____ cm^2

Do not
write in
this spa



Long Answers (50 marks)

For questions 36 to 48, show your working clearly in the space below each question and write your answer in the spaces provided. The number of marks available is shown in the brackets () at the end of each question or part-question.

Do not
write in
this space.

- 36) Sammy baked 258 bacon rolls and some fruit pies. He sold all the bacon rolls at 85¢ each and all the fruit pies at 95¢ each. If he collected a total amount of \$298.15, how many fruit pies did he sell?

Ans: _____ (3 m)

- 37) Benedict painted 123 chairs. This was thrice as many as the total number of chairs painted by Eugene and Daniel. If Eugene painted 27 chairs, how many more chairs did Benedict paint than Daniel?

Ans: _____ (3 m)

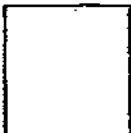

- 38) 2 notebooks and 3 files cost \$19. Each notebook costs \$1.50 less than each file. What is the total cost of a notebook and 2 files?

Do not
write in
this space

Ans: _____ (3 m)

- 39) Dino and Ethan have a total of 489 cards. Brad and Dino have 174 cards altogether. Ethan has 6 times as many cards as Brad. How many cards does Dino have?

Ans: _____ (3 m)

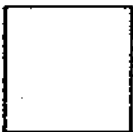

- 40) Mrs Rosemary had some jellybeans. If she gave 4 jellybeans to each of her pupils in her class, she would have 7 jellybeans left. If she gave 3 jellybeans to each of them, she would have 32 left. How many jellybeans did Mrs Rosemary have?

Do not
write in
this space.

Ans: _____ (3 m)

- 41) Meimei used $\frac{7}{8}$ m of cloth to make a pencil case and $\frac{2}{3}$ m less to make a pouch to match her skirt. How much cloth did she use in all?

Ans: _____ (3 m)



- 42) Two strings, Y and Z, were each cut into 4 equal pieces. Each small piece of Y was $\frac{2}{3}$ m long. It was $\frac{1}{12}$ m longer than each small piece of Z. What is the difference between the total length of Y and the total length of Z?

Do not
write in
this space

Ans: _____ (4 m)



- 43) A tin contains chocolate-chip cookies, macadamia nut cookies and crunchy nut cookies. $\frac{7}{16}$ of them are chocolate-chip cookies and 120 of the cookies are macadamia nut cookies. Given that the macadamia nut cookies are $\frac{1}{4}$ of all the cookies, how many crunchy nut cookies are there?

Do not
write in
this space.

Ans: _____ (4 m)

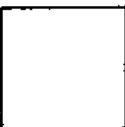

44) The perimeter of a rectangular garden is 156 m. Its breadth is 13 m.

(a) Find its length.

(b) Find the cost of tuffing it with carpet grass at \$21 per m^2 .

Do not
write in
this space

Ans: (a) _____ (2 m)



(b) _____ (2 m)



45)

SPECIAL OFFER!

Buy 7 T-shirts, get 1 umbrella free.



Do not
write in
this spa

On a particular day, there were 8 customers who bought the T-shirts. A total of 12 umbrellas were given to 6 of them. Each T-shirt was sold at \$14.50 and the total amount paid by the 8 customers was \$ 1363. If each of the other two customers who did not receive any free umbrellas bought an equal number of T-shirts, how many T-shirts did each of the two customers buy?

Ans: _____ (5 m)

- 46) A grocer packs 244 kg of rice into 5-kg and 2-kg bags of rice. If the grocer has 4 more 5-kg bags than 2-kg bags of rice, how many bags of rice does he have in all?

Do not
write in
this space

Ans: _____ (5 m)



- 47) Marcus cut a piece of wire into 3 pieces. He bent them to form Rectangle P, Rectangle Q and Square R as shown below. The area of R is 479 cm^2 less than the total area of P and Q. Find the length of the original piece of wire.

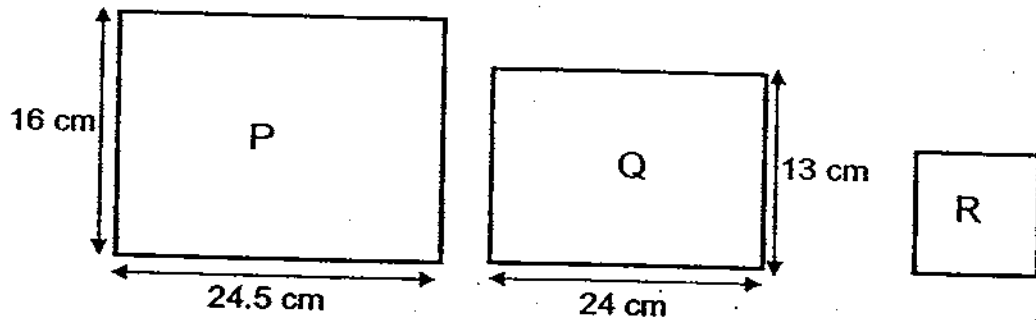

Do not write in this space.

Ans: _____ (5 m)

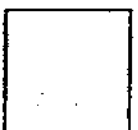

- 48) Lucas and Amos had the same amount of money. Lucas spent \$ 220 while Amos spent \$112. Lucas had $\frac{1}{4}$ of the total amount both of them had left. How much money did they have altogether at first?

Do not
write in
this space

Ans: _____ (5 m)

----- End Of Paper -----

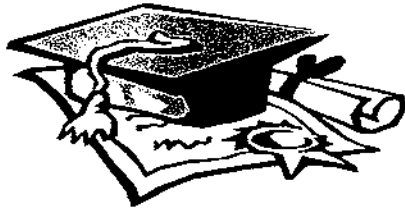

ANSWER SHEET

EXAM PAPER 2009

**SCHOOL : CHIJ PRIMARY
SUBJECT : PRIMARY 5 MATHEMATICS**

TERM : CA1

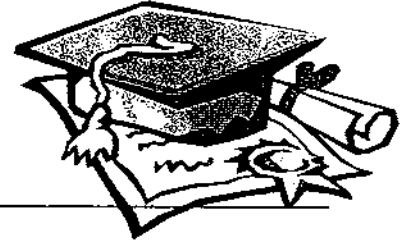

Q1	Q2	Q3	Q4	Q5	Q6	Q7	Q8	Q9	Q10	Q11	Q12	Q13	Q14	Q15
4	2	4	4	2	3	2	1	2	1	2	3	3	1	1

16) Nine million, four hundred and ninety-eight thousand and fourteen.

17) 2987053, 2980760, 2968000, 980657

18) 601347

19) 6

20) \$488

21) 7/18

22) 53/56

23) 442

24)

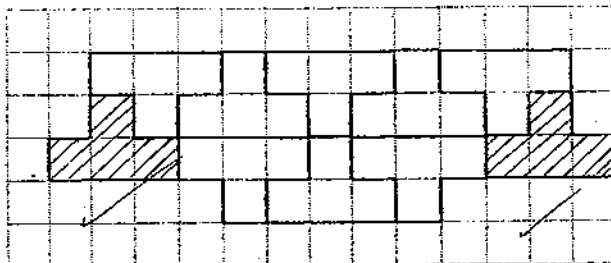

25) 941 and 1144

26) 108

27)

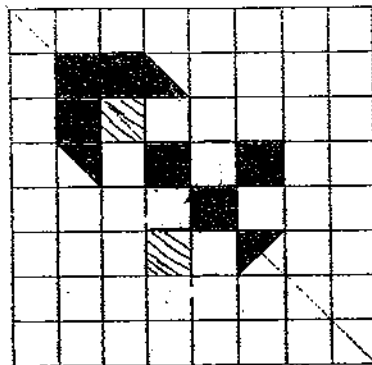

28) 62.5cm

29) 11/14

30) 27/30

31) 4 triangles

32) 437

33) 131 strawberries

34)32cm 35)18x9=162cm² 36)83 fruit pies

37)123 ÷ 3 = 41

41 - 27 = 14

123 - 14 = 109

Benedict painted 109 chair more than Daniel.

38)\$11.70

39)111 cards

40)107 pupil

41)1 1/12m

42)1/3m

43)150 cookies

44)a)65m b)\$17745

45)5 shirts

46)68 bags

47)215cm

48)548