



NAN HUA PRIMARY SCHOOL  
SEMESTRAL ASSESSMENT 1 – 2017  
PRIMARY 5

MATHEMATICS

Paper 1

Section A: 15 Multiple Choice Questions (20 marks)

Section B: 15 Short Answer Questions (25 marks)

Total Time for Paper 1: 1 Hour

INSTRUCTION TO CANDIDATES

1. Write your name and index number in the space provided.
2. Do not turn over the page until you are told to do so.
3. Follow all instructions carefully.
4. Answer all questions.
5. Shade your answers in the Optical Answer Sheet (OAS) provided for Questions 1-15.
6. You are not allowed to use calculator for Paper 1.

Marks Obtained

Paper 1	Booklet A		/ 45
	Booklet B		
Paper 2			/ 55
Total			/ 100

Name : \_\_\_\_\_ ( )

Class : 5 \_\_\_\_\_

Date : 9 May 2017      Parent's Signature : \_\_\_\_\_

**Section A (20 marks)**

Questions 1 to 10 carry 1 mark each. Questions 11 to 15 carry 2 marks each.  
For each question, four options are given. One of them is the correct answer.  
Make your choice and shade your answer (1, 2, 3 or 4) on the Optical Answer Sheet.

---

1. Which of the following has the digit "5" in the hundred thousands place?

- (1) 3 652 148
- (2) 5 907 346
- (3) 6 415 092
- (4) 8 520 408

2. The cost of a set of television is \$1 459. Round the cost of the set of television to the nearest hundred dollars.

- (1) \$ 1 400
- (2) \$ 1 460
- (3) \$ 1 500
- (4) \$ 1 550

3. Which of the following is **not** symmetrical?



4.  $2\frac{1}{4} \times 3 =$  \_\_\_\_\_ quarters

- (1) 6
- (2) 7
- (3) 21
- (4) 27

5. Find the value of  $\frac{5}{6} - \frac{1}{4}$

- (1)  $\frac{1}{3}$
- (2)  $\frac{1}{6}$
- (3)  $\frac{3}{4}$
- (4)  $\frac{7}{12}$

6. There are 90 prefects. 42 of these prefects wear spectacles. What is the ratio of the number of prefects who do not wear spectacles to the number of prefects who wear spectacles?

- (1) 7 : 8
- (2) 8 : 7
- (3) 7 : 15
- (4) 8 : 15

7. What is the area of the shaded triangle?

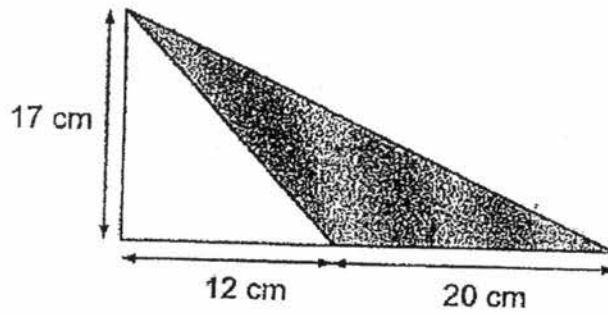

- (1) 102 cm<sup>2</sup>
- (2) 170 cm<sup>2</sup>
- (3) 272 cm<sup>2</sup>
- (4) 340 cm<sup>2</sup>

8. Daryl had  $\frac{2}{7}$  of his salary left after spending \$500. What was his salary?

- (1) \$ 700
- (2) \$ 1 250
- (3) \$1 000
- (4) \$1 750

9. What is the missing number in the box?

$$18 : 30 = \boxed{?} : 40$$

- (1) 28
- (2) 24
- (3) 3
- (4) 9

10. 9 tenths is \_\_\_\_\_ hundredths more than 0.4

(1) 500

(2) 50

(3) 5

(4) 0.5

11. 25 pots of plants were placed in a row at equal distance apart. The distance between the 1<sup>st</sup> and the 5<sup>th</sup> pot was 240 cm. What was the distance between the 1<sup>st</sup> and the 25<sup>th</sup> pot of plant?

(1) 1 152 cm

(2) 1 200 cm

(3) 1 440 cm

(4) 1 500 cm

12. A bus can either carry 40 children or 24 adults. If there are already 15 children in the bus, what is the maximum number of adults that can be in the bus?

(1) 15

(2) 9

(3) 3

(4) 6

13. The ratio of the length of Square A to the length of Square B is 3 : 4.  
If the length of Square A is 12 cm, what is the perimeter of Square B ?

- (1) 16 cm
- (2) 36 cm
- (3) 48 cm
- (4) 64 cm

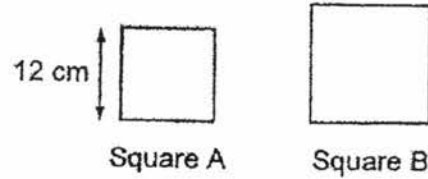

14. The pattern below is formed with the following pictures.



1st

What is the 80<sup>th</sup> picture in the pattern?

- (1)
- (2)
- (3)
- (4)

15. The figure below is made up of 2 similar triangles and 6 similar rectangles.  
What is the ratio of the unshaded part to the whole figure?

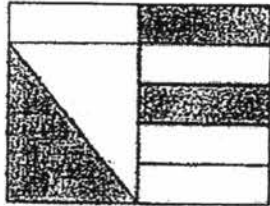

- (1) 2 : 3  
(2) 2 : 5  
(3) 3 : 2  
(4) 3 : 5

**Section B (25 marks)**

Questions 16 to 20 carry 1 mark each. Write your answers in the spaces provided. For questions which require units, give your answers in the units stated.

Do not write  
in this space

16. Find the product of  $\frac{3}{7}$  and  $\frac{7}{10}$

Ans: \_\_\_\_\_

17. Express  $2\frac{6}{25}$  as a decimal.

Ans: \_\_\_\_\_

18. Express 18 cm out of 3 m as a fraction in the simplest form.

Ans: \_\_\_\_\_



19. 5 children shared 8 pizzas. What fraction of the pizzas did each child get?

Do not write  
in this space

Ans: \_\_\_\_\_

20. How many more triangles must be shaded so that  $\frac{3}{4}$  of the figure below is shaded?

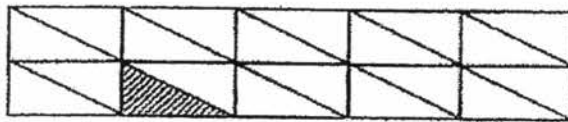

Ans: \_\_\_\_\_

Questions 21 to 30 carry 2 marks each. Show your working clearly in the space provided for each question and write your answers in the spaces provided. For questions which require units, give your answers in the units stated.

Do not write in this space

21. In the number line below, find the fraction exactly halfway between  $\frac{1}{3}$  and  $\frac{1}{2}$ .

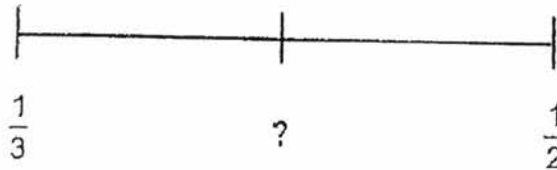

Ans: \_\_\_\_\_

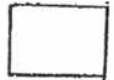

22. Mrs Rosna had a piece of cloth 60 m long. She used  $\frac{2}{5}$  of it to make cushion covers and  $\frac{1}{3}$  of it for some dresses. How much of the cloth was left?

Ans: \_\_\_\_\_ m

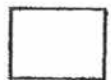

23. Sally is 11 years old. Janice is 15 years old. Find the ratio of Sally's age to Janice's age in 5 years' time. (Give your answer in the simplest form.)

Do not writ  
in this spat

Ans: \_\_\_\_\_

24. Find the perimeter of the figure below. (Figure is not drawn to scale.)

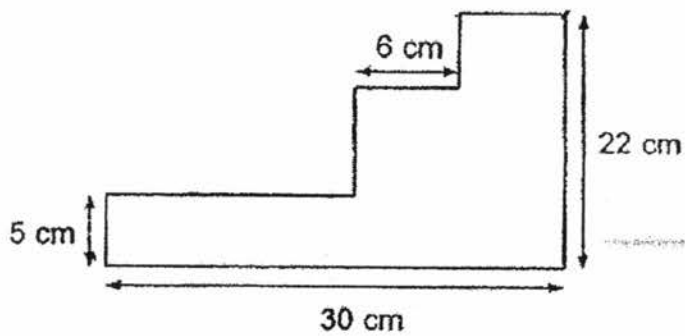

Ans: \_\_\_\_\_ cm

25. Wei Ming spent  $\frac{2}{5}$  of his pocket money on clothes and  $\frac{5}{6}$  of the remainder on food and transport. He had \$220 left in the end. What was his pocket money at first?

Do not write  
in this space

Ans: \$ \_\_\_\_\_

26. The ratio of the number of fruit tarts to the number of egg tarts baked was 9 : 5. If there were 124 more fruit tarts baked than egg tarts, how many egg tarts were baked?

Ans: \_\_\_\_\_

27. Luke cut his birthday cake into quarters. He then cut one of the quarters into 3 equal pieces. His uncle ate 2 of the smaller pieces of the cake. What fraction of his birthday cake was left? Give your answer in its simplest form.

Do not write  
in this space

Ans: \_\_\_\_\_

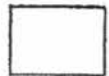

28. Figure ABCD, not drawn to scale, is made up of one square and two rectangles. The figure has a perimeter of 206 cm. What is the value of  $x$ ?

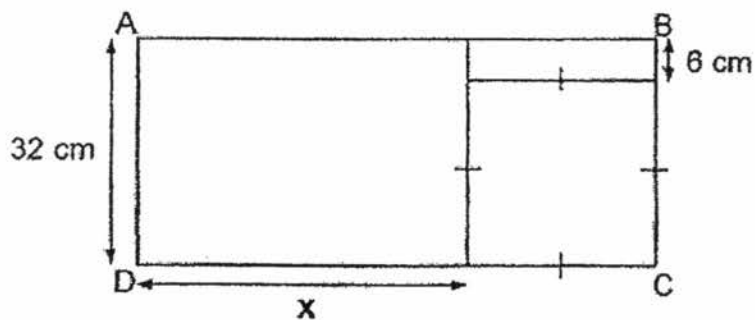

Ans: \_\_\_\_\_ cm



29. The figure below is made up of Square ABCD and Square EFGH. EFGH are the midpoints of Square ABCD. Find the ratio of the area of the Square EFGH to the area of Square ABCD.

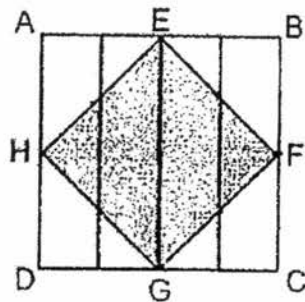

Ans: \_\_\_\_\_

Do not writ  
in this spac

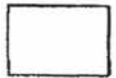

30. Mr Lim bought an equal number of key chains and notebooks.  
He gave  $\frac{1}{4}$  of the key chains and  $\frac{5}{6}$  of the notebooks to his students.  
He gave 21 more notebooks than keychains. How many key chains and notebooks did Mr Lim buy altogether?

Ans: \_\_\_\_\_

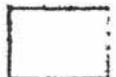

END OF PAPER 1



NAN HUA PRIMARY SCHOOL  
SEMESTRAL ASSESSMENT 1 – 2017  
PRIMARY 5

MATHEMATICS

Paper 2

Total Time for Paper 2: 1 hour 30 minutes

5 Short Answer Questions (10 marks)

12 Structured / Long Answer Questions (45 marks)

INSTRUCTION TO CANDIDATES

1. Write your name and index number in the space provided.
2. Do not turn over the page until you are told to do so.
3. Follow all instructions carefully
4. Answer all questions and show your workings clearly.
5. You are allowed to use a calculator.

Marks Obtained

Total		/ 55
-------	--	------

Name : \_\_\_\_\_ (     )

Class : 5 \_\_\_\_\_

Date : 9 May 2017

Parent's Signature : \_\_\_\_\_

**Paper 2 (55 marks)**

Questions 1 to 5 carry 2 marks each. Show your workings clearly and write your answer in the space provided. For questions which require units, give your answers in the units stated. (10 marks)

Do not write  
in this space

1. Write 364 912 in words.

---

---

2. Write down all the factors of 27.

Ans: \_\_\_\_\_

3. Share 390 oranges equally among 9 people..

- a) How many oranges will each person get?  
b) How many oranges will be left over?

Ans: (a) \_\_\_\_\_

(b) \_\_\_\_\_



Do not write  
in this space

4. Jane saved \$183.60. She donated  $\frac{5}{6}$  of her savings to charity.

How much money did she donate?

Give your answer to the nearest ten dollar.

Ans: \$ \_\_\_\_\_

5. Joyce and Tina had an equal amount of money  
Each day, Joyce spent \$24 and Tina spent \$28.  
When Tina spent all her money, Joyce still had \$64 left.  
In how many days did Tina spend all her money?

Ans: \_\_\_\_\_

For questions 6 to 17, show your working clearly and write your answers in the spaces provided. The number of marks available is shown in brackets [ ] at the end of each question or part-question. (45 marks)

Do not write  
in this space

6. 20 children share some cards equally. When another child joins them, they each get 2 fewer cards. How many cards are they sharing altogether?

Ans: \_\_\_\_\_ [3]

7. There is a total of 43 bicycles and tricycles.  
There is a total of 111 wheels. How many tricycles are there?



Ans: \_\_\_\_\_ [3]

8. 3 books and 2 files cost \$78.  
1 book and 3 files cost \$40.  
What was the cost of a book?

Do not write  
in this space

Ans: \_\_\_\_\_ [3]

9. There were 8 times as many pupils as teachers in a school event.  
There were 3 times as many girls as boys.  
There were 70 fewer teachers than girls.  
How many people were at the event?

Ans: \_\_\_\_\_ [3]

10. In the figure below (not drawn to scale),  $AD = DC$  and the area of triangle  $ABC$  is  $120 \text{ cm}^2$ . Find the area of (a) triangle  $AEC$  and (b) triangle  $DEC$ .

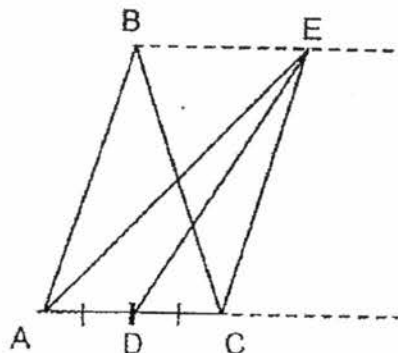

Ans:(a) \_\_\_\_\_ [1]

(b) \_\_\_\_\_ [2]

Do not write  
in this space

11. There was  $60 \text{ ml}$  of water in beaker A and  $100 \text{ ml}$  of water in beaker B.
- (a) Find the ratio of volume of water in beaker A to beaker B.
- (b) After some water was added to both beakers, beaker A had  $90 \text{ ml}$  of water. The ratio of volumes of water in both beakers remained the same. How much water was added to beaker B?

Ans: (a) \_\_\_\_\_ [1]

(b) \_\_\_\_\_ [3]

12. ACDF is a rectangle. AFE and BCD are both identical triangles.  
 The ratio of the length of DC to the length of DE is 2 : 5  
 Find the area of the shaded part.

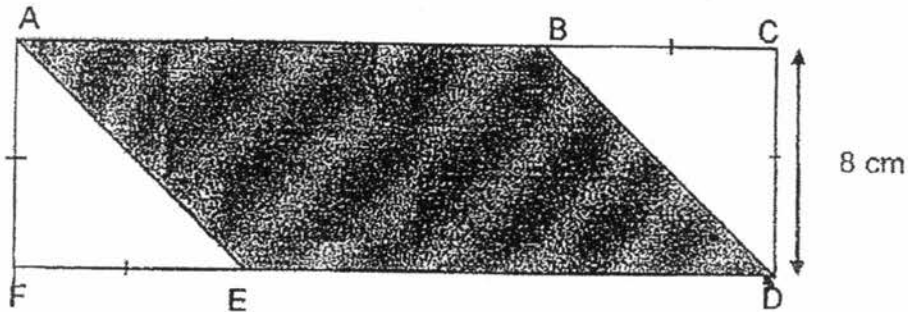

Do not write  
 in this space

Ans: \_\_\_\_\_ [4]

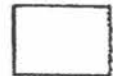

13. Sue had some blue and red beads. She sold an equal number of blue and red beads. She had  $\frac{2}{5}$  of the blue beads and  $\frac{3}{4}$  of the red beads left. What fraction of the beads she had were not sold?

Ans: \_\_\_\_\_ [4]

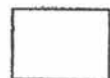

Do not write  
in this space

14. There were 20 questions in a test.

For every question answered correctly, 2 points were awarded.

For every question answered incorrectly, 1 point was deducted.

Jeremy scored 31 points. How many questions did he answer correctly?

Ans: \_\_\_\_\_ [4]

15. Teddy and Lynn had some seashells each. If Teddy gave Lynn 150 seashells, both would have an equal number of seashells. If Lynn gave Teddy 150 seashells, Teddy would have 3 times as many seashells as Lynn. How many seashells did Lynn have at first?

Ans: \_\_\_\_\_ [4]

16. Study the diagram below which are made up of squares.

Figure 1 has a perimeter of 40 cm.

Do not write  
in this space

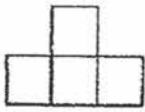

Figure 1

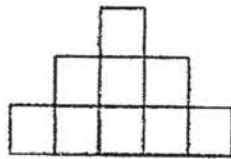

Figure 2

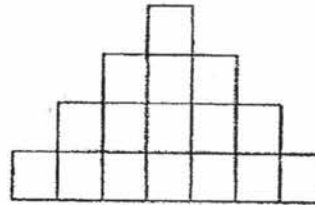

Figure 3

Complete the table below by filling in the blank.

Figure	Number of sides of figures	Perimeter
Figure 1	10	40 cm
Figure 2	16	64 cm
Figure 3	22	a) ?
Figure 4	b) ?	c) ?

d) Which figure will give a perimeter of 304 cm?

Ans: (a) \_\_\_\_\_ [1]

(b) \_\_\_\_\_ [1]

(c) \_\_\_\_\_ [1]

(d) \_\_\_\_\_ [2]



17. In the figure, ABCD is a rectangle.

The area of EGCD is  $\frac{5}{9}$  of the area of triangle DFC.

It is also  $\frac{4}{5}$  of the area of rectangle ABCD.

The area of the whole figure is  $492 \text{ cm}^2$

What is the area of triangle EFG?

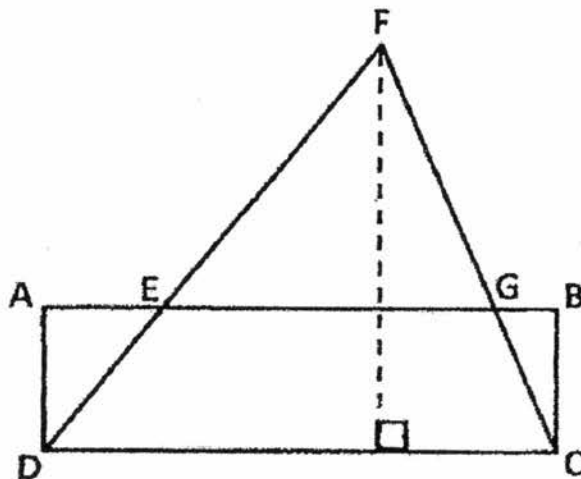

Do not write  
in this space

Ans: \_\_\_\_\_ [5]

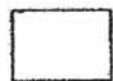

End - of - Paper



EXAM PAPER 2017 (P5)

SCHOOL : NAN HUA

SUBJECT : MATHEMATICS

TERM : SA1

Q1	Q2	Q3	Q4	Q5	Q6	Q7	Q8	Q9	Q10
4	3	2	4	4	2	2	1	2	2
Q11	Q12	Q13	Q14	Q15					
3	1	4	1	4					

16)  $3/7 \times 7/10 = 3/10$

17)  $26/25 \times 4 = 224/100 = 2.24$

18)  $18/300 \div 3 = 6/100 \div 2 = 3/50$

19)  $8 \div 5 = 8/5 = 1\frac{3}{5}$

20)  $\frac{3}{4} \times 5 = 15/20$

$15 - 1 = 14$

21)  $1/3 + 1/2 = 2/6 + 3/6 = 5/6$

$5/6 \div 2/1 = 5/6 \times 1/2 = 5/12$

$$22) 60 \div 15 = 4$$

$$6/15 + 5/15 = 11/15$$

$$15/15 - 11/15 = 4/15$$

$$4 \times 4 = 16M$$

$$23) 11 + 5 = 16 \rightarrow S$$

$$15 + 5 = 20 \rightarrow J$$

$$16 : 20$$

$$= 4 : 5$$

$$24) 30 + 30 + 22 + 22 = 104cm$$

$$25) 1u \rightarrow 220$$

$$10u \rightarrow 220 \times 10 = \$2200$$

$$26) 9 - 5 = 4$$

$$124 \div 4 = 31$$

$$31 \times 5 = 155$$

$$27) 4 \times 3 = 12$$

$$12 - 2 = 10$$

$$10/12 \div 2 = 5/6$$

$$28) 32 + 32 = 64$$

$$206 - 64 = 142$$

$$142 \div 2 = 71$$

$$32 - 6 = 26$$

$$71 - 26 = 45cm$$

$$29) 1 : 2$$

$$30) \frac{1}{4} \times 3 = 3/12$$

$$\frac{5}{6} \times 2 = 10/12$$

$$\text{total} \rightarrow 12u$$

$$\text{Gave} \rightarrow 3u$$

$$\text{Left} \rightarrow 9u$$

$$10 - 3 = 7$$

$$7u = 21$$

$$1u = 21 \div 7 = 3$$

$$24u = 3 \times 24 = 72$$

## Paper 2

1) Three hundred and sixty-four thousand, nine hundred and twelve.

2)  $27 = 1 \times 27$

$3 \times 9$

Ans: 1,3,9,27

3)a)  $390 \div 9 = 43 \text{ R}3$

b) R3

4)  $6u = 183.60$

$1u = 183.60 \div 6 = 30.60$

$5u = 30.60 \times 5 = \$153 \approx \$150$

5)  $28 - 24 = 4$

$64 \div 4 = 16 \text{ days}$

6)  $20 \times 2 = 40$

$20 + 1 = 21$

$21 \times 40 = 840$

7)

No of bic	No.of wheels (bic)	No.of tric	No.of wheels (tric)	Total no.of whels	Check (x/ √)
22	$22 \times 2 = 44$	21	$21 \times 3 = 63$	$63 + 44 = 107$	X
19	$19 \times 2 = 38$	24	$24 \times 3 = 72$	$72 + 38 = 110$	X
18	$18 \times 2 = 36$	<u>25</u>	$25 \times 3 = 75$	$75 + 36 = 111$	√

Ans: 25

$$8) 3B + 2F = 78$$

$$1B + 3F = 40$$

$$9B + 6F = 234$$

$$2B + 6F = 80$$

$$7B = 234 - 80 = 154$$

$$1B = 154 \div 7 = \$22$$

$$9) 5u \rightarrow 70$$

$$1u \rightarrow 70 \div 5 = 14$$

$$9u \rightarrow 14 \times 9 = 126$$

$$10) a) 120 \text{cm}^2$$

$$b) 120 \div 2 = 60 \text{cm}^2$$

$$11) a) 60 : 100$$

$$3 : 5$$

$$b) 3u = 90$$

$$1u = 90 \div 3 = 30$$

$$5u = 30 \times 5 = 150$$

$$150 - 100 = 50 \text{ml}$$

$$12) 2u = 8$$

$$1u = 8 \div 2 = 4$$

$$5u = 4 \times 5 = 20$$

$$20 \times 8 = 160 \text{cm}^2$$

$$13) 11/17$$

$$14) 20 \times 2 = 40$$

$$40 - 31 = 9$$

$$2 + 1 = 3$$

$$9 \div 3 = 3$$

$$20 - 3 = 17$$

$$15) 2u = 150 + 150 + 150 + 150 = 600$$

$$1u = 600 \div 2 = 300$$

$$300 + 150 = 450$$

$$16) a) 22 \times 4 = 88 \text{ cm}$$

$$b) 22 + 6 = 28$$

$$c) 28 \times 4 = 112 \text{ cm}$$

$$d) (N \times 6 + 4) \times 4 = 304$$

$$(N \times 6 + 4) = 304 \div 4 = 76$$

$$N \times 6 = 76 - 4 = 72$$

$$N = 72 \div 6 = 12$$

$$17) 36 - 20 = 16 \text{ (EFG)}$$

$$25 - 20 = 5$$

$$41u = 492$$

$$1u = 492 \div 41 = 12$$

$$16u = 12 \times 16 = 192 \text{ cm}^2$$