

**Tao Nan School**  
**Primary 5 Mathematics End-of-Year Examination – 2009**

Name: \_\_\_\_\_ ( )

Date : 28 October 2009

Class : Primary 5 ( )

Parent's Signature : \_\_\_\_\_

Marks: \_\_\_\_\_ / 100

Paper 1 comprises 2 booklets, A and B. Time: 8.00 a.m. – 8.50 a.m.

**MATHEMATICS**

**PAPER 1**

**(BOOKLET A)**

**INSTRUCTIONS TO CANDIDATE**

1. Write your name, class and Index No.
2. Do not turn over this page until you are told to do so.
3. Follow all instructions carefully.
4. Answer all questions.
5. Shade your answers in the Optical Answer Sheet (OAS) provided.
6. You are **not** allowed to use a calculator.

Questions 1 to 10 carry 1 mark each. Questions 11 to 15 carry 2 marks each.  
For each question, four options are given. One of them is the correct answer.  
Make your choice (1, 2, 3 or 4). Shade the oval (1, 2, 3 or 4) on the Optical Answer Sheet.  
(20 marks)

1. Three million, nine hundred and eight thousand and five hundred written in numeral is \_\_\_\_\_.
- (1) 398 005
  - (2) 398 500
  - (3) 3 098 500
  - (4) 3 908 500
2.  $6\ 600\ 660 = 6 \times 1\ 000\ 000 + 6 \times \underline{\hspace{2cm}} + (6 \times 100) + 6 \times 10$ .
- (1) 100
  - (2) 1 000
  - (3) 10 000
  - (4) 100 000
3. Arrange the following numbers from the smallest to the largest:
- |    |      |       |       |
|----|------|-------|-------|
| 4, | 3.4, | 3.04, | 3.004 |
|----|------|-------|-------|
- (1) 3.004, 3.04, 3.4, 4
  - (2) 3.4, 3.04, 3.004, 4
  - (3) 4, 3.004, 3.04, 3.4
  - (4) 4, 3.4, 3.04, 3.004
4. Which of the following is **incorrect**?
- (1)  $0.3 = 3\%$
  - (2)  $0.08 = 8\%$
  - (3)  $0.46 = 46\%$
  - (4)  $0.195 = 19.5\%$

5. ABCD is a square and DEFG is a rectangle.  
 ADF is a triangle whereby AF is the base. Identify the height of triangle ADF.

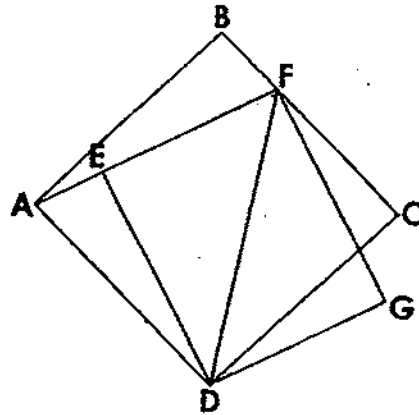

- (1) AB
- (2) AD
- (3) DE
- (4) DF

6. WX and YZ are straight lines.  
 Which of the 2 angles given in the figure are equal?

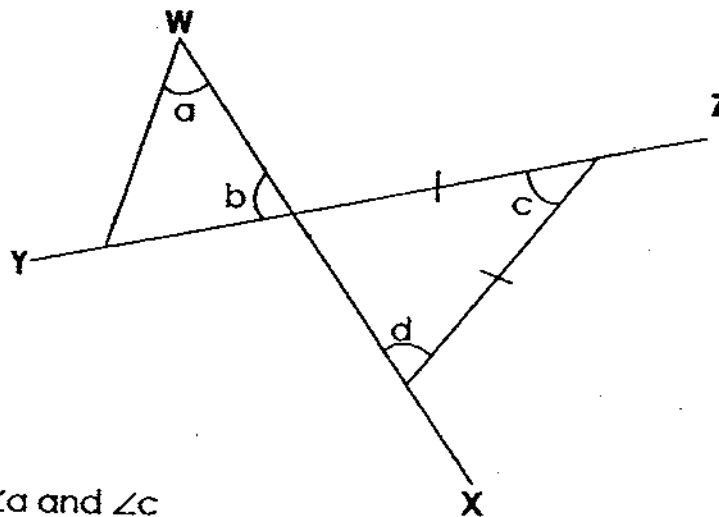

- (1)  $\angle a$  and  $\angle c$
- (2)  $\angle a$  and  $\angle d$
- (3)  $\angle b$  and  $\angle d$
- (4)  $\angle c$  and  $\angle d$

7. The table below shows a baby's mass on the last day of each month from June to September.

Month	Mass (kg)
June	3.2
July	4.9
August	6.1
September	6.8

The average mass of the baby is \_\_\_\_\_.

- (1) 4.2 kg  
 (2) 5.25 kg  
 (3) 7 kg  
 (4) 21 kg
8. The graph below shows the number of people living in different types of housing in Country A.

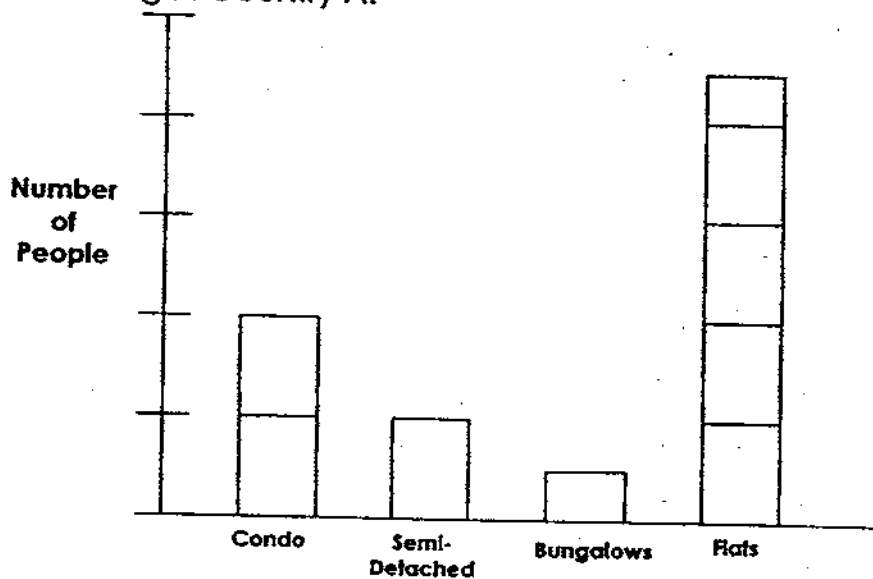

The percentage of people who lives in flats is about \_\_\_\_\_.

- (1) 100%  
 (2) 85%  
 (3) 56%  
 (4) 44%

9 Kelly used 3.6 m of wire to make 8 identical flower brooches.

How many centimetres of wire was used for each brooch?

- (1) 0.45 cm
- (2) 28.8 cm
- (3) 45 cm
- (4) 450 cm

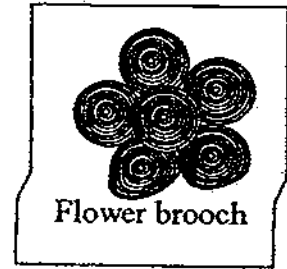

10. STU is a triangle and SWU is a straight line. Find the value of  $x$ .

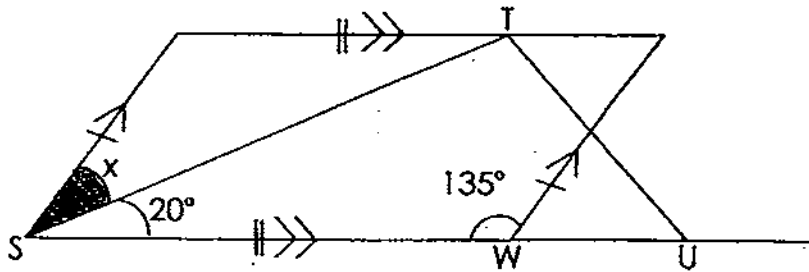

- (1)  $110^\circ$
- (2)  $65^\circ$
- (3)  $45^\circ$
- (4)  $25^\circ$

11. Find the value of ☺.

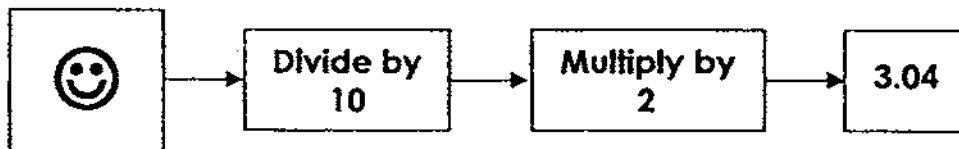

- (1) 0.152
- (2) 0.608
- (3) 15.2
- (4) 60.8

12. The octagon is divided into 4 parts A, B, C and D.  
 The ratio of Area A to Area B to Area C is 5 : 3 : 2.  
 The ratio of Area B to Area D is 1 : 2.  
 Find the ratio of Area C to Area D.

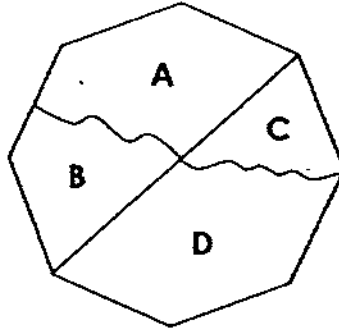

- (1) 1 : 1  
 (2) 1 : 2  
 (3) 1 : 3  
 (4) 1 : 4

13.

$$\boxed{\text{The largest factor of } Z} - \boxed{\text{The smallest factor of } Z} = 34$$

What is Z?

- (1) 15  
 (2) 17  
 (3) 33  
 (4) 35

14.

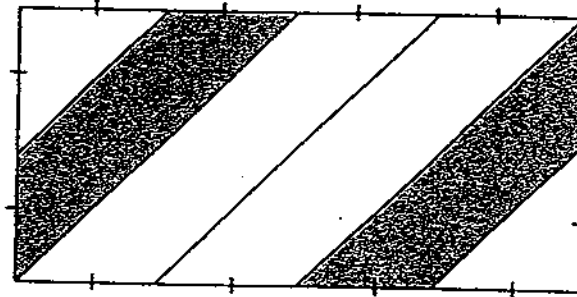

What fraction of the above rectangle is shaded?

- (1)  $\frac{1}{3}$
- (2)  $\frac{3}{5}$
- (3)  $\frac{3}{8}$
- (4)  $\frac{5}{8}$

15.  $\bigcirc$ ,  $\square$ ,  $\nabla$  and  $\star$  represent different numbers.

To obtain the correct total at the end of each row and column, what is the value of  $\bigcirc$  ?

$\star$	$\square$	$\square$	= 13
$\bigcirc$	$\nabla$	$\star$	= 18
$\nabla$	$\star$	$\star$	= 15
= 18	= 17	= 11	

- (1) 6
- (2) 9
- (3) 3
- (4) 5

Name: \_\_\_\_\_ ( )  
class Primary 5 ( )

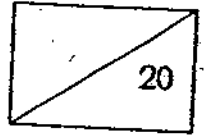

Parent's Signature: \_\_\_\_\_

**MATHEMATICS**  
**PAPER 1**  
**(BOOKLET B)**

**INSTRUCTIONS TO CANDIDATE**

1. Write your name, class and Index No.
2. Do not turn over this page until you are told to do so.
3. Follow all instructions carefully.
4. Answer all questions.
5. Write your answers in this booklet.
6. You are **not** allowed to use a calculator.



Questions 16 to 25 carry 1 mark each. Write your answers in the spaces provided. For questions which require units, give your answers in the units stated. (10 marks)

---

16.  $7\ 430.1 \div 100 =$  \_\_\_\_\_

Ans: \_\_\_\_\_

17. Evaluate  $18 \div (2 \times 3) + 27$ .

Ans: \_\_\_\_\_

18.

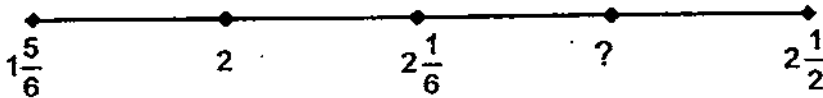

The missing number on the number line is \_\_\_\_\_.

Ans: \_\_\_\_\_

19. Find the area of the shaded region.

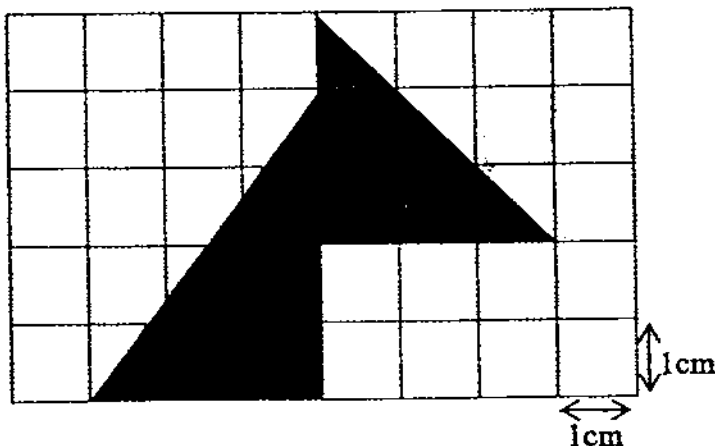

Ans: \_\_\_\_\_ cm<sup>2</sup>

20. How many cubes are needed to form the following solid?

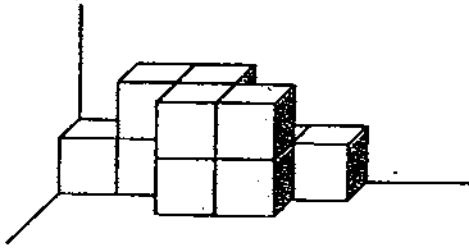

Ans: \_\_\_\_\_

21. In the figure below, ABC is an isosceles triangle. Find the value of  $b$ .

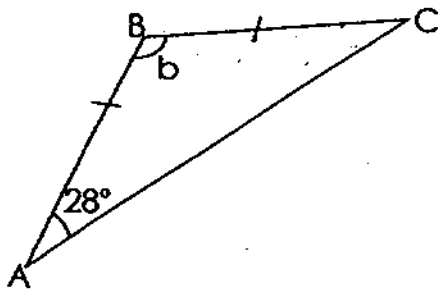

Ans: \_\_\_\_\_°

22. Five countries won an average of 17 medals in the recent Asian Youth Games. Find the number of medals won by Singapore.

Name of Countries	Country 1	Country 2	Country 3	Country 4	Singapore
No. of Medals Won	15	21	11	25	

Ans: \_\_\_\_\_

23. A 7% GST is charged for any purchases made. What is the amount a customer has to pay when buying the following item?



Ans: \$ \_\_\_\_\_

24. Jennifer makes a necklace using 20 black beads and 12 white beads. What fraction of the beads on the necklace is black?

Ans: \_\_\_\_\_

25. Write down the letter which has the dotted line as a line of symmetry.

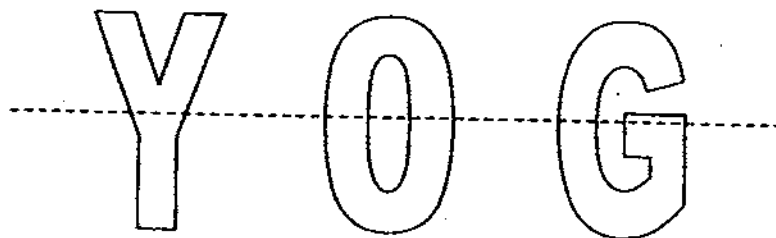

Ans: \_\_\_\_\_

Questions 26 to 30 carry 2 marks each. Show your working clearly in the space provided for each question and write your answers in the spaces provided. For questions which require units, give your answers in the units stated.  
(10 marks)

---

26. Complete the following tessellation in the space provided by adding 4 more unit shapes.

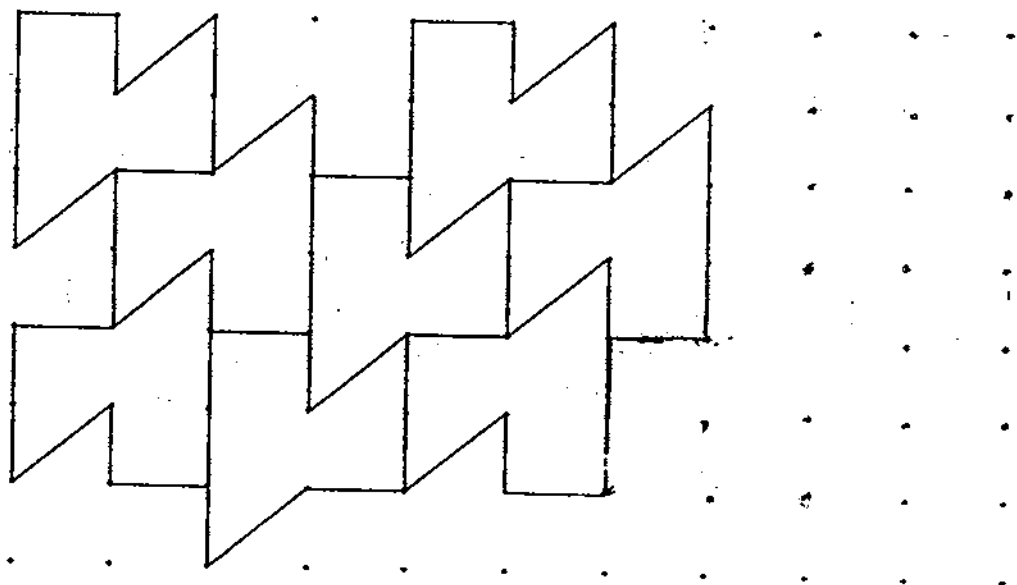

27. In a class, there are 8 more boys than girls. The ratio of the number of girls to the number of boys is 3 : 5. Find the total number of children in the class.

Ans: \_\_\_\_\_

28. A 3-digit number is less than 150. It is divisible by 8 and 9. The number is

\_\_\_\_\_

Ans: \_\_\_\_\_

29. The graph shows the mass of newspapers collected for recycling.

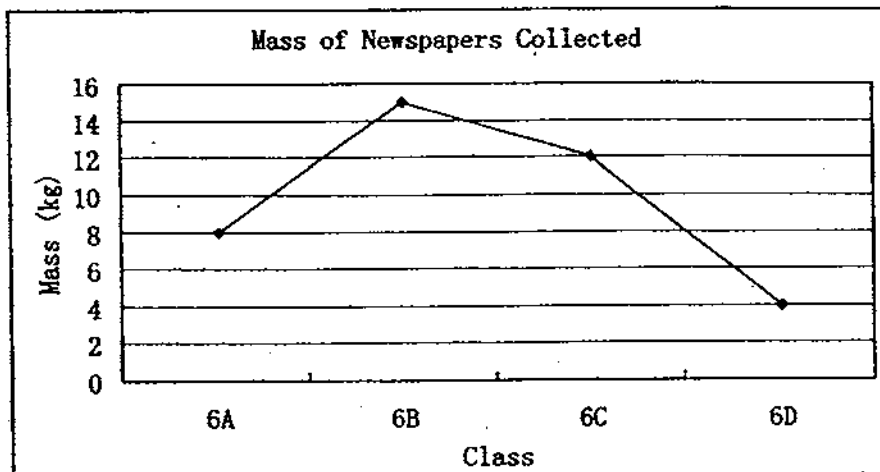

How many grams of newspapers were collected by the four classes?

Ans: \_\_\_\_\_g

30. Find the number represented by the ☆.

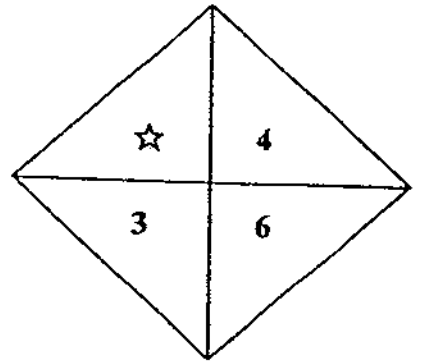
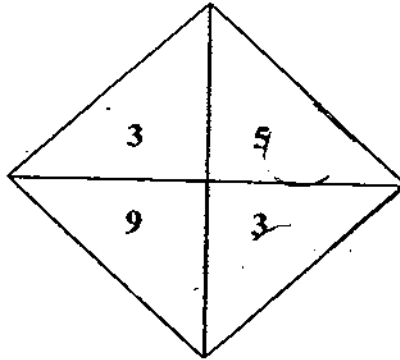
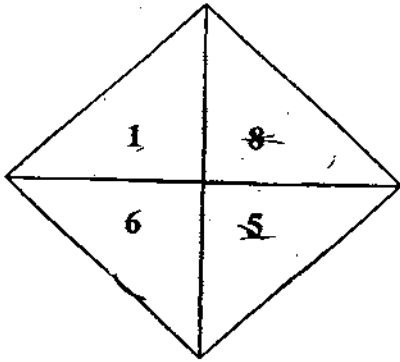

Ans: \_\_\_\_\_

---

END OF PAPER

**Tao Nan School**  
**Primary 5 Mathematics End-of-Year Examination – 2009**

Name: \_\_\_\_\_ (    )    Date : 28 October 2009

Class : Primary 5 (    )    Time : 10.30 a.m. - 12.10 p.m.

Parent's Signature : \_\_\_\_\_    Marks : \_\_\_\_\_ / 60

**MATHEMATICS**

**PAPER 2**

**INSTRUCTIONS TO CANDIDATE**

1. Write your name, class and Index No.
2. Do not turn over this page until you are told to do so.
3. Follow all instructions carefully.
4. Answer all questions.
5. Show your working clearly as marks are awarded for correct working.
6. You are allowed to use a calculator.

Questions 1 to 5 carry 2 marks each. Show your working clearly in the space provided for each question and write your answers in the spaces provided. For questions which require units, give your answers in the units stated.

(10 marks)

1. JK and LM are straight lines. Find the value of  $n$ .

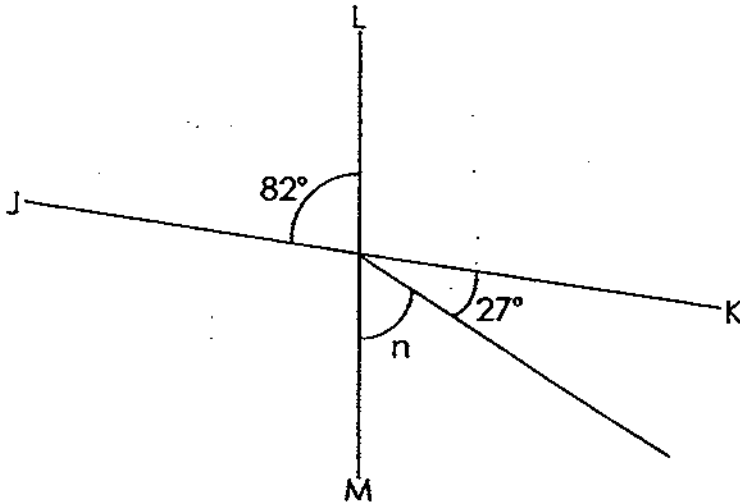

Ans: \_\_\_\_\_°

2. WXYZ is a square. Find the shaded area.

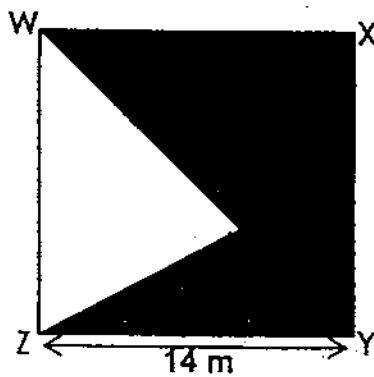

Ans: \_\_\_\_\_ m<sup>2</sup>



3. The bar graph shows the number of family members per family in a housing estate.

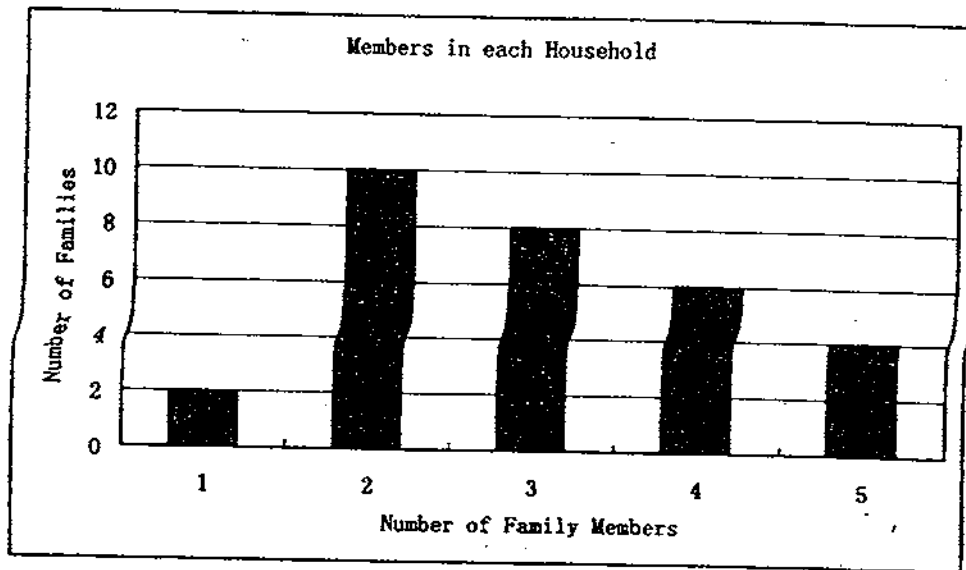

What is the total number of people living in this estate?

Ans: \_\_\_\_\_

4. Using all the following cards with numbers and operators written on them, arrange them to form a number sentence with the answer 1. (You may use brackets ( ) where necessary).



Ans: \_\_\_\_\_

5. The table below shows the number of candidates who took part in a Mathematics Olympiad Competition.

Level	Primary 4	Primary 5	Primary 6
Number of Candidates	35	90	60

The result of the competition is as follows:

60% of the candidates who took part in the competition achieved a bronze award.

Level	Primary 4	Primary 5	Primary 6
Number of Candidates	18	?	38

How many Primary 5 candidates achieved the bronze award?

Ans: \_\_\_\_\_

For questions 6 to 18, show your working clearly in the space provided for each question and write your answers in the spaces provided.  
The number of marks available is shown in brackets [ ] at the end of each question or part-question. (50 marks)

---

6. Mrs Farah bought 1240 g of chicken, 425 g of vegetables and some potatoes to cook a pot of curry. She bought 255 g more potatoes than vegetables. How many kilograms of ingredients did she buy?

Ans: \_\_\_\_\_ [3]

---

7. Lynn has four times as many stickers as her sister. How many stickers must Lynn give to her sister so that each will have 155 stickers?

Ans: \_\_\_\_\_ [3]

---

8.  $\frac{3}{7}$  of Lance's age is equal to  $\frac{1}{6}$  of his mother's age. If Lance's mother is 33 years older than him, how old is Lance?

Ans: \_\_\_\_\_ [3]

---

9. The figure is made up of a parallelogram and a triangle. The ratio of the area of the parallelogram to the area of the triangle is 9 : 4. The shaded part is  $\frac{1}{4}$  of the area of the triangle. Find the ratio of the shaded part of the figure to the unshaded part of the figure.

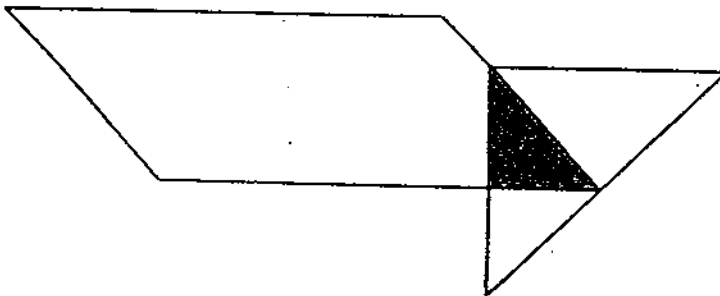

Ans: \_\_\_\_\_ [3]

---

10. Figures A and B are formed by identical rectangles without overlapping. The perimeter of Figure A is 42 cm. Find the area of the unshaded square in Figure B.

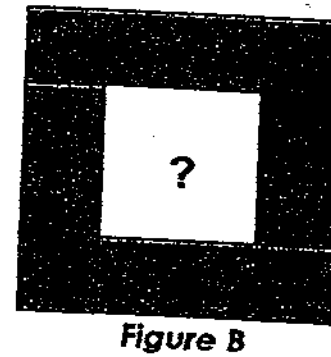
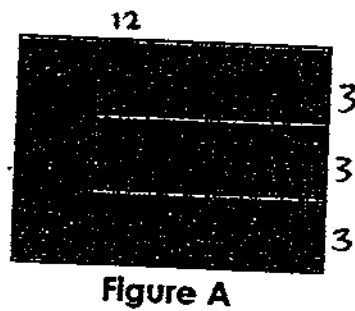

Ans: \_\_\_\_\_ [3]

11. Rose and her three friends went to the bowling alley. The average score of the games played by Rose and one friend is 104. The total score of the games played by the other 2 friends is 368. What is the average score of the games played by all of them?

Ans: \_\_\_\_\_ [3]

12. ABCD is a rhombus. ADE is an equilateral triangle.

Find (a)  $\angle EAB$

(b)  $\angle ABD$

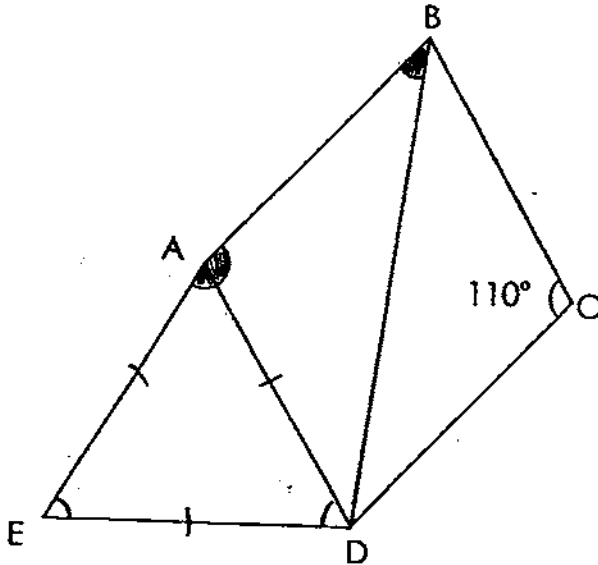

Ans: (a) \_\_\_\_\_ [2]

(b) \_\_\_\_\_ [2]

---

13. Jane wanted to buy a plasma television which was on a 20% discount. The original cost of the television is \$1 588. If she has only \$100-notes, what is the least number of notes that she must bring?

14. The ratio of the number of apples to the number of oranges in a box is 5 : 1. When 10 apples are eaten and 10 oranges are added, there is twice as many apples as oranges.  
How many more apples than oranges are there in the end?

Ans: \_\_\_\_\_ [4]

---

15. Jeff donated  $\frac{1}{10}$  of his money to charity. He spent  $\frac{7}{18}$  of the remaining money on a sports bag and 2 T-shirts and had \$385 left. The sports bag cost thrice as much as a T-shirt.
- (a) How much money did Jeff had at first?
- (b) What was the cost of the bag?

Ans: (a) \_\_\_\_\_ [2]

(b) \_\_\_\_\_ [3]

---



16. Kate has \$50. If she buys 9 files and 22 pens, she will have no money left.  
If she buys 6 files and 12 pens, she will have \$20 left.  
Find the cost of 1 pen.

---

Ans: \_\_\_\_\_ [5]

17. On Monday, there was a total of 930 sweets in Boxes A, B, C and D. On Tuesday, the number of sweets in Box B increased by 10, the number of sweets in Box C decreased by 16 and the number of sweets in Box D was doubled. As a result, there was an equal number of sweets in each box.
- (a) What was the number of sweets in Box D on Tuesday?
- (b) What was the number of sweets in Box C on Monday?

Ans: (a) \_\_\_\_\_ [4]

(b) \_\_\_\_\_ [1]

---

18. Rafi collected 76 more toy cars than Danny. If Danny gives  $\frac{1}{3}$  of his toy cars to Rafi, Rafi will have 4 times as many toy cars as Danny. How many toy cars do they have altogether?

Ans: \_\_\_\_\_ [5]

---

END OF PAPER





# ANSWER SHEET

**EXAM PAPER 2009**

**SCHOOL : TAO NAN PRIMARY**  
**SUBJECT : PRIMARY 5 MATHEMATICS**

**TERM : SA2**

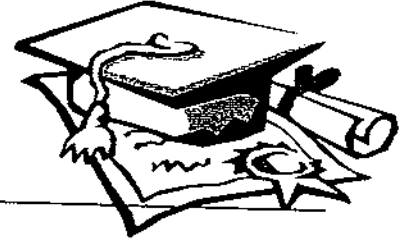

Q1	Q2	Q3	Q4	Q5	Q6	Q7	Q8	Q9	Q10	Q11	Q12	Q13	Q14	Q15
4	4	1	1	3	3	2	3	3	4	3	3	4	3	1

16) 74.301      17) 30      18)  $2\frac{1}{3}$       19)  $10.5\text{cm}^2$       20) 11

21)  $124^\circ$       22) 13      23) \$1070      24)  $\frac{5}{8}$       25) 0

26)      27) 32

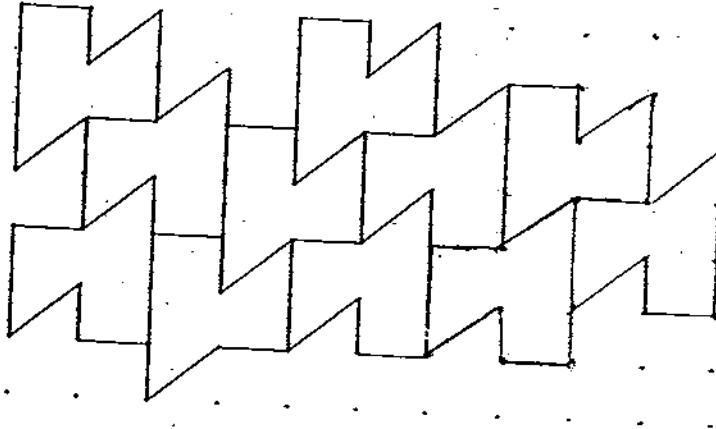

28) 144      29) 39000g      30) 7

paper 2

1) $82^\circ - 27^\circ = 55^\circ$	2) $\frac{1}{2} \times 5 \times 14 = 35$ $\frac{1}{2} \times 14 \times 14 = 98$ $98 + 35 = 133\text{m}^2$
3) $10 \times 2 = 20$ $8 \times 3 = 24$ $6 \times 4 = 24$ $4 \times 5 = 20$ $2 + 20 + 24 + 24 + 20 = 90$	4) $(20 - 16) \div 4 = 1$
5) $35 + 90 + 60 = 185$ $185 / 100 \times 60 = 111$ $111 - 18 - 38 = 55$	6) $425 + 255 = 680$ $680 + 1240 + 425 = 2345$ $2345\text{g} = 2.345\text{kg}$ She bought 2.345kg of ingredients.
7) 5 units $\rightarrow 155$ 1 unit $\rightarrow 155 \div 5 = 31$ 3 units $\rightarrow 31 \times 3 = 93$ Lynn must give 93 stickers to her sister.	8) 11 units $\rightarrow 33$ years 1 unit $\rightarrow 33 \div 11 = 3$ 7 units $\rightarrow 3 \times 7 = 21$ Lance is 21 years old.
9) 1:11	10) $42 \div 14 = 3$ $3 \times 3 = 9$ $9 - 3 = 6$ $6 \times 6 = 36$ The area is $36\text{cm}^2$
11) $104 \times 2 = 208$ $368 + 208 = 576$ $576 \div 4 = 144$ The average score is 144	12) a) $180^\circ \div 3 = 60^\circ$ $60^\circ + 110^\circ = 170^\circ$ $\angle EAB$ is $170^\circ$ b) $180^\circ - 110^\circ = 70^\circ$ $70^\circ \div 2 = 35^\circ$ $\angle ABD$ is $35^\circ$
13) 13	14) 20
15) a) \$700 b) \$147	16) \$1.25
17) a) 264 b) 280	18) 190