



Anglo-Chinese School (Primary)

MID-YEAR EXAMINATION 2011  
SCIENCE  
PRIMARY FIVE  
BOOKLET A

Name: \_\_\_\_\_ ( )

Class: Primary 5 \_\_\_\_\_

Date: 11<sup>th</sup> May 2011

Duration of paper: 1h 45min

\_\_\_\_\_  
Parent's/Guardian's Signature

**INSTRUCTIONS TO CANDIDATES**

1. This question paper consists of 24 printed pages.
2. Do not turn this page until you are told to do so.
3. Follow all instructions carefully.
4. Shade your answer on the Optical Answer Sheet (OAS) provided.

For each question from 1 to 30, four options are given. One of them is the correct answer. Make your choice and shade the correct oval (1, 2, 3 or 4) on the Optical Answer Sheet.

(60 marks)

1 Which one of the following is a characteristic of all insects?

- (1) They have only one pair of wings.
- (2) They give birth to their young alive.
- (3) Their bodies are covered with feathers.
- (4) Their bodies are made up of three parts.

2 Study the classification table below. The animals in the classification table have been grouped according to their method of reproduction.

Group A	Group B
Lion	Frog
Rabbit	Ostrich
Kangaroo	Penguin
Blue Whale	Cockroach
Animal X	Animal Y

Which one of the following pairs of animals should X and Y be?

	Animal X	Animal Y
(1)	Chicken	Guppy
(2)	Hamster	Mosquito
(3)	Ant	Angelfish
(4)	Electric Eel	Python

- 3 The picture below shows the human digestive system. At which part of the system does the digestion of food end?

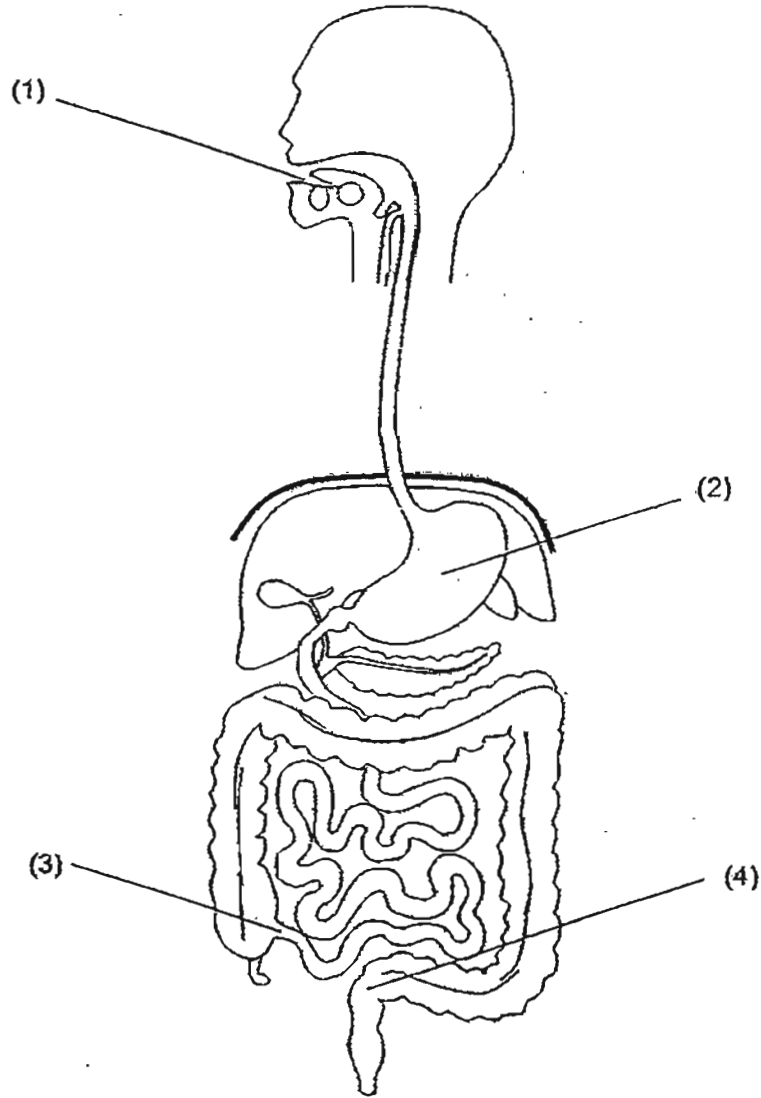

- 4 The picture below shows a potted plant. Some students in a class wrote down the function of the stem.

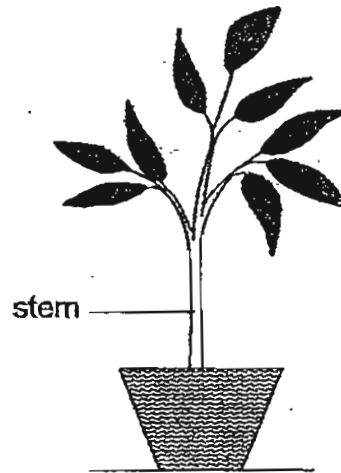

- Arshad: The stem helps the plant to make food.  
Krishnan: The stem helps to hold the plant upright.  
Paul: The stem helps to store food made by the plant.  
Wee Heng: The stem transports water and mineral salts to the leaves.

Based on the diagram only, which of the following student(s) is/are correct?

- (1) ~~Krishnan~~<sup>Paul</sup> only  
(2) Paul and Krishnan  
(3) Arshad and Wee Heng  
(4) Krishnan and Wee Heng

- 5 The line graph below shows the change in population size of organism X over a period of four months. The number of organism X at the beginning was 300.

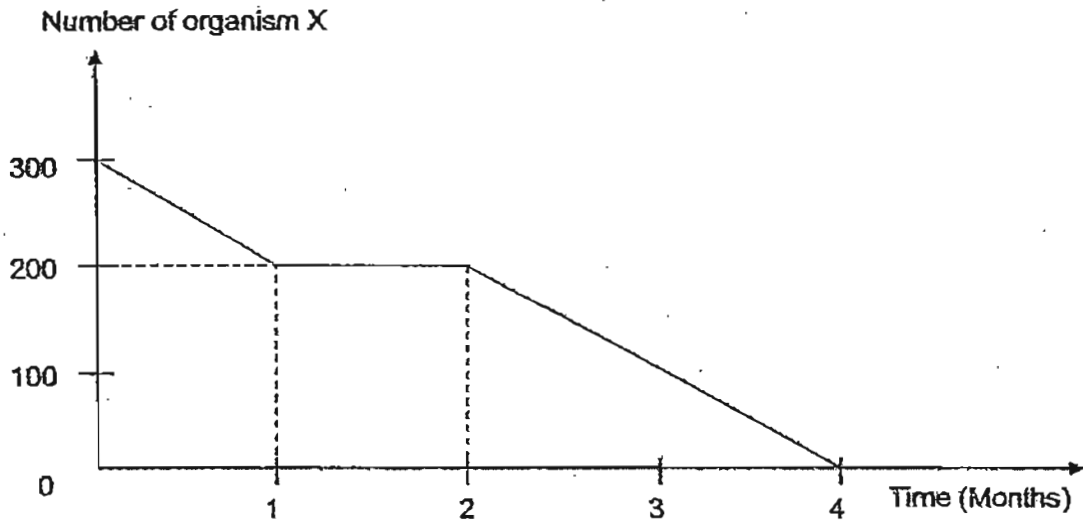

Based on the graph only, which one of the following statement is correct?

- (1) The number of X decreases every month.
- (2) The number of X remained the same for a month.
- (3) The whole population of X died eventually due to a lack of food.
- (4) The highest number of X was recorded at the end of the first month.

- 6 A group of students counted the animals and plants in the school pond. The results were shown in a table below.

Organism	Number
Frog	2
Guppy	3
Tadpole	4
Duckweed Plant	10

Based on the table above only, which of the following statement(s) about the plants and animals in the pond is/are definitely true?

- A There are 9 populations of animals.
  - B There is a pond community represented in this table.
  - C There are at least three populations of plants and animals.
- (1) A only  
(2) C only  
(3) B and C only  
(4) A, B and C

- 7 The diagram below shows what happens when water changes from one state to another.

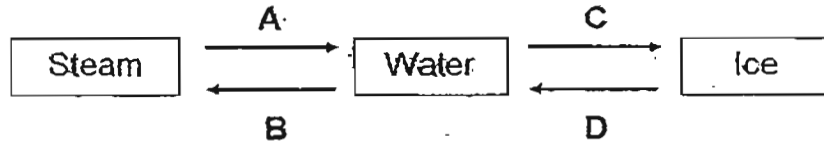

Which one of the following best describes the arrows?

	A	B	C	D
(1)	Lose heat	Gain heat	Lose heat	Gain heat
(2)	Gain heat	Gain heat	Lose heat	Lose heat
(3)	Lose heat	Lose heat	Gain heat	Gain heat
(4)	Gain heat	Lose heat	Gain heat	Lose heat

- 8 Which one of the following statements is not true about the water cycle?
- (1) Water evaporates to form clouds.
  - (2) The water cycle takes place all the time.
  - (3) Water droplets fall from the clouds as rain, snow or hailstones.
  - (4) Condensation is one of the processes taking place in the water cycle.

- 9 Kelvin wanted to investigate if water is needed for the germination of plants. He set up the experiment as shown below.

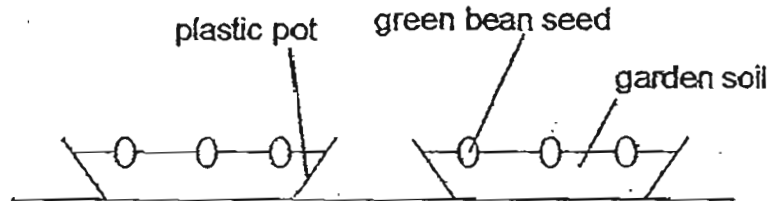

In order to make this experiment a fair one, what are the variables that he must keep constant?

- A Material of pot
  - B Amount of water
  - C Amount of garden soil
  - D Amount of warmth given
- (1) A and B only
- (2) C and D only
- (3) A, C and D only
- (4) B, C and D only



10 The following statements are suggestions on how water can be conserved.

- A Take a quick shower instead of a bath.
- B NEWater is made by purifying waste water.
- C When washing a car, use a pail of water instead of a hose.
- D Collect water used in rinsing clothes for use in washing the toilet.

Classify the suggestions A, B, C and D under the correct heading of recycling, reducing or reusing water.

	Recycling water	Reducing water	Reusing water
(1)	D	A	B
(2)	B	A	D
(3)	B	D	A
(4)	D	C	B

11 The melting and boiling points of 3 substances E, F, G are given in a table below.

Liquid	Melting Point (°C)	Boiling Point (°C)
E	40	100
F	25	78
G	10	85

Which of the substances is/are liquid at 80 °C?

- (1) E only
- (2) F only
- (3) E and G only
- (4) F and G only

- 12 The diagram below shows a glass of water. Joanne wants the water in the glass to dry up as quickly as possible.

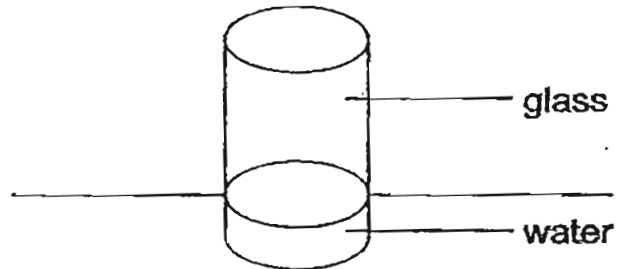

What should she do?

- A She should add salt to the water.
- B She should pour the water into a plate.
- C She should put the glass of water near the fan.
- D She should put the glass of water in a sunny place.

- (1) A and C only
- (2) B and D only
- (3) B, C and D only
- (4) A, B, C and D

- 13 What are the factors that cause a decrease in the population size of an organism?

- A Migration of organism
- B Increased births of organism
- C Increased deaths of organism

- (1) A only
- (2) B only
- (3) A and C only
- (4) A, B, and C

- 14 Which one of the following graphs shows the correct temperature change when tap water is heated until it boiled?

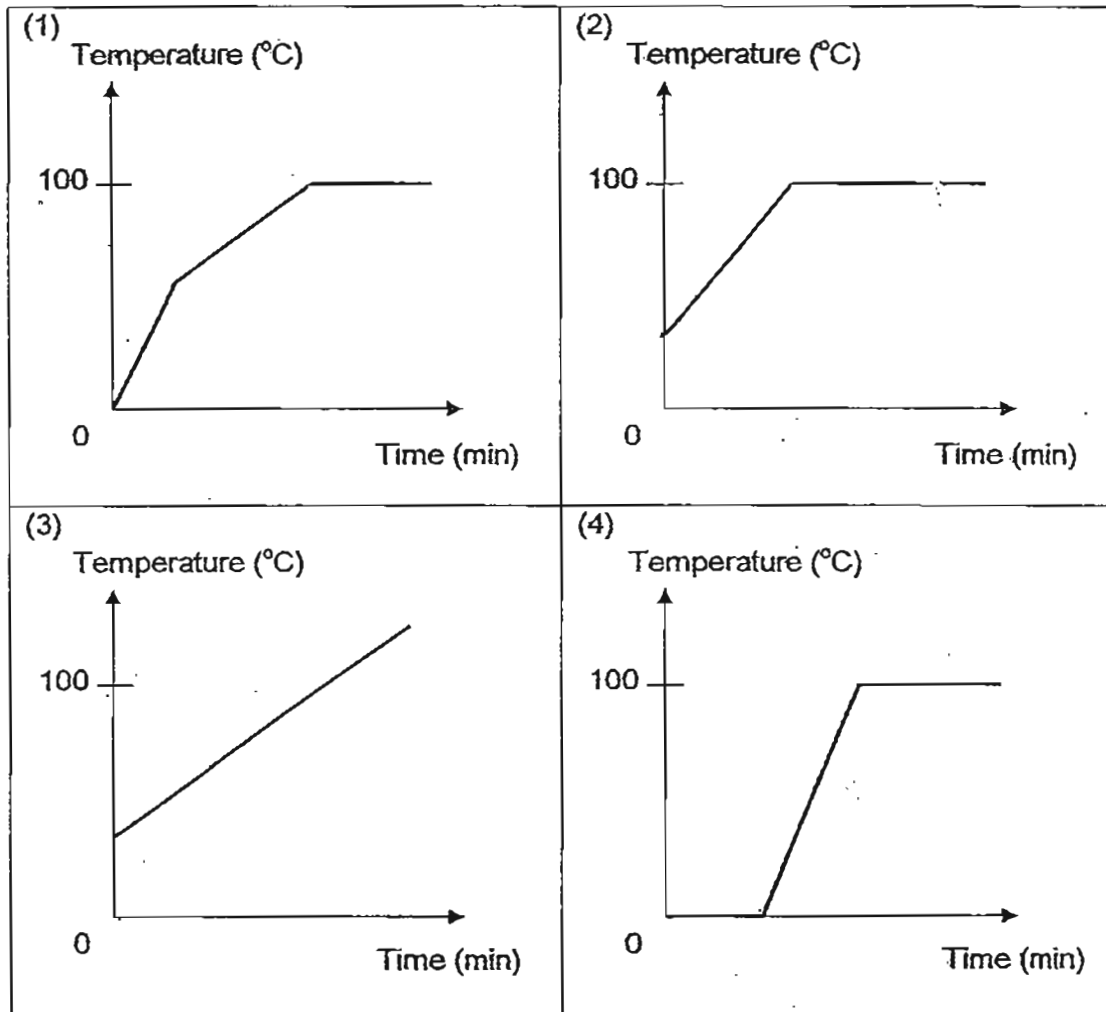

- 15 Early in the morning, Ryan observed that there were water droplets on the outside of cars, even though it did not rain the night before.

What is the correct explanation for Ryan's observation?

- (1) Water vapour on the cool car condensed into the air.
- (2) Water vapour from the air condensed on the cool car.
- (3) Water droplets on the warm car evaporated to the air.
- (4) Water droplets from the warm air evaporated on the car.

16 Which one of the following best represents the life cycle of a plant?

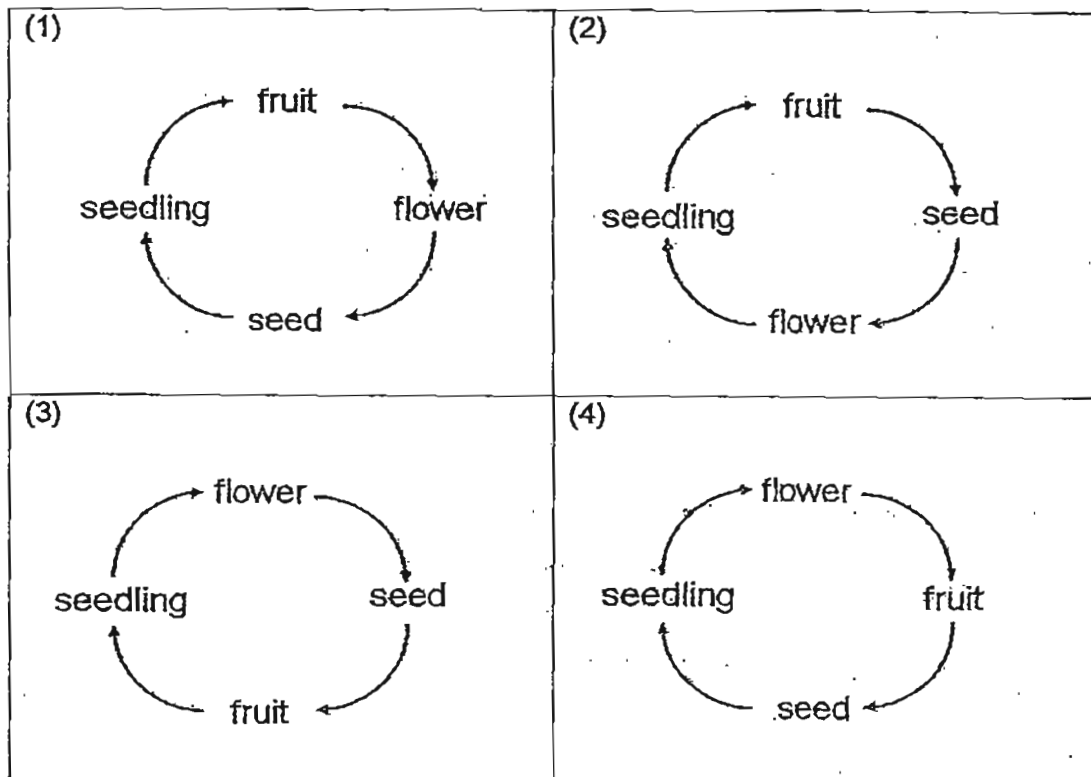

17 Kenny conducted an experiment by following these procedures.

- Step 1: Pour 500 ml of water into a measuring cylinder
- Step 2: Put a ball of plasticine into the measuring cylinder and measure the new water level.
- Step 3: Carefully remove the plasticine from the measuring cylinder and flatten it
- Step 4: Put the flattened plasticine back into the measuring cylinder.
- Step 5: Measure and record the water level.

Which one of the following statements is the most likely aim of Kenny's experiment?

- (1) To find out whether the shape of the plasticine affect its mass.
- (2) To find out whether the shape of the plasticine affect its volume.
- (3) To find out whether the volume of the plasticine affect the volume of the water.
- (4) To find out whether the volume of the water affect the volume of the plasticine.

- 18 The bar graph below shows the number of days that each stage of the life cycles of insects X and Y lasts.

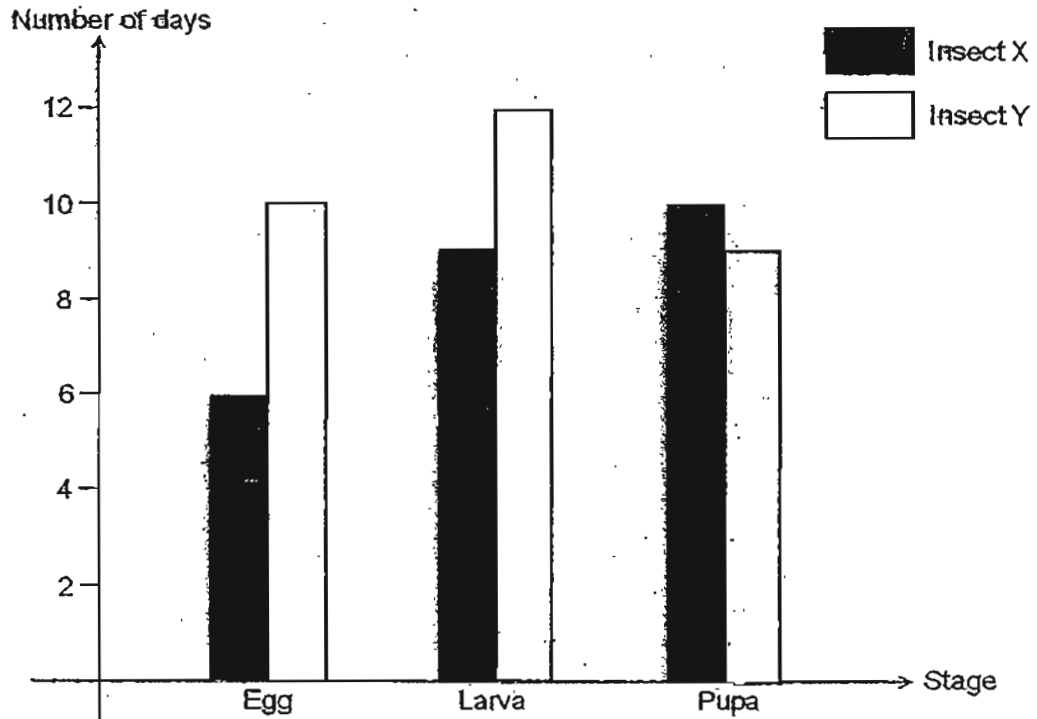

At which stage would insects X and Y be on the 16<sup>th</sup> day after the eggs were laid?

	Insect X	Insect Y
(1)	Pupa	Pupa
(2)	Pupa	Larva
(3)	Larva	Pupa
(4)	Larva	Larva

- 19 Calvin set up an experiment as shown below. He placed some objects inside the box and then removed the top of the cardboard box. He then covered the top of the box with a thin sheet of aluminium.

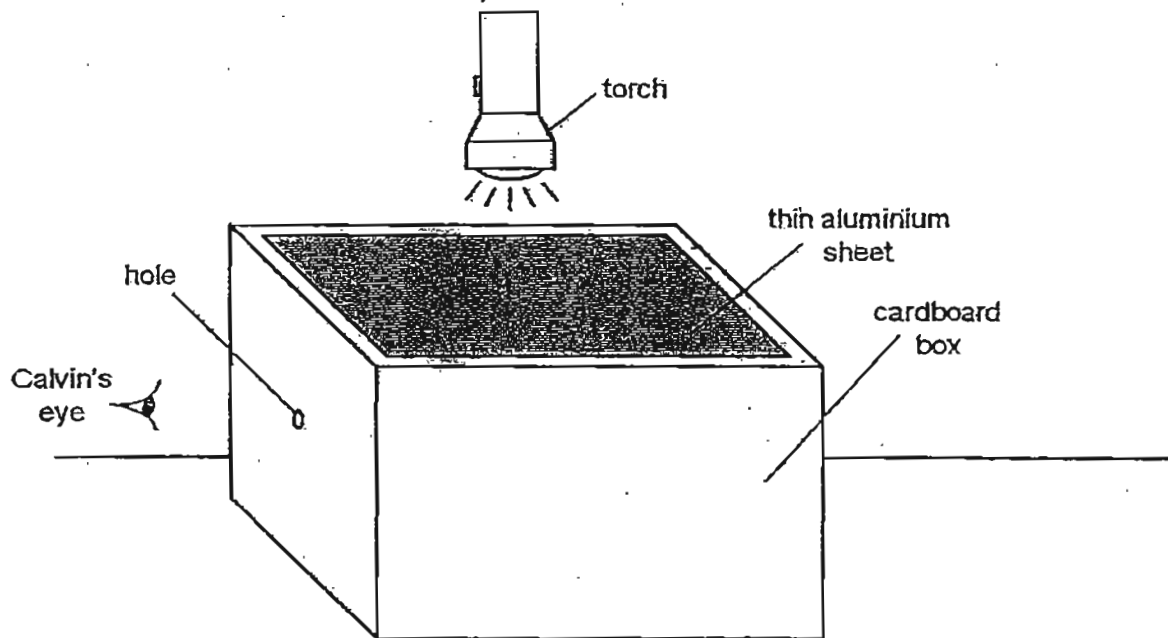

He then switched on the torch and tried to look at the objects in the box through the hole on the side of the box. However, he could not see the objects. What should Calvin do in order for him to see the objects in the box?

- (1) Use a brighter torch.
- (2) Make the hole smaller.
- (3) Replace the aluminium sheet with a mirror.
- (4) Replace the aluminium sheet with a clear plastic sheet.

20 Zachary filled three glass containers of water as shown below.

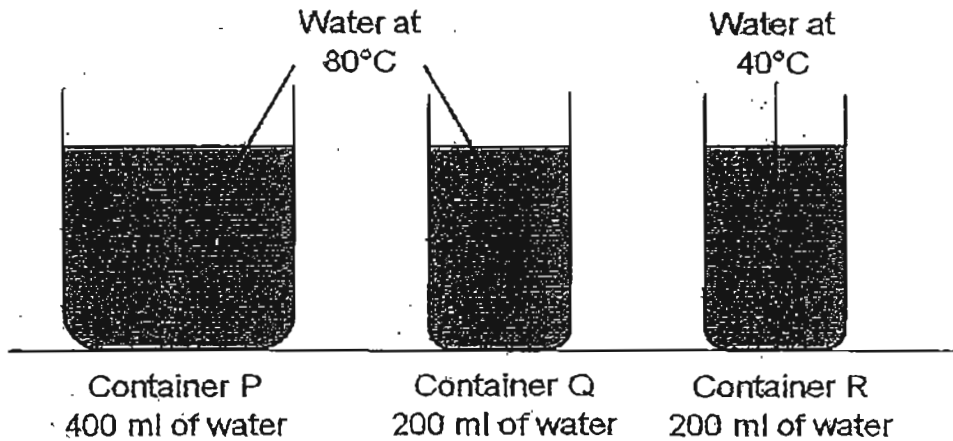

What can Zachary say about the water in the glass containers?

- A The water in containers P and Q has the same amount of heat.
  - B The water in containers Q and R has the same amount of heat.
  - C The water in container P has less heat than the water in container Q.
  - D The water in container P has more heat than the water in container Q.
- (1) A only  
(2) D only  
(3) A and B only  
(4) B and C only

- 21 Matthew hung four metal bars of the same mass, A, B, C and D, from a pole and they moved in different directions as shown in the diagram below.

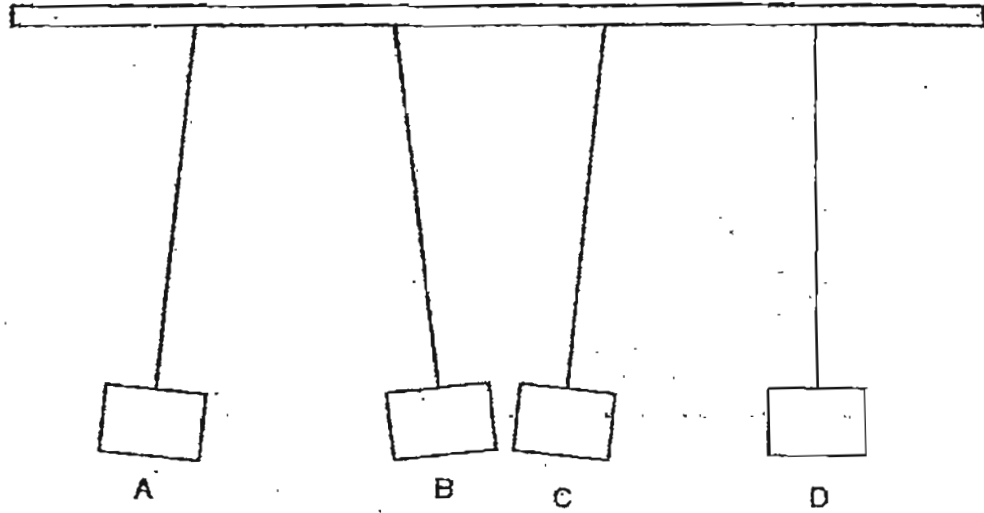

Which two metal bars are most likely to be magnets?

- (1) A and B only
- (2) B and C only
- (3) B and D only
- (4) C and D only



22 Three rod magnets and a steel rod are attracted to each other as shown below.



Which one of the following shows the correct possible arrangement of the poles of the rod magnets and how the steel rod could be arranged?

(1)	
(2)	
(3)	
(4)	

- 23 Timmy wanted to find out whether the number of coils of wire affects the magnetic strength of an electromagnet.

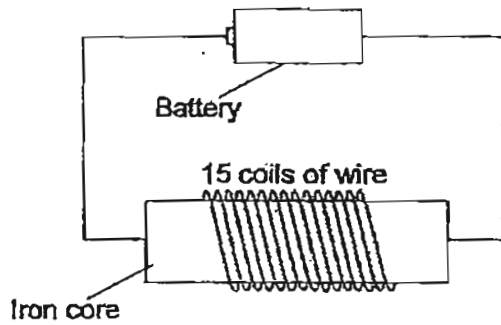

Set-up A

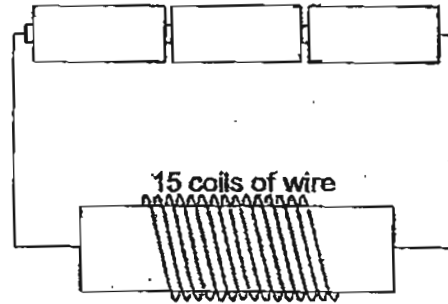

Set-up B

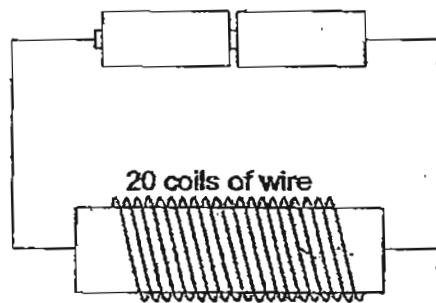

Set-up C

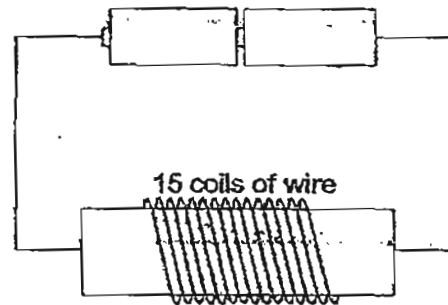

Set-up D

Which two set-ups should Timmy use so that he can conduct a fair test?

- (1) A and B only
- (2) B and C only
- (3) B and D only
- (4) C and D only

24 Samuel conducted an experiment by setting up the circuit as shown below.

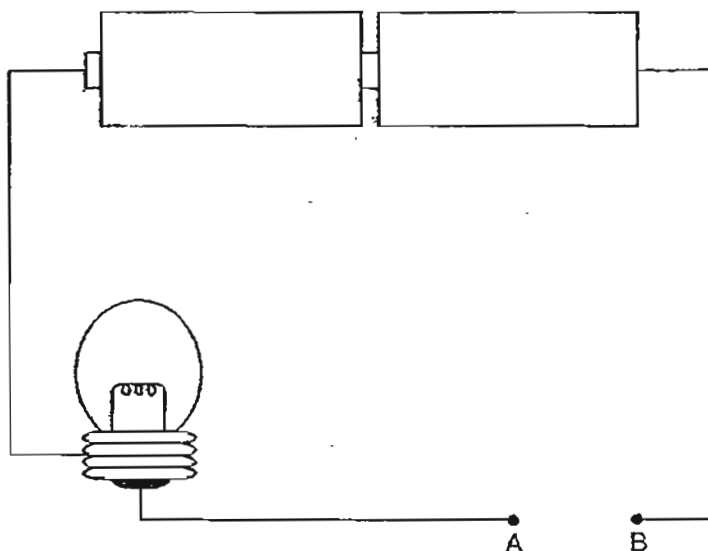

He connected points A and B with a copper rod and observed the brightness of the bulb. He then replaced the copper rod with a longer copper rod and observed the brightness of the bulb again. Samuel repeated the experiment two more times, using longer copper rods each time.

Which one of the following sentences is most likely the aim of Samuel's experiment?

- (1) To find out whether the size of the copper rod affects the brightness of the bulb in the circuit.
- (2) To find out whether the length of the copper rod affects the brightness of the bulb in the circuit.
- (3) To find out whether the copper rod is a good conductor of electricity or an insulator of electricity.
- (4) To find out whether the brightness of the bulb in a circuit is dependent on the presence of a copper rod.

25 Study the diagram below carefully.

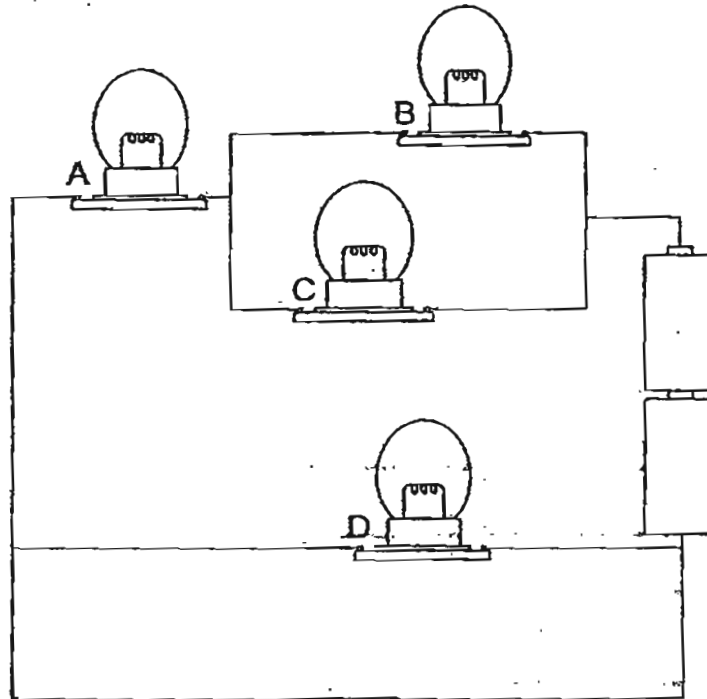

When one of the four bulbs fused, none of the other bulbs would light up. Which bulb had fused?

- (1) A
- (2) B
- (3) C
- (4) D

26 Study the diagram below.

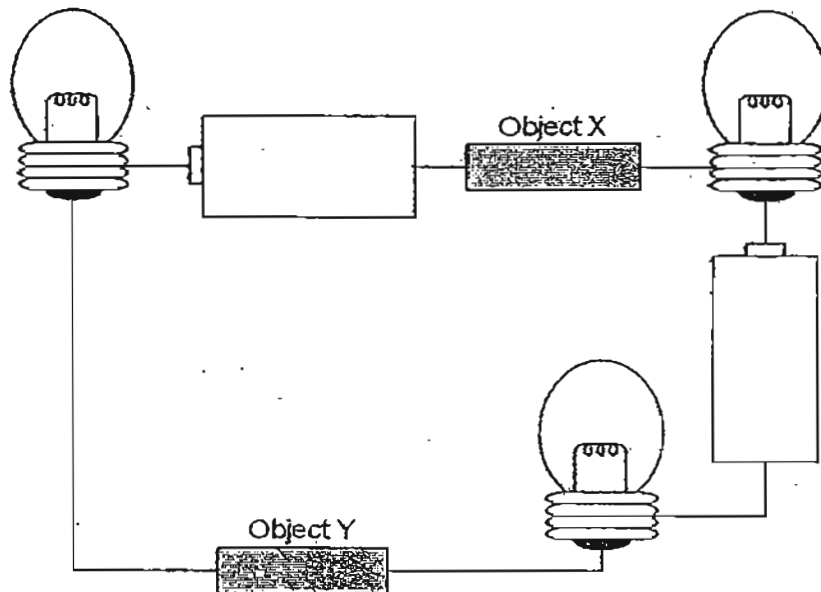

If the three bulbs in the circuit above all light up, what can objects X and Y be?

	Object X	Object Y
(1)	Aluminium foil	Coin
(2)	Charcoal	Tracing paper
(3)	Needle	Eraser
(4)	Toothpick	Glass rod

- 27 The diagram below shows four circuits with different arrangement of identical batteries and identical bulbs. The bulbs in all four circuits light up.

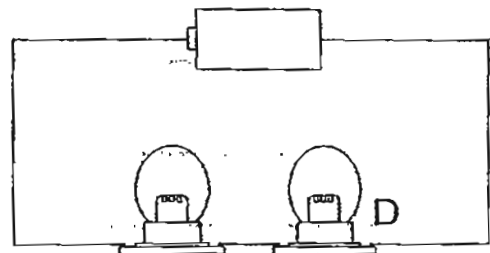
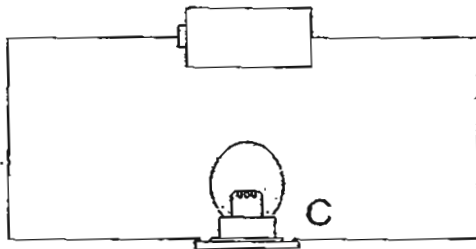
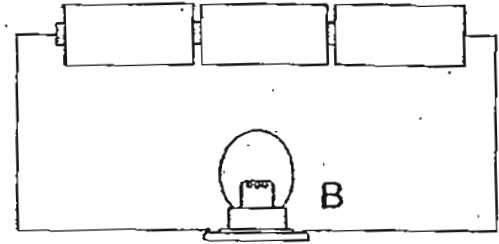
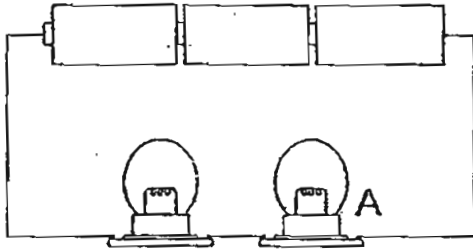

Arrange, in ascending order, the brightness of the bulbs, A, B, C and D.

- (1) A, B, C, D
- (2) B, A, D, C
- (3) C, B, A, D
- (4) D, C, A, B

- 28 The circuit card shown below has a metallic thumbtack at each of the points A, B, C, D and E. Some of the thumbtacks are connected by wires behind the card. The two ends of the circuit tester are connected to two different thumbtacks each time and the results are tabulated as shown below.

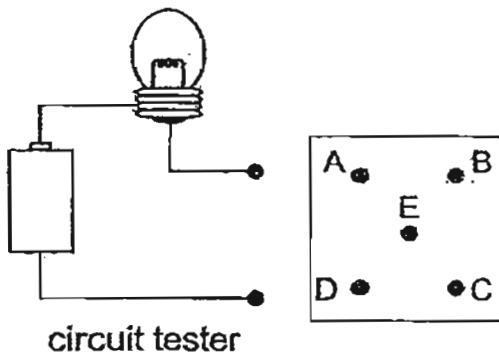

Circuit Tester Connected to	Bulb lights up?
A and B	No
B and C	No
C and D	Yes
D and E	Yes
E and C	Yes

Which one of the following is a possible arrangement of the wires behind the circuit card?

(1)

(2)

(3)

(4)

29 Study the diagram below carefully.

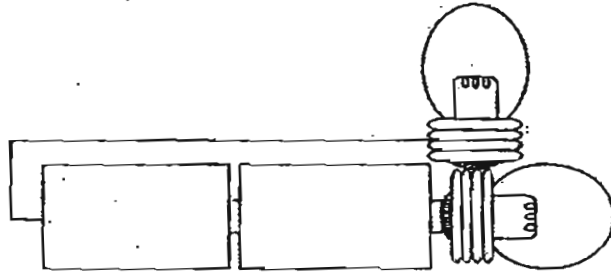

The batteries and light bulbs in the circuit shown above are in good working conditions. However, the light bulbs did not light up.

Which one of the following statements is a possible explanation for the above observation?

- (1) The bulbs were arranged wrongly.
- (2) There was no switch to connect the circuit.
- (3) The number of wires used was not enough.
- (4) The number of batteries used was not enough to light up the bulbs.

30 Which of the following sentences describes how electricity or electrical appliances can be used safely?

- A Never touch switches with wet hands.
- B It is not safe to overload plugs onto a single socket.
- C Electrical appliances with exposed wires can still be used safely.
- D When electrical appliances are faulty, try to repair them yourself.

- (1) A and B only
- (2) B and C only
- (3) A and D only
- (4) A, B and D only.

**END OF BOOKLET A**





Anglo-Chinese School (Primary)

MID-YEAR EXAMINATION 2011  
SCIENCE  
PRIMARY FIVE  
BOOKLET B

Name: \_\_\_\_\_ ( )

Class: Primary 5 \_\_\_\_\_

Date: 11<sup>th</sup> May 2011

Duration of paper: 1h 45min

\_\_\_\_\_  
Parent's/Guardian's Signature

**INSTRUCTIONS TO CANDIDATES**

1. This question paper consists of 14 printed pages.
2. Do not turn this page until you are told to do so.
3. Follow all instructions carefully.

BOOKLET	MAXIMUM MARKS	MARKS OBTAINED
A	60	
B	40	
Total	100	

For questions 31 to 44, write your answers in the spaces provided.

The number of marks available is shown in brackets [ ] at the end of each question or part question:

(40 marks)

31 Study the following flow chart that describes some animals.

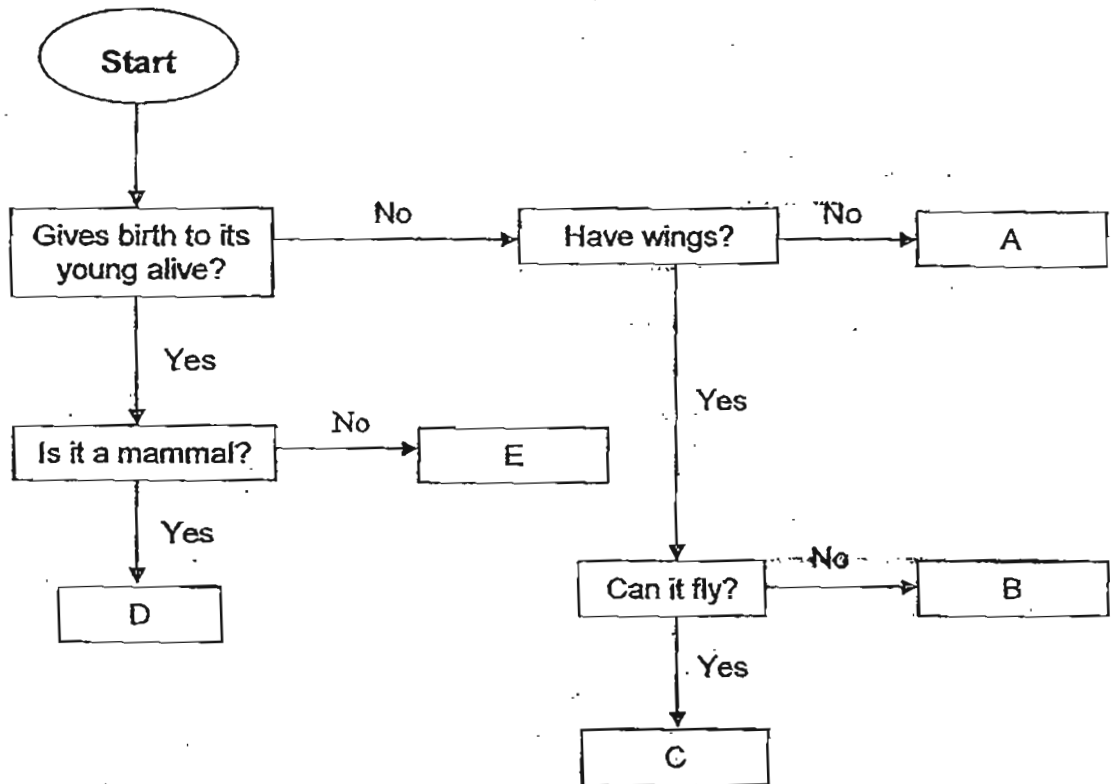

(a) Based on the flow chart, give an example of animal-B. [1]

(b) Based on the flow chart, state all the characteristics of animal-C. [2]

(Go to the next page)

Score	3
-------	---

32 The diagram below shows part of the human digestive system.

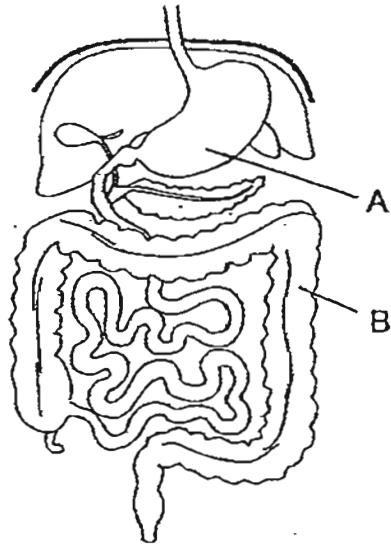

Identify the organs labelled A and B above and describe its functions. [3]

(a) A: \_\_\_\_\_

Function of A: \_\_\_\_\_  
\_\_\_\_\_

(b) B: \_\_\_\_\_

Function of B: \_\_\_\_\_  
\_\_\_\_\_

(Go to the next page)

Score	3
-------	---

- 33 Mirza conducted an experiment using the set-ups as shown below. He filled three identical containers K, L and M with different amounts of water. Next, he placed the containers in a humid place.

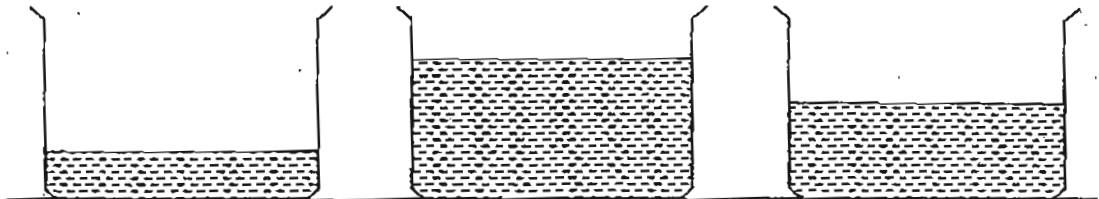

Container K  
100 ml of water

Container L  
300 ml of water

Container M  
200 ml of water

After two hours, he measured the amount of water left in the three containers using a measuring cylinder.

Based on his observations, he wrote three statements. Indicate whether each of the statement is true, false or not possible to tell by putting a tick (✓) in the correct box. [3]

Statements	True	False	Not possible to tell
There is more water left in container L than in container M after 2 hours.			
There is no more water left in container K.			
The water in container M evaporates the slowest.			

(Go to the next page)

Score	3
-------	---

34 The table below shows the conditions of two rivers.

River X	River Y
Water is clear	Water is cloudy
No oil on the surface of water	Oil on the surface of water
Many fishes and water plants living in the water	Few fishes and water plants living in the water

(a) State one evidence which tells us that river X is not polluted. [1]

---

(b) Other than the conditions stated in the table, state two other causes of water pollution in rivers. [2]

---

---

(Go to the next page)

Score	3
-------	---

35 Evaporation and boiling are two processes where water changes from one state to another. State a similarity and a difference between these two processes.

(a) Similarity: [1]

---

---

(b) Difference: [1]

---

---

(c) Besides evaporation of water from water bodies, state one source of water vapour on Earth that contributes to the water cycle. [1]

---

---

36 Harold had a swim in the pool yesterday afternoon. As he walked out of the pool, he felt very cold and had to put a towel over himself, even though it was a hot day.

(a) Why did he feel cold as he walked out of the swimming pool? [2]

---

---

(b) How does the towel prevent himself from being in the cold? [1]

---

---

(Go to the next page)

Score	
-------	---

- 37 A group of students counted the number of plants and animals in their school garden. Three months later, they counted the number of organisms in the same garden, and the results were shown in the bar graph below.

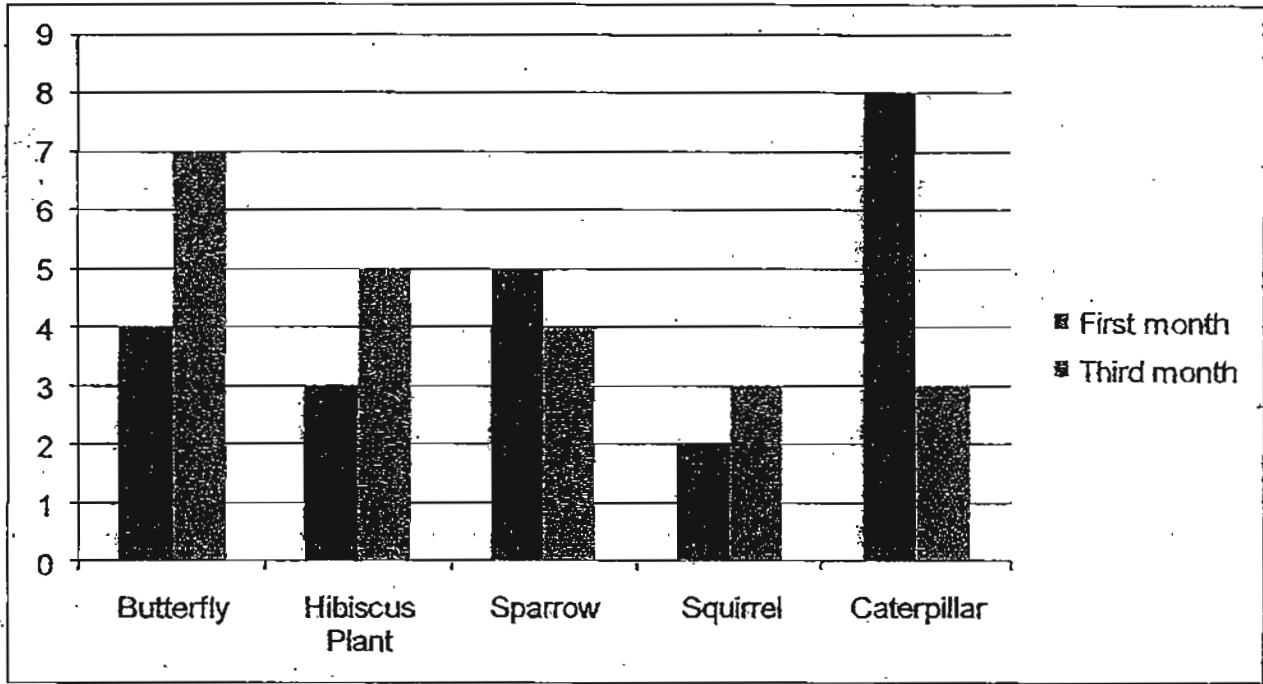

- (a) There was a decrease on the number of caterpillars after three months. Based on the data given in the graph only, state one possible reason for the decline. [1]

- (b) Describe the interdependence between the butterfly and the hibiscus plant in the garden community. [2]

(Go to the next page)

Score	3
-------	---

38 Mandy set up the following experiment as shown below.

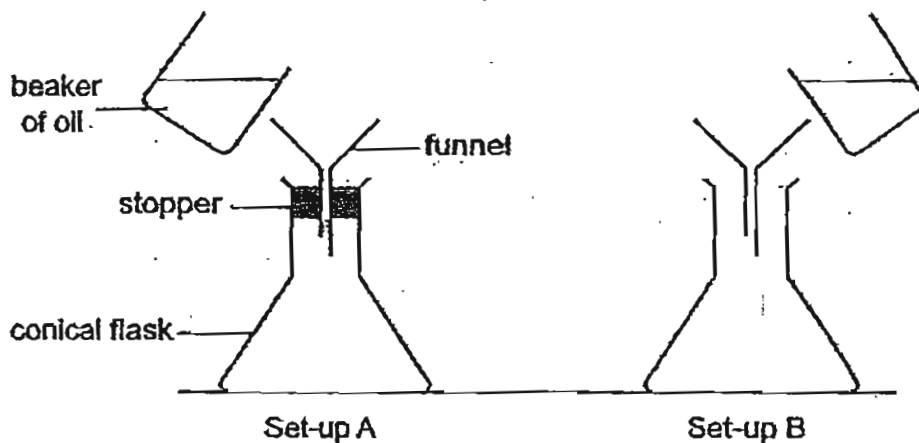

She emptied all the oil in both beakers into the respective funnels and found out that more oil is able to flow into the conical flask in set-up B than set-up A. Explain why. [2]

---

---

---

(Go to the next page)

Score	2
-------	---



- 39 Peter wanted to find out how the amount of light reflected by three different materials, P, Q and R, is affected by the distance the material is away from the light source. He set up his experiment as shown below.

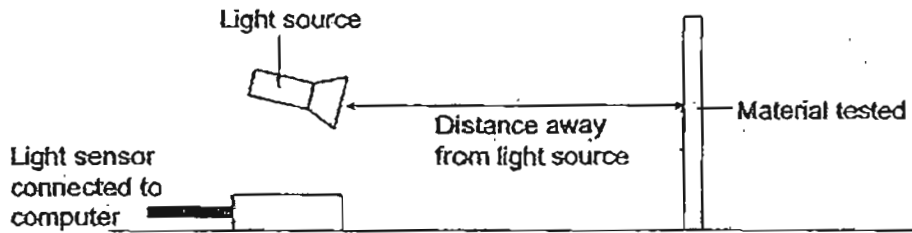

He placed the materials at different distances away from the light source and used the light sensor to measure the amount of light that was reflected. He recorded the results and plotted a graph as shown below.

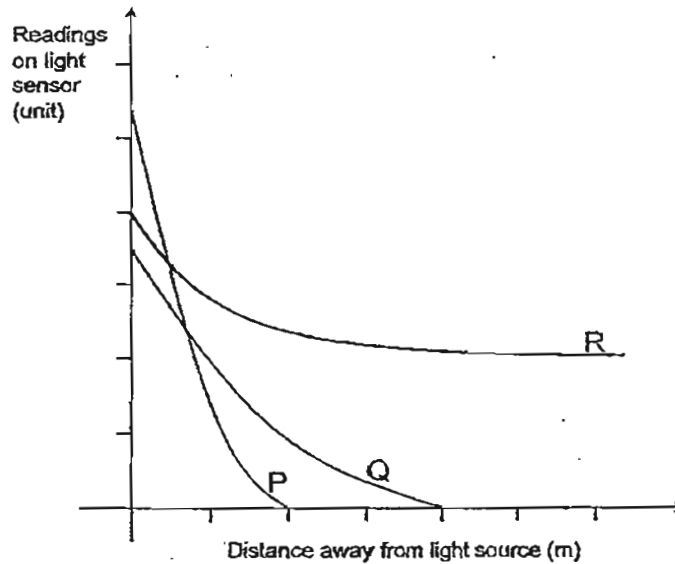

- (a) Explain why Peter should conduct the above experiment in a completely dark room. [2]

---



---

- (b) Based on the results of Peter's experiment, which material would be most suitable for making safety vests for motorists who travel at night? Explain your answer. [2]

---



---

(Go to the next page)

Score	4
-------	---

40 The diagram below shows a two-piece device consisting of parts A and B which is designed for cleaning both sides of a glass window at the same time.

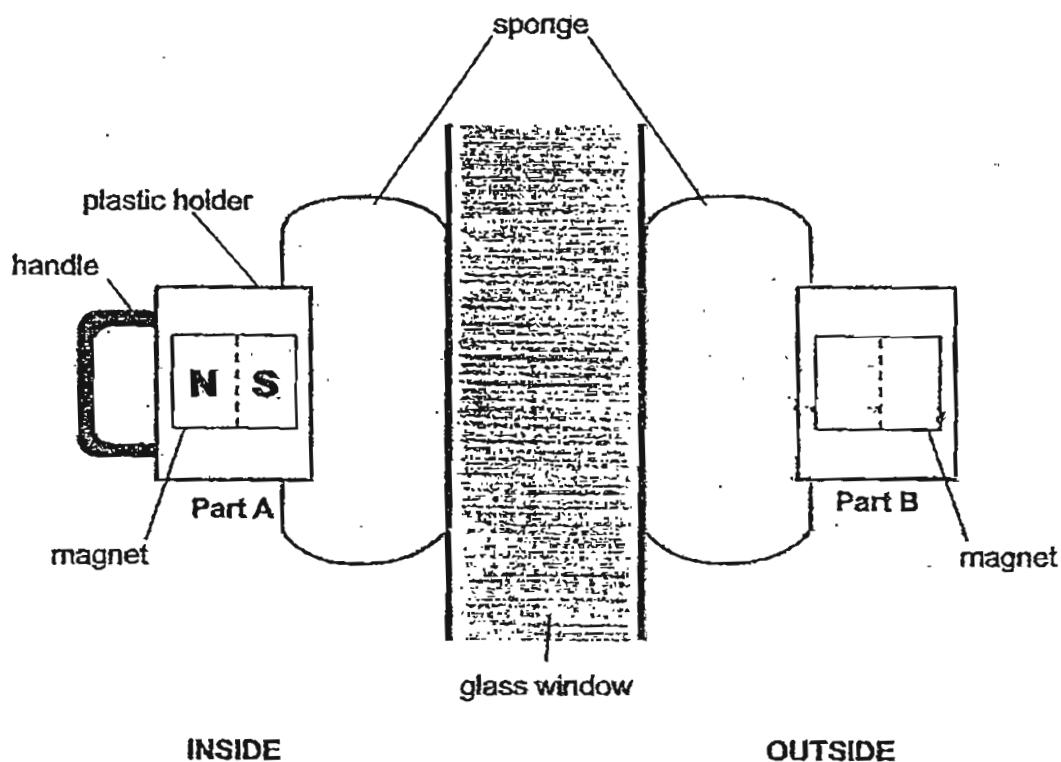

When Part A moves across the inside surface, Part B follows it across the outside surface.

- (a) If the poles of the magnet in Part A are as shown in the diagram, write down, in the diagram above, the poles of the magnet in Part B. [1]
- (b) State another property of magnets, which allows the device to work as described above. [1]

---



---

(Go to the next page)

Score	2
-------	---

41 Kenneth was given two boxes A and B, each containing various items as listed below.

Box A	Box B
Items given: <ul style="list-style-type: none"><li>• Two dry cells</li><li>• One bulb</li><li>• Some wires</li><li>• One switch</li></ul>	Items given: <ul style="list-style-type: none"><li>• Two dry cells</li><li>• Two bulbs</li><li>• Some wires</li><li>• One switch</li></ul>

Kenneth was told by the teacher to use all the items in each of the box to construct two different circuits so that the **bulbs in both circuits fit up and were equally bright**.

Using a pencil and ruler, draw the two possible circuit diagrams Kenneth should form in the boxes below. [4]

Box A

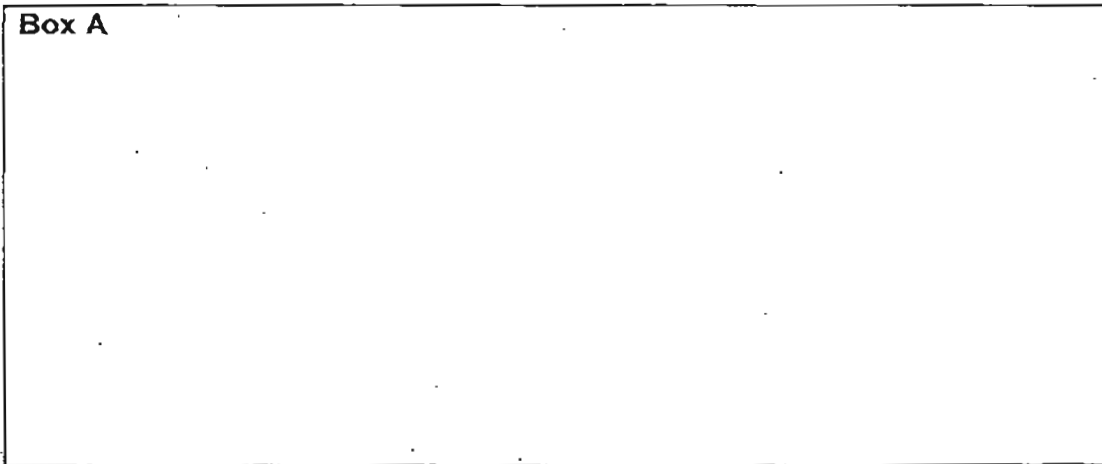

Box B

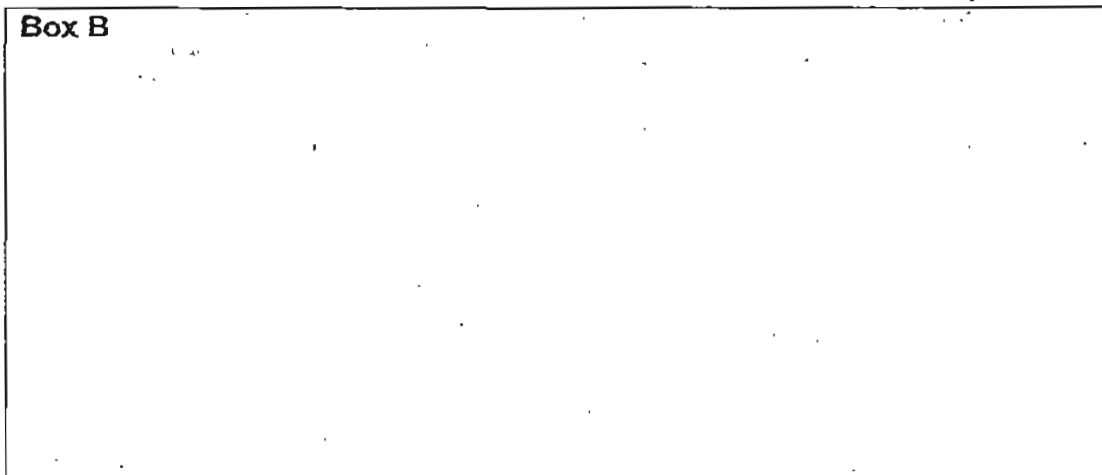

(Go to the next page)

Score	4
-------	---

- 42 Adrian set up 3 similar circuits using identical bulbs, batteries and objects X, Y and Z. The objects are of the same size but made of different materials.

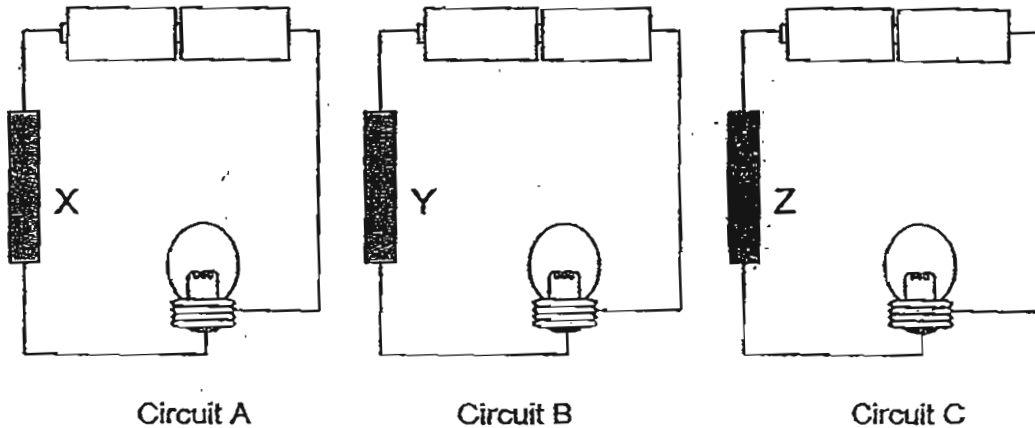

He made the following observations.

- Circuit A:            Bulb did not light up.  
 Circuit B:            Bulb lighted up dimly.  
 Circuit C:            Bulb lighted up brightly.

Based only on the observations made by Adrian, which of the following statement(s) is/are true, false or not possible to tell? Put a tick (✓) in the correct box below. [3]

Statements	True	False	Not possible to tell
X is a good conductor of heat.			
Y is a conductor of electricity.			
Z is a magnetic material.			

(Go to the next page)

Score	3
-------	---

- 43 The diagram below shows a simplified circuit for an electric bell. The aluminium screw is just touching the iron rod when the switch is opened.

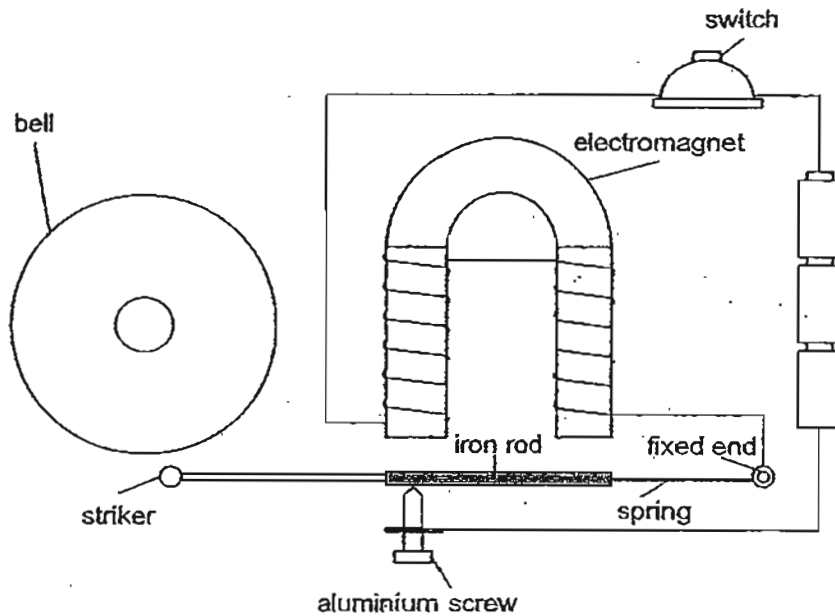

When the switch is closed, the striker hits the bell and returns to its original position. Explain how this happens. [2]

---

---

---

---

(Go to the next page)

Score	2
-------	---

44 Study the picture below carefully.

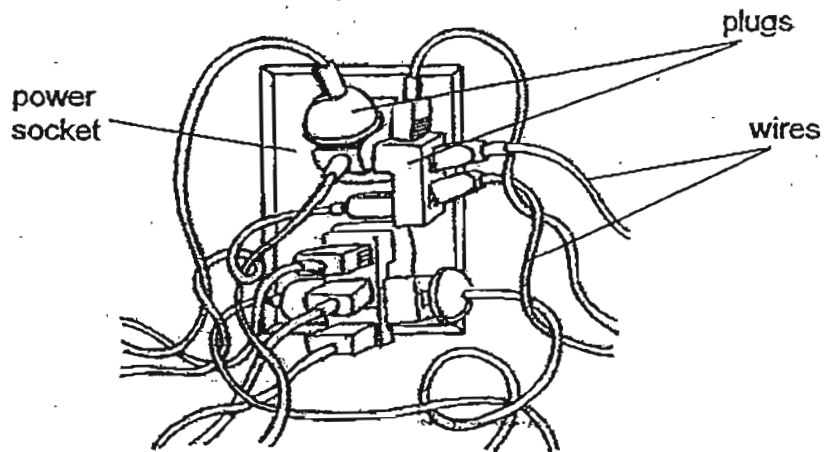

(a) Explain why overloading at the power socket is dangerous. [1]

---

---

(b) The wires of the electrical appliances are covered with rubber as shown in the picture above. Explain how this allows a person to use the electrical appliances safely. [1]

---

---

Score	2
-------	---

END OF BOOKLET B

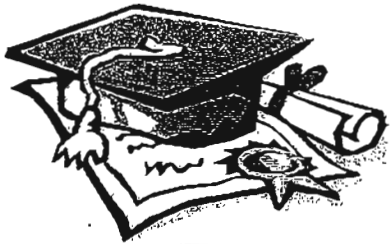

# ANSWER SHEET

**EXAM PAPER 2011**

**SCHOOL : ACS  
SUBJECT : PRIMARY 5 SCIENCE**

**TERM : SA1**

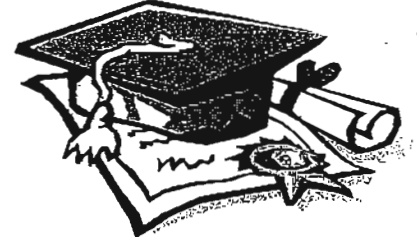

Q1	Q2	Q3	Q4	Q5	Q6	Q7	Q8	Q9	Q10	Q11	Q12	Q13	Q14	Q15	Q16	Q17
4	2	3	4	2	3	1	1	3	2	3	3	3	2	2	4	2

Q18	Q19	Q20	Q21	Q22	Q23	Q24	Q25	Q26	Q27	Q28	Q29	Q30
2	4	2	1	2	4	2	1	1	4	2	4	1

31)a)Emu.

b)Animal C cannot give birth to its young alive but it has wings and it can fly.

32)a)A: Stomach

Function of A: To break down the food into smaller substances.

b)B: large intestine

Function B: To absorb water from the undigested food.

33)T, Not, F

34)a)There is no oil on the surface of water.

b)Litter and chemical wastes seen at the river and deforestation near the river.

35)a)Both processes change the state of water from liquid to gas.

b)Boiling is much more faster than evaporation when both take place at the same time.

c)Transpiration from plants.

36)a)As Harold came out of the pool, water on his body began to evaporate, As heat from his body is used during the process, the heat is lost from his body. As a result Harold felt cold.

b)The tower prevented evaporation from taking place by absorbing the water in Harold's.

37)a)Most of the caterpillars have change into butterfly.

b)The hibiscus plant provides food for the butterflies, and the butterflies help the hibiscus flower to pollinate.

38) There is an opening for air to escape in set-up B, therefore there is more space for more oil to occupy in set-up A, the air is not able to escape to allow more oil to occupy space.

39) a) Peter should conduct the experiment in a completely dark room because the light sensor can just read the light source and not the room light. The reading might be incorrect, causing the test to be unfair.

b) Material R. because it can reflect the most light from the furthest distance.

40) a) N S

b) Magnetic force can act from a distance.

41) Box A:

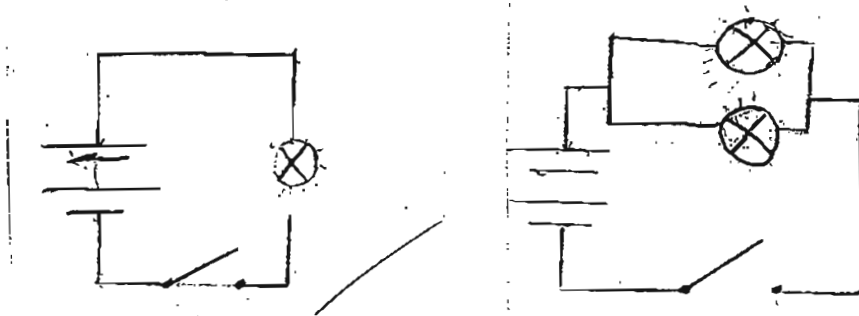

Box B:

42) F, T, Not

43) When the switch is closed, it forms a closed circuit/electricity flows through the circuit. The iron rod will be attracted and move towards the electromagnet, causing the striker to hit the bell. The circuit is now opened because the aluminium screw is not touching the iron rod. The spring returns the iron rod to the original position as the iron rod is no longer attracted by the electromagnet.

44) a) Overloading the power socket is dangerous because when one of the plugs trips it may cause a big fire.

b) The rubber covering is an insulator and will not give the person an electric shock.