



**NAN HUA PRIMARY SCHOOL
SEMESTRAL ASSESSMENT 1 – 2011
PRIMARY 5**

SCIENCE

BOOKLET A

30 Multiple Choice Questions (60 marks)

Total Time for Booklets A and B : 1 hour 45 minutes

INSTRUCTIONS TO CANDIDATES

1. Write your name and index number in the space provided.
2. Do not turn over the page until you are told to do so.
3. Follow all instructions carefully.
4. Answer all questions.
5. Shade your answers in the Optical Answer Sheet (OAS) provided.

Marks Obtained

Booklet A		/ 60
Booklet B		/ 40
Total		/100

Name: _____ () **Class:** P 5 _____

Date : 12 May 2011

Parent's Signature: _____

Section A: (30 x 2marks = 60marks)

For each question from 1 to 30, four options are given. One of them is the correct answer. Make your choice (1, 2, 3 or 4). Shade the correct oval (1, 2, 3 or 4) on the Optical Answer Sheet.

1. Sally set up an experiment to illustrate the water cycle.

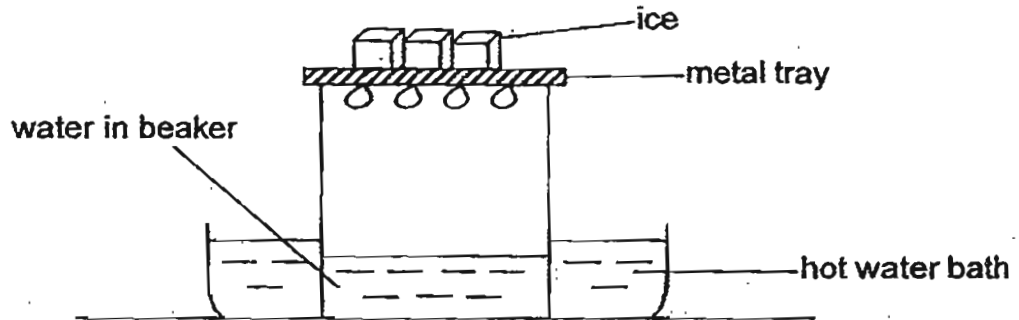

Sally recorded the processes that represent the water cycle. Which of the following process(es) is /are necessary for water cycle to take place?

- A Melting of the ice.
 - B Condensation at the metal tray.
 - C Evaporation of the hot water bath.
 - D Evaporation of the water in the beaker.
- B and D only C and D only
 A, B and C only A, B, C and D

2. Which of the statement(s) is/are true about the importance of water cycle?

- A The water cycle helps to clean air.
 - B The water cycle ensures a supply of fresh water on Earth.
 - C The water cycle provides all living things with water for their survival.
- A and B only A and C only
 B and C only A, B and C

3. The chart below shows plants being classified into two groups.

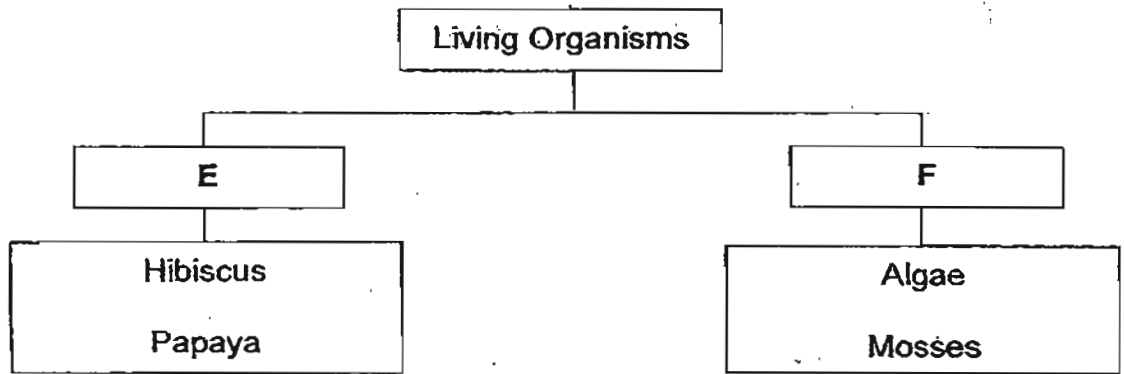

Which one of the following is the most suitable heading for group E and F?

	E	F
<input checked="" type="checkbox"/> (X)	Reproduce by seeds	Reproduce by spores
<input checked="" type="checkbox"/> (X)	Can make food	Cannot make food
<input checked="" type="checkbox"/> (X)	Do not bear flowers	Bear flowers
<input checked="" type="checkbox"/> (X)	Non poisonous	Poisonous

4. Salim prepared 3 pots, A, B and C, and put 3 chilli seeds into each pot. The table below shows the conditions of each pot.

Pot	Conditions			
	Water	Oxygen	Light	Temperature(°C)
A	No	No	Yes	4
B	Yes	Yes	Yes	28
C	Yes	Yes	No	30

In which pot(s) will the seeds germinate?

- | | |
|--|--|
| <input checked="" type="checkbox"/> (X) A only | <input checked="" type="checkbox"/> (X) B only |
| <input checked="" type="checkbox"/> (X) B and C only | <input checked="" type="checkbox"/> (X) A, B and C |

5. The diagram shows some pollen grains on a stigma.

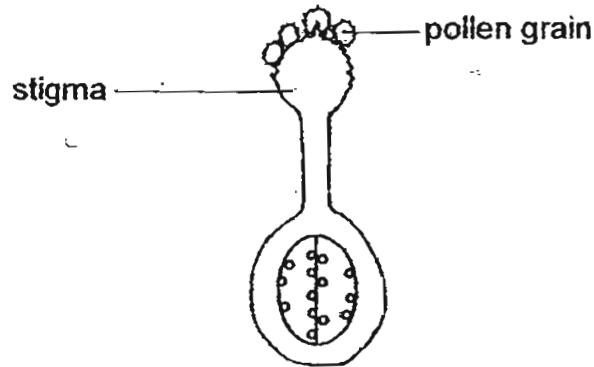

Which of the following statements are true about what will occur after pollination?

- A The pollen will travel down the pollen tube.
- B A pollen tube will grow through the style to reach the ovules.
- C Fertilisation will occur when the female reproductive cell fuses with the male reproductive cell.

- (1) A and B only
- (2) A and C only
- (3) B and C only
- (4) A, B and C

6. Flowers from the same hibiscus plant were put into four groups, A, B, C and D. In each group, one part of the flower was removed. Pollen grains from the same hibiscus plant were dusted on the remaining parts of the four groups of flowers.

It was observed that the flowers in only one group developed into fruits.

Which one of the following correctly indicates the group where the flowers successfully developed into fruits?

	Group	Fertilisation occurring	Parts removed
(1)	A	Yes	Anthers
(2)	B	Yes	Ovules
(3)	C	No	Filament
(4)	D	No	Ovary

7. Which of the following correctly describes the development of the young in a pregnant mother?

- (1) zygote → embryo → foetus → baby
 (2) zygote → embryo → baby → foetus
 (3) embryo → zygote → baby → foetus
 (4) embryo → zygote → foetus → baby

8. Study the diagrams below.

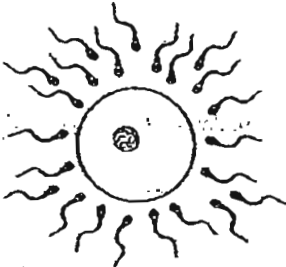

A

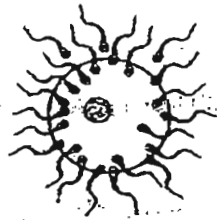

B

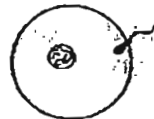

C



D

Which of the following confirm(s) that fertilization has taken place?

- (1) C only
 (2) D only
 (3) A and B only
 (4) A, B and D only

9. Which of the following statement(s) about the embryo is/are true?

- A The embryo obtains digested food from the mother.
 B The waste of the embryo is sent to the mother for removal.
 C The embryo respire by taking in the dissolved oxygen from the fluid surrounding it.

- (1) B only
 (2) A and B only
 (3) A and C only
 (4) A, B and C

10. Which of the following statement(s) about the male reproductive cell of the plant and the human is/are true?

- A There is a pair of feelers on the male reproductive cells of the human but not the plant.
- B The male reproductive cells of the plant and human are produced in the male reproductive organ.
- C The male reproductive cell of the human will move towards the female reproductive cell but the male reproductive cell of the plant will not move towards the female reproductive cell.

- (1) A only
- (2) A and B only

- (3) B only
- (4) A, B and C

11. The diagram shows the water cycle.

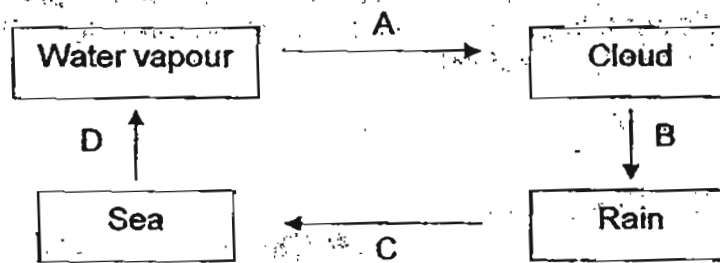

Which arrow(s) indicate(s) heat loss?

- (1) A only
- (3) A and C only

- (2) D only
- (4) B and D only

12. Why does Singapore need to produce NEWater?

Which statement(s) is/are true?

- A The demand for fresh water is too high.
- B There are insufficient natural water resources.
- C To be less dependant on external water sources for Singapore.

- (1) A only
- (2) B and C only

- (3) B only
- (4) A, B and C

13. The diagrams show a process taking place between the flowers of the same plant.

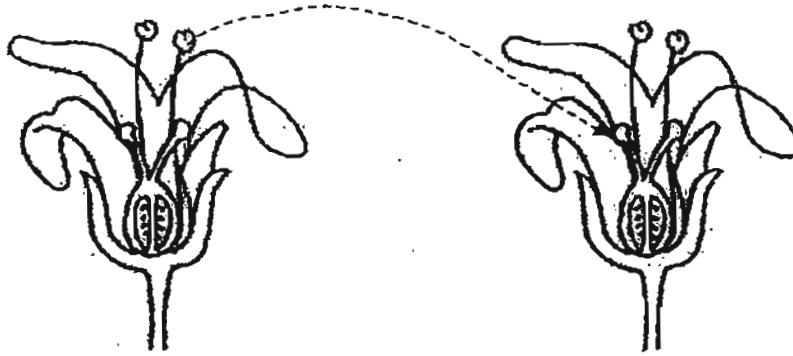

Which of the following statement about the above process is true?

- (1) With this process, the ovule can develop into fruit.
 - (2) During this process, the spores will land on the stigma.
 - (3) With this process, competition with the parent plant will not occur.
 - (4) Without this process, the plant will not be able to reproduce and will eventually be extinct.
14. The diagram shows a cluster of fungi.

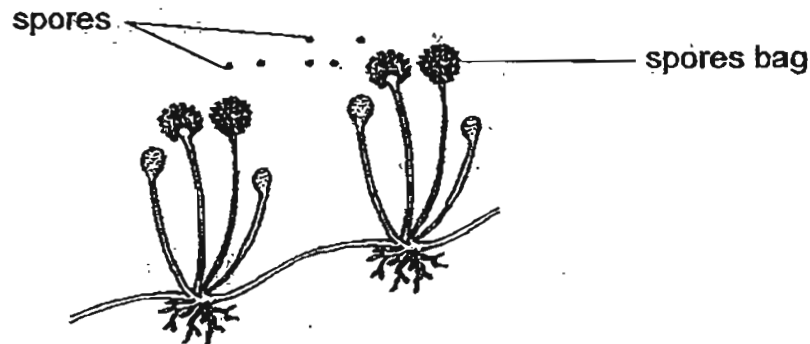

Which of the following statement(s) about the reproduction of fungi is/are true?

- A The spores can be dispersed by wind.
 - B In order for the fungi to reproduce, the spores must land on the spores bag.
 - C A male reproductive cell and a female reproductive cell are needed for fertilization to occur.
- (2) A only (2) B only
 (2) B and C only (4) A, B and C

15. The diagram below shows a flower.



Based on the picture of the flower above, which of the following characteristics of the flower show that it is wind pollinated?

- A The flower has large petals.
- B The flower has no sweet scent.
- C The stigma is hanging out of the flower.
- D The anther is hanging out of the flower.

- (1) A and C only
- (8) C and D only

- (2) B and C only
- (4) B, C and D only

16. The table shows the characteristics of plants A, B, C and D. A tick (✓) in the box indicates the presence of the characteristics of the plant.

Plant	A	B	C	D
Bears fruit	✓		✓	✓
Grows on land		✓	✓	

Based on the information provided in the table above, which one of the following shows the correct classification of the plants A, B, C and D respectively?

Plants			
Flowering		Non-flowering	
Aquatic	Land	Aquatic	Land
<input checked="" type="checkbox"/> (1) A	C, D		B
<input checked="" type="checkbox"/> (2)	B	A	C, D
<input checked="" type="checkbox"/> (3) D	B	A	C
<input checked="" type="checkbox"/> (4) A, D	C		B

17. Study the family tree below. A brief physical description of the different family members is also provided.

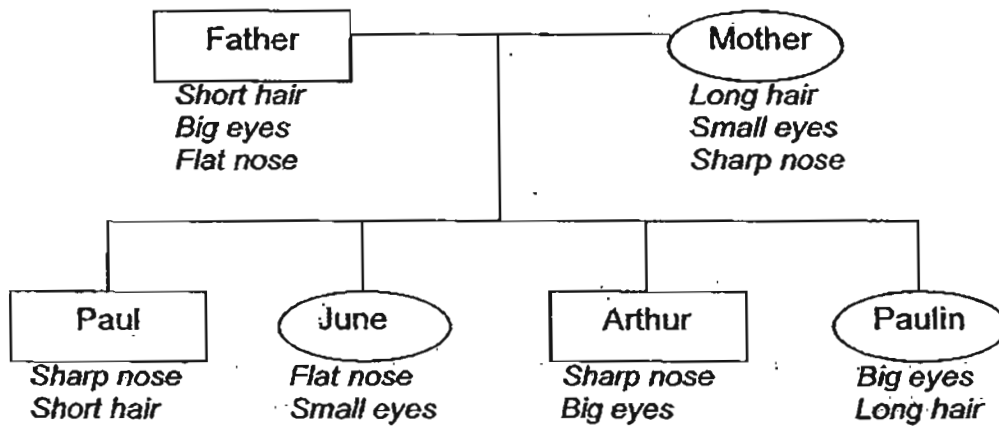

Which of the following child/children inherited only one characteristic from each parent?

- (1) Paul only
 (2) June and Arthur only
 (3) June, Arthur and Paulin only
 (4) Paul, June, Arthur and Paulin
18. In which part of the female reproductive system does development of the embryo take place?

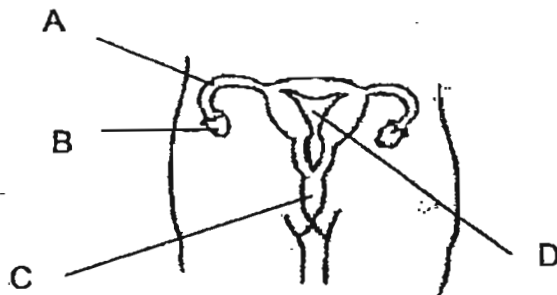

- (1) A
 (2) B
 (3) C
 (4) D

19. Study the diagram of the female reproductive organ below.

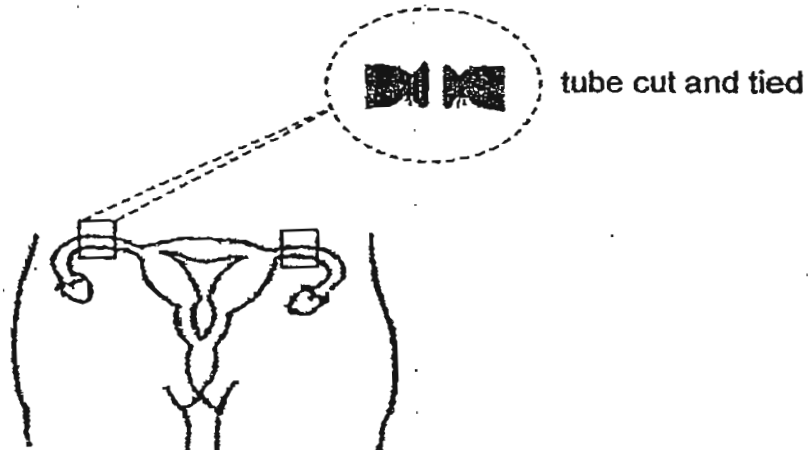

For the purpose of family planning, a medical procedure was carried out such that the fallopian tube was cut and tied.

Based on the medical procedure done above, which of the following statement is true?

- (1) The process will ensure that no eggs will be released.
 - (2) The process will ensure that more than one egg will be released.
 - (3) The process will ensure that fertilization will not take place.
 - (4) The process will ensure that fertilization will definitely take place.
20. There are similarities in the sexual reproduction in both animals and flowering plants.

Which of the statement(s) is/are true of sexual reproduction in both animals and flowering plants?

- A Fertilization occurs in both animals and flowering plants.
- B Female and male reproductive cells are required in the reproduction.
- C Pollination agents are required to transfer the male reproductive cells to female reproductive cells.

- (1) B only
- (2) C only
- (3) A and C only
- (4) A, B and C

21. Which part of the male reproductive system of the human and the plant perform the same function?



	Male	Plant
(1)	A	D
(2)	A	B
(3)	C	D
(4)	C	B

22. The shadow of a pole is observed at different times of a day. Which one of the following diagrams shows the shadow of the pole formed at 6 pm?

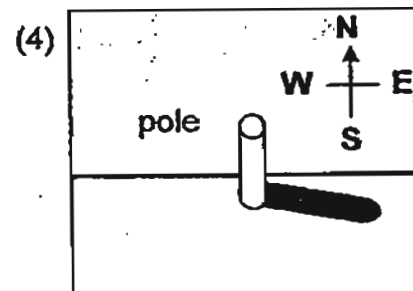
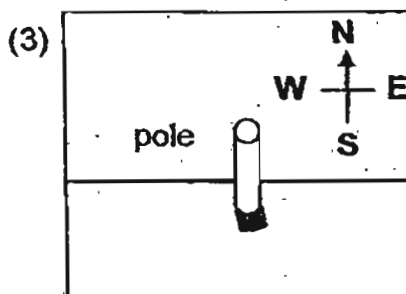
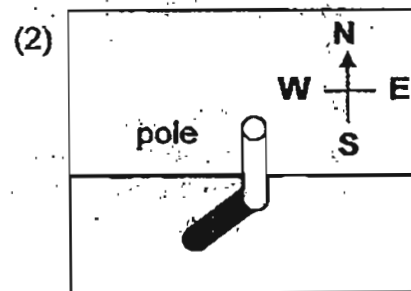
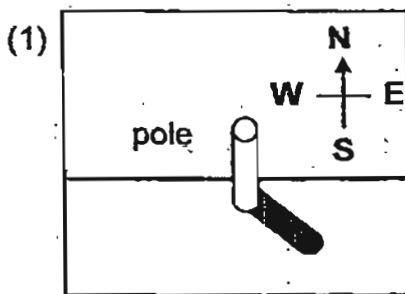

23. Tom is looking into the periscope.
Which of the following diagrams shows the correct direction of light rays?

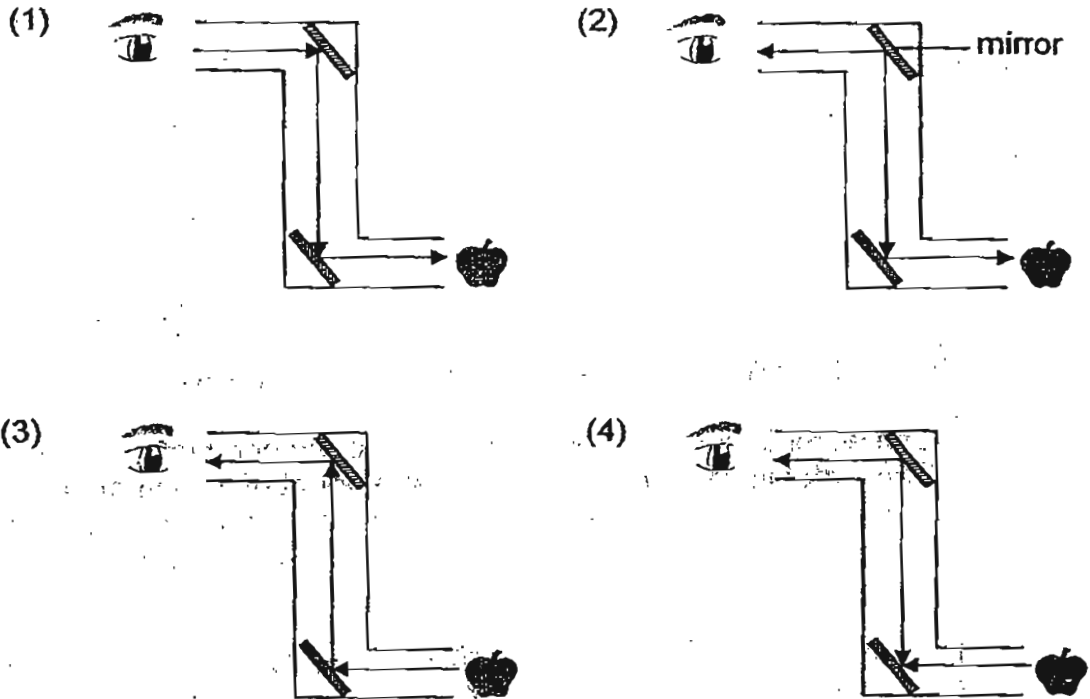

24. In an experiment to investigate the amount of light that passes through 4 materials, W, X, Y and Z. A datalogger with light sensor is used to measure the amount of light that has passed through the materials.

The graph below shows the amount of light recorded by the light sensor when light is shone on the 4 materials.

Which line graph best represents the materials used to make into spectacle lens?

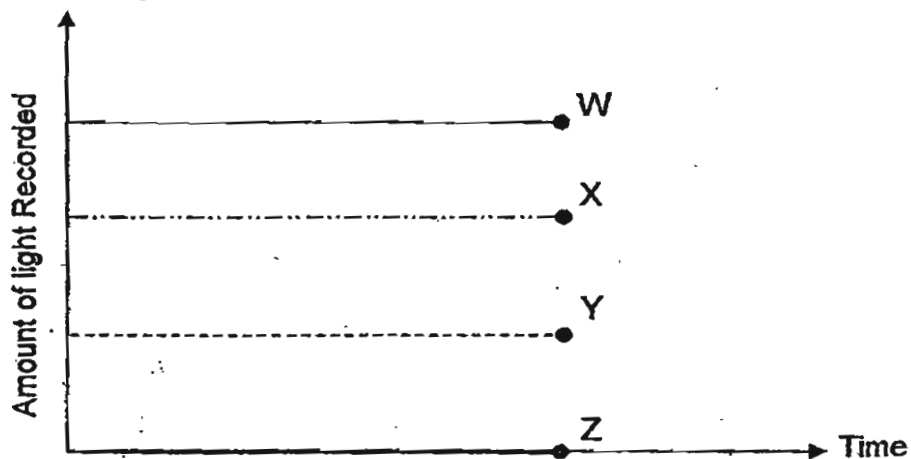

- (1) W (2) X
(3) Y (4) Z

25. The diagram below shows two beakers, X and Y, filled with different amounts of water. The water in both beakers was heated up to 80°C .



Which of the following statements are true about the two beakers of water?

- A The water in both beakers has the same temperature.
- ~~B~~ The water in both beakers has same amount of heat energy.
- ~~C~~ The water in beaker Y has more amount of heat energy than beaker X.
- ~~D~~ The water in beaker Y would evaporate faster than the water in beaker X.

- ~~(1)~~ A and C only
- ~~(3)~~ A, C and D only

- ~~(2)~~ C and D only
- ~~(4)~~ A, B and D only

26. Mary heated a beaker of water and recorded the temperature change in the graph shown below. At one point in the experiment, she added some ice cubes into the beaker of water.

At which point of the graph, A, B, C or D, was the ice cubes added to the beaker of water?

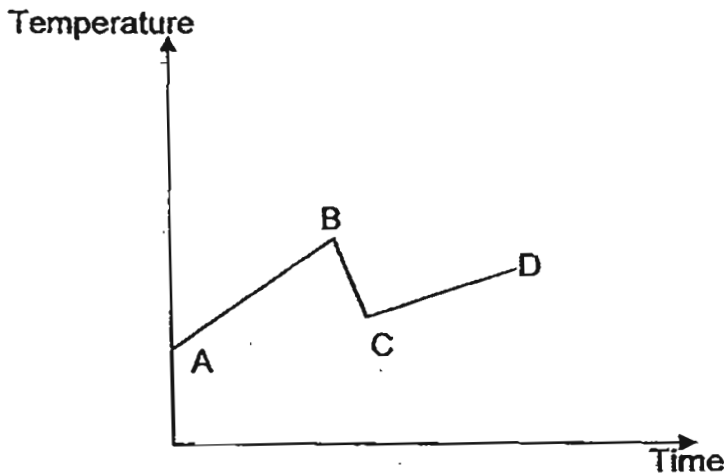

- (1) A
- (3) C

- (2) B
- (4) D

27. Study the flowchart below.

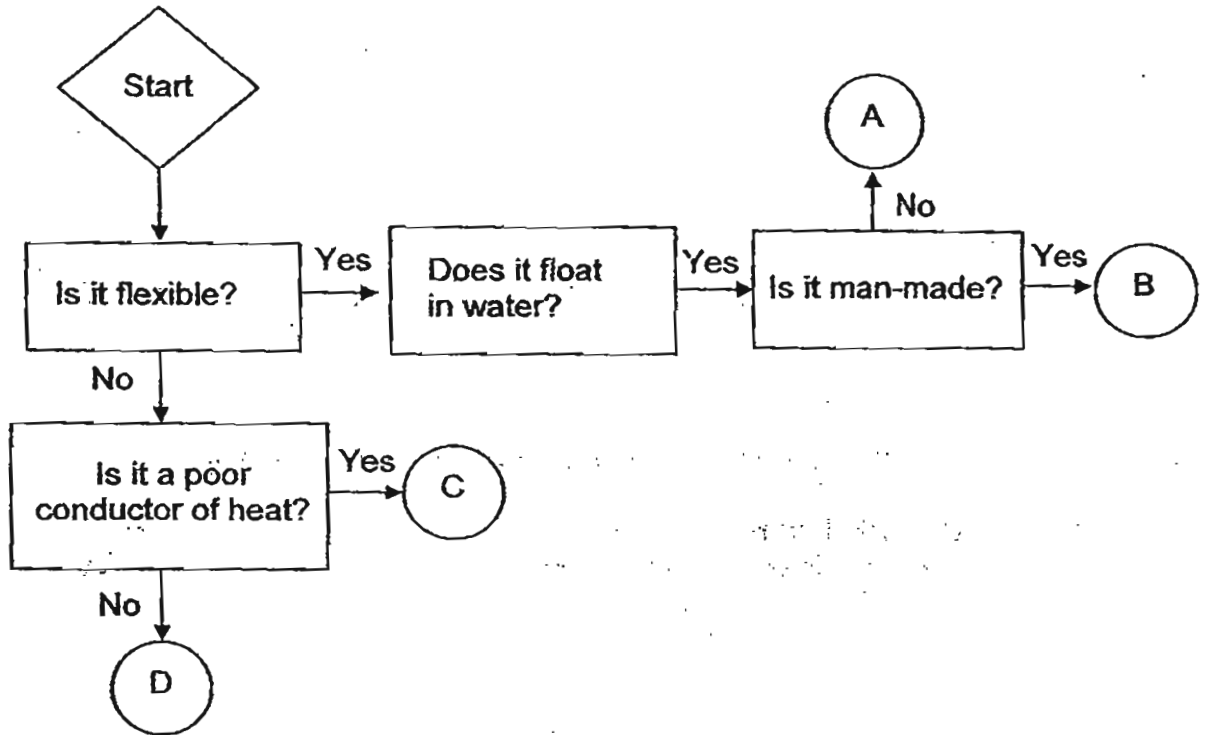

Which of the following is the most suitable for making part E and F of the iron?

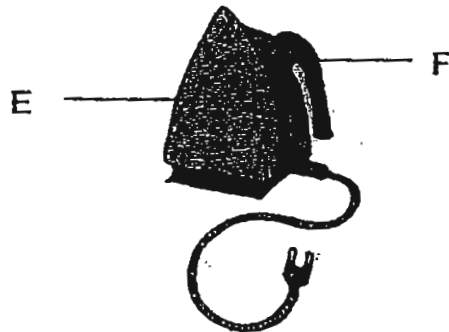

	Part E	Part F
(1)	C	A
(2)	C	D
(3)	D	C
(4)	A	B

28. Study the classification chart below carefully.

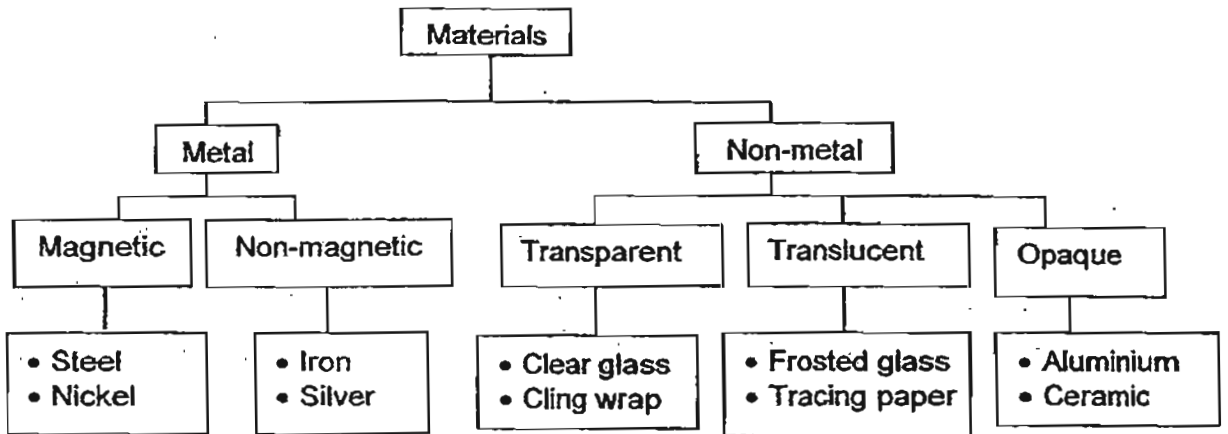

Which of the above materials are **wrongly** classified?

- (1) Nickel, Iron and silver.
- (2) Iron, silver and aluminium
- (3) Nickel and frosted glass
- (4) Iron and aluminium

29. Ravi conducted several tests on materials A, B, C and D, and recorded the results in the table below.

Characteristics \ Material	A	B	C	D
flexible		√		√
Stretchable		√		
fragile	√			
Waterproof	√		√	√

Which material should he use to make a T-shirt ?

- (1) A
- (2) B
- (3) C
- (4) D

30. Jane wants to investigate how sugar water can affect the growth of a plant. She had four pots of identical plants. Each day, she watered the pots of plants and measured and recorded the height of the plants.

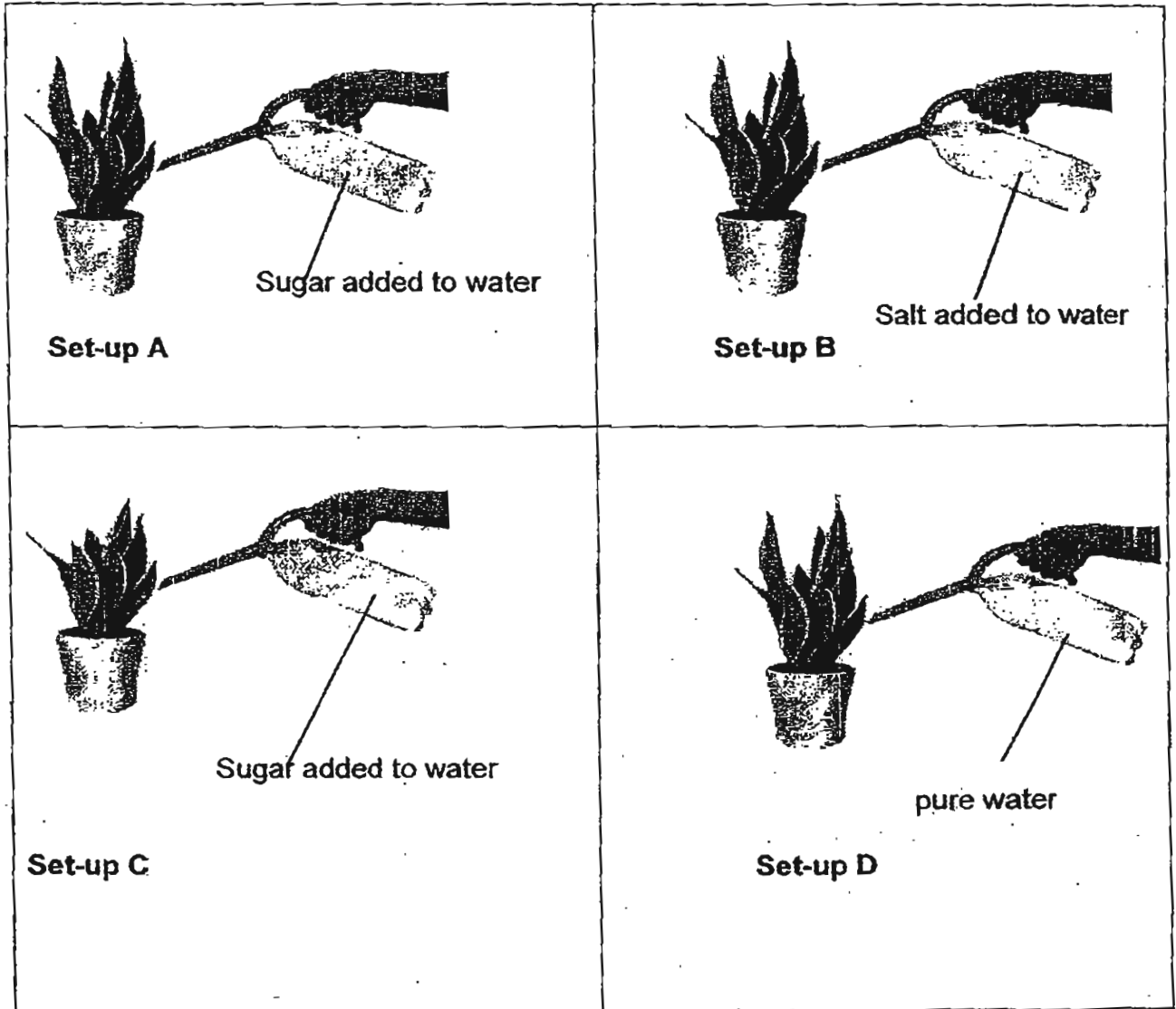

Which set-ups should she use to compare for her experiment in order to arrive at a conclusion?

- (1) Set-ups A and B only
- (2) Set-ups A and D only
- (3) Set-ups B and C only
- (4) Set-ups C and D only



**NAN HUA PRIMARY SCHOOL
SEMESTRAL ASSESSMENT 1 – 2011
PRIMARY 5**

SCIENCE

BOOKLET B

14 Open-ended questions (40 marks)

Total Time for Booklets A and B: 1 hour 45 minutes

INSTRUCTIONS TO CANDIDATES

1. Write your name and index number in the space provided.
2. Do not turn over the page until you are told to do so.
3. Follow all instructions carefully.
4. Answer all questions.
5. Write your answers in this booklet.

Marks Obtained

Section B		/40
------------------	--	------------

Name: _____ () **Class: P 5** _____

Date : 12 May 2011

Parent's Signature: _____

Section B: (40marks)

Write your answers to question 31 to 44.

The number of marks available is shown in brackets [] at the end of each question or part question.

31. The diagrams, A and B, show the water cycle and drying of the T-shirt.

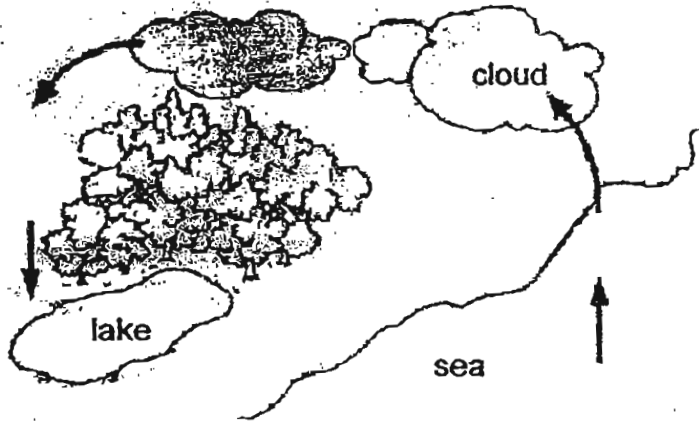

Diagram A

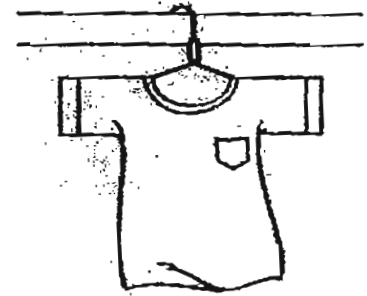

Diagram B

(a) Name the process that is found in both the water cycle and the drying of the T-shirt? [1]

(b) A pupil commented that the water in the lake can come from the wet T-shirt. Do you agree with this statement? Explain your answer. [2]

Score	3
-------	---

32. Study the diagrams of two adult trees below.

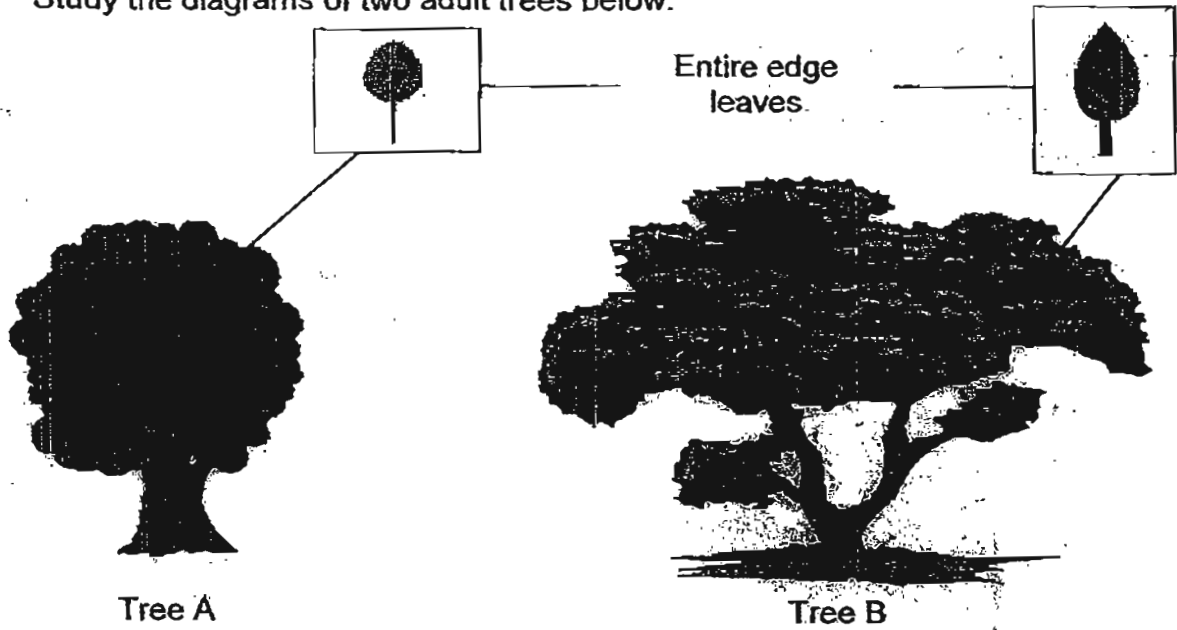

A scientist took the pollen from the flower in Tree A and pollinated the flowers in Tree B. Fertilization took place producing a new offspring.

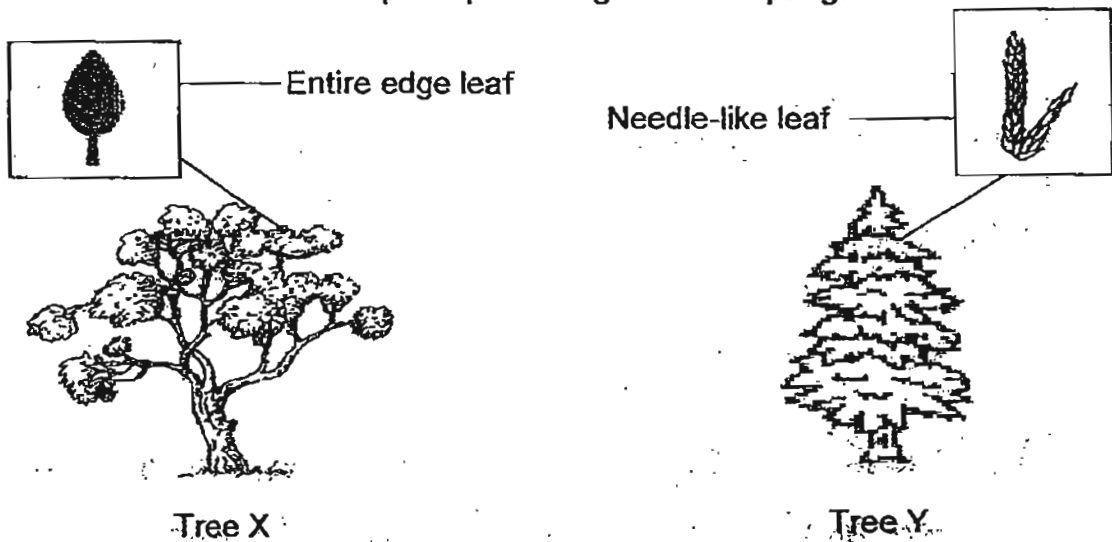

(a) Which one of the trees, X or Y, is the offspring of the adult trees, A and B. Write down the characteristic that is found in both the parents plant and the offspring. [1]

(b) Explain your answer for part (a). [1]

Score	2
-------	---

33. Study Jonathan's family tree below.

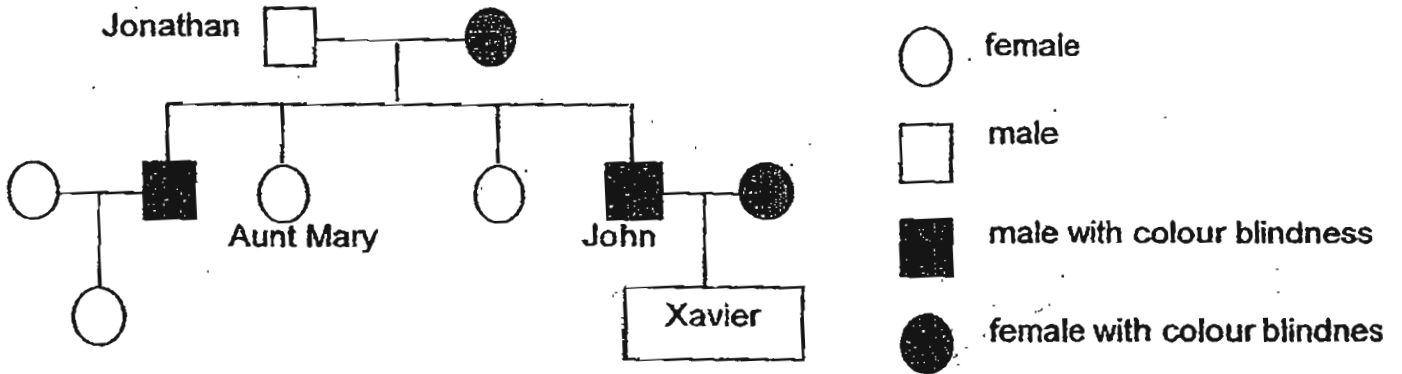

(a) Will Xavier have colour blindness? Explain your answer. [1]

(b) Xavier is found to have similar physical characteristics with his Aunt Mary. Explain why this is possible? [1]

Score	2
-------	---

34. Residents living in an estate face a problem when they drive towards a T-junction. They could not see oncoming cars on the right because their view is blocked by the houses and residents' cars parked outside their houses.

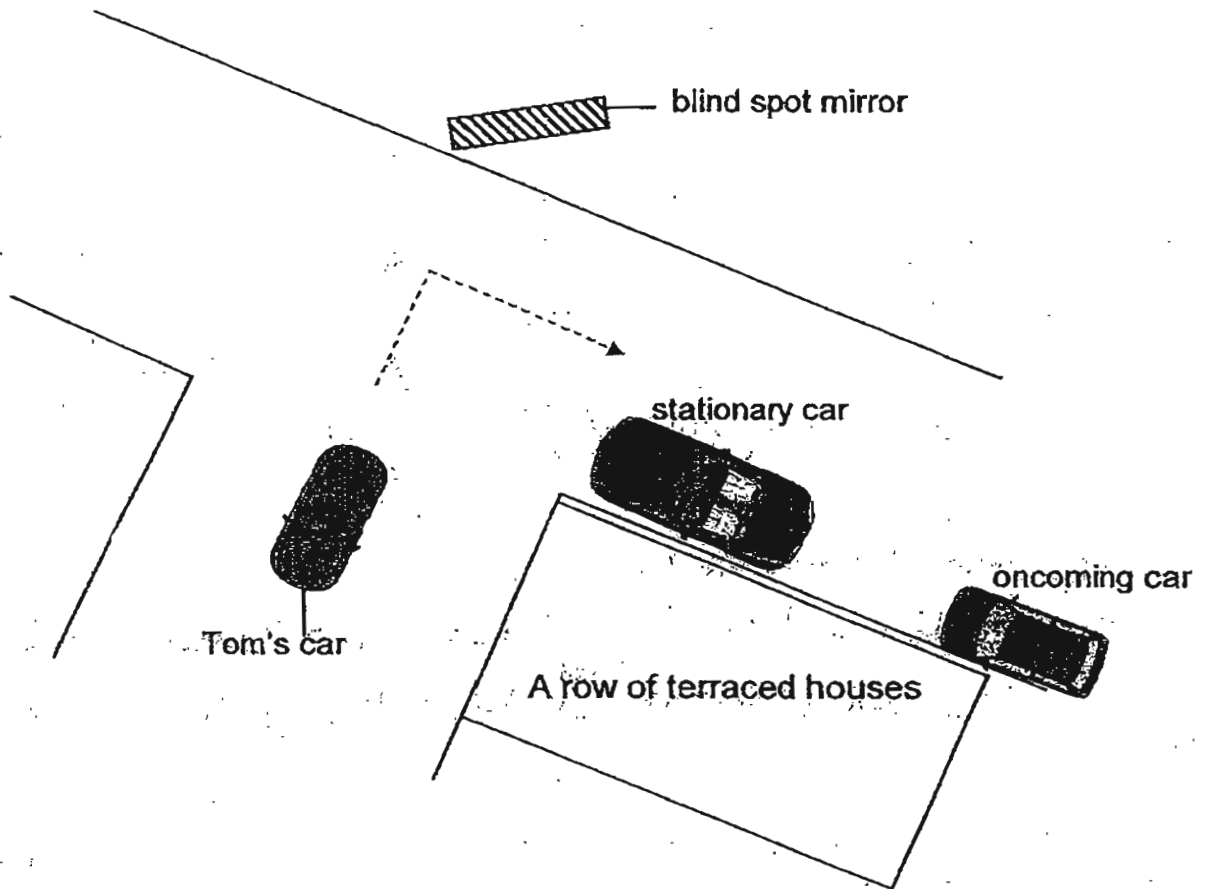

In his car, Tom was at the T-junction and his view is blocked by the houses and stationary car.

- (a) How did the blind spot mirror help Tom to see the oncoming car? [1]

- (b) Tom was unable to see the oncoming car without the blind spot mirror. What property of light can you conclude from this observation? [1]

Score	2
-------	---

35. Mary recorded the temperature of the air in a bottle as shown in Diagram 1. Then she placed a few hot stones in the same bottle and closed the bottle. After a few minutes, she recorded the temperature of air in the bottle as shown in Diagram 2.

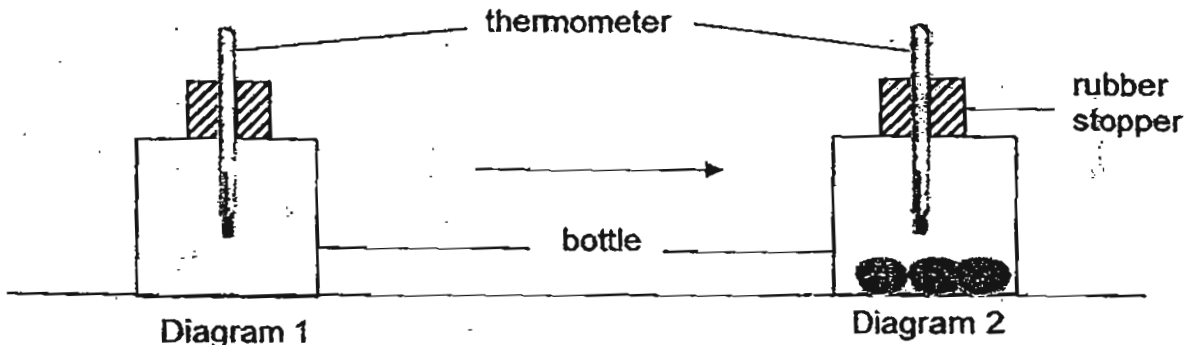

- (a) What will happen to the temperature in the bottle in diagram 2? Explain your answer. [1]

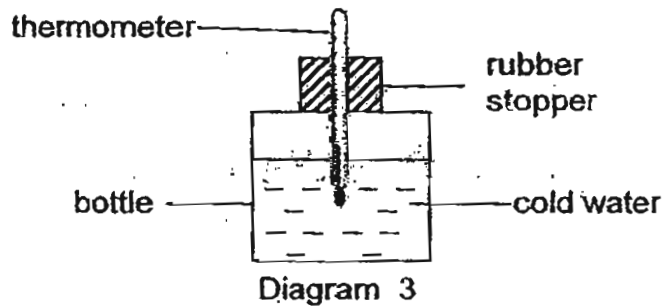

Mary wanted to find out if the type of material used for the bottle affects the temperature of the cold water in the bottle. She carried out an experiment with bottle made of different materials. She controlled the variables as shown in the table below.

	Constant Variable (thing kept the same)	Independent Variable (thing that changed)
Material of bottle		✓
Temperature of cold water		✓
Material of stopper	✓	
Size of bottle	✓	
Thickness of material	✓	

- (b) Do you think Mary's experiment was a fair one? Give a reason for your answer. [2]

36. The diagram shows a fish tank.

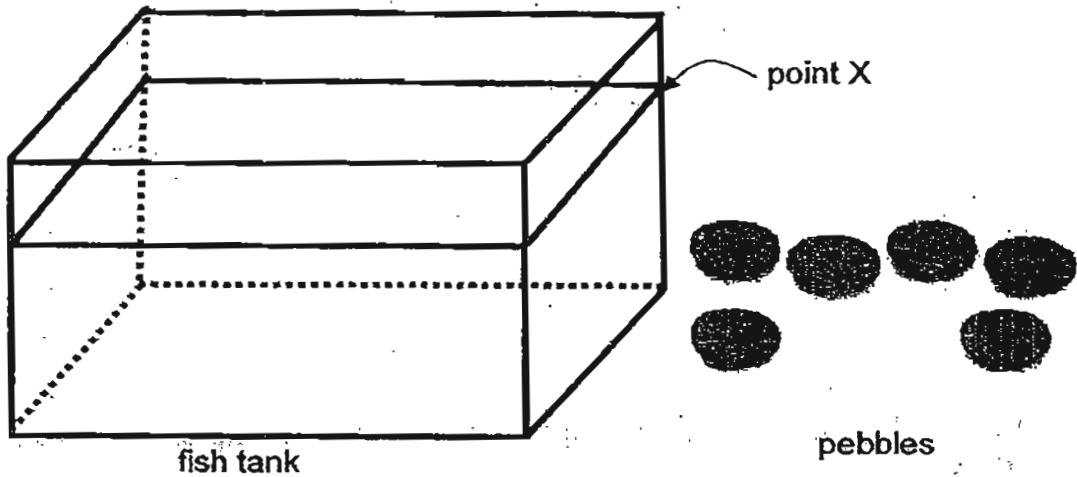

Tom needed to fill a fish tank with water up to point X in order to keep his fish. He decided to use some pebbles to reduce the amount of water needed to fill the tank to point X.

(a) Suggest how he could use the pebbles to achieve his aim? [1]

(b) Give a reason for your answer in (a). [2]

Score	3
-------	---

37. A few days after Jim had put a slice of freshly baked bread into an airtight container, he saw some black-greenish bread mould on the bread.

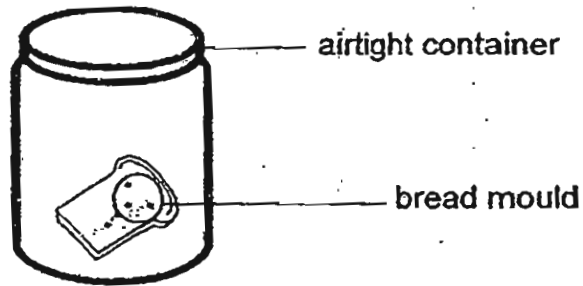

- (a) How did bread mould get to the piece of bread if the container was airtight? [2]

- (b) If a piece of bread that was toasted in the oven was put into the airtight container after being cooled, will the bread mould grow? Explain your answer clearly. [2]

Score	4
-------	---

38. The diagram shows a germinating seed.

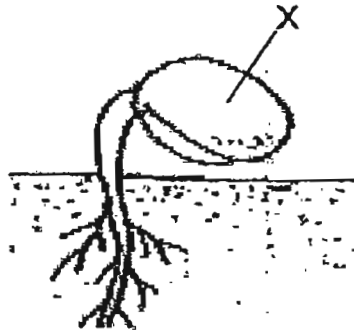

(a) Is the germinating seed above able to make its food?
Explain your answer.

[1]

(b) Name part X.

[1]

(c) If part X is removed, what will happen to the germinating seed? Explain your answer.

[1]

Score	3
-------	---

39. The diagrams show the male reproductive cells of a human and plant respectively.



sperm



pollen grain

(a) On the diagram below, name and label the part on the sperm that fuses with the female egg. [1]

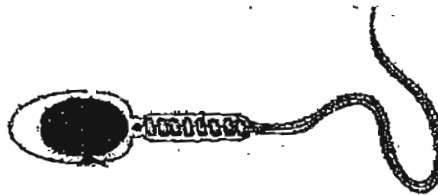

(b) Explain why the sperm is able to move on its own to reach the egg? [1]

(c) The pollen cannot move on its own. How does the pollen reach the egg? [1]

Score	3
-------	---

40. Study the diagram of the reproductive organ of the human.

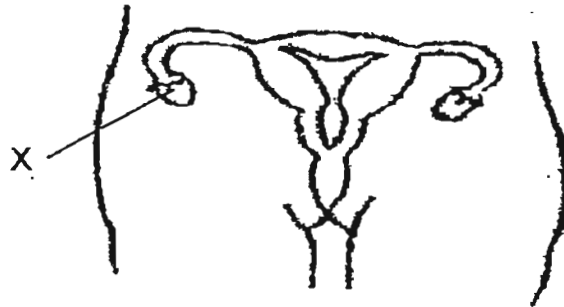

Female reproductive system

(a) Name the part marked X. [1]

(b) What is the function of the part marked "X"? [1]

Flower X was kept in isolation and precaution was taken to ensure that it will not receive any pollen before its stigma was removed.

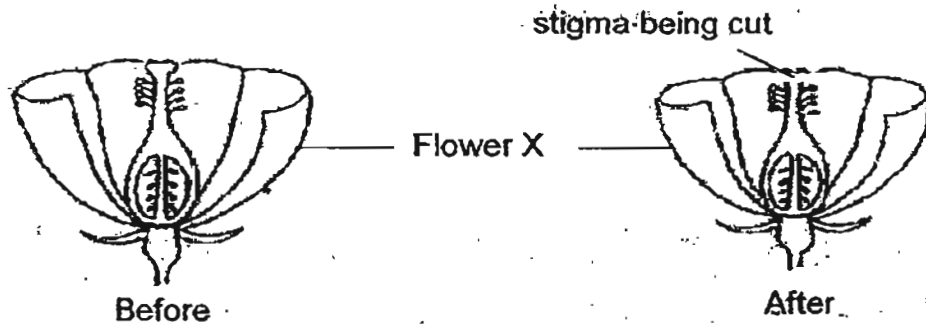

(c) If the stigma in Flower X is removed, will fertilization occur? [2]

(d) How are the insects attracted to the flower above? [1]

Score	5
-------	---

41. Ali set up an experiment as shown below. He placed paper of different materials, Y and Z, of the same thickness at position X. The distance between the paper and torch, as well as the distance between the paper and the datalogger are the same.

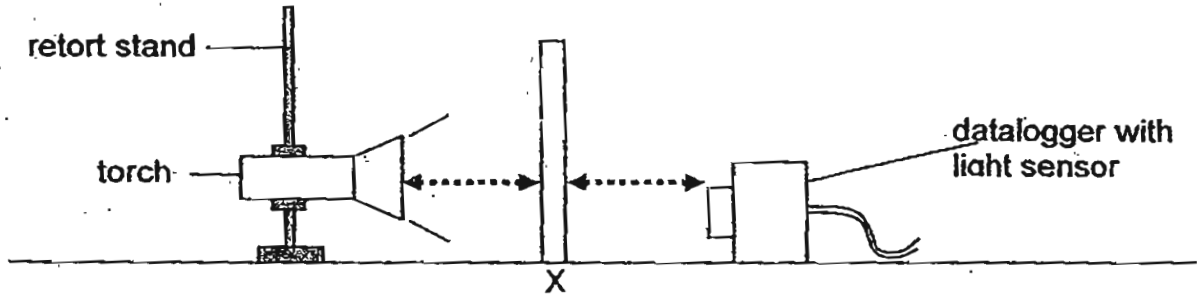

The set-up was placed in dark room with a torch shining on the paper. The amount of light measured was recorded in the table shown below.

Paper made of material :	Amount of light recorded (lux)	Amount of temperature recorded ($^{\circ}\text{C}$)
Y	0	30
Z	52	42
Glass	87	51

- (a) What can he conclude about Material Z? [1]

- (b) The temperature of the area where the datalogger was situated was also taken and recorded as shown in the table above. What is the relationship between the amount of light that passed through the materials and the temperature of the area where the datalogger was situated? [1]

- (c) The toy grasshopper will hop around when light is received by the solar panel.

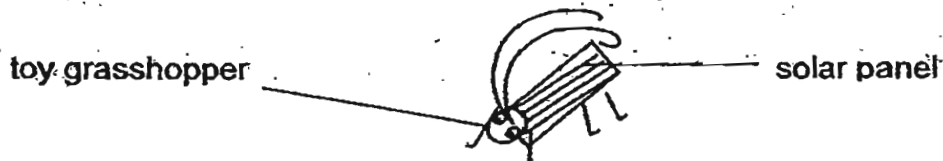

- Which material, Y or Z, should be used to make a packing box to contain the toy grasshopper so that it will not hop around? Explain your answer. [1]

42. David took three containers made of different materials A, B and C. He put the same number of ice cubes into each of the container at the same time. He measured the time taken for the similar sized ice cubes in each container to melt respectively

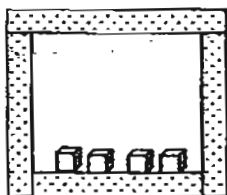

Container made of material A

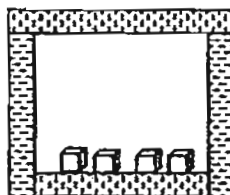

Container made of material B

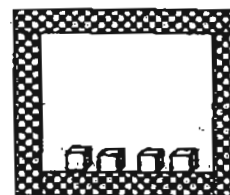

Container made of material C

The results were recorded.

Container made of material:	Time taken to melt the ice cubes
A	1 h 10 min
B	56 min
C	2 h 25 min

- (a) Which material, A, B or C, prevents the ice cubes from melting most quickly? Explain your answer clearly. [1]

- (b) Which material is best used to keep soup hot for the longest period? Explain your answer clearly. [1]

Score	2
-------	---

43. Kathy conducted an experiment to test for the hardness of two different materials, A and B. She recorded her observations in the table below.

A tick (✓) indicates the presence of scratch marks on each material.

Material	Presence of scratch marks
A	✓
B	

- (a) Which material is harder than the other? Explain your answer. [1]

The diagram below shows a construction forklift truck that is used to lift heavy objects.

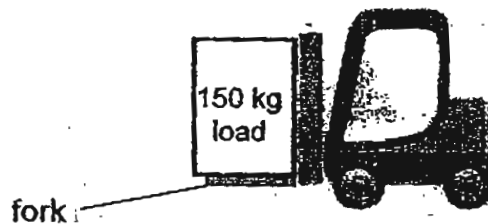

- (b) Will the material you have chosen in part (a) be suitable for making the fork of the truck? Explain your answer. [1]

Score	2
-------	---

44. The diagram shows the transport system of a plant.

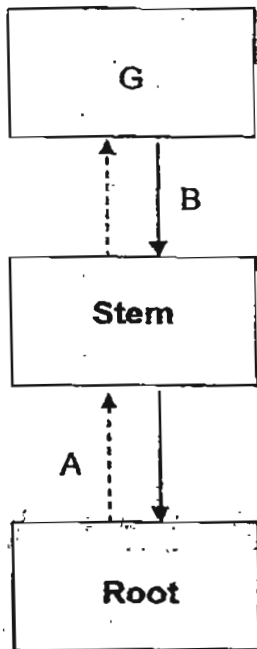

(a) What is the substance that is found in A? Which part of the plant carries this substance?

[1]

If you look closely at the stems of flowers immersed in vases of water in a flower shop, you would notice that the ends are cut diagonally rather than horizontally across.

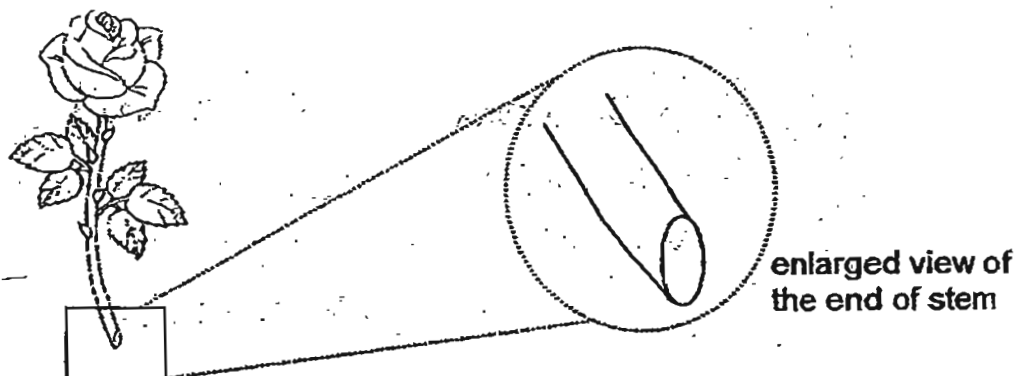

(b) Why are the ends of flower stems cut diagonally?

[2]

Score	3
-------	---



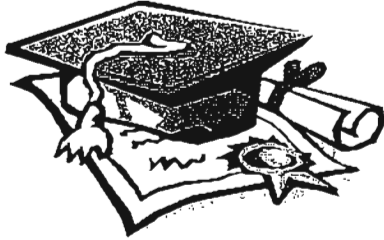

ANSWER SHEET

EXAM PAPER 2011

**SCHOOL : NAN HUA
SUBJECT : PRIMARY 5 SCIENCE**

TERM : SA1

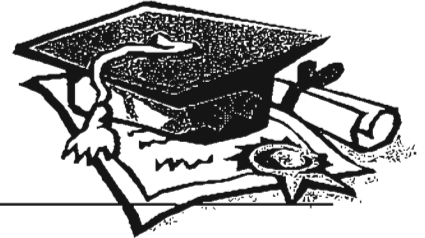

Q1	Q2	Q3	Q4	Q5	Q6	Q7	Q8	Q9	Q10	Q11	Q12	Q13	Q14	Q15	Q16	Q17
1	3	1	3	3	1	1	2	2	2	1	4	4	1	3	4	2

Q18	Q19	Q20	Q21	Q22	Q23	Q24	Q25	Q26	Q27	Q28	Q29	Q30
4	3	3	4	4	3	1	1	2	3	4	2	2

31)a)Evaporation.

b)Yes. Because when the from the wet T-shirt evaporates, it condenses into tiny water droplets and form clouds. And when the coater droplets are too heavy, they will fall back to earth as rain.

32)a)Tree X. Their leaves are both entire edged.

b)During fertilization, the adult tree passed down some of their characteristics to the offspring.

33)a)Yes. Because both his parents have colour blindness and when his parents past down their characteristics to Xavier, he may also have colour blindness.

b)Xavier inherited some of the characteristics from his grandparents through his father. These similar characteristics are also passed on from Xavier grandparents to Aunt Mary.

34)a)The mirror reflects light from the oncoming car into Tom's eye.

b)Light travels in a straight line.

35)a)The temperature will rise. The hot stones lost their heat to the surrounding air. When the stones lost heat, the surrounding air gained heat therefore the temperature will rise.

b)No. There shown only one independent variable which is the material of the bottle changing the temperature of the water may affect the result of the experiment.

36)a)He should put all the pebbles in to the fish tank.

b)When the pebbles are put in the tank they will occupy space so less water will be needed to fill the tank up to point X.

37)a) There were already spores present in the air in the container before the lid is tightened.

b) No, because the bread mould needs moisture to grow. The heat in the oven had evaporated the water in the bread.

38)a) No. The seedling does not have any green leaves so there is no chlorophyll to trap light to make food for the seedling.

b) Seed leaves.

c) It will die. When part X is removed, it has no more food supply therefore it will die.

39)a)  nucleus

b) It has a tail that enables it to swim.

c) The pollen grains are carried by wind insect animals and deposited on the stigma and there after grow a pollen tube down the style to reach the egg in the ovules.

40)a) Ovary

b) It produces the eggs.

c) No. Because when the stigma is being cut, the pollen grains cannot enter the stigma.

d) By the colour of the flower or by smell the flower gives out.

41)a) material Z is translucent.

b) The greater the amount of light passed the materials, the higher the temperature in the area where the datalogger was situated.

c) The box made of material Y should be used. The material will not allow light to pass through the solar panel will not receive light and the toy will not hop.

42)a) Material C. The ice took the longest time to melt in container made out of material C. material C is the poorest conductor of heat so the ice will gain heat most slowly.

b) Material C. material C is the worst conductor of heat, so the hot will lose heat most slowly.

43)a) B is harder than A. material A could be scratched but material B could not.

b) Material B will not be suitable to make the fork of forklift. Hardness does not represent strength. Even though material B is harder it may not be strong enough to withstand the weight of the load.

44)a) Water. The xylem.

b) Diagonally cut stem has a bigger surface area exposed to water so the flower can absorb more water.