

Name: _____ ()

Class: Primary 5 _____

CHIJ ST NICHOLAS GIRLS' SCHOOL



Primary 5

Semestral Assessment 2 – 2011

SCIENCE

BOOKLET A

2nd November 2011

Total Time for Booklets A and B: 1 hour 45 minutes

30 questions
60 marks

Do not open this booklet until you are told to do so.

Follow all instructions carefully.

Answer all questions.

Shade your answers in the Optical Answer Sheet (OAS) provided.

This paper consists of 25 printed pages.

Section A : (30 x 2 MARKS)

For each question from 1 to 30, four options are given. One of them is the correct answer. Make your choice (1, 2, 3 or 4). Shade the correct oval (1, 2, 3 or 4) on the Optical Answer Sheet.

1. The diagram below shows the parts of a cell.

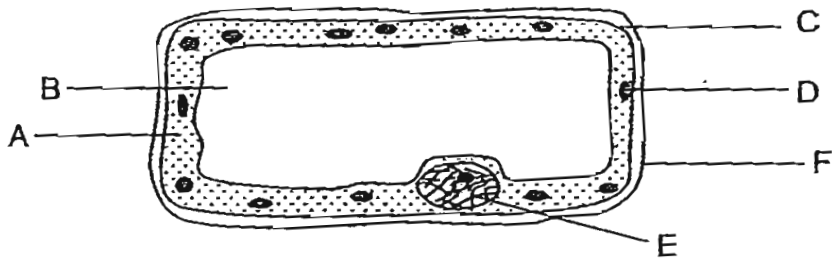

Which one of the following identifies the parts of the cell correctly?

	where light energy is trapped	controls the substance that enters and leaves the cell	can also be found in animal cells
(1)	X	F	A,C,F
(2)	X	C	B,D,E
(3)	D	C	A,C,E
(4)	D	X	B,E,F

2. Which of the following statements is/are true about bird's nest fern, bracket fungus and moss?

- ~~X~~ They bear flowers.
- ~~X~~ They need to grow in soil.
- ~~X~~ They reproduce from spores.
- ~~X~~ They are able to make their own food.

- ~~X~~ C only
- ~~X~~ A and B only
- ~~X~~ B and C only
- ~~X~~ A, C and D only

3. Kamariah cut a flower and drew the cross-section of the flower as shown below.

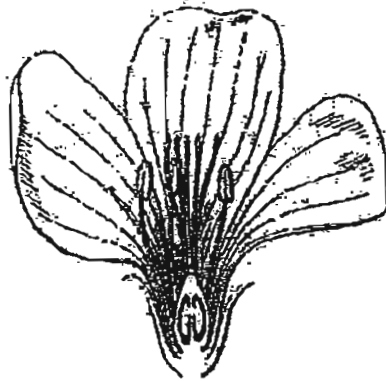

Based on her observations of the flower, she made some notes as shown below.

- A The flower has an ovary.
- B The flower has a sweet smell.
- C The anther is lower than the stigma.
- D The bright red petals of the flower are large.

Which of the following characteristics of the flower noted by Kamariah show that it is pollinated by animals?

- A and C only
- B and D only
- A, B and C only
- B, C and D only

4. Shi Qi studied some frogs in the school eco-pond.



Which one of the following statements is ~~not~~ true about the life cycle of a frog?

- (1) Frogs have a 3-stage life cycle.
- (2) Frogs lay many eggs at one time.
- (3) The eggs develop in the body of the female frog.
- (4) The young of the frog does not resemble the adult.

5. Study the flowchart below.

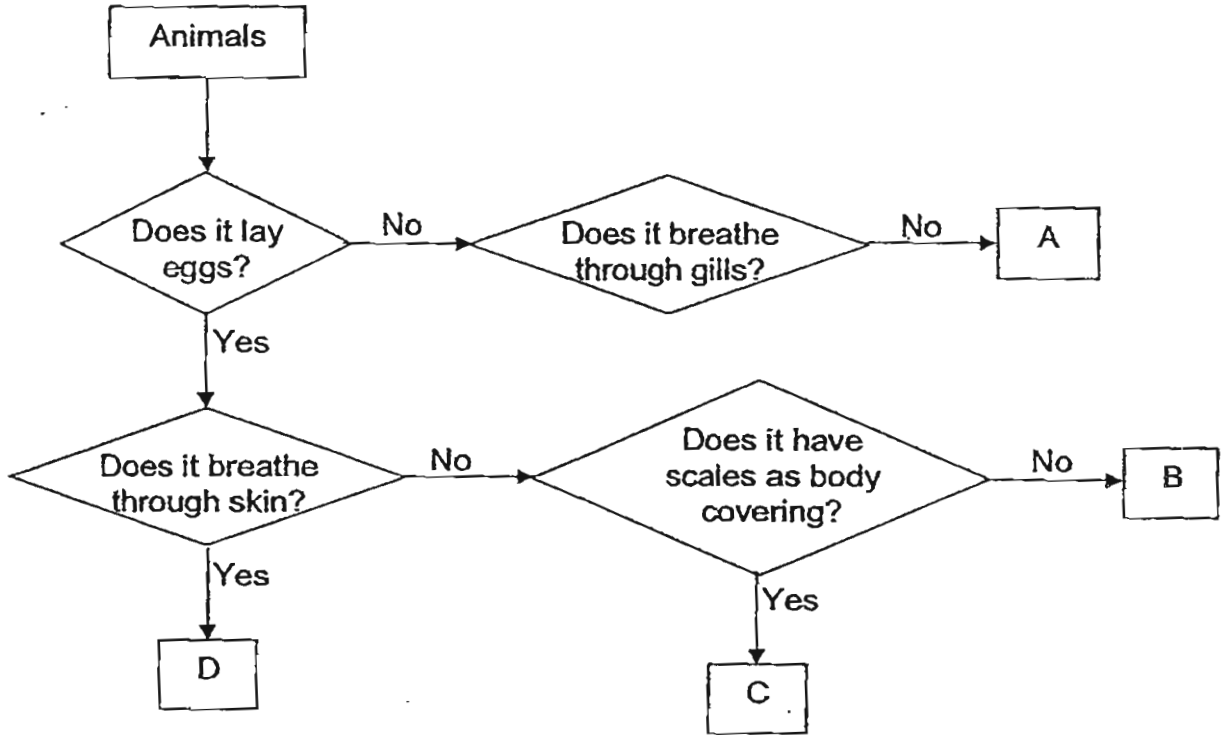

Which one of the following correctly represents the animals A, B, C and D?

	A	B	C	D
(1)	Whale	Ostrich	Frog	Platypus
(2)	Frog	Shark	Dolphin	Ostrich
(3)	Dolphin	Platypus	Goldfish	Frog
(4)	Platypus	Dolphin	Ostrich	Shark

6. Elizabeth wanted to investigate how her pulse rate changes with different activities. She jumped on a trampoline for 10 minutes, rested in a standing position for 10 minutes and then sat on a sofa to read a book for another 10 minutes.

Which one of the graphs below shows her pulse rate over the 30 minutes?

(1)

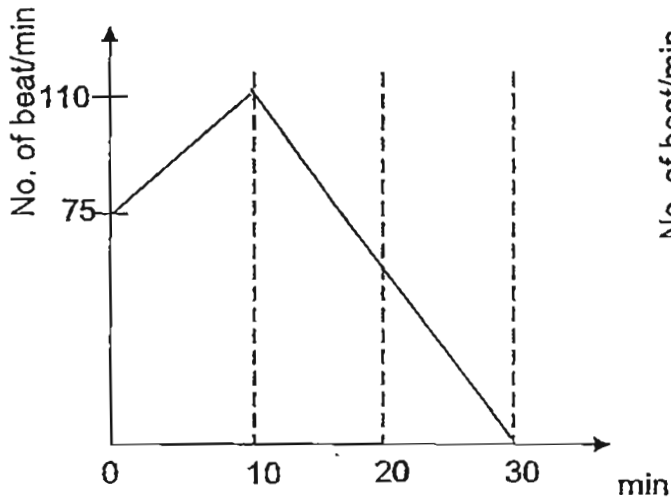

(2)

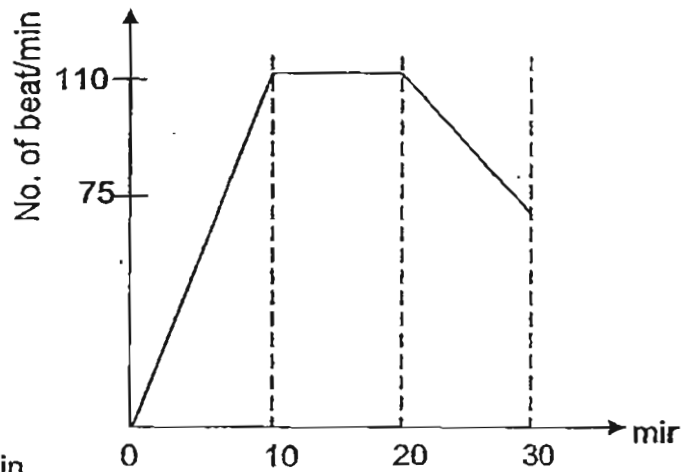

(3)

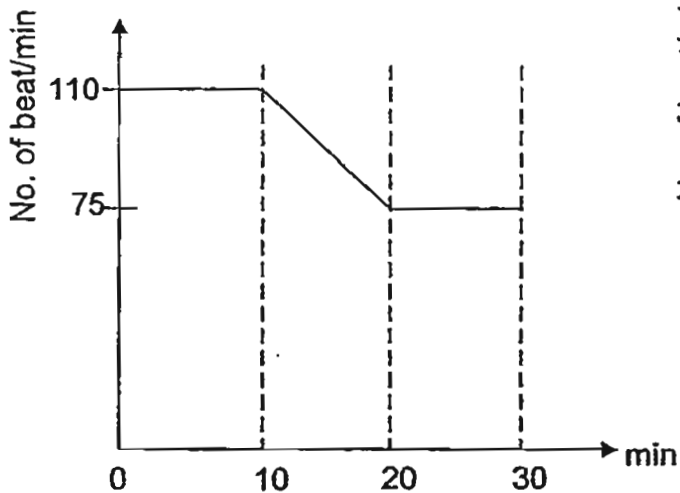

(4)

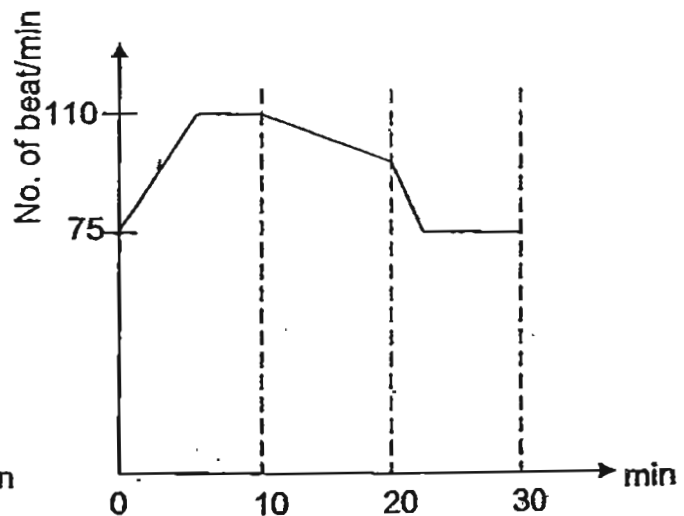

7. Mrs Chin wanted to convince her students that plants take in water through their roots. Which one of the following set-ups should she use for her classroom demonstration?

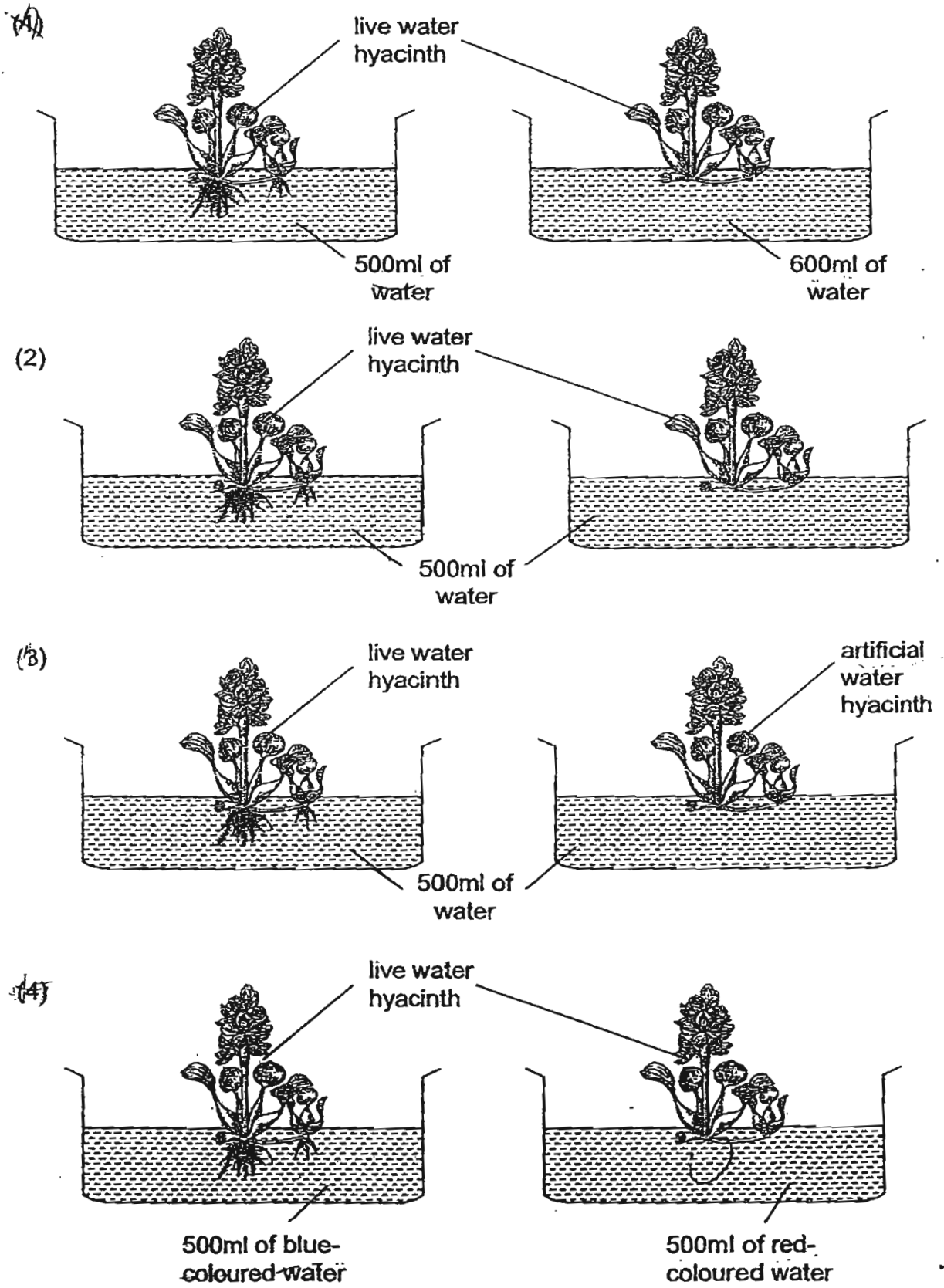

8. Figure 1 shows the location of 2 parent plants before they disperse their fruits while Figure 2 shows the location of their seedlings a few months later.

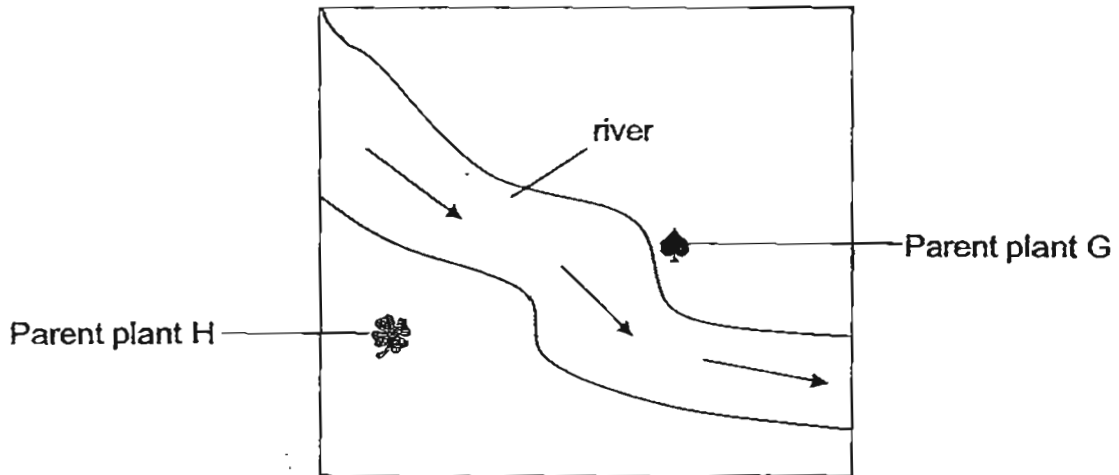
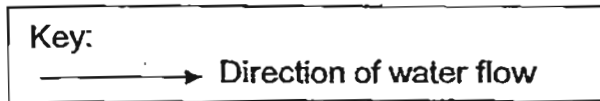

Figure 1

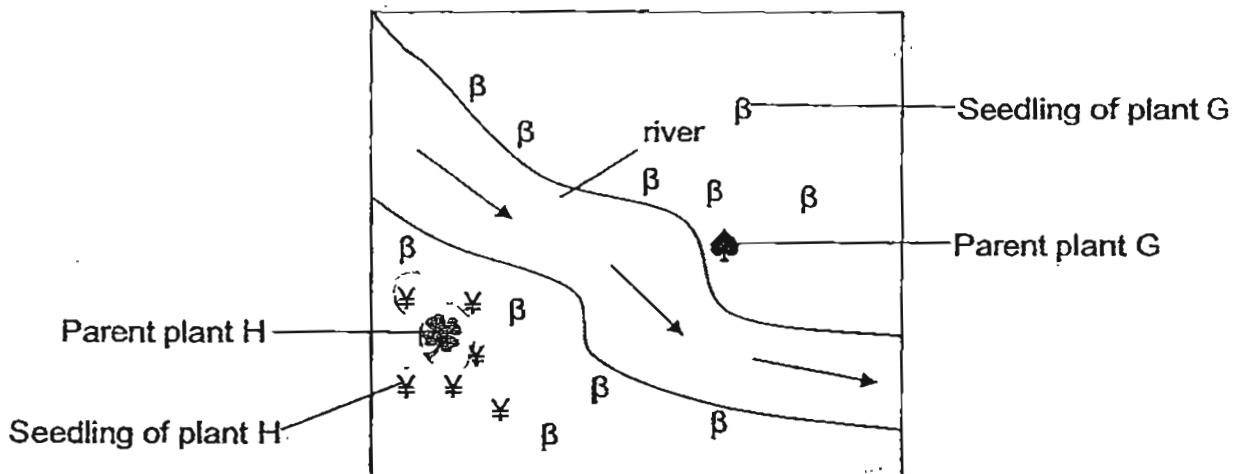

Figure 2

Which one of the following correctly represents plants G and H?

	Plant G	Plant H
(1)	Balsam	Pong Pong
(2)	Rambutan	Shorea
(3)	Coconut	Angsana
(4)	Papaya	Balsam

9. The diagram below shows two cats.



black fur
green eyes
short tail



white fur
blue eyes
long tail

Which one of the following kittens shown below could possibly be the young of the two cats?

(1)

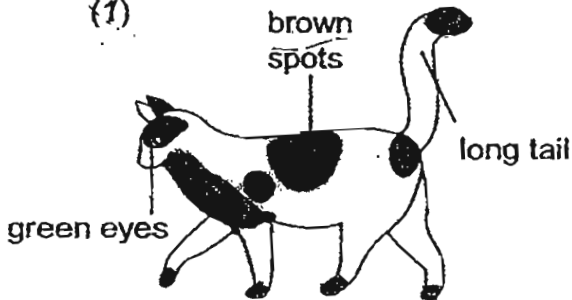

(2)

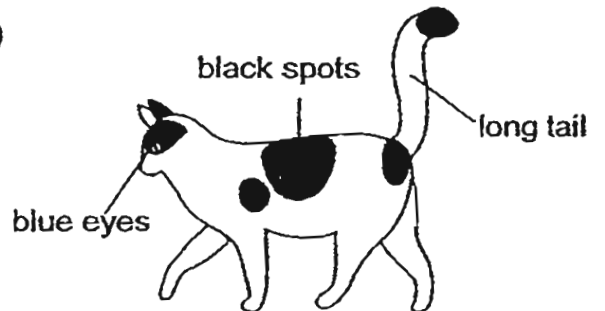

(3)

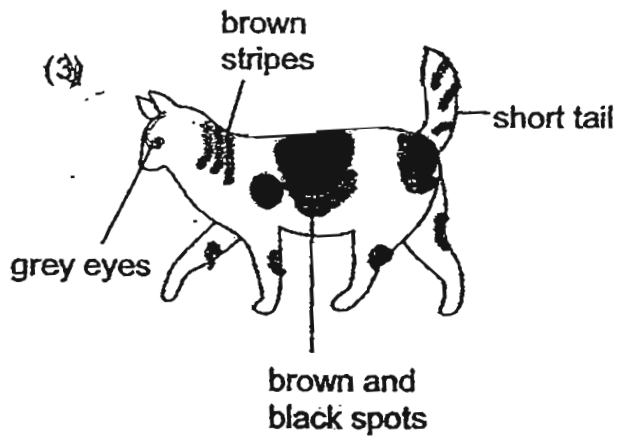

(4)

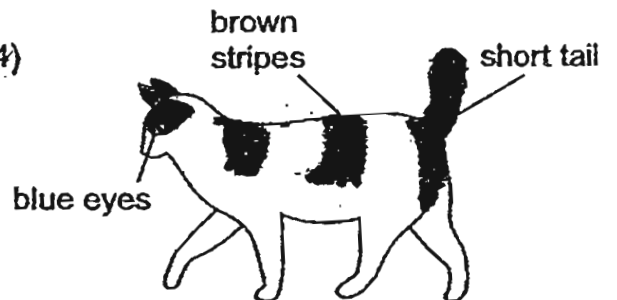

10. The diagram below shows an onion.



Which one of the following diagrams shows a cell taken from the plant part above?

(1)



(2)

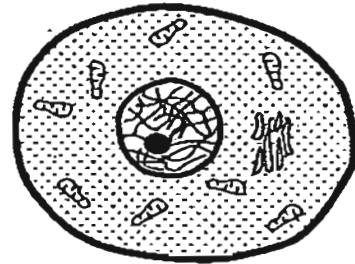

(3)



(4)

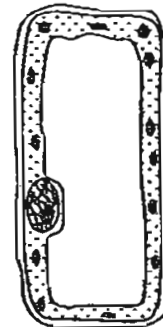

11. The diagram below shows the cross-section of a stem. The parts labelled X and Y carry out certain functions for the plant.

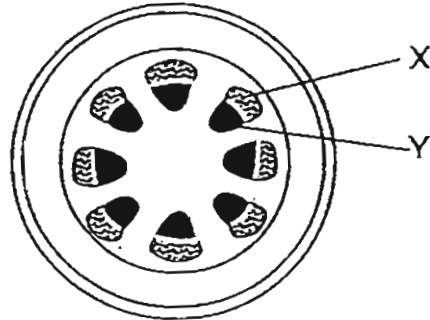

Which one of the following shows the functions of parts X and Y correctly?

	Function	
	Part X	Part Y
(1)	Transport water	Transport food
(2)	Control the amount of food make by the plant	Control the materials going in and out of the stem
(3)	Transport food	Transport water and mineral salts
(4)	Transport food and oxygen	Transport water and carbon dioxide

12. Soon Qi carried out an experiment to find out if light from a brightly lit lamp could affect the germination of seeds of plant Q.

She placed seeds of plant Q in set-up 1 as shown below.

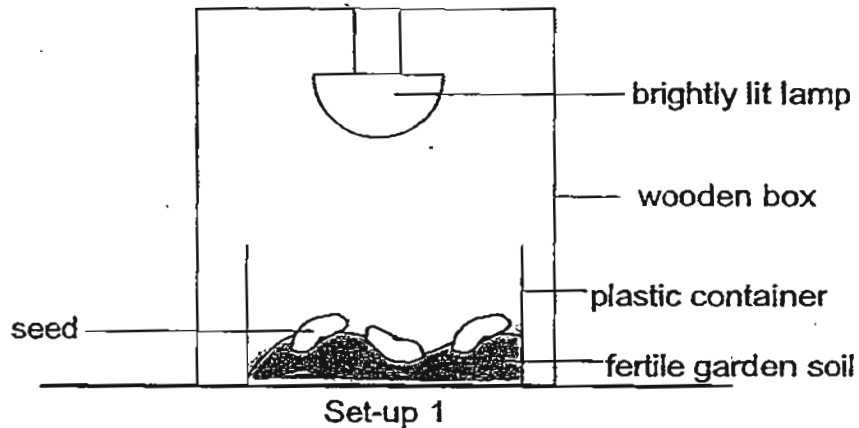

Which one of the following set-ups is most suitable for Soon Qi to use as a control for her experiment?

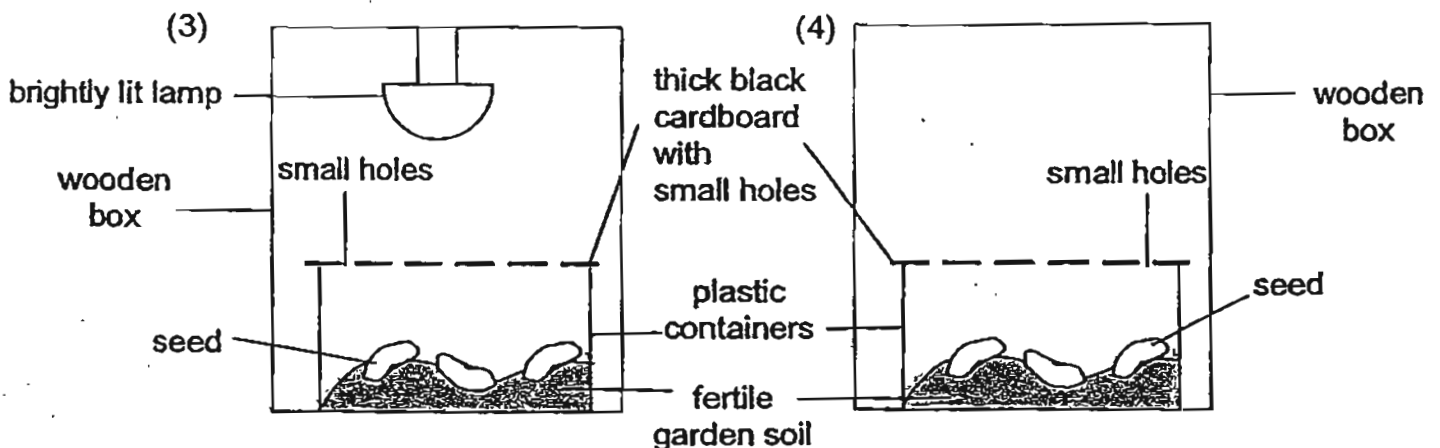
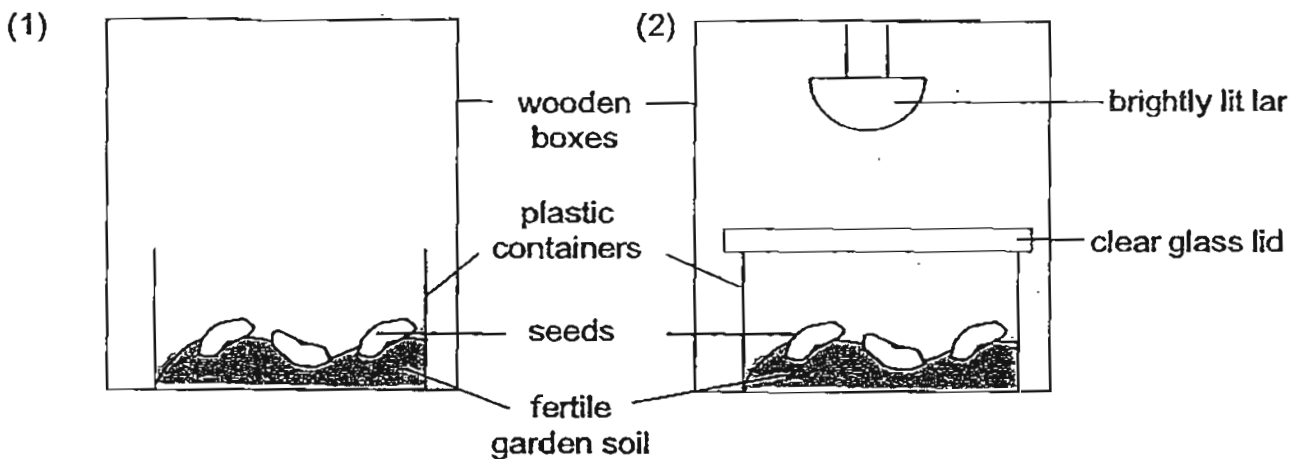

13. The diagram below shows the family tree of Anna, Catherine and Brian.

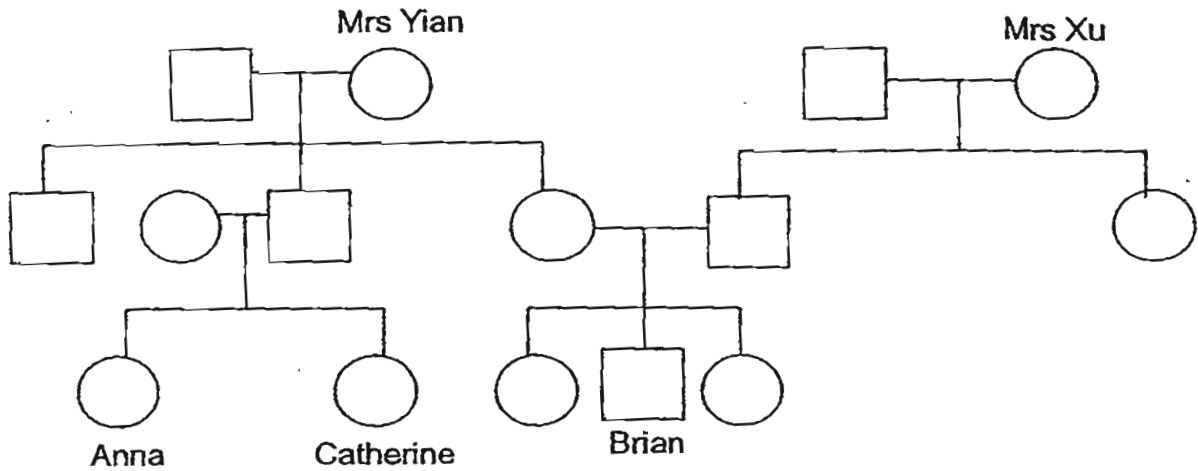

Based on the information above, which of the following statements is/ are correct?

- A Catherine has a sister.
- ~~B~~ Anna and Catherine are twins.
- ~~C~~ Brian's mother has 4 nieces.
- D Anna and Brian's mothers are sisters.

- ~~(1)~~ A only
- (2) A and D only
- ~~(3)~~ B and C only
- ~~(4)~~ C and D only

14. The diagrams below show the reproductive organs of a human.

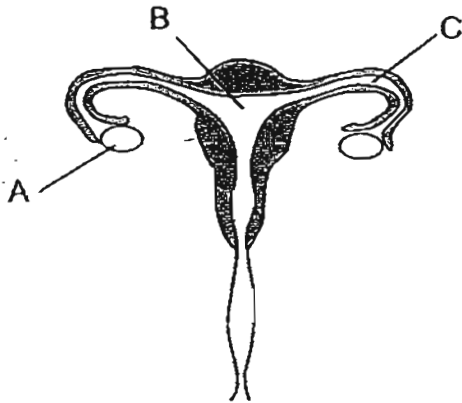

Female reproductive organ

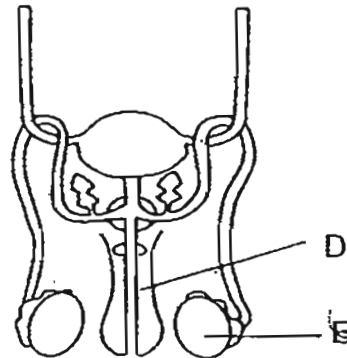

Male reproductive organ

Which one of the following shows the correct functions of the male and female reproductive organs?

	Female reproductive sex cell is produced	Male reproductive sex cell is produced
(1)	A	E
(2)	B	D
(3)	A	D
(4)	C	E

15. The diagram below shows a process occurring in the reproduction of an organism.

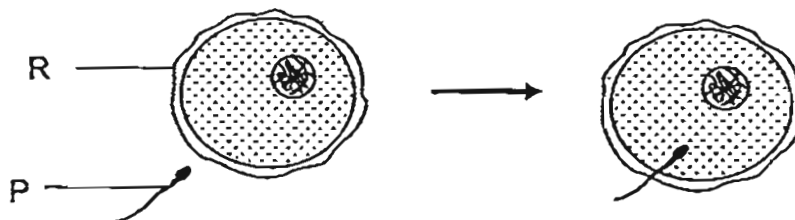

Which one of the following statements is **not** true?

- (1) Many organisms P are released at one time.
- (2) The process can only occur inside the female's body.
- (3) Usually, only one organism R is released at one time.
- (4) Usually, only one organism P can fuse with organism R.

16. Vinood wanted to find out if thin sheets of different materials would allow magnetism to pass through and attract the needle. He set up the experiment as shown below.

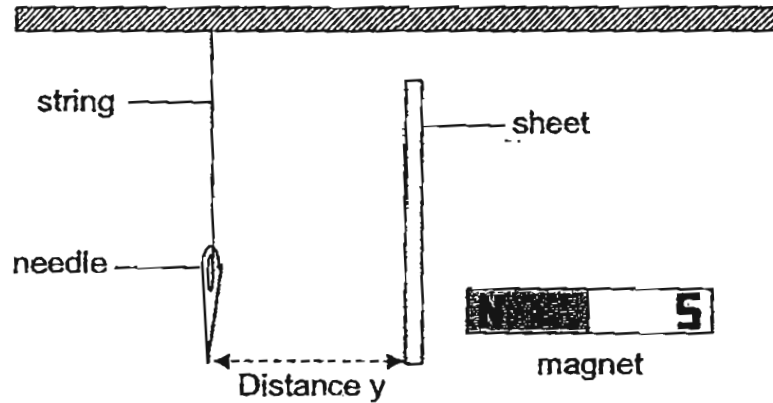

Which one of the following tables shows the correct variables that he should change and those that he should keep constant while conducting the experiment?

(1)

Variables	Keep constant	Change
Length of string	✓	
Distance y		✓
Thickness of sheet	✓	
Material of sheet	✓	

(2)

Variables	Keep constant	Change
Length of string	✓	
Distance y	✓	
Thickness of sheet	✓	
Material of sheet		✓

(3)

Variables	Keep constant	Change
Length of string	✓	
Distance y	✓	
Thickness of sheet		✓
Material of sheet	✓	

(4)

Variables	Keep constant	Change
Length of string	✓	
Distance y	✓	
Thickness of sheet		✓
Material of sheet		✓

17. Henry learnt in school that certain rods can be made into temporary magnets by stroking them with a magnet. He wanted to find out if the number of strokes he made with the magnet would affect the number of paper clips the rod can attract.

He stroked a rod with a magnet as shown below.

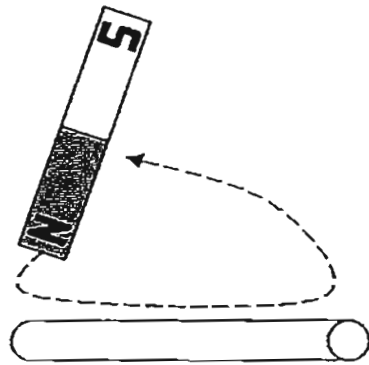

Which one of the following rods can attract the most number of paper clips?

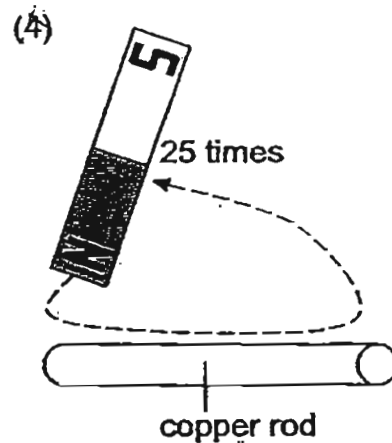
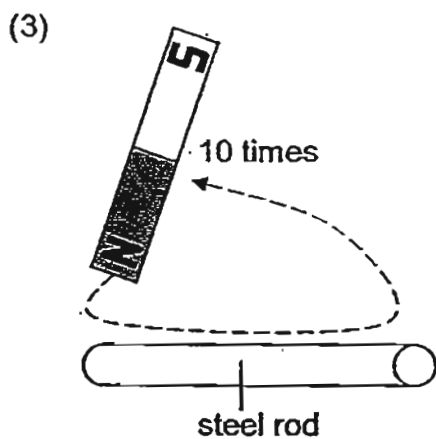
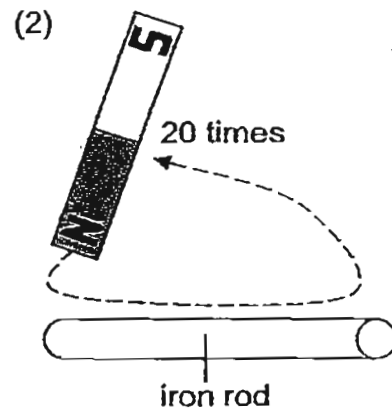
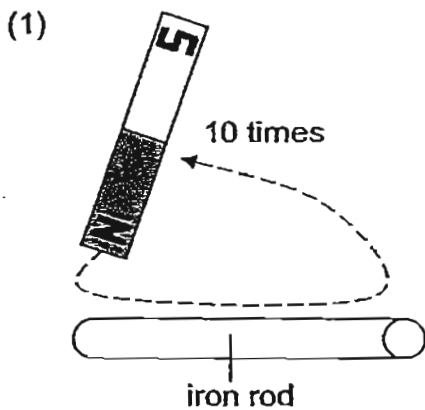

18. Which of the following descriptions of heat exchange are correctly matched to the change in the state of water?

	Change of state	Heat exchange
A	Gas → liquid	Heat is gained
B	Liquid → gas	Heat is gained
C	Liquid → solid	Heat is lost
D	Solid → liquid	Heat is lost

- ~~(1)~~ A and B only
~~(2)~~ B and C only
~~(3)~~ B and D only
~~(4)~~ C and D only

19. A group of students is discussing the possible ways to conserve water. The following are some of their suggestions.

- A Let the tap run while brushing our teeth.
B Take frequent showers to cool yourself.
C Reuse the water from washing vegetables to flush the toilet.
D Use water from a watering can instead of a hose to water the plants.

Which of the above suggestions can help to conserve water?

- ~~(1)~~ B only
~~(2)~~ C only
~~(3)~~ A and B only
~~(4)~~ C and D only

20. Shakira set up a circuit as shown below.

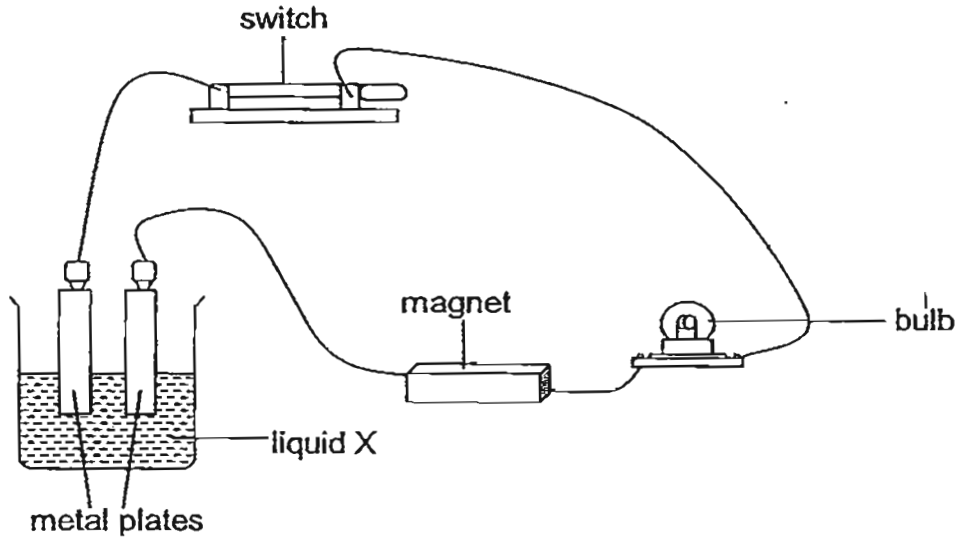

When the switch was closed, the bulb did not light up.
Which one of the following statements is definitely true about the circuit above?

- (1) The bulb has fused.
- (2) There is no power source.
- (3) Liquid X is not a conductor of electricity.
- (4) The metal plates are non-conductors of electricity.

21. Sze Yui soaked 4 handkerchiefs, W, X, Y and Z, with the same amount of water. They were made from the same material and of equal thickness. She folded each handkerchief and hung them on a bamboo pole which was placed under the hot sun. She recorded the time taken for each handkerchief to dry in the table below.

Handkerchief	Number of folds	Time taken for handkerchief to dry
W	0	8 mins
X	1	13 mins
Y	2	20mins
Z	3	25 mins

Which one of the following conclusions is true?

- (1) Handkerchief Z has a bigger exposed surface area than handkerchief W.
 (2) Handkerchief X has a smaller exposed surface area than handkerchief Y.
 (3) The number of folds has no effect on the rate that the handkerchiefs dry up.
 (4) The exposed surface area of the handkerchief affects the rate of evaporation.
22. The diagram below shows box L and box M. Box L contains matter X and box M contains matter Y. Both boxes are of different sizes and they balance each other on a weighing scale as shown below.

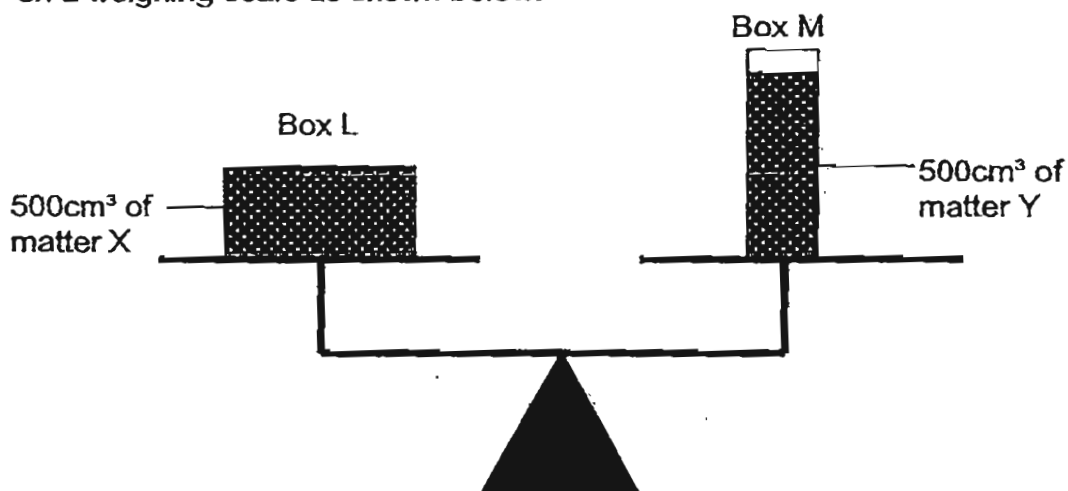

Which of the following statements is/are definitely true?

- (A) Matter X and Y have the same mass.
 (B) Matter X and Y have the same volume.
 (C) Matter X is a gas while Matter Y is a liquid.
 (D) Boxes L and M are made of the same material.
- (1) B only
 (2) A and B only
 (3) C and D only
 (4) B, C and D only

23. Mages carried out an investigation on the property of air using three identical plastic cups, A, B and C, and a basin of water. Holes were made in cups B and C as shown in the diagram below. The cups were pushed vertically downwards into the basin of water.

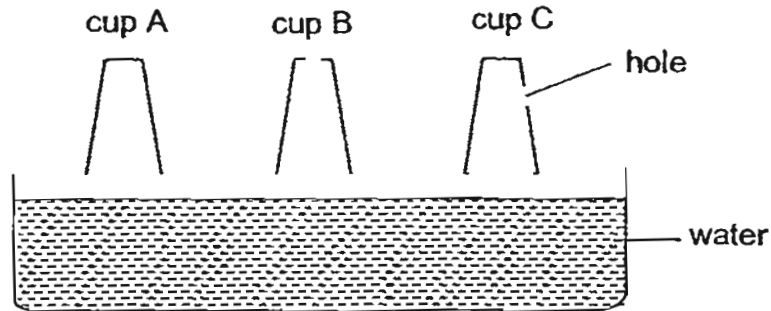

Which one of the following shows the correct water levels in cups A, B and C?

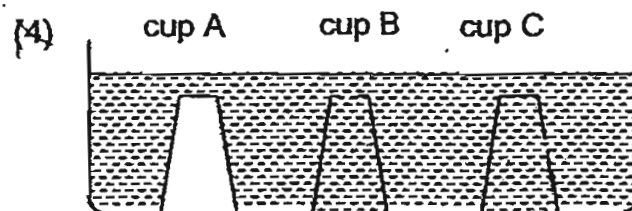
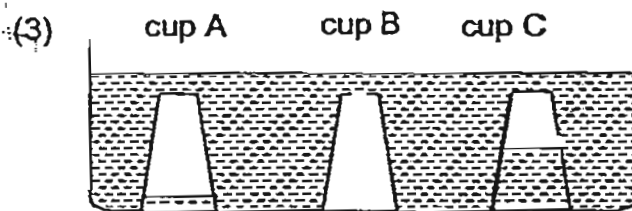
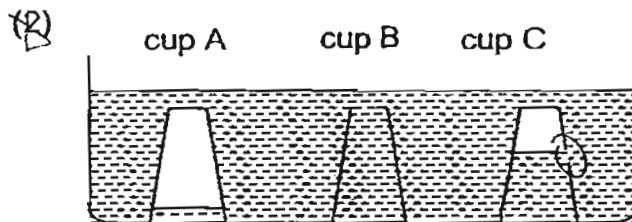
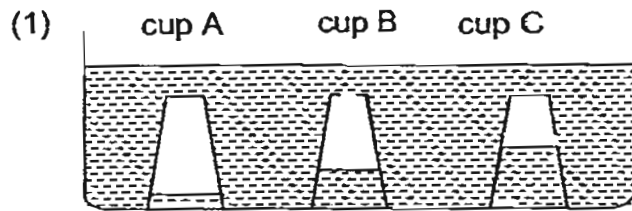

24. The batteries and bulbs used in the circuits below are identical.

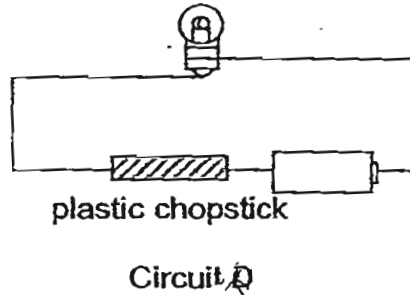
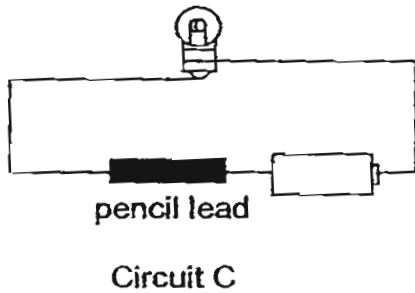
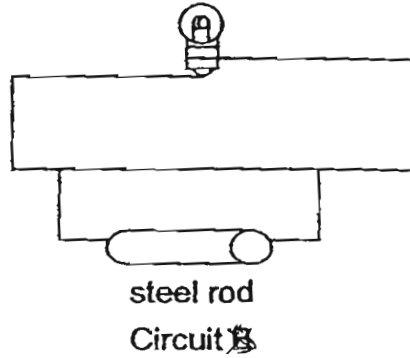
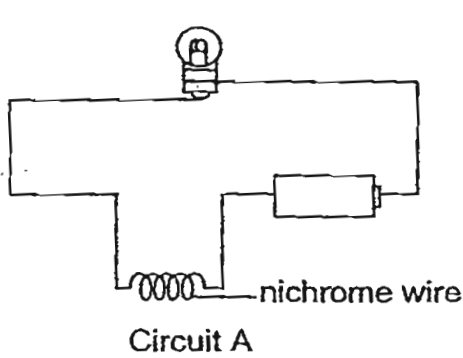

In which of the above circuits do the bulbs light up?

- (1) A and C only
- (2) B and D only
- (3) A, C and D only
- (4) A, B, C and D

25. The graph below shows the change in temperature of a beaker of water over a period of time. Which part of the graph indicates heat loss by the water?

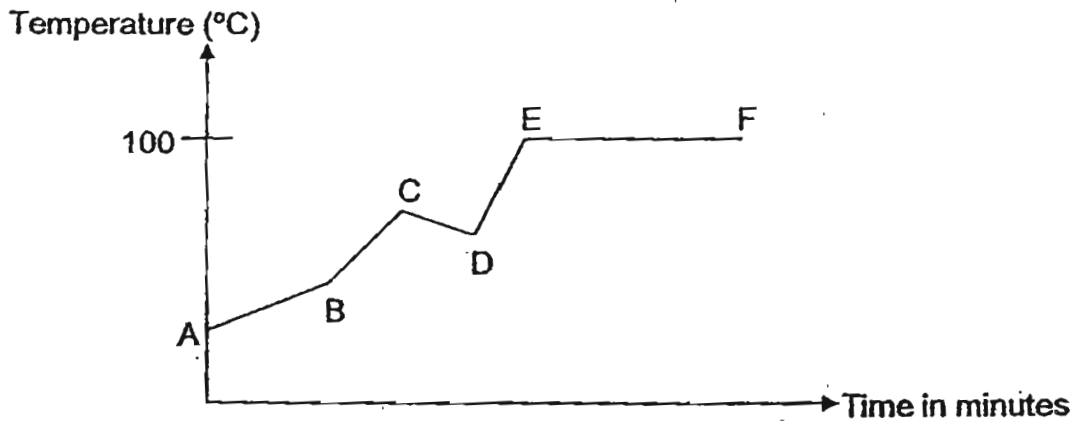

- (1) AB
- (2) BC
- (3) CD
- (4) EF

26. Susan dropped a ball that glowed in the dark into a drain. She wanted to retrieve the ball but she could not see from where she was kneeling down at position S.

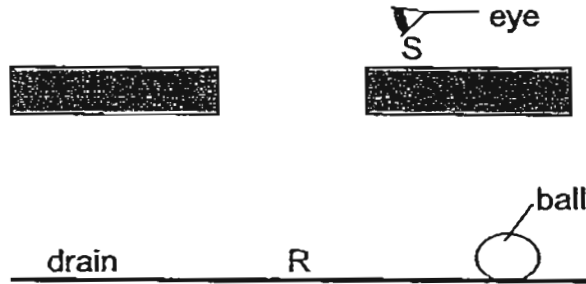

Key:

reflective side of mirror

mirror

If a mirror was lowered into the drain and placed at position R, at which angle should the mirror be placed so that Susan could see the ball in the drain clearly?

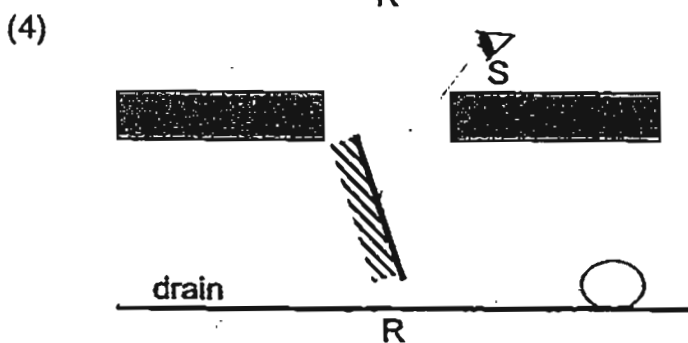
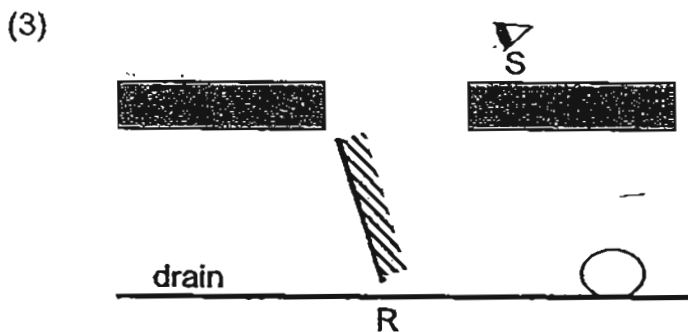
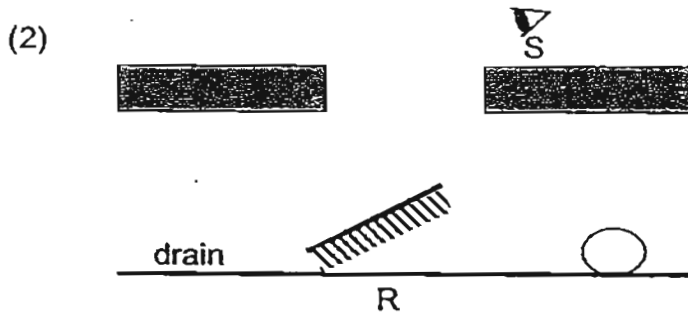

27. Study the flowchart below.

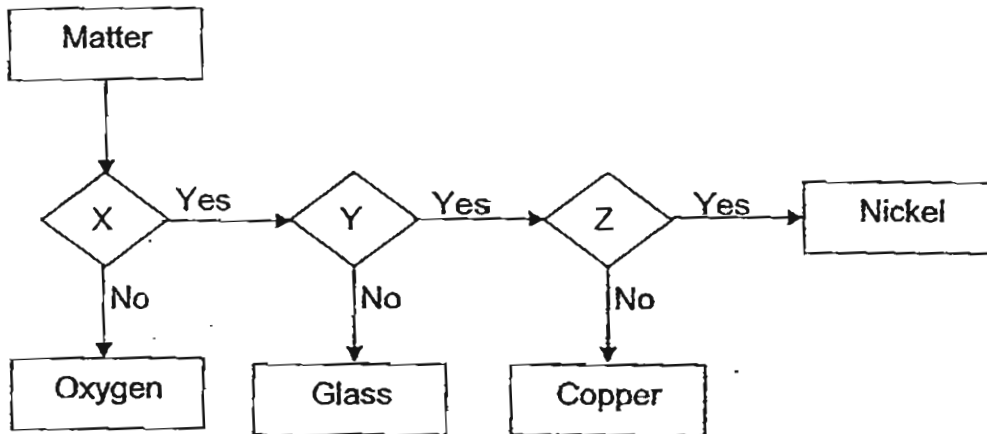

Which one of the following sets of questions can be represented by X, Y and Z?

	X	Y	Z
(1)	Does it conduct electricity?	Is it magnetic?	Is it a solid?
(2)	Is it a solid?	Does it conduct electricity?	Is it magnetic?
(3)	Is it magnetic?	Does it conduct electricity?	Is it a solid?
(4)	Is it magnetic?	Is it a solid?	Does it conduct electricity?

28. Five light bulbs are placed at different positions in the circuit shown below. All the bulbs are in working condition and A, B, C and D are switches.

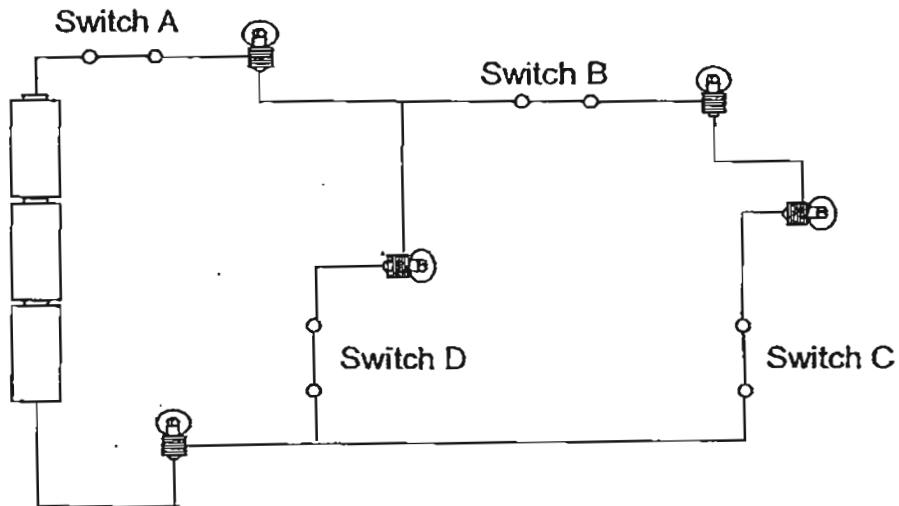

Which one of the following statements is **not** true when certain switches stated are open?

- (1) When switch D is open, only 4 bulbs would light up.
- (2) When switch B is open, only 3 bulbs would light up.
- ~~(3)~~ When switch C is open, only 4 bulbs would light up.
- (4) When switch A is open, none of the bulbs would light up.

29. Falisya shone a torch at a tennis ball and a rectangular piece of blue cellophane paper as shown below. A shadow was cast on the screen.

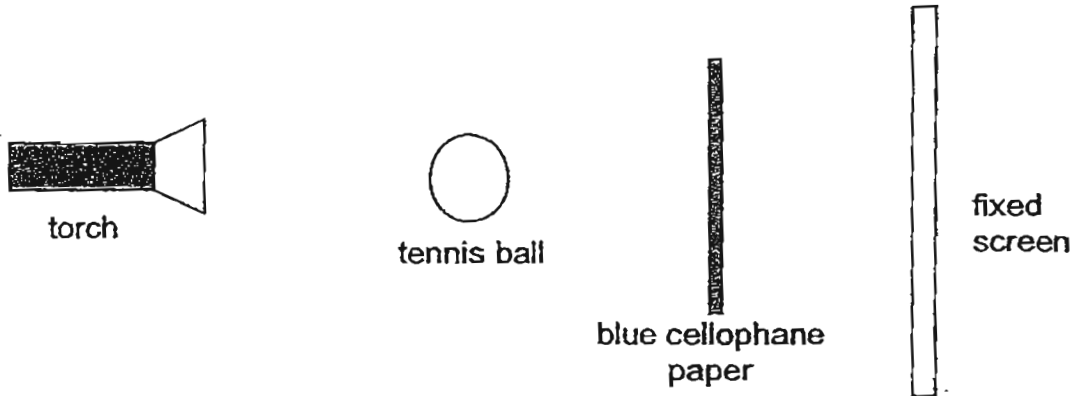

Which one of the following shadows was cast on the screen?

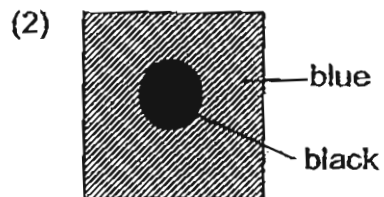
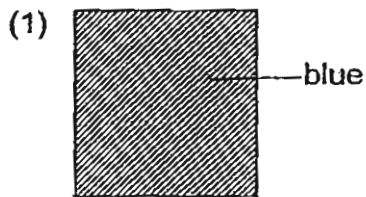

30. Jessica filled a beaker with 500ml of water. She then poured all the water into a cylinder as shown in the diagram below.

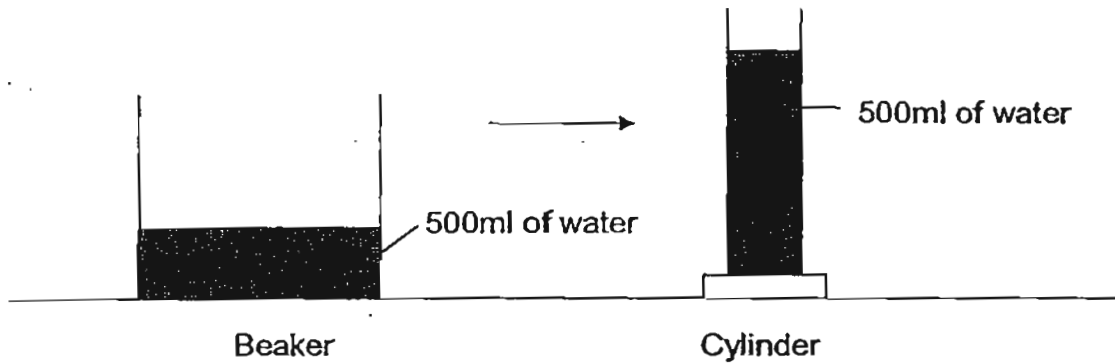

Which of the following changes would she observe after she had poured all the water into the cylinder?

- ~~A~~ Amount of water increased.
- ~~B~~ Mass of the water increased.
- ~~C~~ State of the water changed.
- D Height of the water increased.
- ~~E~~ Temperature of water increased.

- ~~(1)~~ D only
- (2) A and E only
- ~~(3)~~ A, B and D only
- (4) B, C, D and E only

--- End of Section A ---

Name: _____ ()

Class: Primary 5 _____

CHIJ ST NICHOLAS GIRLS' SCHOOL



Primary 5

Semestral Assessment 2– 2011

SCIENCE

BOOKLET B

2nd November 2011

Total Time for Booklets A and B: 1 hour 45 minutes

14 questions
40 marks

Do not open this booklet until you are told to do so.
Follow all instructions carefully.
Answer all questions.
Write your answers in this booklet.

This paper consists of 15 printed pages.

Booklet A	60
Booklet B	40
Total	100

Parent's Signature/Date

Section B: 40 marks

For questions 31 to 44, write your answers in this booklet.

The number of marks available is shown in the brackets [] at the end of each question or part question.

31. A thin plastic tube containing starch solution is placed in a basin of iodine solution and left aside for a few days as shown below.

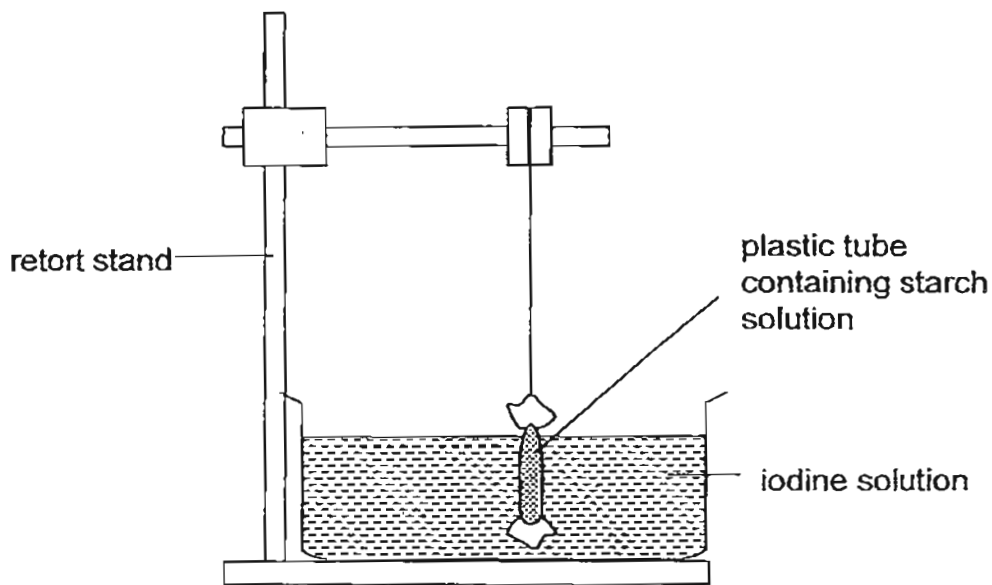

- (a) What could be observed in the plastic tube after a few days? [1]

- (b) Explain your answer in (a). [1]

- (c) Which part of the animal cell does the plastic tube represent? [1]



32. The table below shows some characteristics that Joan and her family members possess.

Joan's family member	Characteristics		
	Eye colour	Tongue rolling	Hair length
Grandfather	Black	Able	Short
Grandmother	Brown	Unable	Long
Father	Brown	Unable	Short
Mother	Brown	Unable	Short
Sister	Black	Unable	Long
Joan	Brown	Able	Short

- (a) Based on the information above, which characteristic is not a trait? [1]

- (b) What is a characteristic that Joan has that her parents do not? [1]

- (c) Explain how Joan is able to have the characteristic in (b). [1]



33. Elena wanted to find out if leaves can give out water. She prepared a set-up as shown below and placed it near a window.

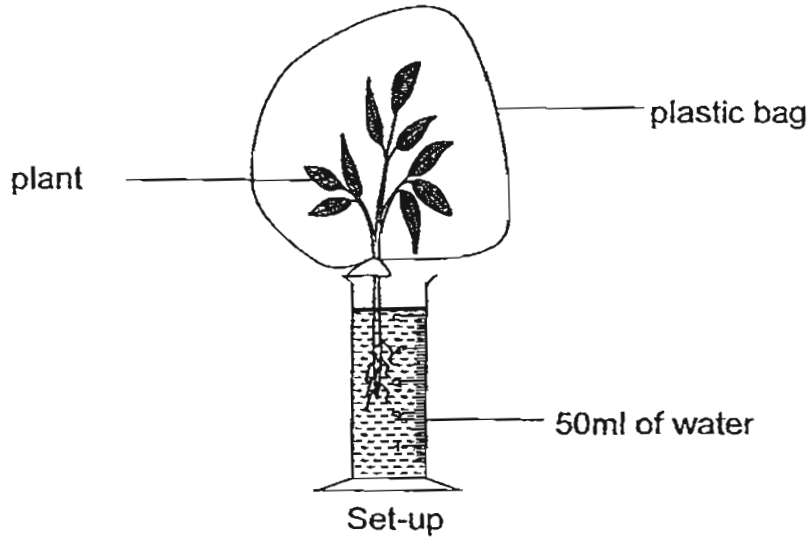

- (a) Elena's teacher told her that she would need a control for her experiment. Tick the variables she must have in the control set-up in order to conduct a fair test. [2]

Variables for control set-up	
Plastic bag	
50ml of water	
Plant without roots	
Plant without leaves	
Measuring cylinder	

- (b) What could Elena observe in the above set-up in a few hours? [1]

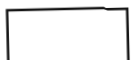

34. The diagram below shows the circulatory system of a human.

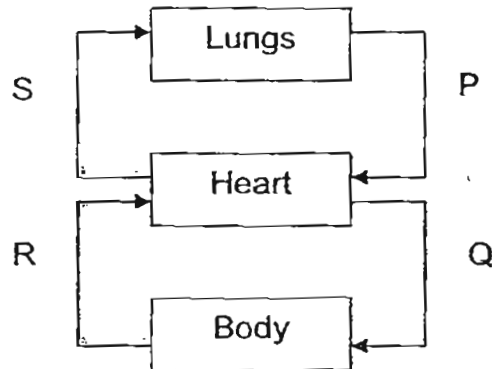

(a) Write down the letters, P, Q, R and S, in the correct boxes below. [2]

Blood rich in carbon dioxide	Blood poor in carbon dioxide

(b) The diagram below shows the circulatory system of a fish.

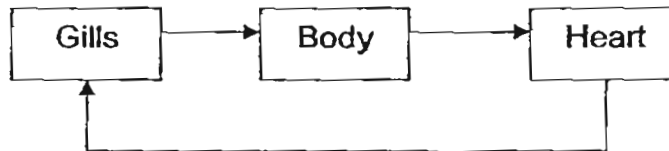

(i) From the two diagrams above, state one similarity between the circulatory system of a human and a fish. [1]

(ii) Compare the transportation of oxygen to the body parts in the two systems above. [1]



35. Melissa wanted to investigate the effect the colour of flowers had on the number of bees visiting it. She made flowers of the same size using similar type of paper of different colours. In the middle of each flower, she attached a ball of cloth coated with 10ml of honey.

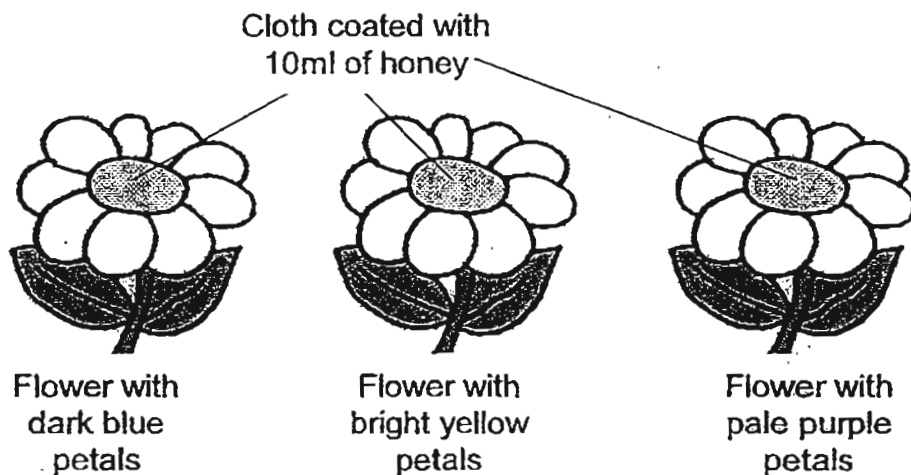

Melissa placed the 3 flowers in a garden and counted the number of bees that landed on each flower over 4 hours.

- (a) State one other variable that Melissa must keep unchanged throughout the experiment. [1]
-

Melissa recorded her observations in the table below.

Colour of flower	Number of bees that landed on the flowers			
	1 st hour	2 nd hour	3 rd hour	4 th hour
Dark blue	3	4	4	3
Bright yellow	8	10	9	8
Pale purple	5	3	3	4

- (b) What could Melissa conclude from the results of her experiment? [1]
-

- (c) Why did she carry out her experiment over four hours? [1]
-



36. The diagram below shows two shorea fruits, P and Q. Some parts of fruit Q have been cut off.

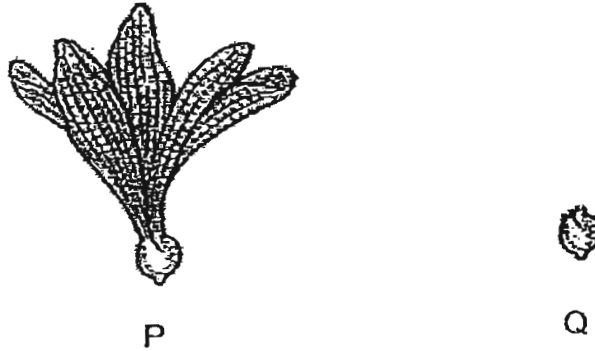

The two shorea fruits were dropped from the same height and the time they took to land on the ground was recorded. The table below shows two sets of readings from the experiment.

	Time taken for the fruit to land on the ground		
	1 st try	2 nd try	3 rd try
Set 1	2.3s	2.1s	2.2s
Set 2	5.5s	6.5s	6.0s

- (a) What was the aim of the experiment? [1]

- (b) Based on the information from the table above, which set of readings was recorded when fruit P was released? [1]

- (c) Suggest a reason for your answer in (b). [1]



37. The picture below shows two fruits, a kiwi and a mango.



kiwi



mango

- (a) State the difference between the kiwi and the mango in terms of their methods of seed dispersal. [1]

- (b) Which of the two fruits has a higher chance of reproduction? Explain your answer. [1]

38. Mrs Lee placed a bottle of hot milk into a basin of cold water at 10°C as shown below. She left the bottle of milk in the basin for 10 minutes. The milk reached the room temperature after 8 minutes.

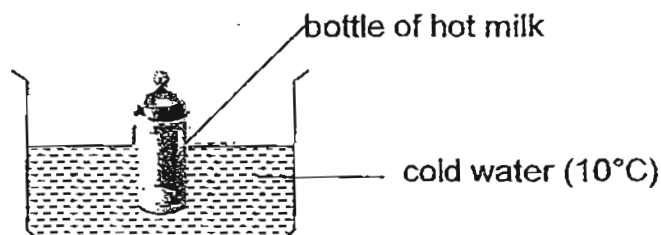

She plotted a graph below to show the changes in the temperature of the bottle of hot milk.

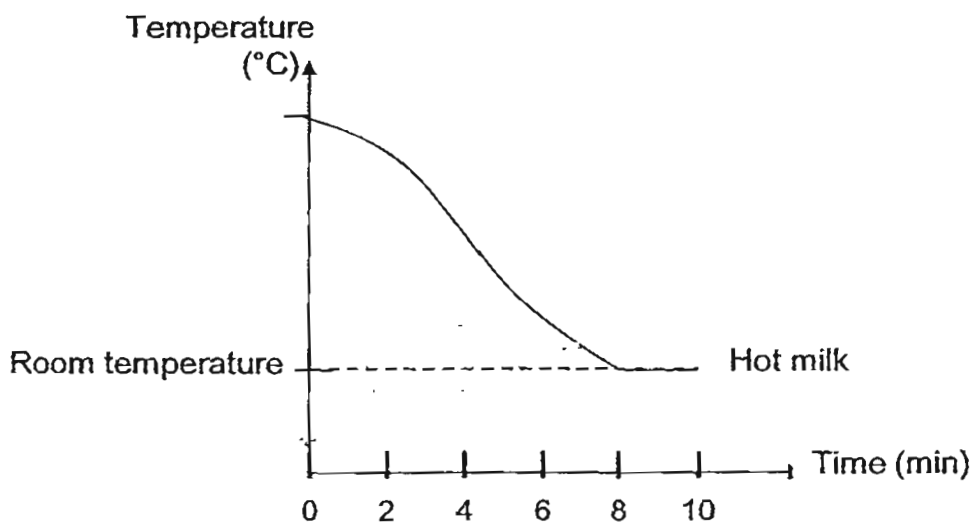

- (a) Draw on the graph above to show the change in temperature of the cold water in the basin. [1]
- (b) Explain your graph in (a) above. [1]



39. A glass bottle on a tripod stand was heated for 10 minutes as shown in the diagram below.

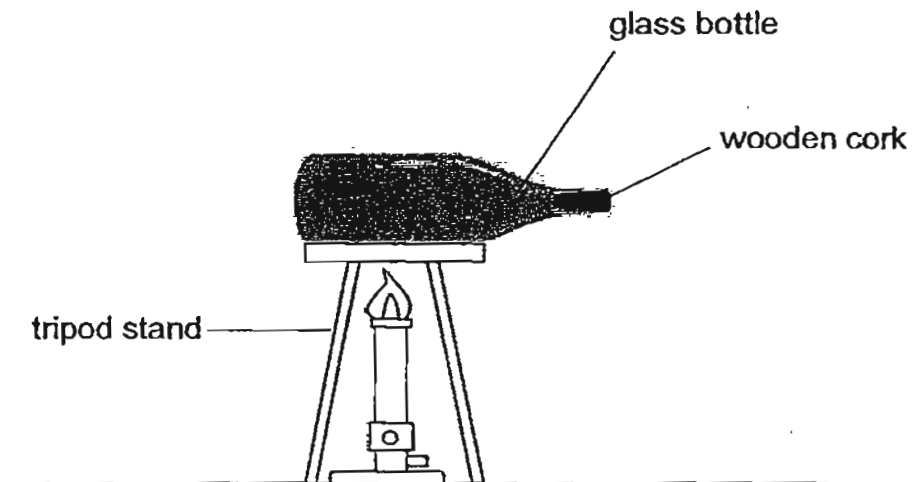

- (a) What would happen to the wooden cork after 10 minutes? [1]

- (b) Explain your answer in (a). [1]



40. Su Ling wanted to find out if the presence of wind and sunlight would affect the rate of evaporation. She weighed the mass of 4 pieces of identical cloth, A, B, C and D, that were soaked in equal amounts of water at the beginning and again at the end of the experiment. The table below shows the conditions at which the cloths were placed.

Cloth	Condition
A	Windy and under a coconut tree
B	Windy and under the sun
C	No wind and in the room
D	Light breeze and under a mango tree

- (a) Based on the information given above, arrange the mass of the cloths, A, B, C and D, at the end of the experiment starting from the heaviest to the lightest.

[1]

- (b) Su Ling opened all the doors and windows of the classroom after she had mopped the floor. Why did she open all the doors and windows of the classroom after mopping the floor?

[2]



41. Ashraf set up a circuit tester as shown below to test the electrical conductivity of four materials, W, X, Y and Z.

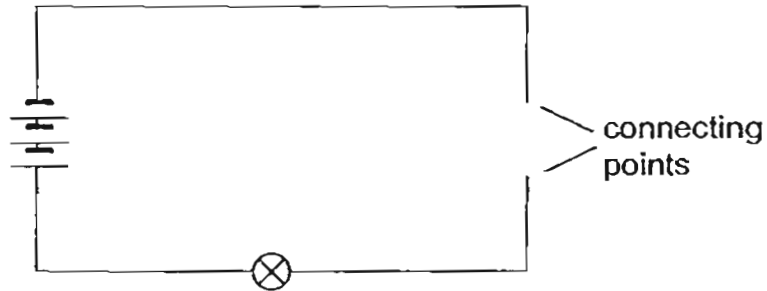

He placed each material, one at a time, across the connecting points and recorded his observations in the table below.

Material	W	X	Y	Z
Did the bulb light up?	Yes	No	No	Yes

- (a) Complete the classification chart below using the information given in the table above. Write suitable sub-headings and the letters, W, X, Y and Z in the boxes provided. [2]

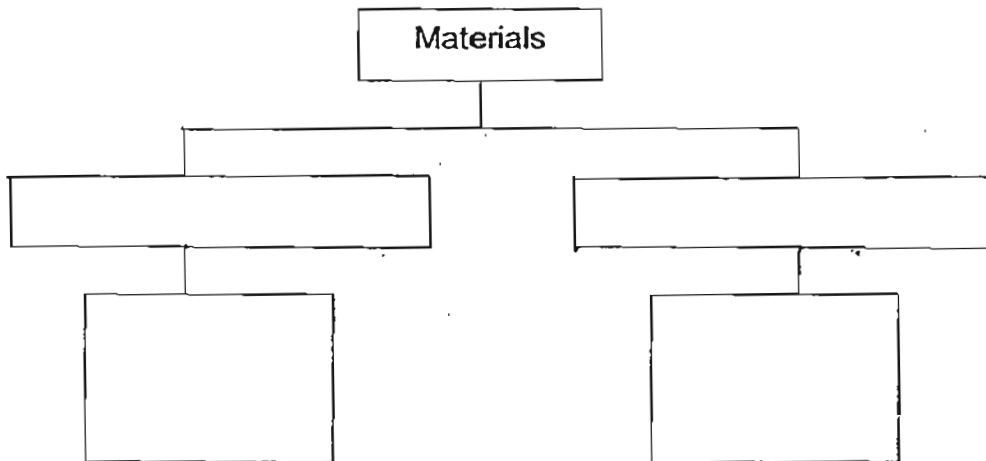

- (b) Ashraf then set up another circuit as shown below. He wanted to include a switch which would allow him to switch on or off one bulb only.

Mark with an 'X' on the circuit diagram below to show where he should place the switch. [1]

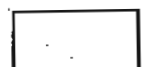
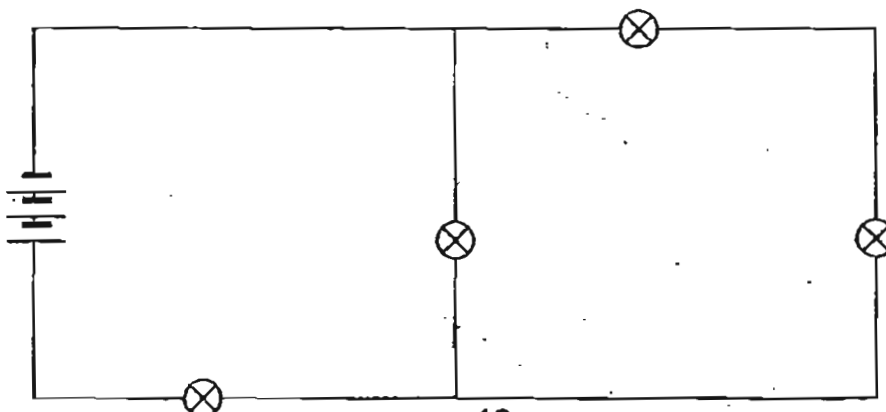

42. Alyssa took out a beaker full of ice cubes from the fridge and left them on the table for 10 minutes as shown below.

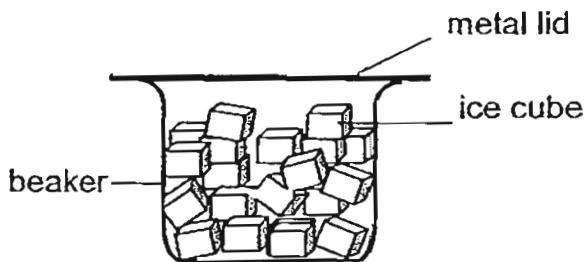

She noticed some water droplets on the set-up.

- (a) Draw on the diagram below to show where the water droplets could be found. [1]

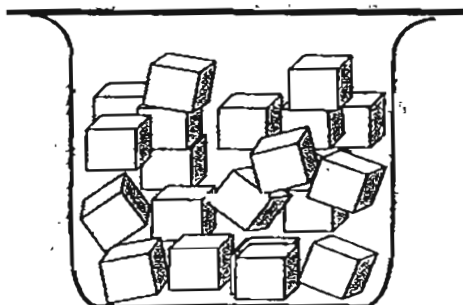

- (b) Explain clearly how the water droplets in (a) were formed. [2]



43. John carried out an experiment by heating three similar rods made of metals X, Y and Z for 10 minutes. He recorded the lengths of each rod before and after the heating in the table below.

Metal	Length before heating (mm)	Length after 10 min of heating (mm)
X	300	307
Y	300	305
Z	300	309

- (a) Based on the results of his experiment, what could John conclude about the effect of heating **different** metals? [1]

- (b) (i) In another experiment, John heated a thinner rod made of metal X of length 300 mm for 10 minutes.

Would the length of this rod after the heating be less than, equal to, or more than 307 mm? [1]

- (ii) Explain your answer in (b)(i) above. [2]



44. Kayla set up two circuits as shown below.

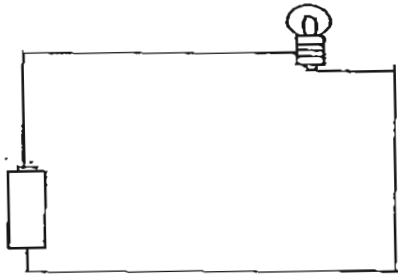

Circuit J

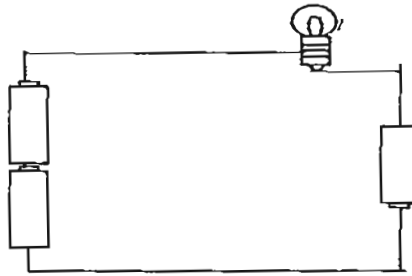

Circuit K

- (a) She noticed that the bulbs in the two circuits do not have equal brightness. Explain why this is so. [1]

- (b) Using the same bulb and the same number of batteries as in circuit K, redraw the circuit in the box below so that the bulb will have the same brightness as the bulb in circuit J when lit. [1]

--- End of paper ---



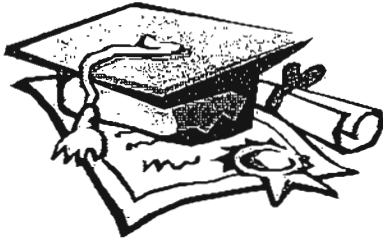

ANSWER SHEET

EXAM PAPER 2011

SCHOOL : CHIJ
SUBJECT : PRIMARY 5 SCIENCE
TERM : SA2

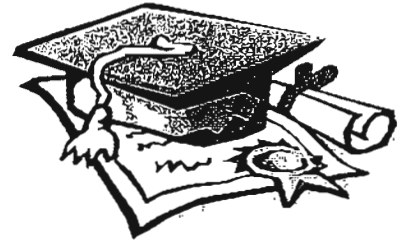

Q1	Q2	Q3	Q4	Q5	Q6	Q7	Q8	Q9	Q10	Q11	Q12	Q13	Q14	Q15	Q16	Q17
3	1	4	3	3	4	2	4	2	3	3	1	1	1	2	2	2

Q18	Q19	Q20	Q21	Q22	Q23	Q24	Q25	Q26	Q27	Q28	Q29	Q30
2	4	2	4	1	2	1	3	4	2	3	2	1

31)a)The iodine is the one that turns colour, not the starch.

b)The iodine solution has entered the plastic tube, with the starch solution, it turned blue.

c)Cell membrane.

32)a)hair length is not a trait.

b)Joan can roll her tongue but her parents cannot.

c)It is passed down to Joan by the hidden genes from her parents.

33)a) ✓

✓

✓

✗

b)Elena could observe water droplets on the inner surface of the plastic bag.

34)a)S,R P,Q

b)i)Both need a heart.

ii)For the fish, the oxygenated blood is directly connected to the body but for humans, it pumped to the heart first.

35)a)The size of the petals.

b)Bright petals attracts bees to it better than dark and pale petals.

c)To ensure her results are reliable.

36)a)The aim of the experiments is to find out wing-like structure affects the time taken for the fruit to land on the ground.

b)Set 2.

c)Fruit P has a wing-like structure, which allows it to stay afloat in the air longer, thus the time taken to reach the ground would be longer.

37)a)The Kiwi seeds are swallowed and passed out together with the waste of the animal while the mango seed is thrown away by the animal after the flesh is eaten.

b)Kiwi. It has more seeds than the mango, thus increasing the change of having more Kiwi seeds being dispersed.

38)a)

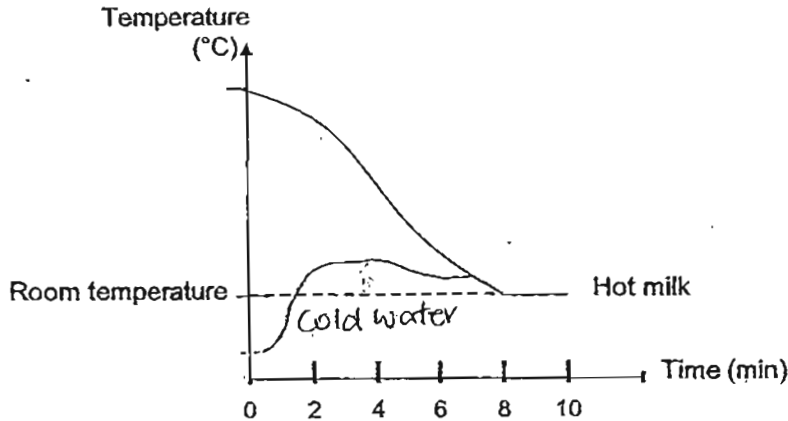

b)The cold water in the basin gained heat from the hot milk causing the temperature to increase and finally it reached room temperature.

39)a)The wooden cork will be pushed out of the bottle.

b)The glass bottle gained heat from the flame and expanded. In turn the air in the bottle gained heat and expanded causing the cork to be pushed out.

40)a)C, D, A, B

b)Su Ling wanted to make the water evaporate faster. Hence, she opened the door and windows to allow the wind to blow the water vapour away increasing the rate of evaporation. Also the sunlight could speed up the rate of evaporation.

41)a)Conductors Electricity

W, Z

Insulators of Electricity

X, Y

b)

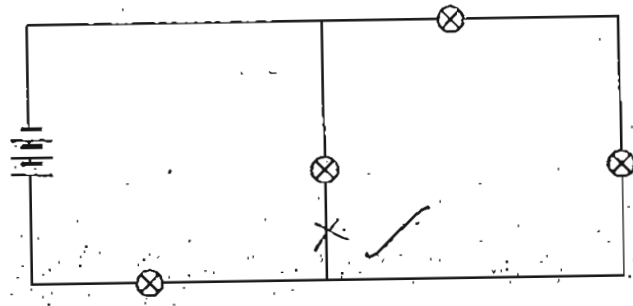

42)a)

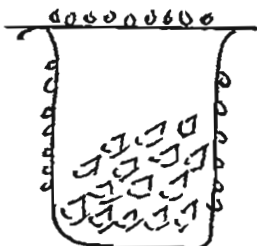

42)b)The ice cubes had cooled the surface of the beaker. Hence, the surrounding water vapour would be warmer than the cooler outer surface of the beaker. Thus, the water vapour lost heat to the cooler outer surface and condensed to form water droplets.

43)a)Different metals have different expansion rates.

b)i)It would be more than 307mm.

ii)The amount of heat supplied is the same. The thinner rod will take a shorter time to heat up as compared to the thicker rod. Hence, it will expand more.

44)a)There was only dry cell supplying electricity for circuit J whereas in K, there are 3 batteries producing electricity. Thus, it would be brighter than the bulb in J.

b)

