

NANYANG PRIMARY SCHOOL

PRIMARY 5 SCIENCE

**SECOND SEMESTRAL ASSESSMENT
2011**

BOOKLET A

Date : 2 NOVEMBER 2011

Duration : 1 h 45 min

Name : _____ ()

Class: Primary 5 ()

Marks Scored:

Booklet A:		60
Booklet B :		40
Total :		100

Parent's signature: _____

**DO NOT OPEN THIS BOOKLET UNTIL YOU ARE TOLD TO DO SO.
FOLLOW ALL INSTRUCTIONS CAREFULLY.**

Booklet A consists of 18 printed pages including this cover page.

Section A (30 x 2 marks = 60 marks)

For each question from 1 to 40, four options are given. One of them is the correct answer. Make your choice (1, 2, 3 or 4). Shade the correct oval (1, 2, 3 or 4) on the Optical Answer Sheet provided.

1. The diagram below shows the family tree of Heng Meng.

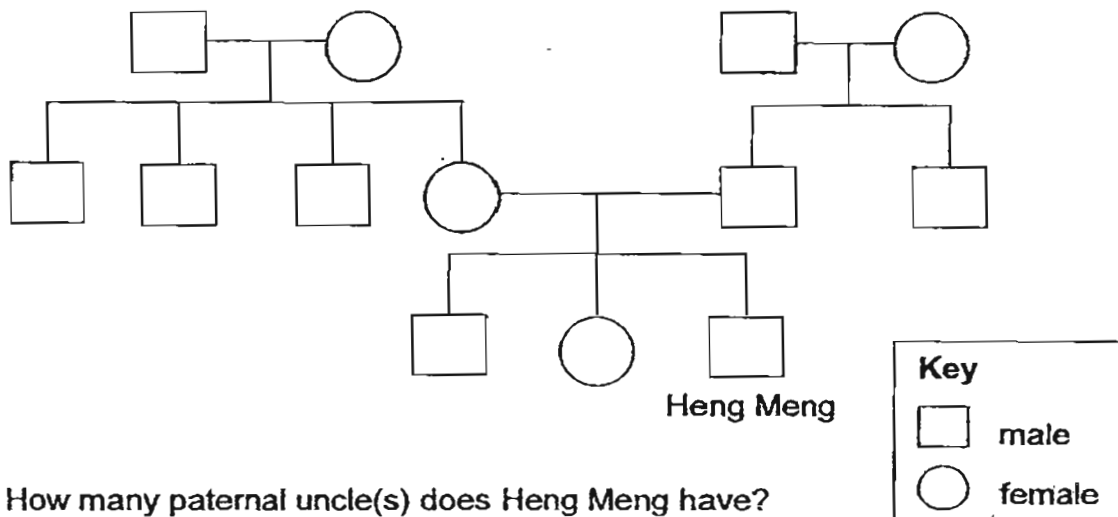

How many paternal uncle(s) does Heng Meng have?

- | | | | |
|-----|---|-----|---|
| (1) | 1 | (2) | 2 |
| (3) | 3 | (4) | 4 |

2. Which of the following statements about reproduction in organisms is/are true?

- A Unicellular organism reproduces asexually only.
- B Reproduction in organisms ensures continuity of their own kinds.
- C In sexual reproduction, there must be exchange of genetic material between 2 parents.
- D Male organisms produce more reproductive cells than female animals to ensure that at least one offspring will inherit all their traits only.

- | | | | |
|-----|-----------------|-----|-----------------|
| (1) | A and C only | (2) | B and C only |
| (3) | A, B and C only | (4) | A, B and D only |

3. Study the flowchart below.

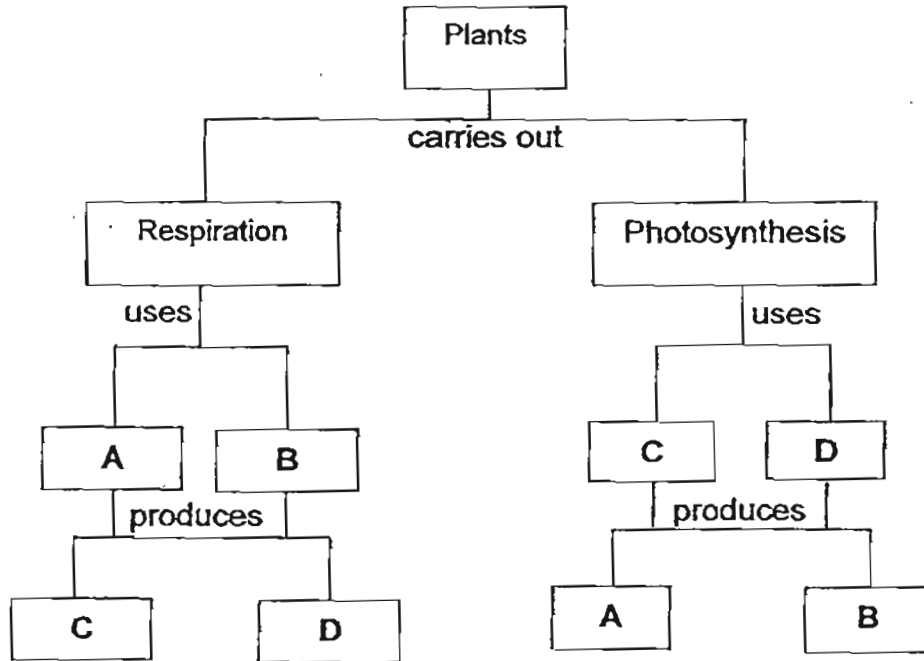

Which one of the following correctly represents A, B, C and D in the flowchart?

	A	B	C	D
(1)	oxygen	energy	carbon dioxide	food
(2)	food	oxygen	energy	carbon dioxide
(3)	water	oxygen	food	carbon dioxide
(4)	water	carbon dioxide	food	oxygen

4. The diagram below shows the flow of water through the gills of the fish.

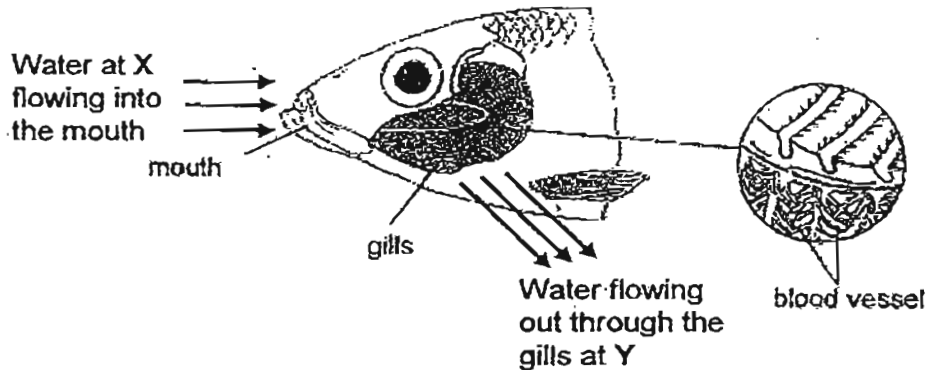

Which of the following statements best describe the water that flows through the gills?

- A There is more dissolved air in water at Y than X.
- B Oxygen content of water at X is higher than that of water at Y.
- C Carbon dioxide content of water at X is lower than that of water at Y.
- D Content of carbon dioxide is higher than content of oxygen of water at Y.

- | | |
|---------------------|---------------------|
| (1) A and D only | (2) B and C only |
| (3) A, B and C only | (4) A, B and D only |

5. A severely overweight patient had his small intestine shortened to help him to reduce weight.

Which of the following explain how the shortening of small intestine can help the patient in his attempt to lose weight?

- A. Less food is digested.
- B. Less water is absorbed.
- C. Less digested food is absorbed.

- | | |
|------------------|------------------|
| (1) A only | (2) B only |
| (3) A and B only | (4) A and C only |

6. The diagram below shows a single-celled organism k.

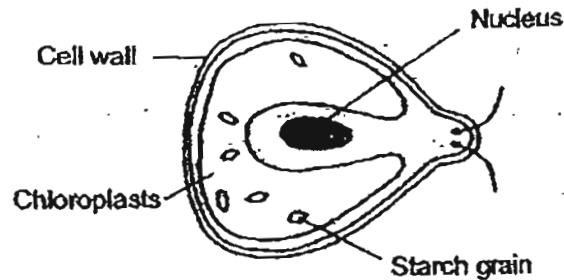

Which one of the following statements about the organism is **incorrect**?

- (1) This organism can reproduce.
 - (2) This organism has a regular shape.
 - (3) This organism can make its own food.
 - (4) This organism is animal-like since it has structures that look like feelers and eyes.
7. The graph shows the changes in the height of Mr Ahmad from birth to the age of 70.

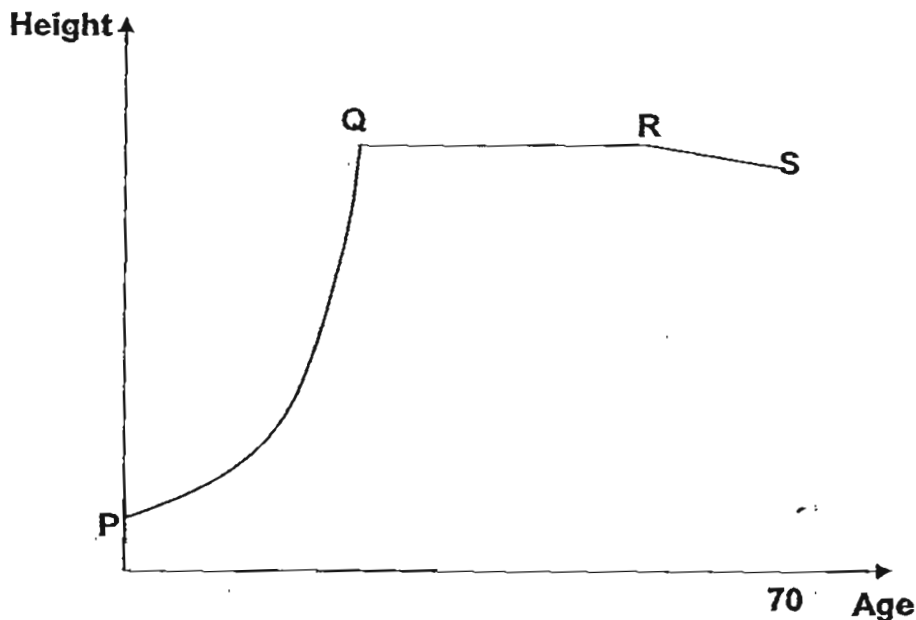

Which one of the following statements about the graph is **correct**?

- (1) Cell division had stopped in Mr Ahmad's body from Q to R.
- (2) Mr Ahmad grew taller from P to Q because the number of cells in his body increased.
- (3) As Mr Ahmad grew older, his cells shrank resulting in him becoming shorter from R to S.
- (4) Cells in Mr Ahmad's body changed in shape that resulted in his height increasing from P to Q.

8. Raja collected some Specimen H in the school eco-garden to conduct a few investigations on it.
Which of the following investigations correctly matches the aims of his finding involving Specimen H?

	Aim	Investigation
A	To find out if Specimen H is edible	Cut Specimen H into half.
B	To find out if Specimen H is dispersed by water	Place Specimen H in water.
C	To find out if Specimen H is wind-pollinated	Examine if H has a wing-like structure.
D	To find out if Specimen H is dispersed by wind	Release Specimen H in front of a working fan and see if it can travel a long distance.
E	To find out if Specimen H contains a seed that will germinate	Place Specimen H in a pot of soil and water it every day.

- (1) A and C only
(2) B, C and D only
(3) B, D and E only
(4) A, B, D and E only

9. Ms Tan carried out an experiment to find out the conditions essential for the germination of seeds. She set up the experiment below using green beans.

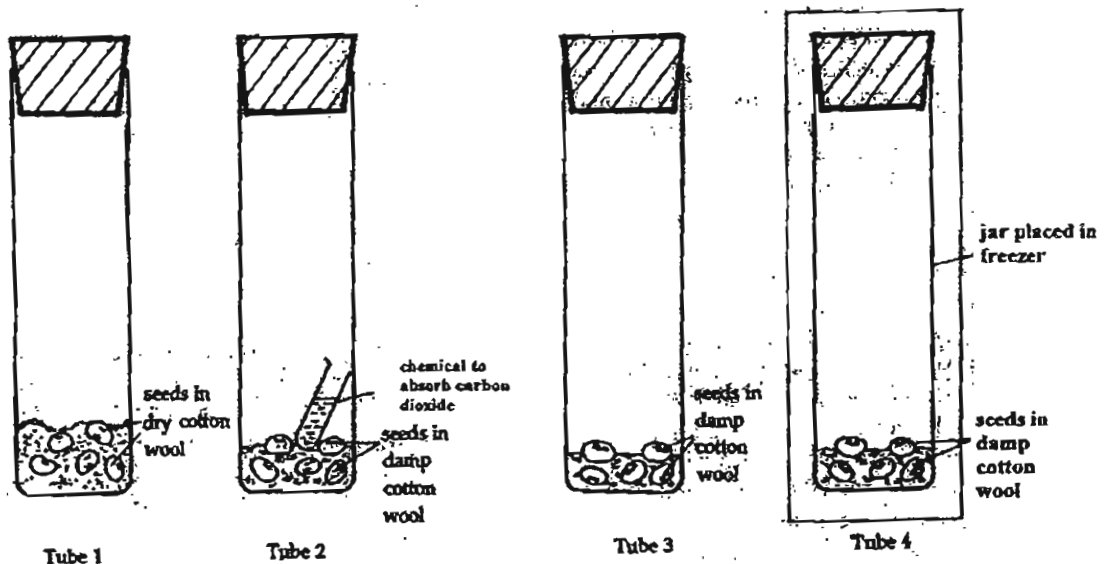

In which of the following tubes will the seeds germinate?

- (1) Tube 3 only
(2) Tube 1 and 3 only
(3) Tube 2 and 3 only
(4) Tube 2 and 4 only

10. The table shows properties of four powdered-substances J, K, L and M.

Substances	Colour	Water Soluble	Magnetic Material
J	White	Yes	No
K	White	No	No
L	Blue	Yes	No
M	Black	No	Yes

The four substances are mixed together.

Which one of the following pairs of substances would be most easy to separate?

- (1) J and K
- (2) K and M
- (3) J and L
- (4) L and M

11. Which one of the following actions demonstrates the disadvantage of frictional force?

- (1) Xavier striking a match.
- (2) Lin Qi holding a glass of water.
- (3) Siti pushing a box across the room.
- (4) Muthu sharpening his pencil using a pencil sharpener.

12. Study the diagram below.

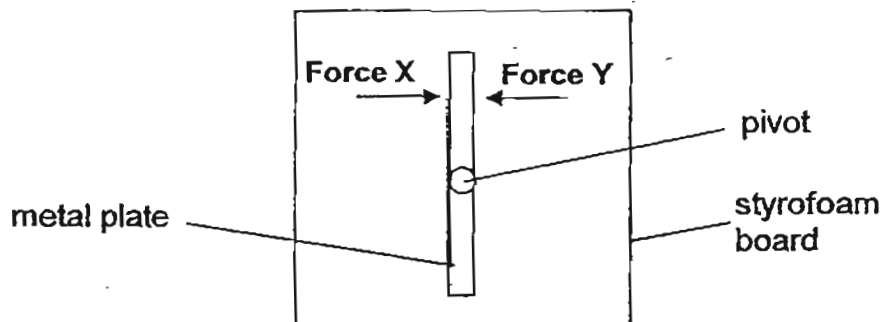

A piece of thin metal plate was attached loosely to a styrofoam board such that it was free to spin about the pivot. Force X is applied to the metal plate. Force Y is applied in the opposite direction.

Which one of the following observations and conclusions is incorrect?

Observations	Conclusions
(1) Metal plate did not spin.	Force X is equal to Force Y
(2) Metal plate spin in clockwise direction.	Force X is greater than Force Y
(3) Metal plate spin in anti-clockwise direction.	Force X is smaller than Force Y
(4) Metal plate spin in clockwise direction.	Force X is smaller than Force Y

13. The diagram below shows a paper clip "floating" in the air. The paper clip is attached to a 10cm-string.

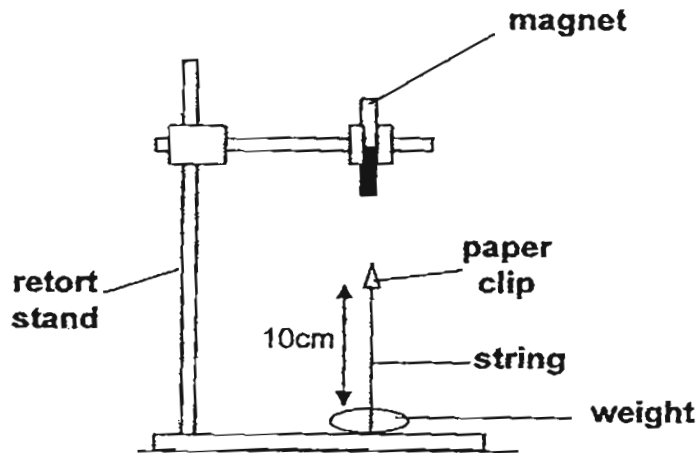

The magnet was then heated over a flame for a few seconds. If the above experiment was repeated after the magnet cooled down. Which one of the following would be the correct observation and explanation?

	Observation	Explanation
(1)	The paper clip attached to the 10cm-string will not "float".	The magnet had lost some of its magnetism during heating.
(2)	The paper clip attached to the 10cm-string will not "float".	The magnet had lost all its magnetism and become a non magnetic material.
(3)	The paper clip attached to the 10cm-string will still "float" in the air.	Heating had increased the strength of the magnet.
(4)	The paper clip attached to the 10cm-string will still "float" in the air.	Heating had changed the poles of the magnet.

Based on the experiment below, answer Question 14 and Question 15.

Eng Fong carried out an experiment by pulling a box across material A using a spring balance. He recorded the amount of force he needed to pull the box across Material A. He also measured the temperature of the contact surface of the box immediately after it was pulled across Material A. He repeated the experiment using another 2 boxes over 2 other Material B and C.

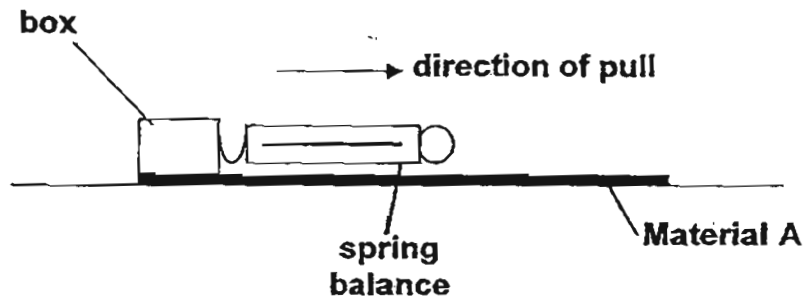

The table below shows his experimental results.

Material	Force needed to pull box across material	Temperature of contact surface of box
A	30 N	32°C
B	40 N	35°C
C	20 N	31°C

14. Which of the following variables should he keep the same in order for his experiment to be fair?

- A The box has the same mass.
- B Mass of the material must be the same.
- C The force to pull the box must be the same.
- D He should carry out the experiment in the same place.

- (1) A only
- (2) B and D only
- (3) A, B and C only
- (4) A, B, C and D

15. Which one of the following cannot be concluded from the experiment above?

- (1) The rougher the surface, the more heat will be produced.
- (2) Material B is the roughest as the temperature of surface contact of the box is the highest.
- (3) Material B has the greatest mass as the temperature of surface contact of the box is the highest.
- (4) Material A is rougher than Material C as the force needed to move box over material A was greater than that for C.

16. Aisha had 2 beakers, S and T, each containing 250ml of pure water. In Beaker S, Aisha added 20g of Substance X, which dissolved in the water. She put the 2 beakers in the freezer for 20 minutes. Then, she removed the beakers from the freezer and heat them over a bunsen burner for 15 minutes.

Aisha recorded her results in the table below.

	Beaker S (water + Substance X)	Beaker T (water)
20 min in freezer	remained as water	frozen into ice
15 min of heating	temperature of water increased	water was boiling

Based on the experiment above, what could Aisha conclude about how Substance X had affected the freezing point and boiling point of pure water?

- (1) Substance X increased the freezing point and boiling point of water.
 - (2) Substance X decreased the freezing point and boiling point of water.
 - (3) Substance X increased the freezing point and decreased the boiling point of water.
 - (4) Substance X decreased the freezing point and increased the boiling point of water.
17. Paul placed a metal cup with a plastic cover in the air-conditioned room for 5 hours. After 5 hours, he observed that the metal cup was colder to touch than the plastic cover.

Which one of the following statements best explain his observation ?

- (1) The metal cup lost heat to the hand faster than the plastic cover.
- (2) The plastic cover conducted heat from his hand slower than the metal cup.
- (3) The plastic cover was warmer than the metal cup and it transferred heat to the hand.
- (4) His hand gained more heat from the surrounding air when touching plastic cover than when touching the metal cup.

19. Michael placed a glass ball, a book and an opaque plastic sheet in a straight line between a torch and a white screen as shown below.

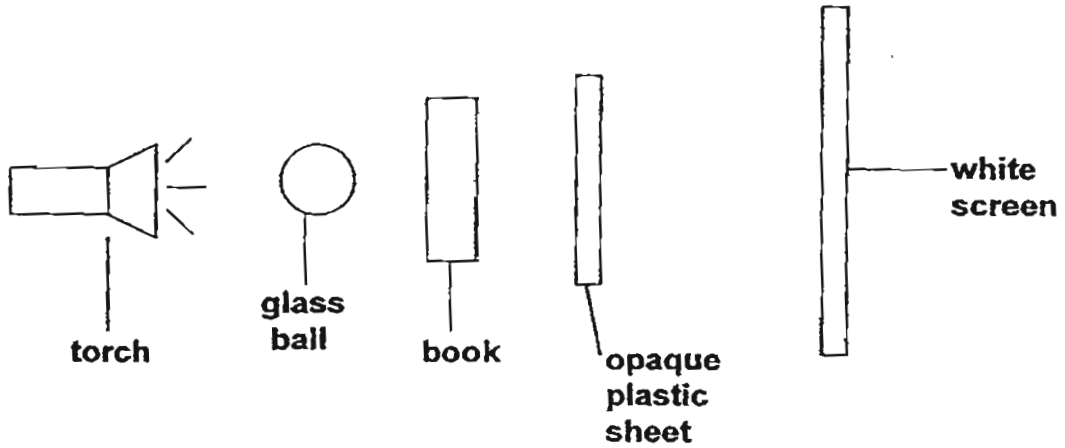

How many different shadow(s) would Michael see on the white screen?

- (1) 1
 (2) 2
 (3) 3
 (4) 4
20. A room with 2 mirrors fixed at different spots is as shown below.

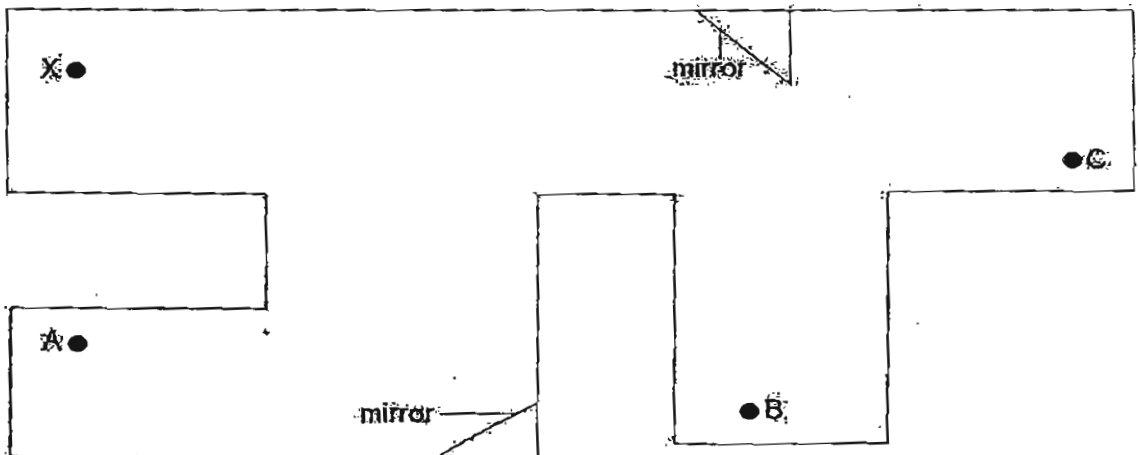

An object was placed at point X. At which position(s) A, B, or C would a person be able to see the reflection of the object?

- (1) A only
 (2) B only
 (3) B and C only
 (4) A, B and C

21. Mr Lim tested the properties of several types of metals and found that these metals were able to conduct electricity and could be made into temporary magnets as well.

Which of the following metal is/are examples of such metals?

- A Iron
- B Steel
- C Copper
- D Aluminium

- (1) A and B only
- (3) A, B and C only

- (2) C and D only
- (4) A, B, C and D

22. Study the circuit diagram as show below. All the bulbs and batteries are similar and new.

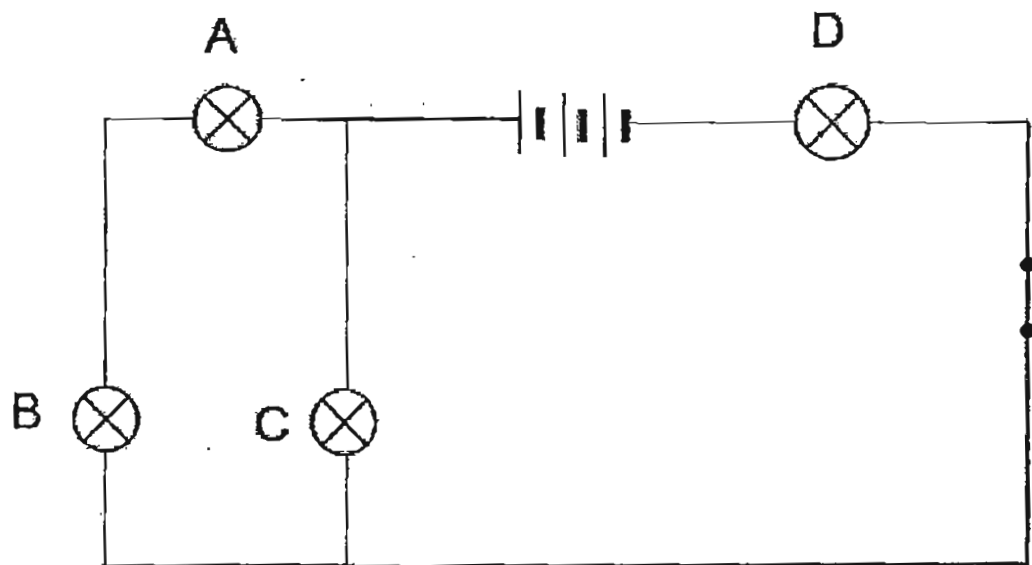

Which bulb, when blown, will result in all the rest of the bulbs not lighting up?

- (1) A
- (3) C

- (2) B
- (4) D

23. The diagram below shows an incomplete diagram of a bulb.

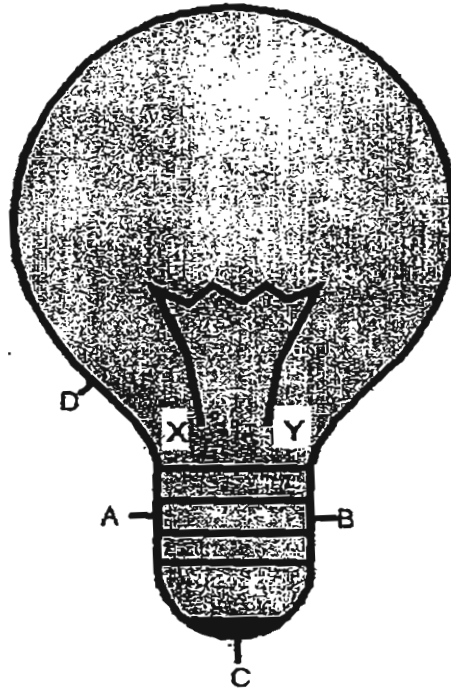

Which points should X and Y be connected to in order for the light bulb to light up when electric current is flowing through?

	X to be connected to	Y to be connected to
(1)	A	B
(2)	A	C
(3)	A	D
(4)	C	D

24. A group of students studied the circuit card with connecting points W, X, Y and Z. The circuit card is shown below.

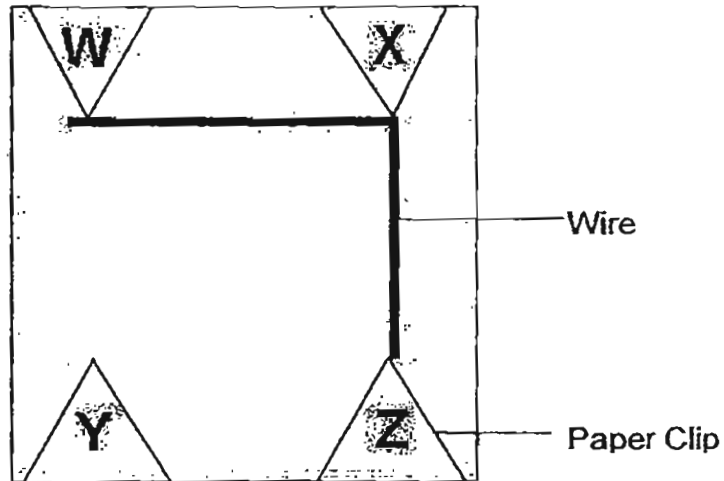

The following comments were made by the pupils..

- A A bulb will light up if it is connected to X and Y.
- B A bulb will not light up if it is connected to W and Z.
- C A bulb will not light up as long as one point is connected ~~Wire~~ ^{to point Y}
- D A bulb will light up if it is connected to any of the 2 connecting points.

Which of the following comment(s) made is/are true?

- (1) B only
- (2) C only
- (3) A and D only
- (4) C and D only

25. Rachel set up the circuit as show below.

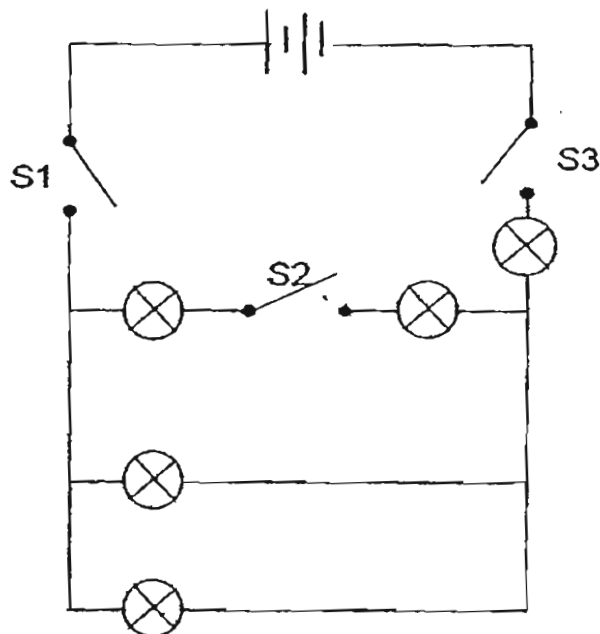

Which of the following switches should she close in order for 3 bulbs to light up only?

- A S1 and S2
- B S1 and S3
- C S2 and S3
- D S1, S2 and S3

- (1) B only
- (2) D only
- (3) B and D only
- (4) A, C and D only

26. Tommy and his friends were discussing some of the possible methods of saving electricity at home. Some of the following methods that were discussed are stated below.

- A Using the air-conditioner instead of the fan.
- B Take a shower using cold water during a hot day.
- C Open the doors of the fridge to help us cool down.
- D Leaving the switch on when an electrical device is not in use.

Which of the following are effective methods to conserve electricity in a household?

- (1) B only
- (2) C and D only
- (3) A, B and C only
- (4) A, B and D only

27. Karen set up the circuit as shown below.

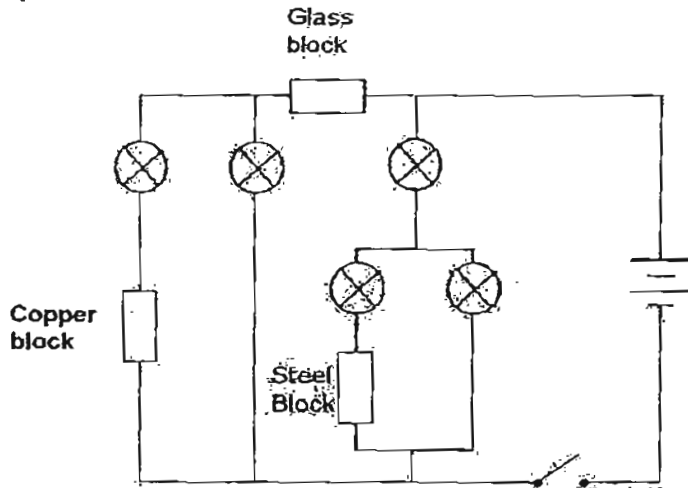

How many bulbs would light up when he closed the switch?

- (1) 2
- (2) 3
- (3) 4
- (4) 5

28. Tommy set up the circuits as shown below.

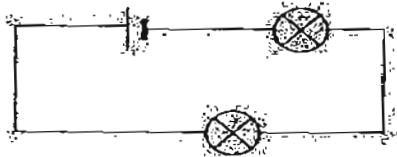

(A)

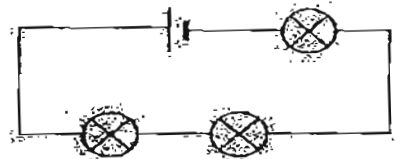

(B)

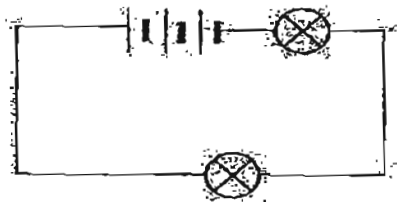

(C)



(D)

Arrange the circuits with the bulbs in order from the brightest to the dimmest.

	Brightest	→		Dimmest
(1)	C	D	A	B
(2)	B	A	C	D
(3)	A	C	D	B
(4)	D	C	A	B

29 Mrs Lee gave her 4 of her students the following details of a circuit card that she was holding.

Circuit tester connected to points	Does the bulb light up?
V and X	Yes
W and Y	Yes
X and Y	Yes
Y and Z	No
Z and W	No

The 4 students went on to construct their own circuit cards.

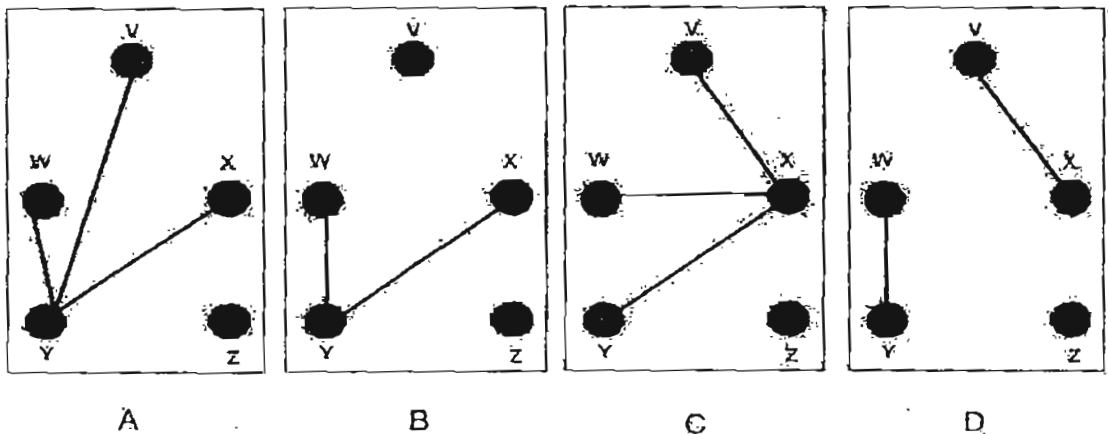

Which of the following circuit cards would work in the same manner as Mrs Lee's circuit card?

- (1) A and C only
- (2) B and D only
- (3) A, B and C only
- (4) B, C and D only

30 The diagram below shows a typical electrical plug.

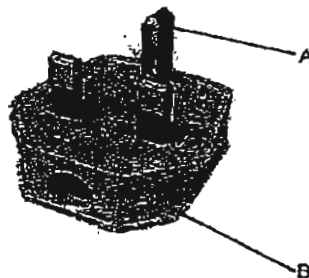

Which of the following are possible materials used for making A and B?

	A	B
(1)	Plastic	Plastic
(2)	Rubber	Steel
(3)	Iron	Plastic
(4)	Steel	Iron

NANYANG PRIMARY SCHOOL
PRIMARY 5 SCIENCE
SECOND SEMESTRAL ASSESSMENT
2011

BOOKLET B

Date : 2 NOVEMBER 2011

Duration : 1 h 45 min

Name : _____ ()

Class: Primary 5 ()

Marks Scored:

Booklet A:		60
Booklet B :		40
Total :		100

Parent's signature: _____

**DO NOT OPEN THIS BOOKLET UNTIL YOU ARE TOLD TO DO SO.
FOLLOW ALL INSTRUCTIONS CAREFULLY.**

Booklet B consists of 15 printed pages including this cover page.

Section B (40 marks)

Write your answers to questions 31 to 46 in the spaces provided.
Marks will be deducted for misspelt key words.

31. Mice of equal size and age were each placed in enclosed containers of various capacities. After 15 minutes, the breathing rate of each mouse was measured and recorded in a table below.

Container	Breathing rate per minute of the mouse after 15 minutes
A	75
B	90
C	115

Breathing rate per minute of the mouse after 15 minutes

- (a) Using the data recorded in the table above, explain why the capacity of Container C was the smallest. (2 marks)

- (b) When the mice exercised, their breathing rate increased. Give 2 reasons for the increase in breathing rate of the mice. (2 marks)

(i) _____

(ii) _____

32. In an experiment, a complete ring of bark including the food-carrying tubes was cut off each stem of 2 plants, X and Y. The water-carrying tubes were exposed at a different part of the stem of each plant depending on where the ring was cut. A third plant, Z, was left untouched. These 3 plants were then placed in beakers containing the same amount of water as shown in the diagram below.

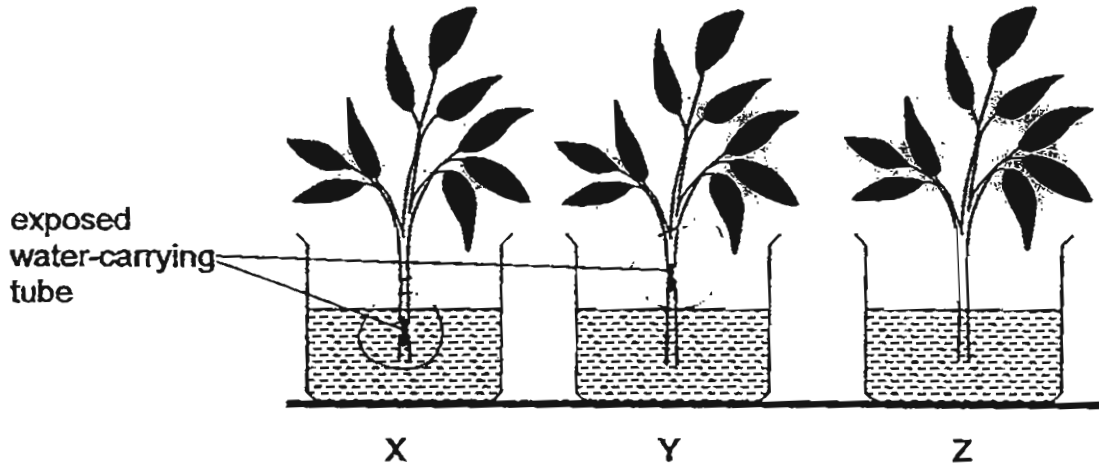

The observations of Plant X and Z were recorded in the table below.

Plant	Observations after 1 week
X	<ul style="list-style-type: none"> ● the stem above the cut ring swells a little ● plant is still growing well and healthy
Z	<ul style="list-style-type: none"> ● there was no swelling on the stem ● plant is still growing well and healthy

- (a) Write down 2 observations of plant Y. (2 marks)

(i) _____

(ii) _____

- (b) Explain the swelling observed at the stem above the cut ring in Plant X. (1 mark)

- (c) What is the purpose of Plant Z in the experiment? (1 mark)

33. The diagrams below show longitudinal sections of 2 flowers, F and G.

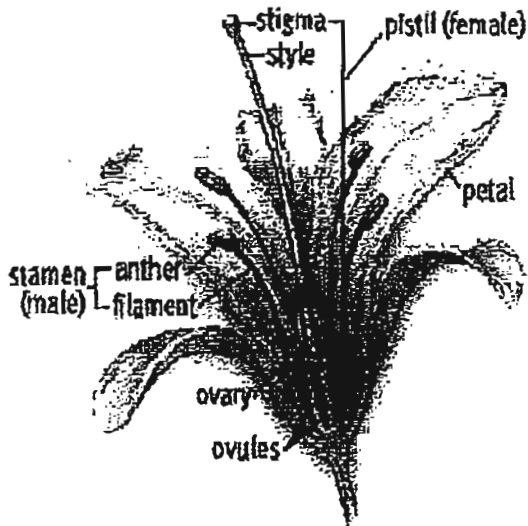

Flower F

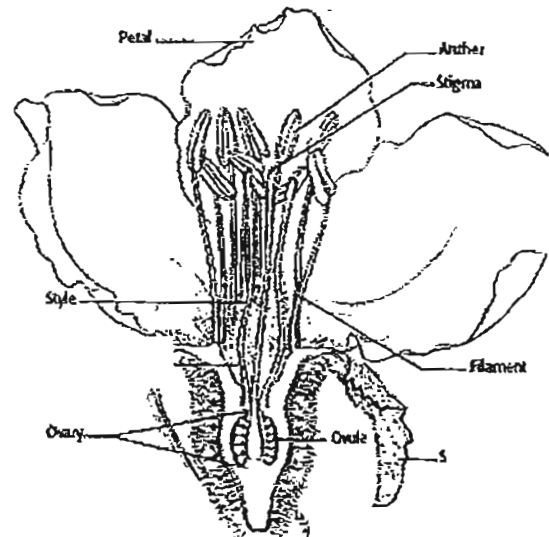

Flower G

Which flower is more likely to be pollinated by wind? Give 2 reasons to support your choice. (2 marks)

- (i) _____
- _____
- (ii) _____
- _____

34. When Farina opened the doors of a 2 compartment refrigerator one at a time, she noticed that more "white clouds" escaped from left compartment than the right compartment. Explain Farina's observation. (2 marks)

- _____
- _____
- _____
- _____

35. Mr Rahim carried out an experiment to show his pupils the importance of a cell part to a plant cell.

He placed a balloon, which was filled with 400ml of water, in a wooden box of capacity of 500ml. Mr Rahim covered the lid of the box and told the class that the balloon together with the box represented the model of a plant cell.

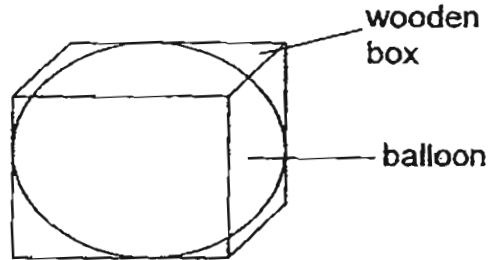

Through a hole in the box, Mr Rahim could only pump in another 55ml of water into the balloon in the box with the lid closed. Then Mr Rahim removed the balloon from the box. He could pump another 150ml of water into the balloon before it burst.

- (a) Which cell part do you think the box represents? (1 mark)

- (b) From Mr Rahim's experiment, what is the importance of the cell part in (a) to plant cell? (1 mark)

36. The diagram below shows an experiment that was carried out with a container of water with a temperature of 80°C . A metal spoon, at room temperature, was put into the water and the temperature of the water was recorded after 3 minutes. 9 more spoons, with the same temperature, were added one at a time and the temperature of water was taken each time.

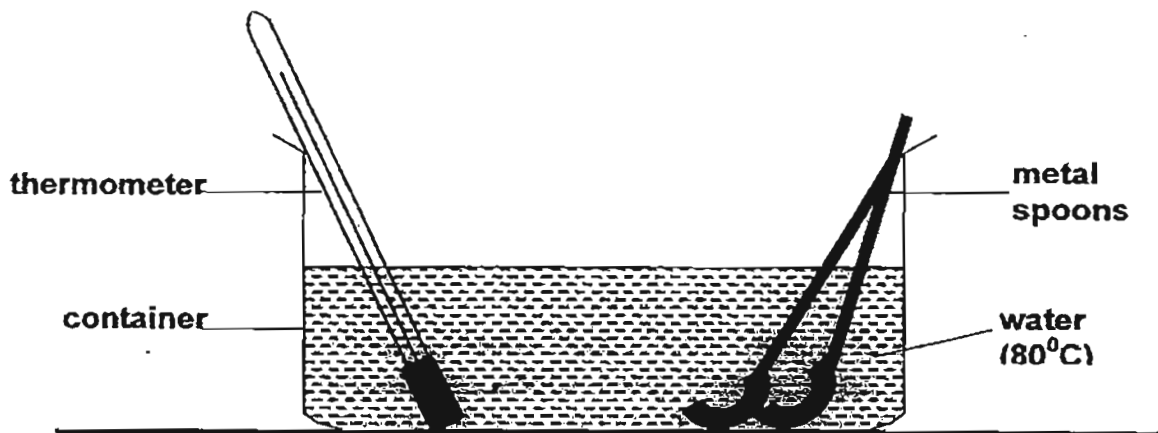

A graph was plotted based on the results collected.

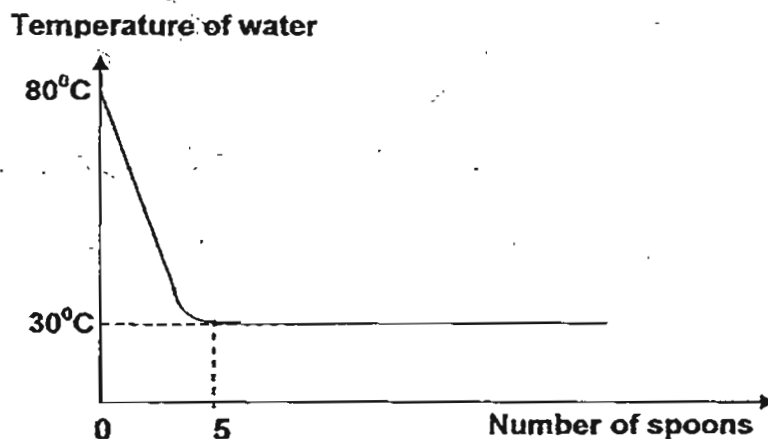

- (a) What is the relationship between the temperature of the water and the number of spoons added? (2 marks)

(b) Explain the relationship in (a)..

(2 marks)

37. The diagram below shows the Maglev train.



The magnetic levitation (Maglev) train

The Maglev train uses repelling magnetic force of the electromagnets between the train and the track to float the train slightly above the track.

Compared to a train with wheels running on its track, explain how the Maglev train can travel at a much higher speed? (2 marks)

38. The original length of a spring is 10 cm. Ravi put different weights on the spring and recorded the length of the spring compressed by the weight. The spring remained at 4 cm after weights of 150g or more were placed on the spring.

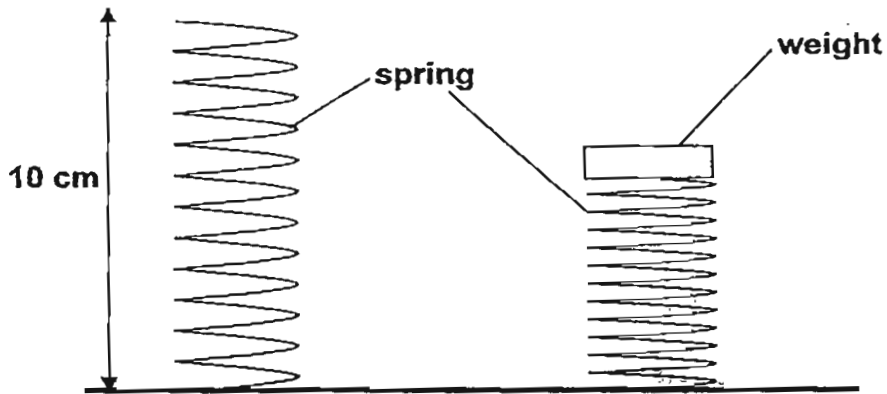

- (a) Based on the above information, draw in the graph below, to show how the length of the spring will be affected by the mass of weights put on the spring increases. (2 marks)

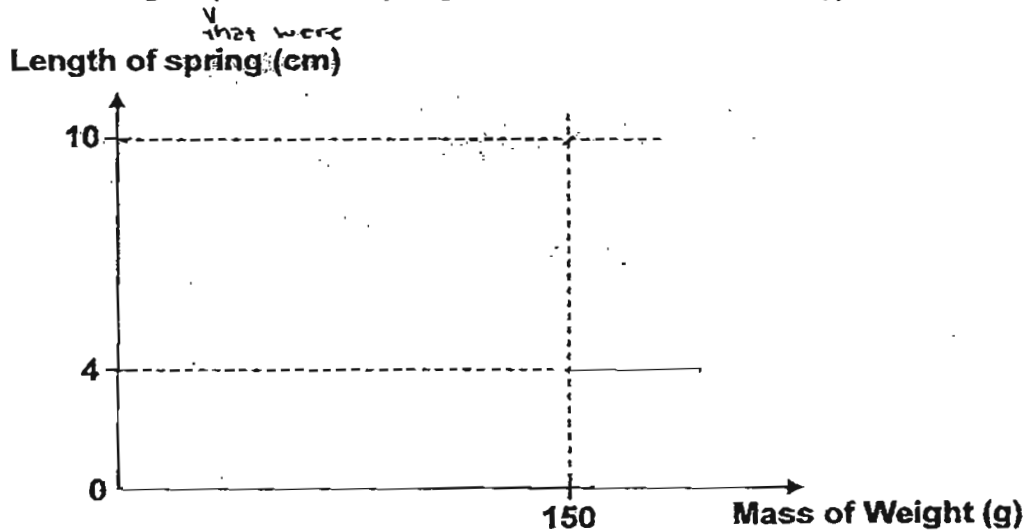

- (b) State and explain the observation when a weight of 150g or more was placed on the spring. (1 mark)

39. The diagram below shows a bend along a 2 way road.

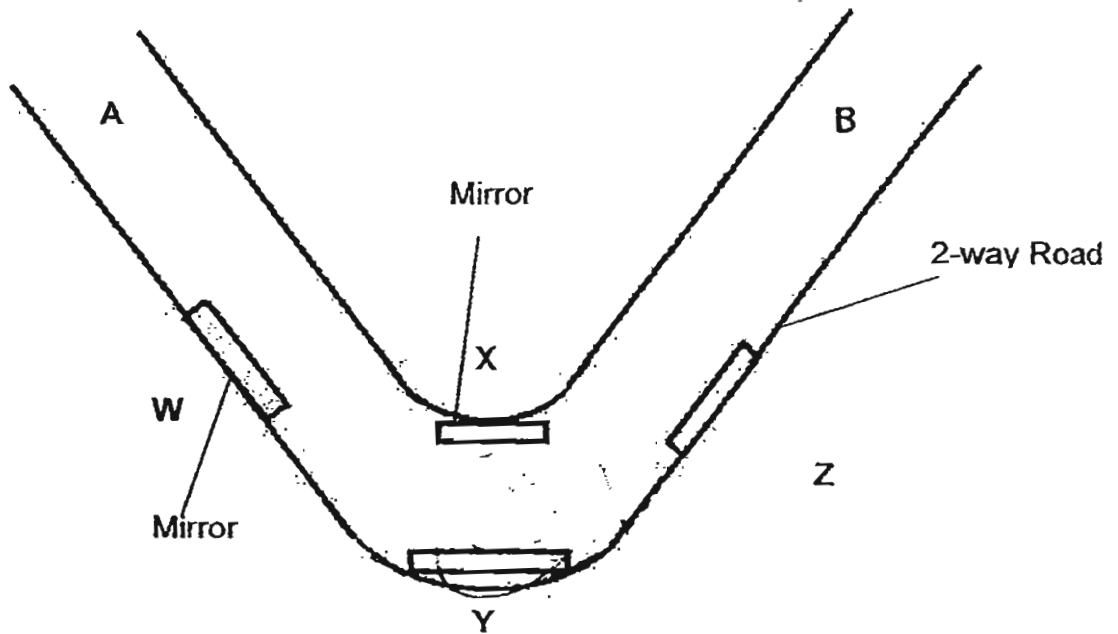

Two cyclists A and B were travelling towards each other.

- (a) In the diagram above choose a mirror and draw the light ray diagram reflection which enables cyclist B to see cyclist A at their current position. (2 marks)
- (b) Name the property of light which enables the cyclist to see one another. (1 mark)

40. Tommy set up the experiment as shown below. He filled a bottle with some water and measured the mass using a beam balance. A beam balance is a tool use for measuring mass.

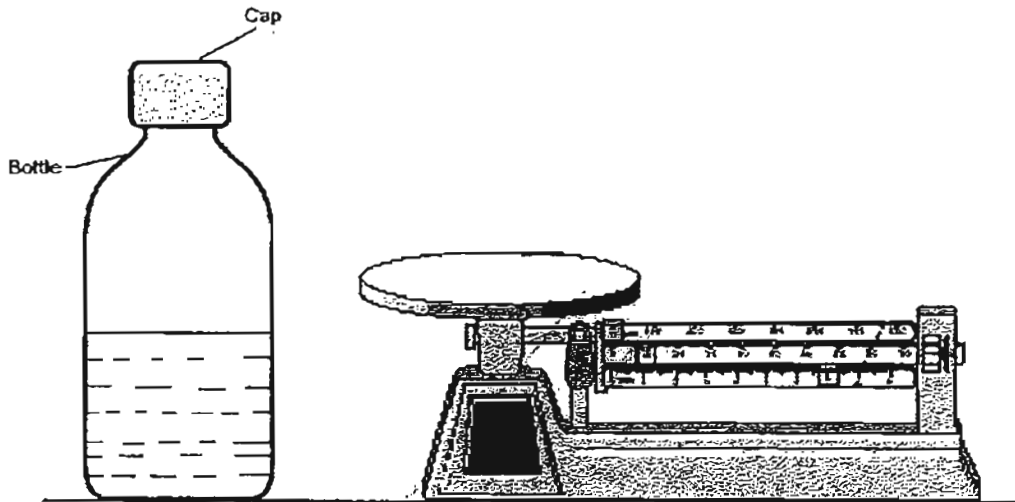

Beam Balance

Tommy heated the bottle over a stove for 2 minutes and measured the mass of the bottle and its contents again.

Suggest whether the mass of the bottle with water increase, decrease or remains the same after heating and explain your answer. (2 marks)

41. Dexter was given a beaker containing a mixture of iron filings, sugar and small tiny plastic ball-bearings. They were all of similar size.

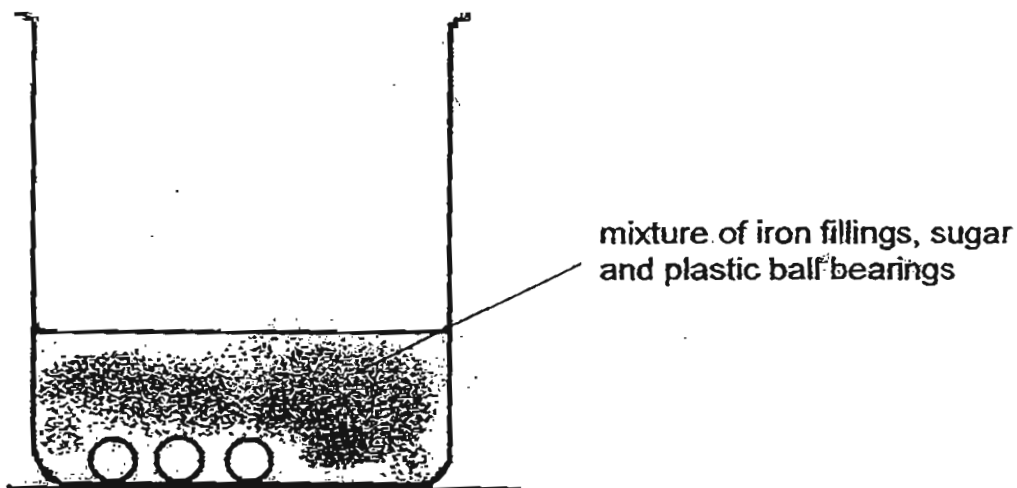

Dexter was also given the following items:

- 1) a beaker of water
- 2) a table spoon
- 3) a strong U-shaped magnet

Using all the items given above, describe how Dexter could separate the iron filings, sugar and the plastic tiny ball-bearing in the mixture without using his fingers. (3 marks)

Step	Procedure	Item Separated
1		
2		
3		
4		
5		
6		

42. The diagrams below show the interior of a public bus.



Bus Stopping Sign

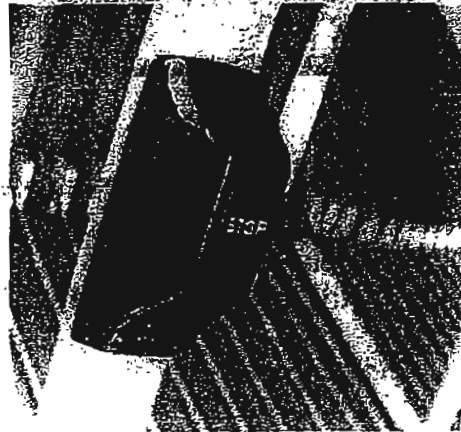

'Stop' button

A passenger who wishes to alight presses the "Stop" button then the bell will ring and at the same time, the "Bus Stopping" sign will flash to notify the bus driver and the rest of the passengers that someone wants to alight. The "bus stopping" sign, the "stop" buttons and the bell are connected by wires.

- (a) Using all the simplified representations provided below, draw the circuit diagram to show how the "Stop" buttons, "Bus Stopping" sign, "Power Source" and the "Bell" are connected so that it worked as described. (2 marks)

Representations			
Power Source	Bell	Stop Button	Stop Button
Bus stopping sign	Stop Button		

Draw in this box

Circuit Diagram

- (b) List one advantage of the type of circuit you have drawn above. (1 mark)

43. Study the experiment setup as show below. The circuit diagram shows 3 gaps, A, B and C respectively.

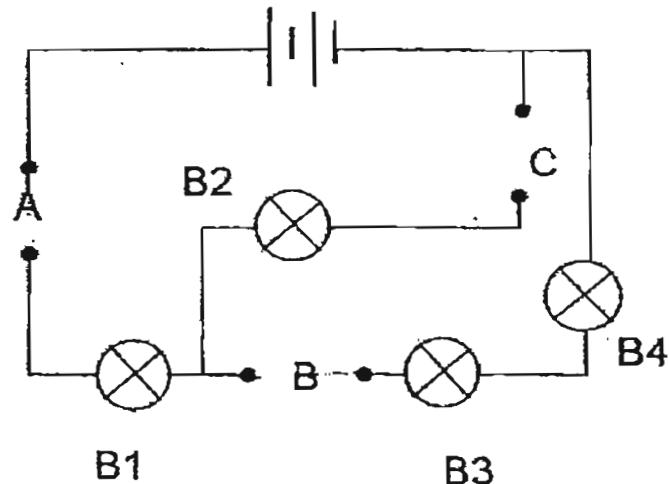

Michael has 3 rods, X, Y and Z. The rods were placed to close the respective gaps, A, B and C and the results were as shown below.

Rod	Position of rod			Bulb(s) that will light up			
	X	Y	Z	B1	B2	B3	B4
Gap	A	B	C	✓	✓		

- (a) Based on the results above state whether rods, X, Y and Z are conductors or insulators of electricity. (1.5 marks)

Rod X: _____

Rod Y: _____

Rod Z: _____

- (b) Michael rearranges the position of the rods as shown in the table below. Place a tick (✓) against the bulb(s) that will light up. (1.5 marks)

Rod	Position of rod			Bulb(s) that will light up			
	X	Y	Z	B1	B2	B3	B4
B	C	A		✓		✓	✓

44. Tom setup the following experiments as shown below. All the batteries and bulbs are new and similar.

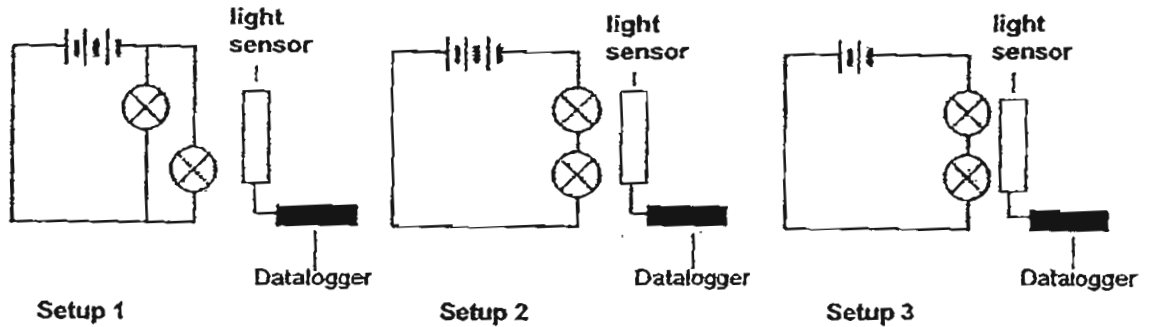

- (a) What was the aim of Tom's experiment if he used Setup 1 and Setup 2 only? (1 mark)

- (b) What was the aim of Tom's experiment if he used Setup 2 and Setup 3 only? (1 mark)

- (c) Why is it necessary for Tom to take several readings from the datalogger for each set up? (1 mark)

—————END OF PAPER—————

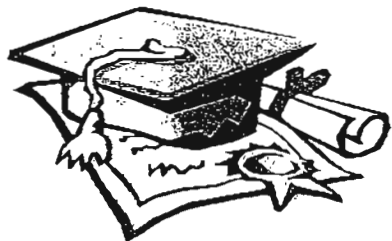

ANSWER SHEET

EXAM PAPER 2011

**SCHOOL : NANYANG
SUBJECT : PRIMARY 5 SCIENCE**

TERM : SA2

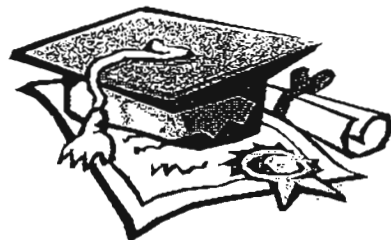

Q1	Q2	Q3	Q4	Q5	Q6	Q7	Q8	Q9	Q10	Q11	Q12	Q13	Q14	Q15	Q16	Q17
1	3	2	2	4	4	2	3	3	2	3	4	1	1	3	4	2

Q18	Q19	Q20	Q21	Q22	Q23	Q24	Q25	Q26	Q27	Q28	Q29	Q30
3	1	2	1	4	2	4	1	1	2	1	1	3

31)a) Container C had the smallest capacity as the mice breathing rate was the fastest. When container C had a small capacity, the mice did not have enough oxygen. Thus, it breathe faster to inhale more oxygen which was needed.

b)i) The mice needed more energy and had to breathe faster to inhale more oxygen to be converted to more energy with digested food.

ii) To get rid of excess carbon dioxide.

32)a)i) The stem above the cut ring swells a little.

ii) The plant is dying.

b) Food that was made in the leaves of plant X were supposed to be transported to the others parts of the plant (roots). When the food-carrying tube was cut, the food could not be transported to the roots of the plant and thus, swelled up.

c) It was to act as a control set-up to show the changes caused were caused by the cut phloem tube.

33)i) Flower F. The stigma is sticking out above the petals in Flowers F so it can receive the pollen grains blown by the wind but the stigma in Flower G.

ii) The petals of Flower G are big and block the wind from blowing the pollen grains away but the petals of Flower G are smaller and bend out so the wind can blow the pollen grains away easily.

34) The left compartment is colder than the right. The water vapour in the surrounding air loses heat faster in the left compartment and condenses on the cold air forming "white clouds".

35)a) I think it represents the cell wall.

b) The cell wall limits the amount of water entering the cell. Thus, when excess water is present, it will not burst.

36)a)The more the number of metal spoon added, the lower the temperature of the water. But when 5 spoons or more are added, the temperature remains at 30°C

b)The spoons are made of metal and are a good conductor of heat. Thus, when in is put in the container, it conducts heat away until the temperature has reach room temperature.

37)The train that runs with wheels generates more friction than the Maglev train as it runs on a magnetic force. Friction slows down and stops an object. Thus, the rain that run on wheels will be slower as it generates friction between its' wheels, and the track. While the Maglev train is floating and does not create so much friction.

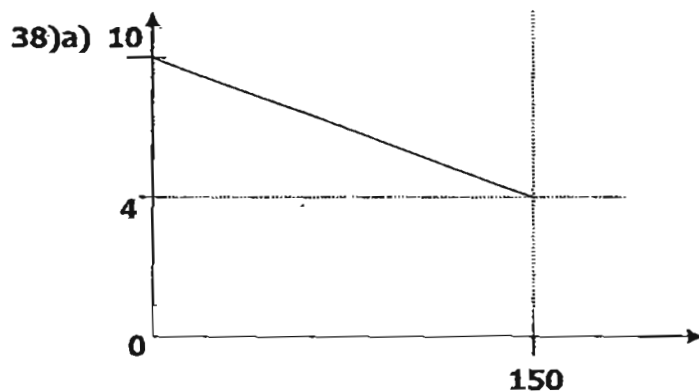

b)When a weight of 150g or more was put on the spring, the spring was compressed till it's maximum elasticity limit and could not be compressed anymore.

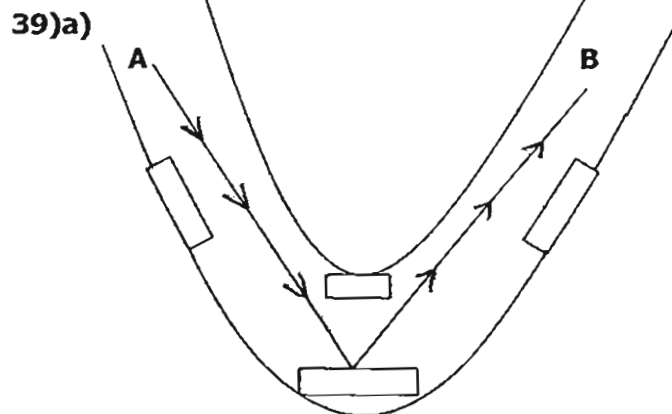

b)Light can be reflected.

40)I think the mass of the bottle will stay/remain the same as the matter only changed shape but did not change in mass.

41)

Step	Procedure	Item Separated
1	Put the strong U-shaped magnet near the beaker	Iron fillings
2	Put the rest of of mixture into the water.	
3	Use the table spoon to scoop up the plastic ball bearings	Plastic ball bearings
4	Heat/leave the items there till only sugar crystals remains to let the water evaporate.	sugar/ water

42)a)

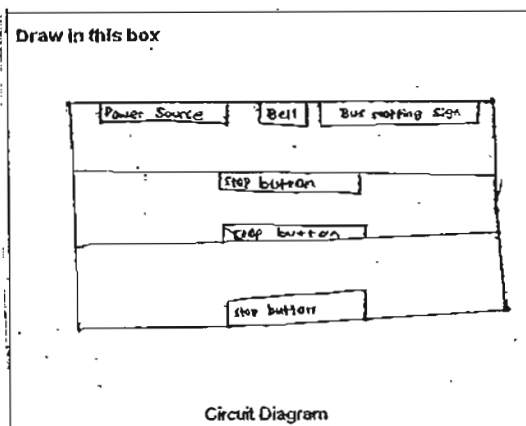

b)When one of the stop buttons stop working,(fuses)the other will continue to work.

43)a)X: conductor Y: insulator Z: conductor
 b)B1, B3, B4

44)a)It was to find out if Set-up 1, bulbs in parallel or Set-up 2 bulbs in series could produce a brighter light.

b)It was to find out whether the bulbs will be brighter with more batteries, when in series.

c)It it to ensure that the result of his experiment was reliable.