



**CATHOLIC HIGH SCHOOL  
CONTINUAL ASSESSMENT 1  
2017  
PRIMARY FIVE  
SCIENCE  
Booklet A**

Name: \_\_\_\_\_ ( )

Class: Primary 5 - \_\_\_\_\_

Date: 2 March 2017

Parent's Signature: \_\_\_\_\_

11 questions

22 marks

Total Time for Booklets A and B: 45 minutes

**INSTRUCTIONS TO CANDIDATES**

Do not turn over this page until you are told to do so.

Follow all instructions carefully.

Answer all questions.

Shade your answers in the Optical Answer Sheet (OAS) provided.

This booklet consists of 6 printed pages, excluding cover page.

**Booklet A (11 × 2 marks)**

For each question from 1 to 11, four options are given. One of them is the correct answer. Make your choice (1, 2, 3 or 4). Shade your answer on the Optical Answer Sheet.

(22 marks)

1 The diagram below shows two flowers from the same plant.

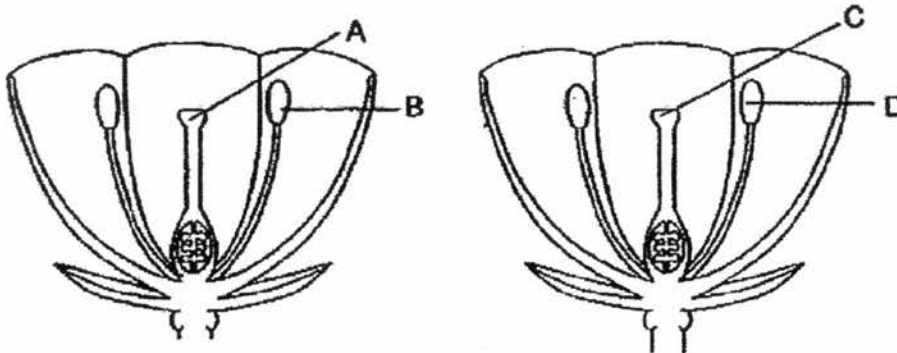

Pollination between these two flowers occurs when pollen grains are transferred from \_\_\_\_\_.

- (1) A to C
- (2) A to D
- (3) B to C
- (4) B to D

2 Arrange the following processes in the correct sequence.

- A pollination
- B fertilisation
- C germination
- D seed dispersal

- (1) A → B → C → D
- (2) A → B → D → C
- (3) B → C → A → D
- (4) B → D → C → A

- 3 Which part of the flower, if removed, would prevent the flower from forming a fruit?

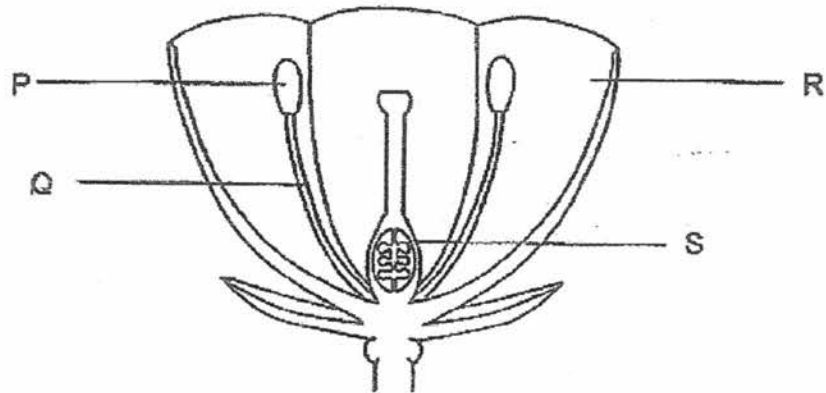

- (1) P  
 (2) Q  
 (3) R  
 (4) S
- 4 Fanny dropped two fruit, X and Y, from the same height and measured the time taken for each fruit to reach the ground.



fruit X



fruit Y

Which of the following set of readings is most likely correct?

	Time taken for fruit X to reach the ground (s)	Time taken for fruit Y to reach the ground (s)
(1)	3.3	5.3
(2)	4.5	5.5
(3)	5.3	3.3
(4)	4.5	4.5

- 5 Seeds W, X, Y and Z from a plant are placed under the conditions as shown in the table below. A tick (✓) in the box represents the presence of the condition for the seed.

seed	Conditions			
	air	water	light	temperature (°C)
W	✓	✓		35
X		✓	✓	35
Y	✓			35
Z	✓		✓	35

Which seed, W, X, Y or Z, would most likely germinate?

- (1) W  
 (2) X  
 (3) Y  
 (4) Z
- 6 The table below shows the different parts of the reproductive system of a plant and human.

Parts of the reproductive system	
Plant	Human
X	testis
male reproductive cell in the pollen grain	Y
ovary	ovary
female reproductive cell in the ovule	Z

Which of the following correctly represents X, Y and Z?

	X	Y	Z
(1)	anther	penis	ovule
(2)	filament	penis	egg
(3)	filament	sperm	ovule
(4)	anther	sperm	egg

7 Study the diagram below.

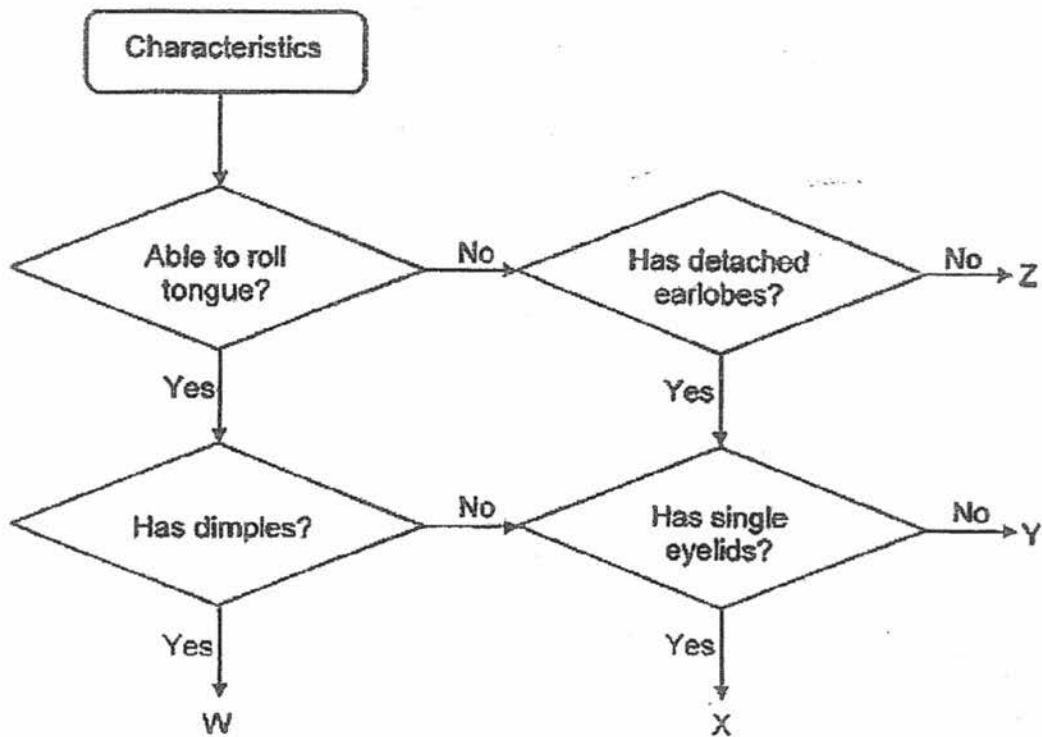

Cathy is unable to roll her tongue, has detached earlobes but does not have double eyelids. Which letter, W, X, Y or Z, best represents Cathy?

- (1) W
- (2) X
- (3) Y
- (4) Z

- 8 The diagram below shows the male and female reproductive systems.

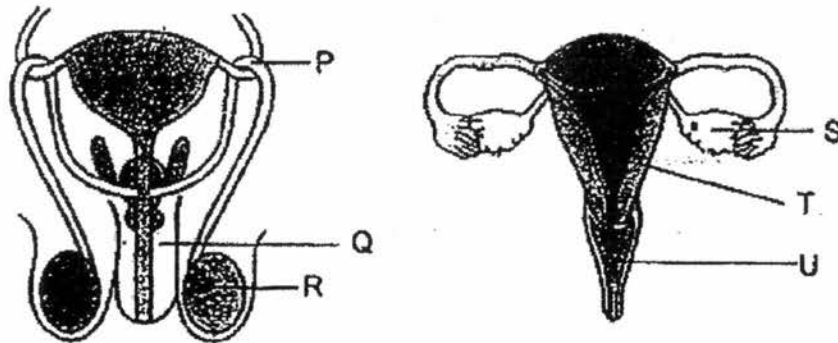

Which of the following is correct?

	Produces sperm cell	Produces egg cell	Place where the fertilised egg develops
(1)	P	T	U
(2)	R	S	T
(3)	S	R	U
(4)	Q	S	T

- 9 The diagram below shows the changes in the state of water.

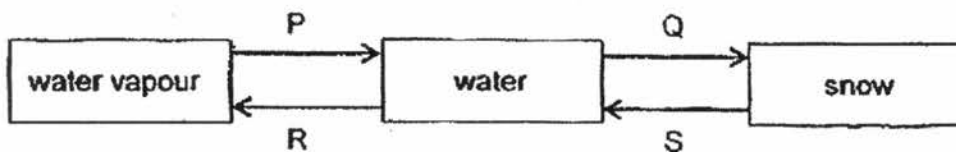

What do P, Q, R and S represent?

	P	Q	R	S
(1)	condensation	freezing	evaporation	melting
(2)	evaporation	melting	freezing	condensation
(3)	condensation	freezing	melting	evaporation
(4)	evaporation	melling	evaporation	freezing

- 10 Which one of the following correctly shows heat gain or loss for the processes?

	Process	Heat Involved
(1)	boiling	heat loss
(2)	melting	heat loss
(3)	condensation	heat gain
(4)	evaporation	heat gain

- 11 A beaker of ice was heated to 100°C before it was left to cool. The changes in temperature are shown in the graph below.

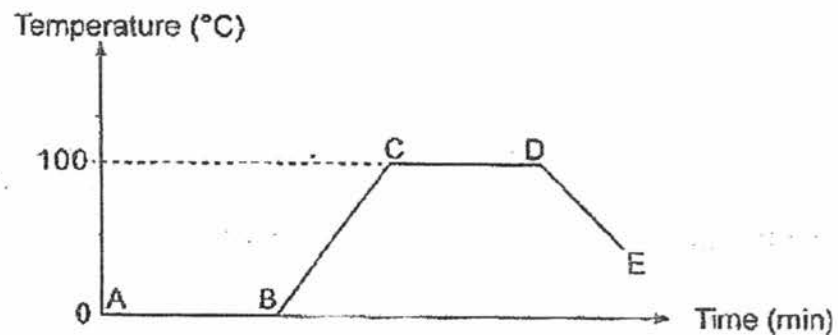

Based on the graph above, which one of the following is correct?

	Melting	Boiling
(1)	AB	CD
(2)	AB	BC
(3)	DE	CD
(4)	DE	BC

End of Booklet A



**CATHOLIC HIGH SCHOOL  
CONTINUAL ASSESSMENT 1  
2017  
PRIMARY FIVE**

**SCIENCE**

**Booklet B**

Name: \_\_\_\_\_ ( )

Class: Primary 5 - \_\_\_\_\_

Date: 2 March 2017

Parent's Signature: \_\_\_\_\_

6 questions

18 marks

Total Time for Booklets A and B: 45 minutes

Booklet A	22
Booklet B	18
Total	40

**INSTRUCTIONS TO CANDIDATES**

Do not turn over this page until you are told to do so.

Follow all instructions carefully.

Answer all questions.

Write your answers in this booklet.

This booklet consists of 6 printed pages, excluding cover page.



**Booklet B (18 marks)**

For questions 12 to 17, write your answers in this booklet.

The number of marks available is shown in brackets [ ] at the end of each question or part question. (18 marks)

- 12 Yusri wanted to find out if overcrowding affects the growth of plants. The diagram below shows the seeds in pots X and Y before germination has taken place.

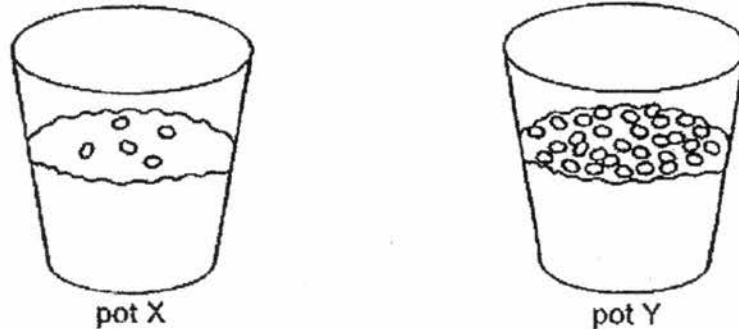

- (a) The table below shows the variables changed or kept constant throughout the experiment. Write 'changed' or 'kept constant' in the boxes provided. [1]

Variables		
(i)	Amount of soil used	
(ii)	Amount of water used	
(iii)	Number of seeds used	

One week later, Yusri observed and concluded that overcrowding affects the growth of the plants.

- (b) Explain why it is important for seeds to be dispersed far away from the parent plant. [2]

---

---

---

---

(Go on to the next page)

SCORE	3
-------	---

13 Study the dispersal of seeds by plants X and Y in the diagram below.

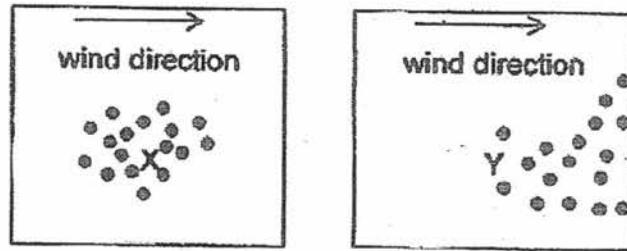

(a) Based on the diagram above, state the dispersal methods for the seeds [1]  
of plants X and Y.

(i) Plant X : Dispersed by \_\_\_\_\_

(ii) Plant Y : Dispersed by \_\_\_\_\_

The diagram below shows the fruit of a plant.



(b) State the dispersal method for the fruit above. [1]

\_\_\_\_\_

(c) Explain your answer in (b) [1]

\_\_\_\_\_

\_\_\_\_\_

(Go on to the next page)

SCORE	3
-------	---

14 The diagram below shows the family tree of James and his two siblings.

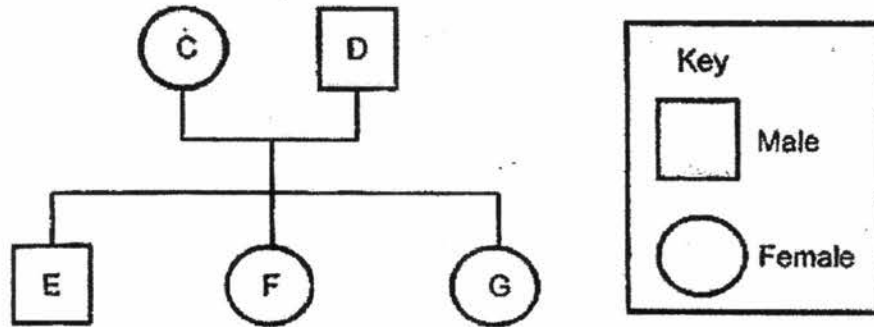

The table below shows the observable characteristics that are passed on to the members of his family. A tick (✓) in the box denotes the presence of the characteristics in that family member.

Family members	Characteristics		
	Attached earlobes	Single eyelids	Straight thumb
C		✓	
D	✓		✓
E	✓	✓	✓
F		✓	✓
G		✓	

(a) Based on the family tree, which letter, C, D, E, F or G, represents him? State the observable characteristic(s) which he has inherited from his father. [1]

---

(b) Based on the table above, write 'T' if the statement is true and 'F' if the statement is false in the boxes provided. [1]

(i)	The single eyelids characteristic is passed on only to females.	
(ii)	The attached earlobes characteristic is passed on only to males.	

(c) James told his siblings that he has inherited his interest in reading from his father. Do you agree with him? Why? [1]

---



---

(Go on to the next page)

SCORE	3
-------	---

15 Study the diagrams below.

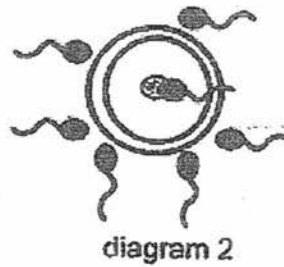
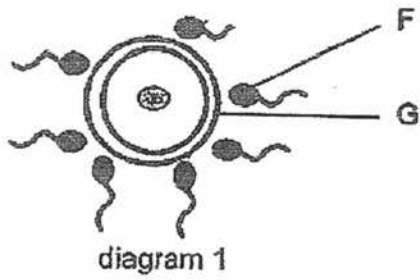

(a) Identify F and G in diagram 1.

[1]

F: \_\_\_\_\_

G: \_\_\_\_\_

(b) Name the process and state how it takes place in diagram 2.

[1]

\_\_\_\_\_

\_\_\_\_\_

(c) What happens after the process in diagram 2?

[1]

\_\_\_\_\_

\_\_\_\_\_

(Go on to the next page)

SCORE	3
-------	---

- 16 Lydia took out a cup of ice water from the refrigerator and left it on the table in a room of  $27^{\circ}\text{C}$  as shown in the diagram below.

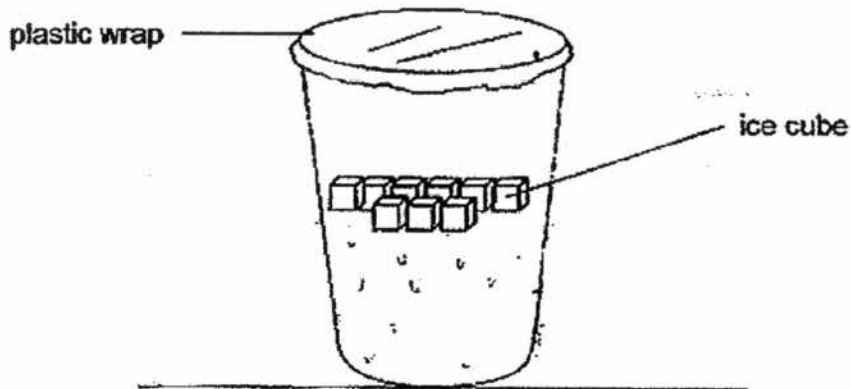

- (a) Draw water droplets on the diagram above to show where the droplets would be formed. [1]
- (b) What is the temperature of the ice cube when it is melting? [1]

---

(Go on to the next page)

SCORE	2
-------	---

- 17 Osher boiled a kettle of water and placed a frying pan near the sprout of the kettle as shown in the diagram below.

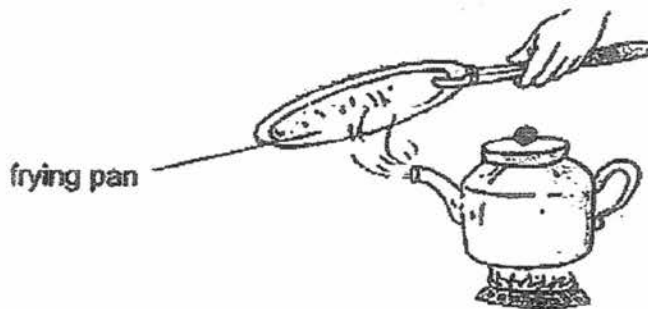

- (a) Name the substance formed on the frying pan. [1]

\_\_\_\_\_

- (b) If the kettle of water is boiled for some time, what would happen to the volume of the water in the kettle? [1]

\_\_\_\_\_  
\_\_\_\_\_

- (c) What is the temperature of the water in the kettle when it is boiling? [1]

\_\_\_\_\_

- (d) Write the change of state when water boils. [1]

From \_\_\_\_\_ state to \_\_\_\_\_ state

End of Booklet B

SCORE	4
-------	---

YEAR : 2017  
SCHOOL : CATHOLIC HIGH SCHOOL  
LEVEL : P5  
SUBJECT : SCIENCE  
TERM : CA1

Booklet A

Q1	3	Q2	2	Q3	4	Q4	3	Q5	1
Q6	4	Q7	2	Q8	2	Q9	1	Q10	4
Q11	1								

Booklet B

Q12 (a)

Amount of soil used	Keep constant
Amount of water used	Keep constant
Number of seeds used	Changed

- (b) Overcrowding will lead to competition of light, water, nutrients and space, so if they are not dispersed far away from the parent plant, the young plants will not grow healthily.
- Q13 (a) Plant X: Dispersed by explosive action  
Plant Y: Dispersed by wind
- (b) Water dispersal.
- (c) The fibrous husk traps small pockets of air which allows the fruit to float.

Q14 (a) E is James. He inherited attached earlobes and a straight thumb from his father.

(b)

The single eyelids characteristics is passed on only to females.	False
The attached earlobes characteristics is passed on only to males.	True

(c) No. Reading is not a characteristic that can be inherited from the parent.

Q15 (a) F : Sperm cell  
G : Egg cell

(b) Fertilisation. The male reproductive cell fuses with the female reproductive.

(c) The egg will be fertilised and starts to develop into a baby.

Q16 (a)

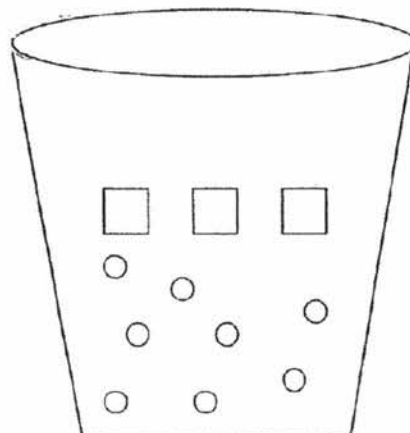

(b) 0°C



- Q17 (a) Water droplets.  
(b) The volume of water in the kettle will decrease  
(c) 100°C  
(d) liquid, solid