

ANGLO-CHINESE SCHOOL
(PRIMARY)

MID-YEAR EXAMINATION 2007

SCIENCE

BOOKLET A

Name: _____ ()

Class: Primary 5 _____

Date: 10th May 2007

Duration of paper: 1 h 45 min

**THIS BOOKLET CONTAINS 17 PAGES.
DO NOT OPEN THIS BOOKLET UNTIL YOU ARE TOLD TO DO SO.
FOLLOW ALL INSTRUCTIONS CAREFULLY.**

PART I

For each of the following questions from 1 to 30, four options are given. One of them is the correct answer. Make your choice (1, 2, 3 or 4). Shade the correct oval (1, 2, 3 or 4) on the Optical Answer Sheet.

(30 x 2 marks)

1 Which of the following classifications of the animals below is correct?

- A: Platypus
- B: Guppy
- C: Whale
- D: Dolphin

	Mammal	Fish	Lay Eggs
(1)	A only	B, C and D only	B only
(2)	A and D only	B and C only	C and D only
(3)	A, C and D only	B only	A and B only
(4)	A, C and D only	B only	A only

2 The table below shows the properties of three types of materials, A, B and C.

Properties	Material		
	A	B	C
Hard	✓	x	x
Flexible	x	✓	✓
- Strong	✓	✓	x

Based on the information above, which one of the following would A, B and C most likely be?

	A	B	C
(1)	Metal ruler	Cotton thread	Fishing line
(2)	Fishing line	Cotton thread	Metal ruler
(3)	Fishing line	Metal ruler	Cotton thread
(4)	Metal ruler	Fishing line	Cotton thread

83 $\frac{1}{10}$

- 3 Sara looked at the picture shown below and made four statements A, B C and D about the goat.

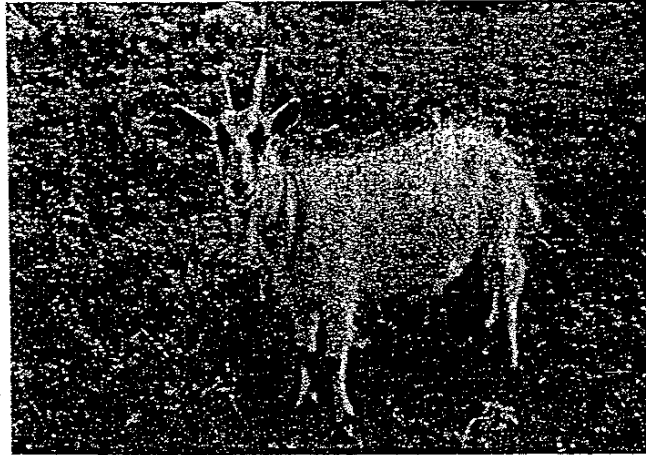

- | | |
|----|--------------------------------------|
| A: | The goat is eating grass. |
| B: | The goat has escaped from its owner. |
| C: | The goat is standing on the grass. |
| D: | Someone has brought the goat there. |

Based on her observation only, which of the statement(s) is/are true or not possible to tell?

	True	Not possible to tell
(1)	C only	A, B and D only
(2)	A and D only	B and C only
(3)	B, C and D only	A only
(4)	A, B C and D	-

- 4 The classification table below groups some things according to their characteristics/properties.

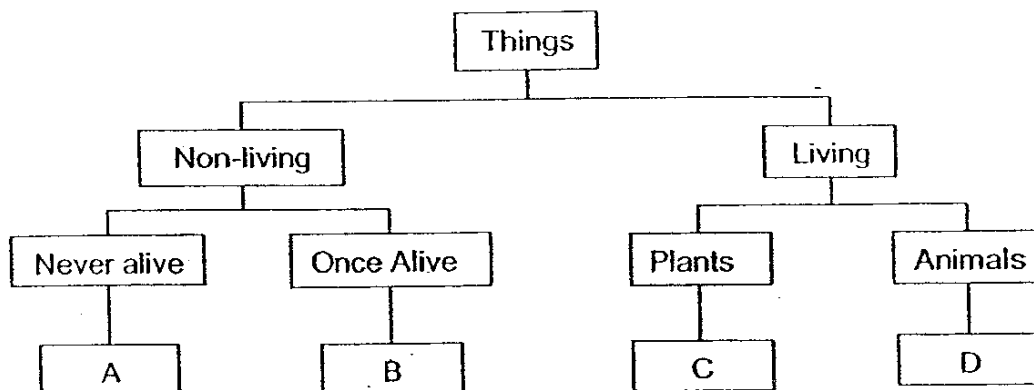

Which of the following correctly identifies A, B, C and D?

	A	B	C	D
(1)	Iron nail	Book	Balsam	Venus flytrap
(2)	Plastic ruler	Book	Venus flytrap	Snail
(3)	Plastic ruler	Wooden chair	Mushroom	Snail
(4)	Iron nail	Wooden chair	Moss	Venus flytrap

- 5 Which of the following are likely reasons for a drink stall owner to sell drinks in plastic cups?

- A: Plastic cup is waterproof.
- B: Plastic cup scratches easily.
- C: Plastic cup does not break easily.
- D: Plastic cup is flexible.

- (1) A and C only
- (2) A and D only
- (3) B and C only
- (4) B and D only

85

- 6 The pie chart below shows the number of different types of plants in percentages in two schools, A and B.

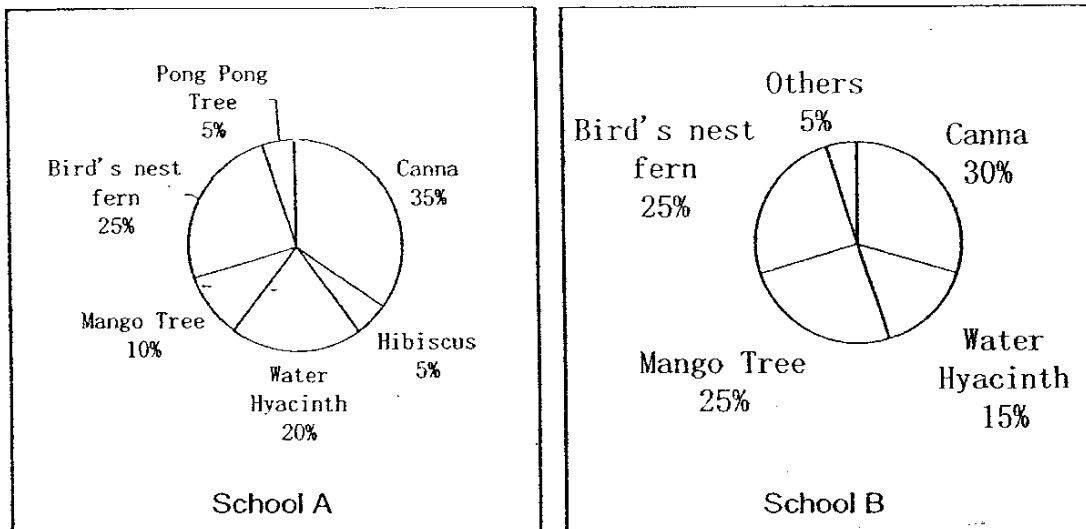

John studied the charts and made the following statements:

- A. There are more Canna plants in School A than in School B.
- B. The percentage of Mango Trees in School A is less than that in School B.
- C. School A has more variety of plants than School B.
- D. There are more Bird's Nest Fern than Water Hyacinth in School B.

Which of his following statements are true?

- (1) D only
- (2) B and D only
- (3) A, B and C only
- (4) A, B, C and D

- 7 Timothy left three blocks of glass in three Rooms A, B and C of different temperatures for an hour. Thereafter, they are removed and left in Room D. After 5 minutes, he noticed water droplets on the block from Room A but not from Room B or C.

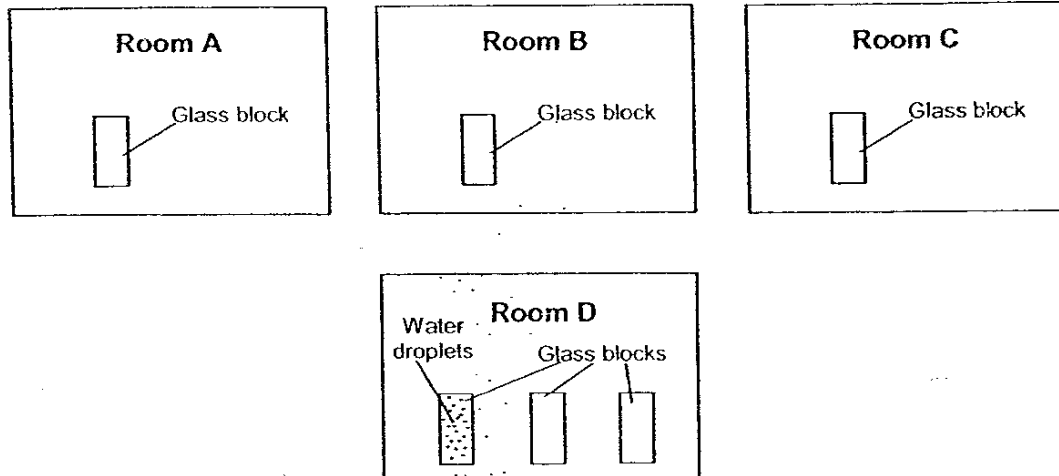

Which statement best describes the temperature of the room(s)?

- (1) Room A is the coldest room.
 - (2) Room B and C are at the same temperature as Room D.
 - (3) Room D is the warmest room.
 - (4) Room B and C are the warmest room.
- 8 Which of the following statements is true about the Sun?

- (1) It is a very hot solid object.
- (2) It has planets revolving around it.
- (3) It is one of the stars in our solar system.
- (4) It is smaller than planet Earth.

- 9 John attaches two identical deflated balloons at each end of a rod. He ties a string at the centre of the rod and it balances as shown in the diagram below.

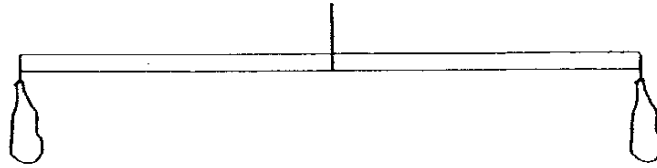

He then inflates one of the balloons and the rod now tilts to the right as shown in the diagram below.

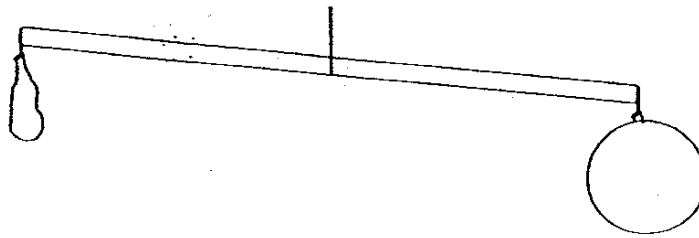

What can he conclude from his experiment?

- (1) Air has mass.
 - (2) Air can be compressed.
 - (3) Air has no definite shape.
 - (4) The mass of the balloon depends on its shape.
- 10 One of the reasons that the Earth is able to support a diversity of life is because it _____.
- (1) is the planet nearest to the Sun
 - (2) reflects sunlight to the Moon
 - (3) takes 24 hours to make one rotation about its axis
 - (4) has an atmosphere that is appropriate for living things to survive

- 11 John looked up into the sky one night and noticed the shape of the moon. The photograph below shows the moon that he observed.

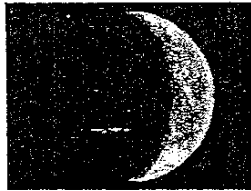

After 2 weeks, which of the following phases of the moon (1, 2, 3 or 4) will he see?

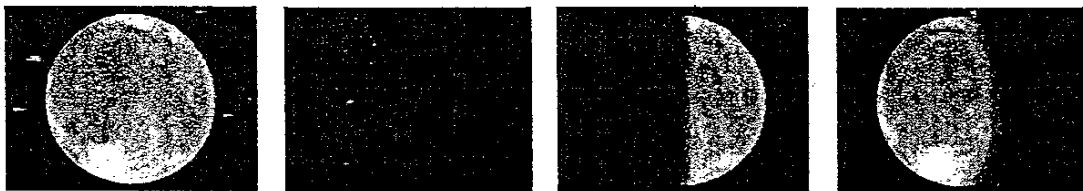

(1)

(2)

(3)

(4)

- 12 The diagram below shows the three properties of substance X.

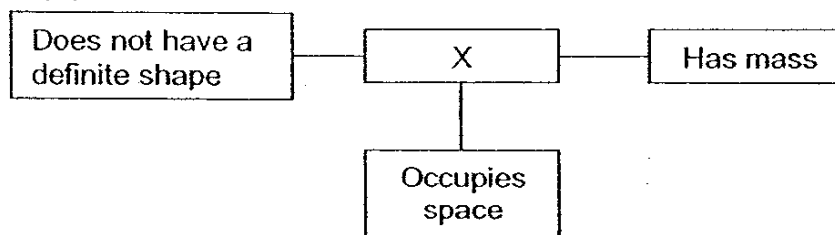

Substance X could be _____

- (1) milk or ice.
- (2) sound or oxygen.
- (3) water or nitrogen.
- (4) rubber band or nitrogen.

89

- 13 The table below shows some facts about the planets W, X, Y and Z in the solar system.

Planet	Length of Day (Earth hours)	Length of Year (Earth days)
W	11	10756
X	5832	225
Y	25	687
Z	10	4330

Which statement about these four planets is true?

- (1) Planet Z rotates the slowest about its axis.
 - (2) Planet X is the furthest planet from the Sun.
 - (3) Planet X is nearer to Planet Y than to Planet W.
 - (4) Planet W takes the shortest time to make one revolution around the Sun.
- 14 Boon Wee looked through a microscope to study the structure of a cell. He made a drawing of the cell as shown below.

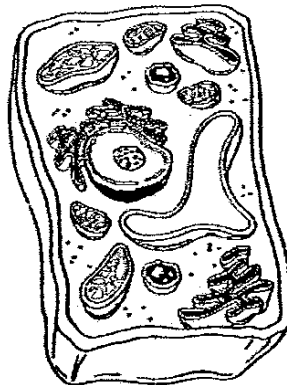

Which of the following statements about the cell is true?

- (1) It is an animal cell as it has a nucleus.
- (2) It is an animal cell as it has irregular shape.
- (3) It is a plant cell as it has cell wall.
- (4) It is a plant cell as it has a thick cell membrane.

15 In the flowchart below, A, B and C represent 3 different organisms.

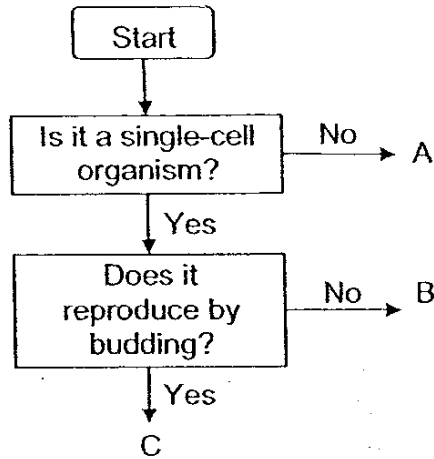

Which of the following options is true of organism A, B and C?

	A	B	C
(1)	Amoeba	Cheek Cell	Yeast
(2)	Cheek Cell	Amoeba	Yeast
(3)	Yeast	Amoeba	Cheek Cell
(4)	Cheek Cell	Yeast	Amoeba

16 Which of the following about the male reproductive cell in the human body are correct?

- A It has a nucleus.
- B It is produced in the penis.
- C It is the largest cell in the human body.
- D It fuses with an egg during fertilisation.

- (1) A and D only
- (2) A and C only
- (3) A, B and D only
- (4) B, C and D only

17 Which of the following statements about reproduction in animals are correct?

- A Sperms are produced by male animals.
- B Usually one egg is fertilised by many sperms.
- C After fertilisation, the eggs will develop into young animals.
- D Fertilisation only takes place inside the body of female animals.

- (1) A and B only
- (2) A and C only
- (3) B and D only
- (4) A, C and D only

18 The diagram below shows a family tree.

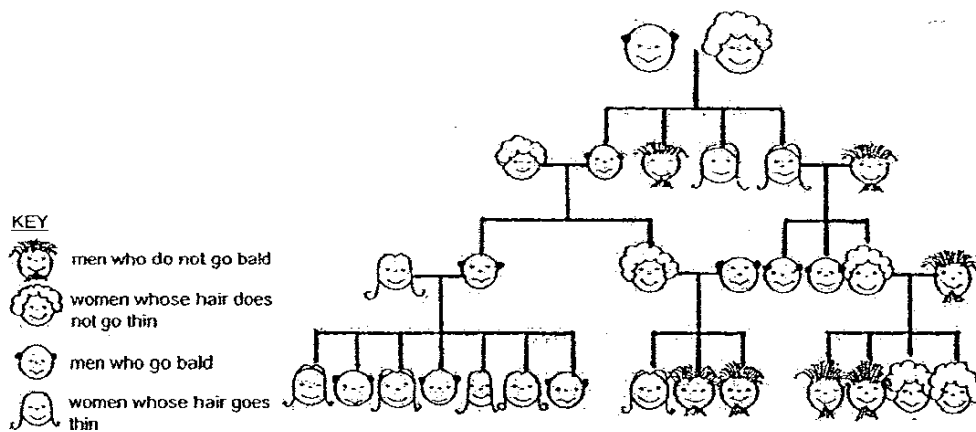

Based on the above family tree, which one of the following can be inferred?

- (1) If the father of a family is bald, his son(s) will be bald.
- (2) Women whose hair goes thin will produce sons who will go bald.
- (3) Women whose hair goes thin are able to produce more children.
- (4) Fathers with bald heads will produce daughters with hair that will go thin.

- 19 Rahim wanted to carry out an experiment to find out how the length of the wing-like structure of a fruit affects the distance it travelled. He used three similar shorea fruits. Shorea fruit A was left intact. Shorea fruit B and C had their wing-like structures cut away as shown in the diagram.

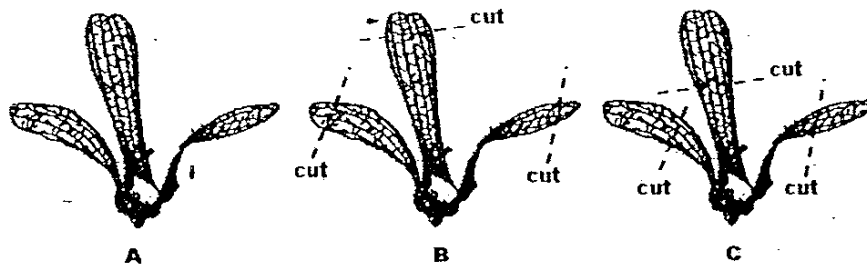

Each of the three fruits was then released in front of a fan as shown in the diagram below.

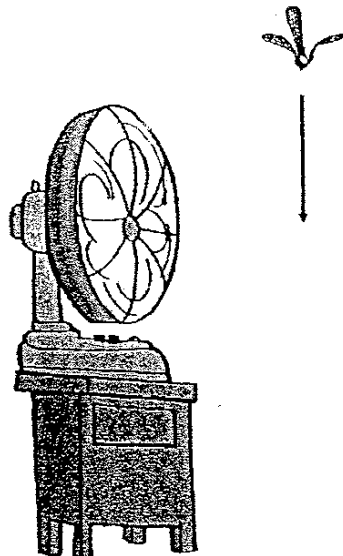

Which of the following observations did Rahim have to record for his experiment?

- (1) Mass of each shorea fruit.
- (2) Height at which the shorea fruit was dropped.
- (3) Time taken for the shorea fruit to stay in the air.
- (4) Distance between the starting point and the landing point of the fruit.

20 Keith wanted to test if bees are attracted to the colour of flowers. Which of the following pairs of flowers should he use for his test?

(1)

white
daisy with
nectar

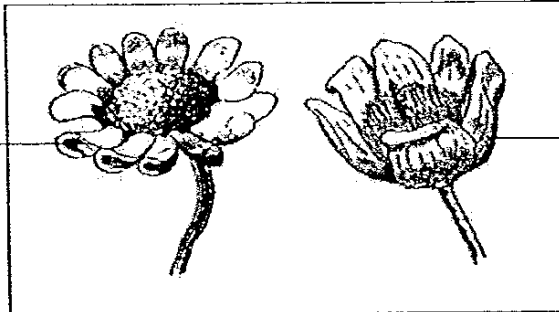

white tulip
with no
nectar

(2)

red daisy
with
nectar

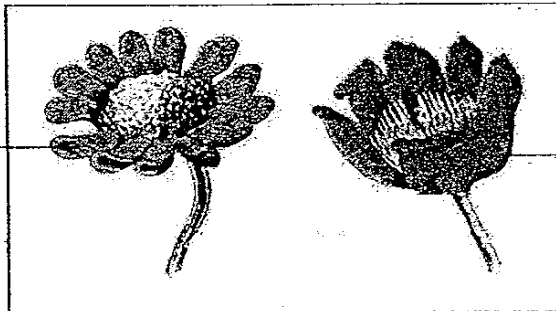

red tulip
with
nectar

(3)

white tulip
with no
nectar

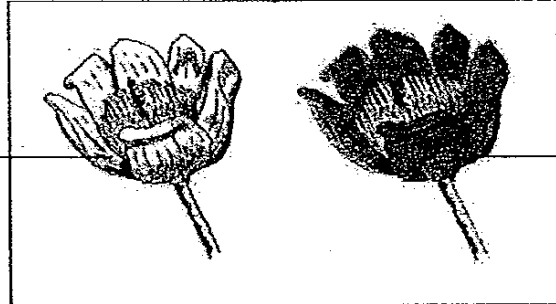

red tulip
with
nectar

(4)

white
daisy with
no nectar

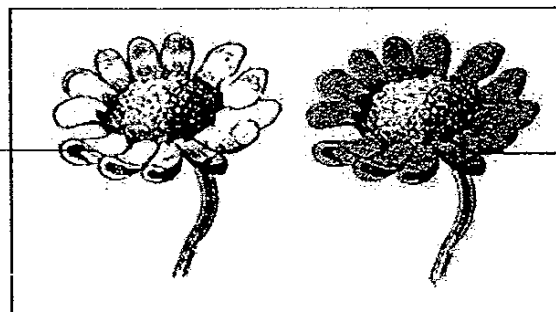

red daisy
with no
nectar

21 The diagram below shows two different flowers.

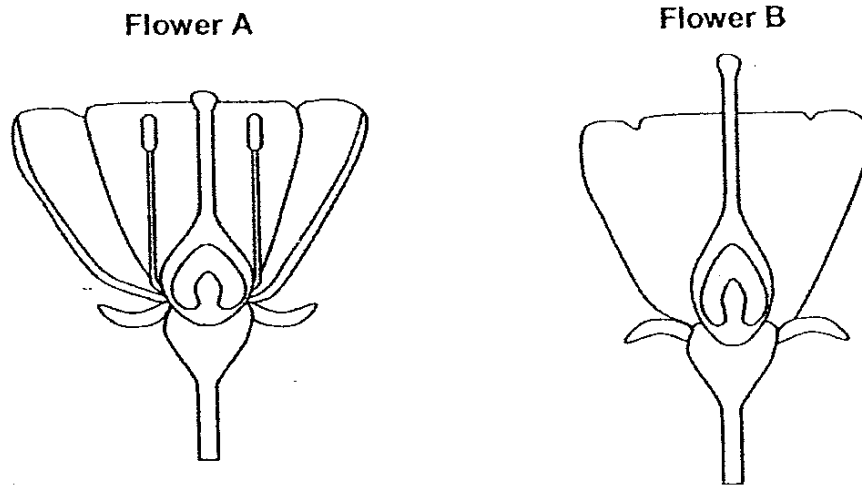

Which one of the following statements about flowers A and B is false?

- (1) Only flower A has anthers.
- (2) Both flowers have an ovary each.
- (3) Both flowers cannot grow into fruits.
- (4) Pollination can take place in both flowers.

22 Edward classified some of the fruits and seeds in the table below.

P	Q
Shorea	Papaya
Lalang	Rambutan

Which of the following fruits or seeds would Edward place under P and Q?

	P	Q
(1)	Cherry	Coconut
(2)	Nipah	Lovegrass
(3)	African Tulip	Balsam
(4)	Angsana	Mimosa

23 The diagram below shows a potato plant.

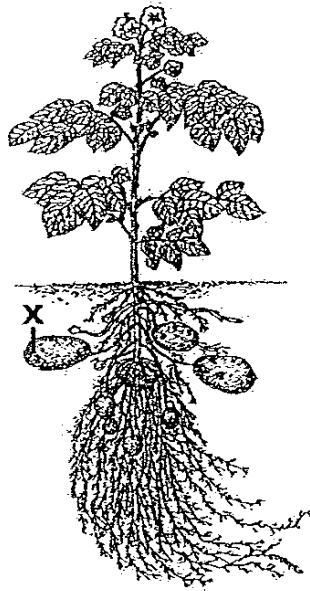

What is/are the function(s) of the part marked X?

- A To store food for the plant
- B To take in water for the plant
- C To hold the plant firmly to the ground

- (1) A only
- (2) A and C only
- (3) B and C only
- (4) A, B and C

24 In what way is sexual reproduction similar in plants and animals?

- (1) Fertilisation takes place in the ovary.
- (2) Both plants and animals require male and female sex cells.
- (3) The eggs are released from the ovules in both plants and animals.
- (4) The nucleus in pollen grain fuses with the egg in both plants and animals.

- 25 Richard had two aquariums, A and B, each containing a different type of plant as shown in the diagrams below. Both aquariums were left under a light source for ten hours. The amount of dissolved oxygen in each aquarium was measured at the start of the experiment and at the end.

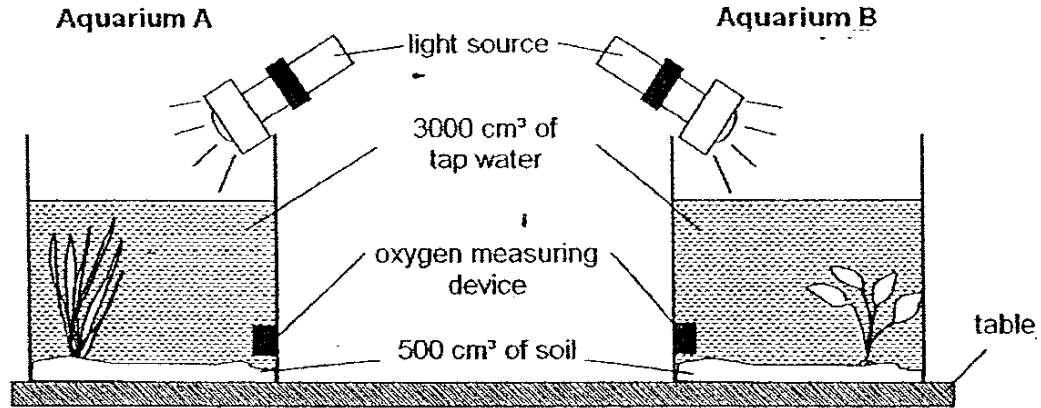

What was the aim of the experiment?

- (1) To find out how does the light affects the rate of photosynthesis.
 - (2) To find out whether carbon dioxide is given out during photosynthesis.
 - (3) To find out whether one plant has a faster rate of photosynthesis than the other.
 - (4) To find out how the different amount of dissolved oxygen affects the rate of photosynthesis.
- 26 Which of the following shows the correct sequence of reproduction of a flowering plant?

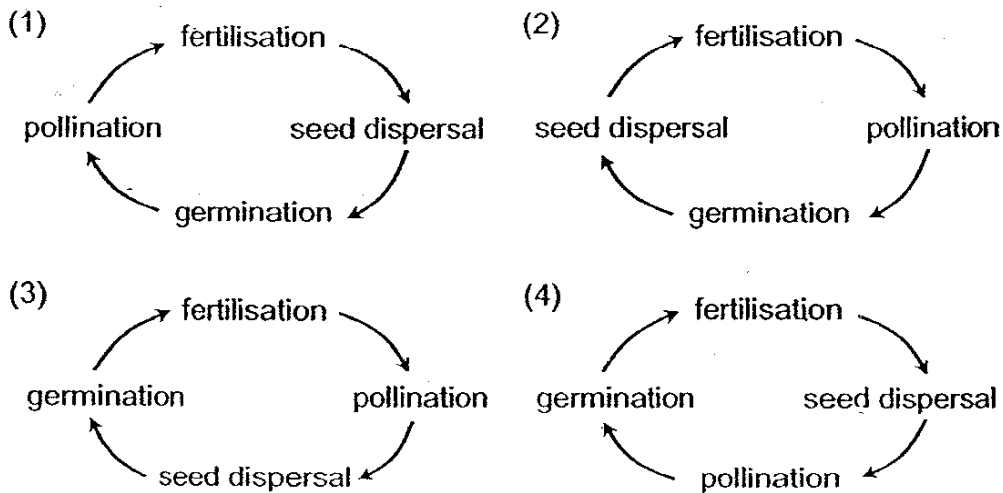

- 27 Ravi poured 350cm^3 of water into each of the four glass containers. The containers were left in the open with their top exposed. Which of the containers below would have the least amount of water left after a few hours?

(1)

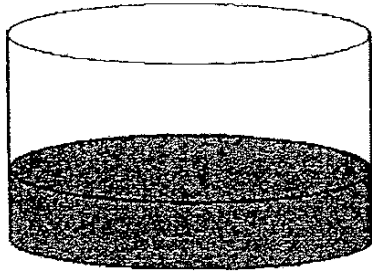

(2)

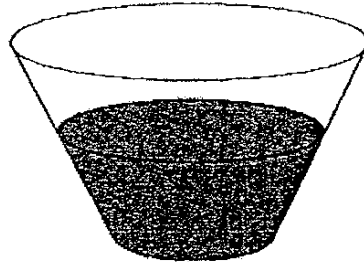

(3)



(4)

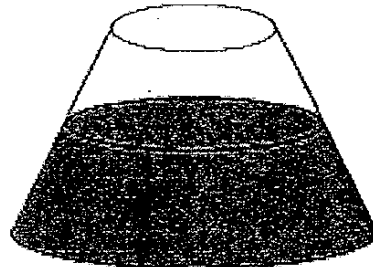

- 28 Which of the following statement(s) about exhaled air is/are correct?

- A It has more carbon dioxide than oxygen.
- B It has less water vapour than inhaled air.
- C It is usually warmer than the surrounding air.

- (1) C only
- (2) A and B only
- (3) A and C only
- (4) A, B and C only

- 29 John was studying the rate of cooling of warm water. He left a beaker of warm water in a room for two hours. Which of the following graphs shows the correct temperature change?

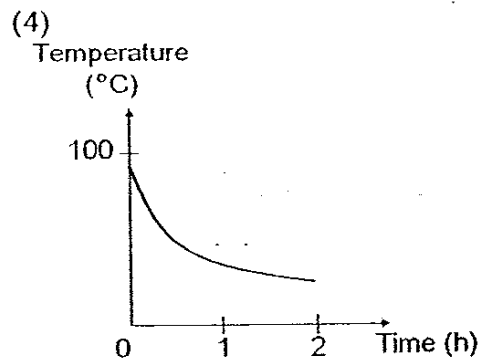
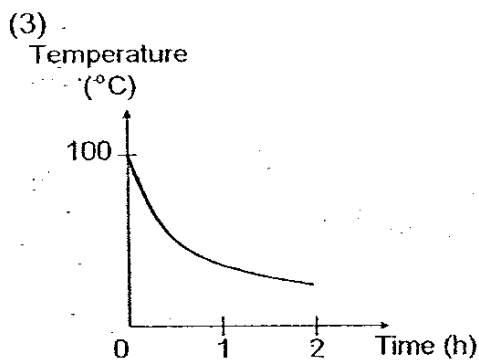
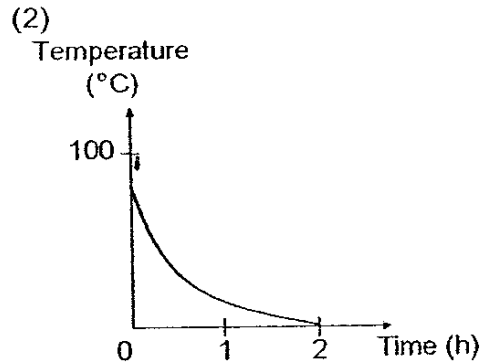
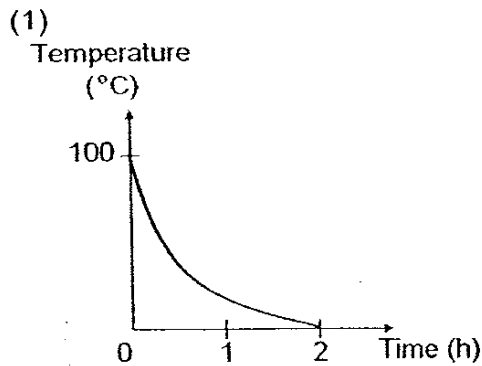

- 30 Jonathan cut a fruit and observed that it contained many seeds. Which one of the following inferences is best supported by Jonathan's observation?

- (1) Only one pollen grain fertilised the flower.
- (2) The flower that produced this fruit grew in bunches.
- (3) There were many ovules present in the flower's ovary.
- (4) The anthers of flower produced many pollen grains.

ANGLO-CHINESE SCHOOL
(PRIMARY)

MID-YEAR EXAMINATION 2007

SCIENCE

BOOKLET B

Name: _____ ()

Class: Primary 5 _____

Date: 10th May 2007

Duration of paper: 1 h 45 min

Parent's Signature

Booklet	Maximum marks	Marks obtained
A	60	
B	40	
Total	100	

THIS BOOKLET CONTAINS 11 PAGES.
DO NOT OPEN THIS BOOKLET UNTIL YOU ARE TOLD TO DO SO.
FOLLOW ALL INSTRUCTIONS CAREFULLY.

PART II

For questions 31 to 46, write your answers in this booklet.

The number of marks available is shown in brackets [] at the end of each question or part question.

(40 marks)

31 The diagram below shows the direction of the Sun's rays shining on the Earth.

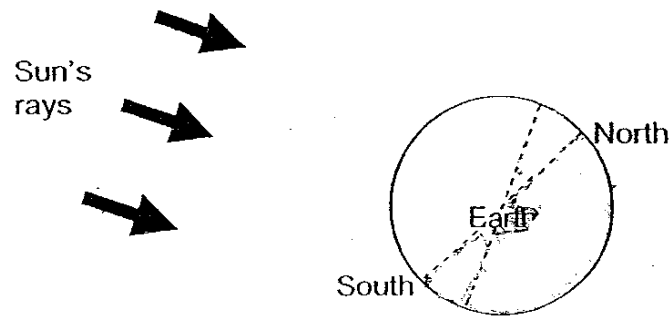

(a) On the above diagram, shade the region of the Earth that experiences night time.

[1]

(b) The diagram below shows a satellite launched into space to study a region X on Earth.

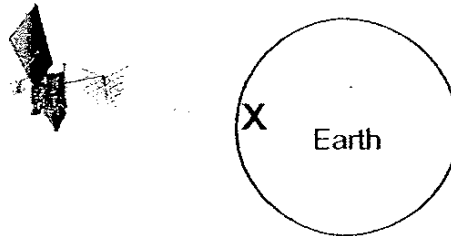

In order for the satellite to study region X all the time, explain how the satellite should move in terms of its revolution around the Earth with respect to the Earth's rotation?

[1]

32 The photographs below show a cell undergoing a process.

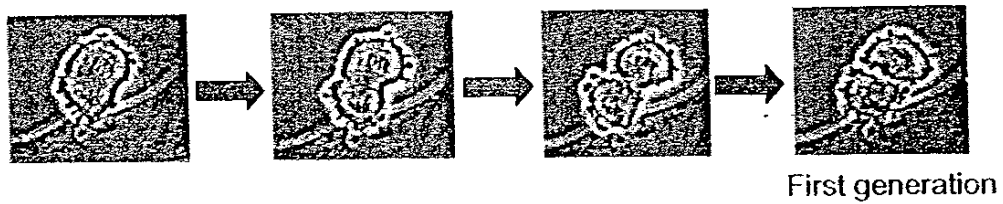

- (a) What process is the cell undergoing? [1]
-
- (b) State one reason why it is necessary for cells to go through this process. [1]
-
- (c) How many cells will there be in the second generation? [1]
-

33 Study the classification chart carefully.

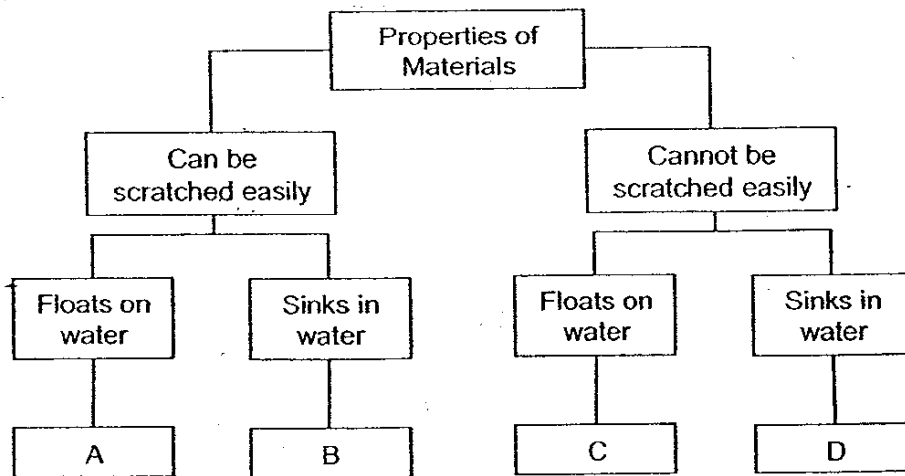

- (a) What are the characteristics of object A? [1]
-
- (b) In the diagram, the letter _____ represents an iron nail. [1]

602

- 34 Jason took a glass of ice cubes from the freezer and heated the ice cubes until boiling occurred. He turned off the fire and left the contents in the glass to cool to room temperature. He measured the temperature of the contents in the glass at 2-minute intervals for 40 minutes and plotted the graph as shown below.

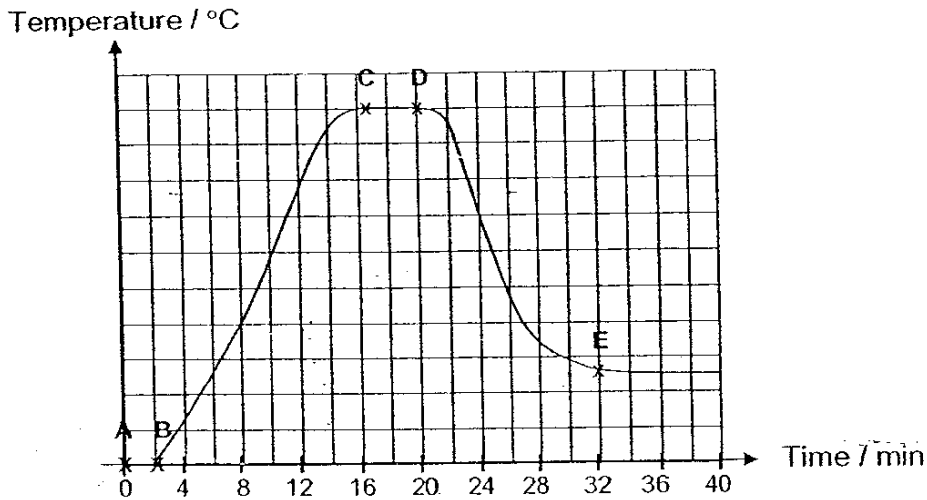

- (a) From the graph, determine the room temperature. [1]

- (b) Heat is continuously being transferred between the contents in the glass and its surroundings during the 40 minutes. Determine the overall heat exchange at each of these sections of the graph: AB, BC, CD and DE. Tick (✓) the appropriate boxes in the table below. [2]

	Heat lost	Heat gained	Heat is neither lost or gained
AB			
BC			
CD			
DE			

103

- 35 David fully filled up three identical syringes A, B and C with three different substances.

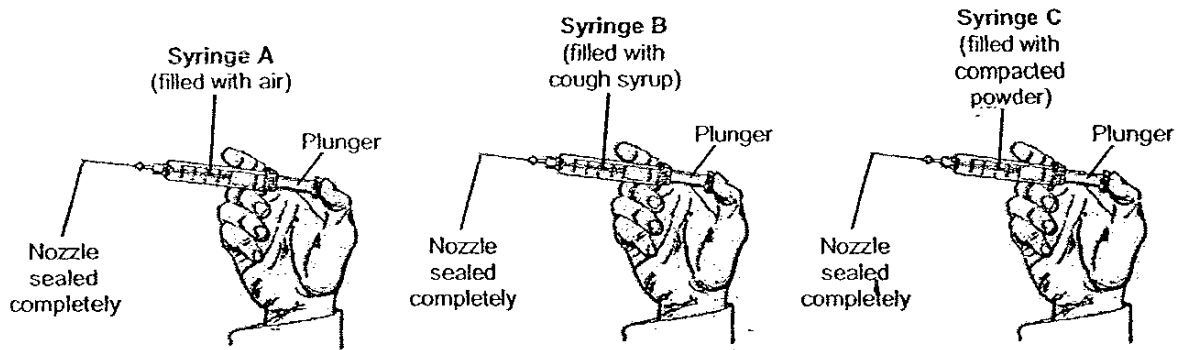

The nozzles of the syringes were sealed completely. He then tried to push the syringe's plunger inwards as far as he could.

- (a) Why should the nozzles of the syringes be sealed completely? [1]

- (b) Which plunger (A, B or C) can be pushed in easily? [1]

- (c) Explain your answer to part (b). [1]

- 36 Fill in each blank with a suitable word.

The Solar System is made up of the _____, the Moon, the [2]
Earth and other _____. The Moon is a natural
_____ of the Earth. One of the reasons why living things
can survive on Earth is due to its _____ from the
Sun.

- 37 The following graph shows the amount of rainfall over a period of 12 months in a certain place.

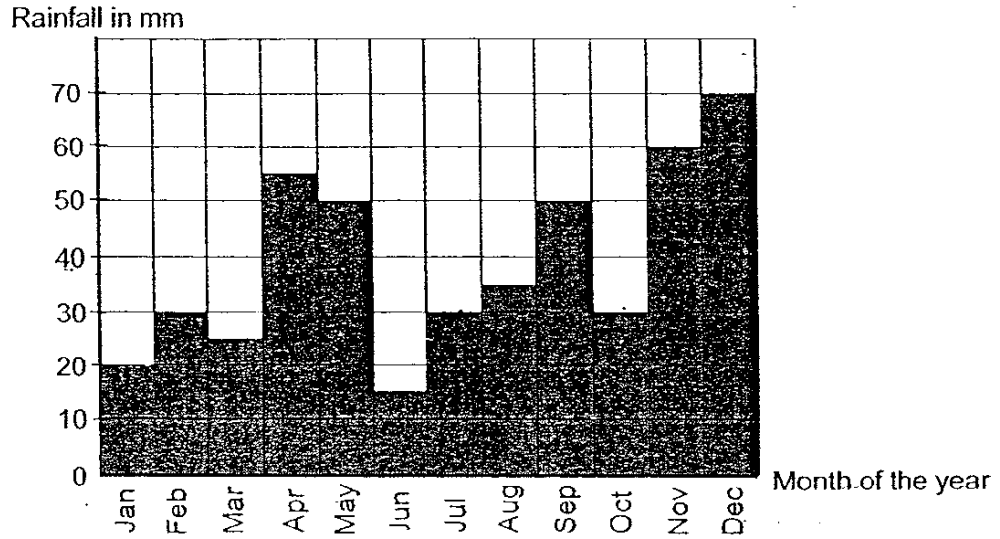

Put a tick (✓) in the appropriate column against each of the statements below. [2]

	True	False	Not possible to tell
(a) June is the driest month of the year.			
(b) The wettest day of the year falls in December.			
(c) The amount of rainfall is the same for three of the months.			
(d) The first half of the year is wetter than the second half.			

105

38 Samuel conducted an experiment and the procedures are shown below.

- Step 1: Obtain three different kinds of bread of the same size:
- i. Chocolate flavoured bread
 - ii. Milk bread
 - iii. Wheat bread
- Step 2: Place all three pieces of bread in three different corners of the same room.
- Step 3:
- Shine a very bright table lamp on the chocolate flavoured bread.
 - Shine a very dim table lamp on the milk bread.
 - Do not shine any light on the wheat bread.
- Step 4: Switch off the ceiling light in the room (leaving only both table lamps switched on).
- Step 5: Examine the bread after ten days.

At the end of the experiment, he found that the wheat bread had the most amount of mould growing on it. He concluded that the amount of light affected the rate of growth of mould on bread.

(a) Explain why this experiment was not a fair one. [1]

(b) What is the aim of the experiment? [1]

(c) Name one factor that was kept constant during the experiment. [1]

39 The diagram below shows part of the water cycle.

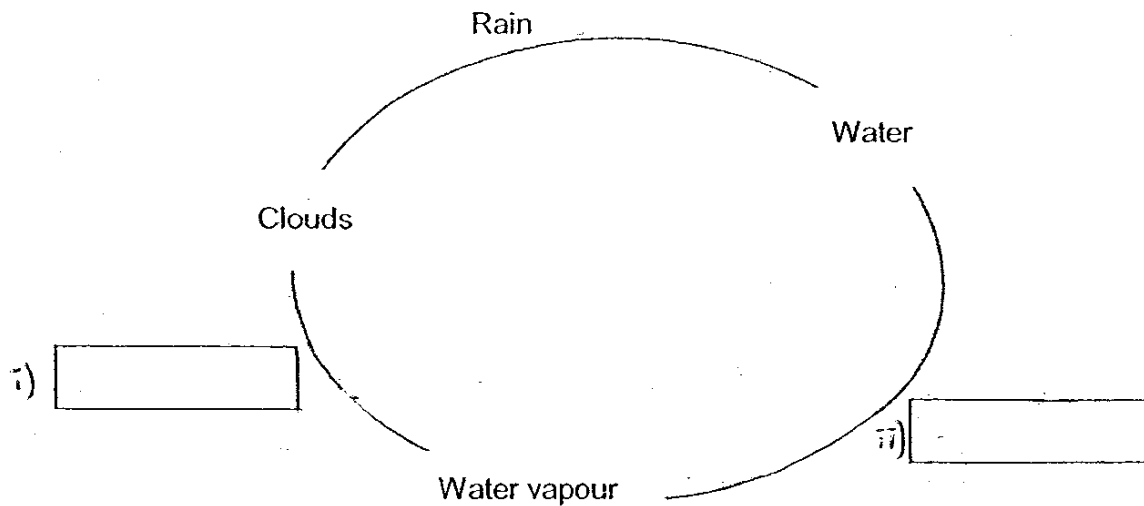

- (a) Draw in the missing arrow heads (\rightarrow) to show the correct order of the water cycle. [1]
- (b) Name the missing processes in the water cycle in the boxes provided. [2]

40 The diagrams below show the male and female human reproductive systems.

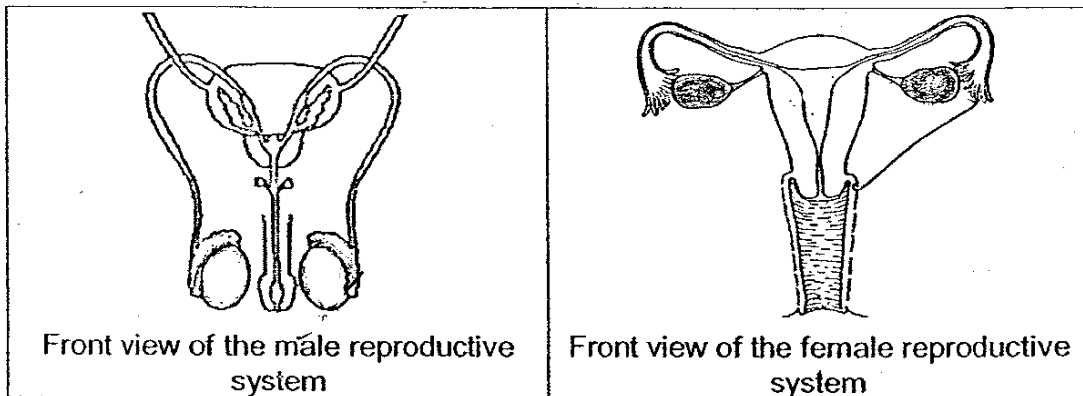

- (a) On each of the diagram, shade the parts that produce the reproductive cells. [2]
- (b) On the correct diagram, mark a cross 'X' at the place where a young develops. [1]

107

- 41 Mei Wen wanted to find out whether plants take in oxygen and give out carbon dioxide during respiration. She covered a potted plant with a black cardboard box as shown below and left the setup aside for ten hours.

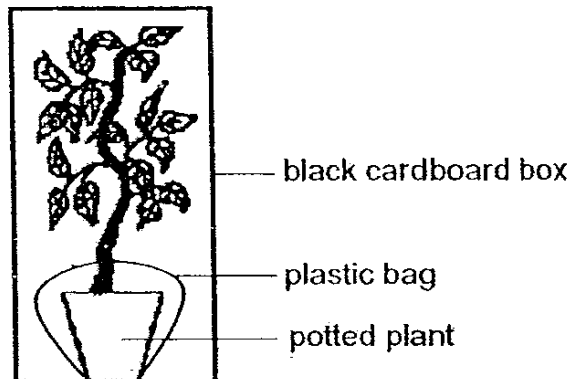

The table below shows the percentage of the different gases in the box which she had taken at two different times of the experiment.

Type of gas	Percentage of gases measured	
	At start of experiment	At end of experiment
Oxygen	21%	18%
Nitrogen	78%	78%
Carbon dioxide	0.5%	3.5%

- (a) What can Mei Wen conclude from her experiment?

[1]

- (b) If Mei Wen were to set up a control experiment, put a tick (✓) in the appropriate column to indicate if she requires the variables listed below for the experiment.

[2]

Variable	Yes	No
i) Plant		
ii) Soil		
iii) Pot covered with plastic bag		
iv) Black cardboard box		

42 Below are four methods (A, B, C and D) of water conservation.

A	Do not build factories near reservoirs.
B	Repair any tap water leakage immediately.
C	Treat sewage water before discharging it into rivers and seas.
D	Recycle water for uses such as flushing and cleaning toilets.

The graphic organiser below classifies these methods of water conservation into two groups. Complete the organizer by filling in the bubbles with the letters A, B, C and D. [2]

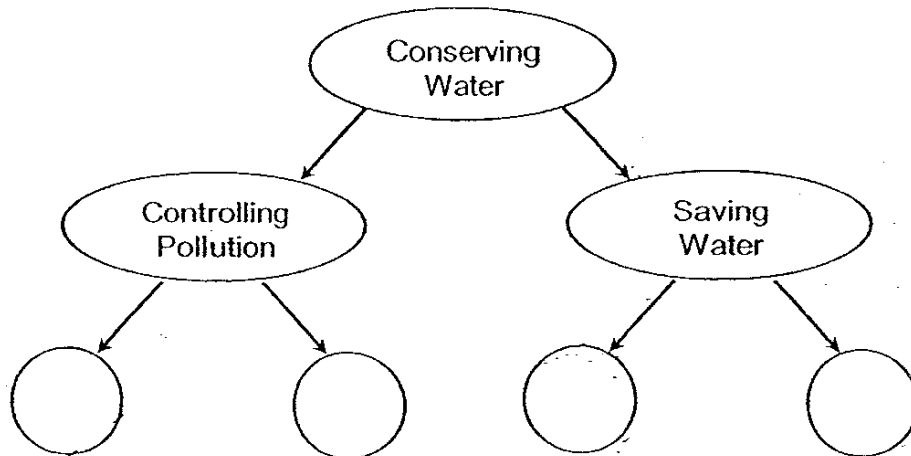

43 Study the living organisms shown below.

Bread mould	Moss	Stag horn's fern	Mushroom
------------------------	-----------------	-----------------------------	---------------------

(a) Classify the living organisms into two groups, A and B, such that there are two organisms in each group. [1]

Group A	Group B

(b) Explain how you have classified the living organisms. [1]

109

44 There was only one adult banana plant growing in Mr Ng's garden. A few months later, Mr Ng noticed that a young banana plant has grown beside the adult plant even though he did not plant it. No bananas have grown on the adult tree so far.

(a) Explain how the young banana plant managed to grow in the garden even though no one planted it. [1]

(b) Mr Ng observed that the adult banana plant died after a few weeks. How will the death of the adult banana plant be advantageous to the young banana plant? [1]

45 The diagram below shows a container that has collected some rain water over a few days.

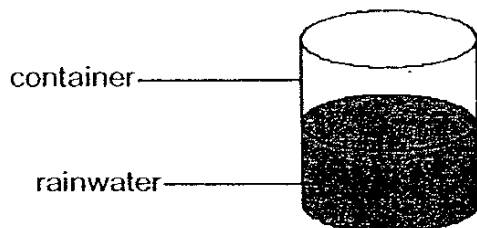

The container was covered with a lid and a week later, mosquitoes can be found inside the beaker as shown below.

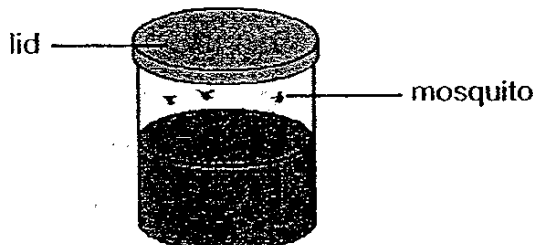

How do you think the mosquitoes got in the beaker if the lid was not removed at all? [2]

*

- 46 Joshua carried out an experiment on the germination of a red bean plant as shown below.

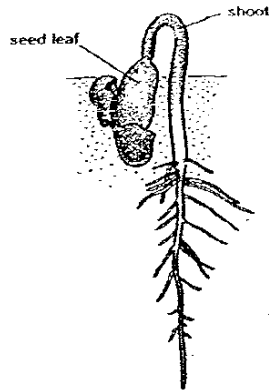

He plotted a graph to show changes in the mass of the seed leaf and the shoot over a period of eight days as shown below.

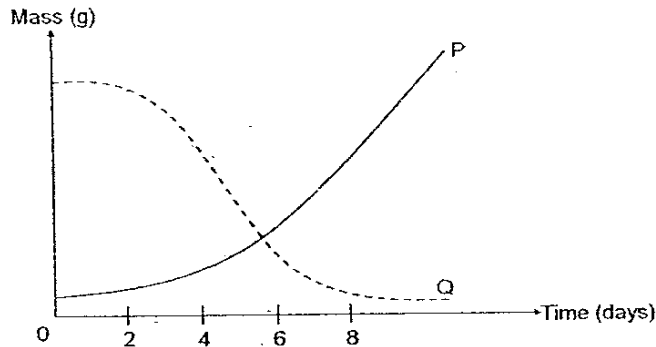

- (a) Which curve, P or Q, shows how the mass of the seed leaf changes during the experiment? [1]

- (b) What would happen to the shoot if there were no sunlight for the first eight days? [1]

- (c) How did the shoot get its food from the eighth day onwards? [1]

End of Paper

ACS Primary School

Primary 5 Science SA1 Exams (2007)

Answer Keys

SECTION A : (60 MARKS)

Qn no.	Ans
1	4
2	4
3	1
4	2
5	1
6	4
7	1
8	2
9	1
10	4

Qn no.	Ans
11	4
12	3
13	3
14	3
15	2
16	1
17	2
18	2
19	4
20	4

Qn no.	Ans
21	3
22	4
23	2
24	2
25	3
26	1
27	1
28	1
29	4
30	3

SECTION B (40 MARKS)

31a.

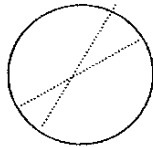

31b. The satellite should revolve around the Earth faster than the Earth's rotation.

32a. Cell division.

32b. It is to replace old and damage cells.

32c. 4 cells.

33a. Object A can be scratched easily and it floats on water.

33b. D

34a. 25° C

34b. AB = Heat gained

BC = Heat gained

CD = Heat gained

DE = Heat lost

35a. To prevent the substances from coming out.

35b. Plunger A.

35c. Air can be compressed.

36. Sun, planets, satellite, distance.

- 37a. True
- 37b. Not
- 37c. True
- 37d. False

- 38a. The type of bread used is different.
- 38b. To find out if bread without light or bread with light has most mould.
- 38c. Temperature/Humidity

- 39(i) Condensation
- 39(ii) Evaporation

40a

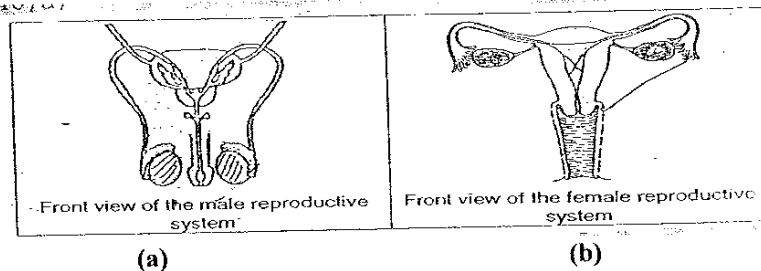

- 41a Plants take in carbon dioxide and give out oxygen.
- 41b(i) No
- (ii) Yes
- (iii) Yes
- (iv) Yes

42. A,C,D,B

43a. Group A = Moss, stag horn's fern
Group B = Mushroom, Bread mould

43b. Organisms in Group A are plants but organisms in Group B are fungi.

44a. The dispersal from the adult plant.

44b. The adult banana plant and the young banana plant are fighting for sunlight and water.

45. When it rains the mosquitoes breed in the container, so the mosquitoes are in the container, even though the lid was not removed.

46a. Curve Q

46b. The shoot would continue to germinate.

46c. It will have leaves for the plants to photosynthesize.