



RAFFLES GIRLS' PRIMARY SCHOOL  
SEMESTRAL ASSESSMENT 1  
2014

Section A	60
Section B	40
Your score out of 100 marks	
Parent's signature	

Name : \_\_\_\_\_ Index No: \_\_\_\_\_ Class: P5 \_\_\_\_\_

6 May 2013

SCIENCE

Att: 1 h 45 min

SECTION A (30 x 2 marks)

For each question from 1 to 30, four options are given. One of them is the correct answer. Make your choice (1, 2, 3 or 4). Shade the correct oval (1, 2, 3 or 4) on the Optical Answer Sheet (OAS) provided.

1. Wan Qi placed two mice in an air-tight container as shown below. The diagrams are not drawn to scale.

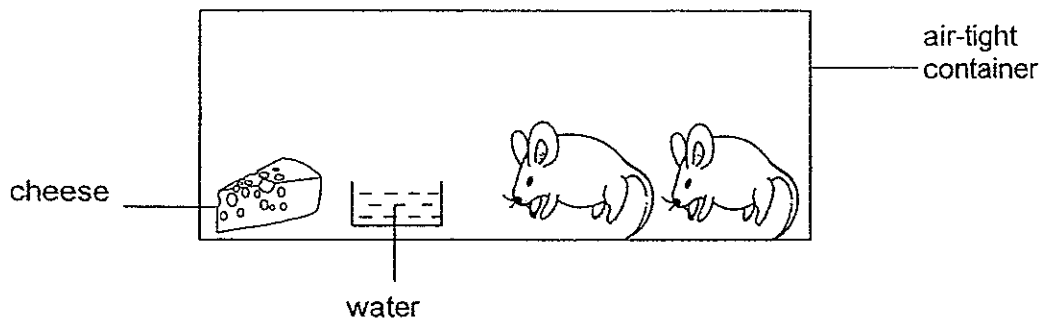

She observed that the mice died after a week.  
Based on the experiment above, what could she conclude about living things?

- (1) Living things grow.
- (2) Living things reproduce.
- (3) Living things need air to survive.
- (4) Living things respond to changes around them.

2. Muthu classified the whale as a mammal. Which of the following statement(s) describe(s) the characteristics of all mammals?

- A It feeds on its mother's milk.
- B It reproduces by laying eggs.
- C It uses its fins to swim in water.
- D It has scales to protect its body.

- (1) A only
- (2) A and B only
- (3) B and C only
- (4) C and D only

3. Glenn classified four animals, chicken, butterfly, grasshopper and platypus using the flow chart below.

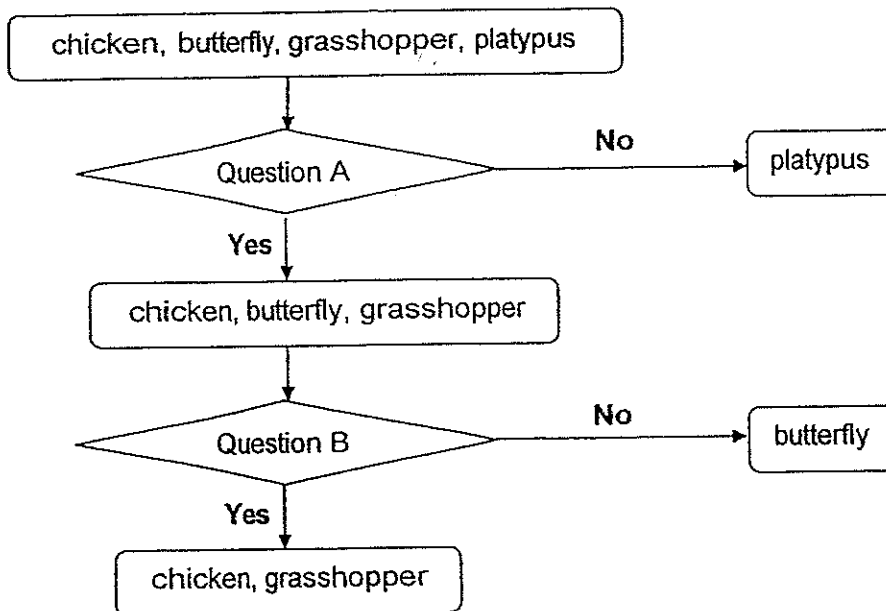

Which one of the following represents questions A and B respectively?

	Question A	Question B
(1)	Do they have wings?	Do they lay eggs?
(2)	Do they lay eggs?	Do they have wings?
(3)	Do they have wings?	Do they have a 3-stage life cycle?
(4)	Do they lay eggs?	Do they have a 3-stage life cycle?

4. What is generally common among flowering and non-flowering plants?

- (1) They reproduce by seeds.
- (2) They reproduce by spores.
- (3) They are able to make their own food.
- (4) They are able to move from place to place.

5. Which of the following statement(s) about micro-organisms is/are **incorrect**?

- A All micro-organisms are harmful to us.
- B All micro-organisms can make their own food.
- C Micro-organisms are found in yoghurt and kimchi.
- D Micro-organisms can be seen with the help of a microscope.

- (1) A only
- (2) B only
- (3) A and B only
- (4) A, C and D only

6. The diagrams below show two life cycles, A and B.

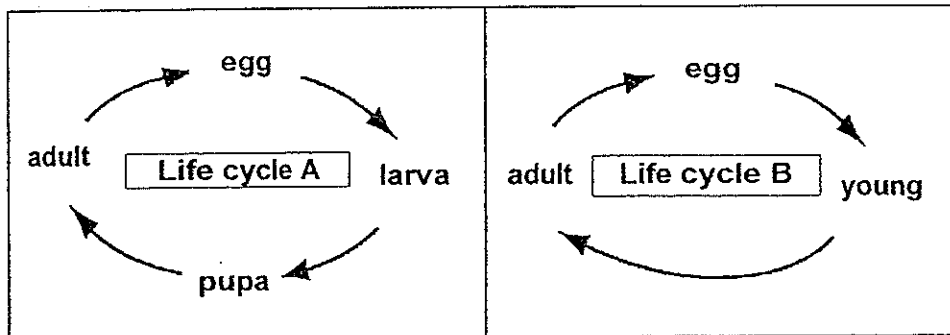

Raja grouped the following organisms according to the two different life cycles.

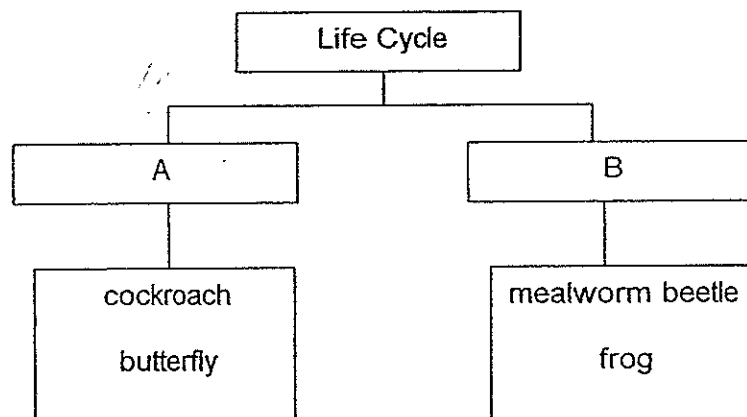

Which of the above organisms were grouped **incorrectly**?

- (1) butterfly and frog
- (2) cockroach and frog
- (3) butterfly and mealworm beetle
- (4) cockroach and mealworm beetle

7. The table below shows that certain temperatures can affect organism X in the following ways:
- number of eggs laid by the female X each time
  - length of its life cycle (from the time the eggs are laid to the end of its adult stage)

Temperature of the surroundings (°C)	Number of fertilised eggs laid	Length of life cycle of X (days)
18	50	25
22	112	15
26	136	13
30	215	10

At a certain time of the year, the life cycle of X in a farm is shown below.

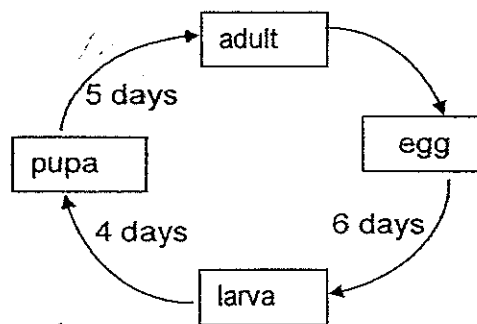

Based on the information above, which of the statement(s) is/are incorrect?

- A The surrounding temperature in which X lived was 22°C.
- B It took 10 days for X to change from its larval to pupal stage.
- C X reproduced more quickly when it lived in warmer surroundings of 22°C to 30°C.

- (1) A only
- (2) B only
- (3) A and C only
- (4) A, B and C

8. The diagram below shows the life cycle of a flowering plant. X and Z represent the developmental stages of its life cycle.

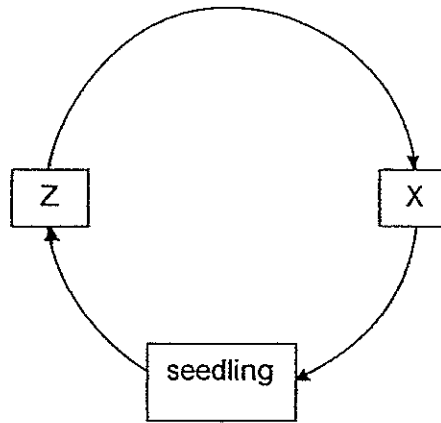

Life cycle of a flowering plant

Which one of the following identifies the correct stages of development?

	X	Z
(1)	Adult	Seed
(2)	Adult	Seedling
(3)	Seed	Adult
(4)	Seedling	Seed

9. The diagram below shows the labelled parts, Q and R, of a human reproductive system.

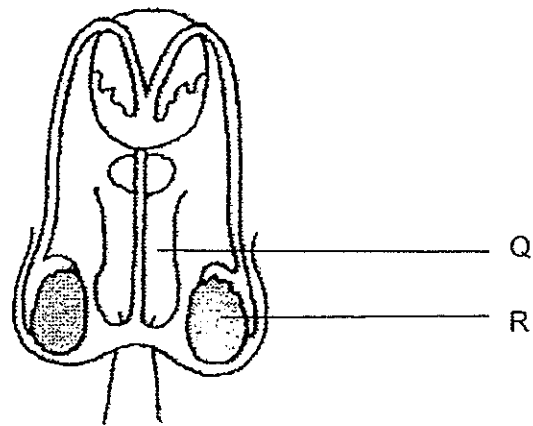

Which of the following statement(s) is/are correct?

- A Q produces reproductive cells.
- B R produces reproductive cells.
- C Q delivers reproductive cells into the female reproductive system.
- D R produces and delivers reproductive cells into the female reproductive system.

- |                  |                  |
|------------------|------------------|
| (1) C only       | (2) A and B only |
| (3) A and D only | (4) B and C only |

10. The diagram below shows some sperms and an egg.

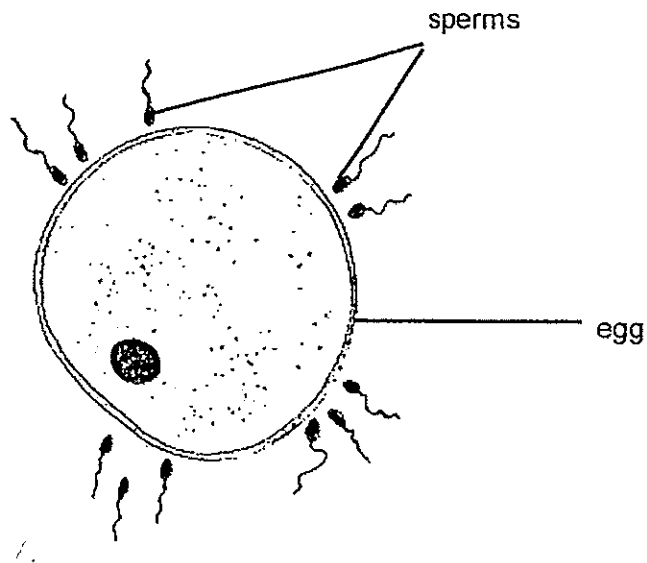

Which of the following statement(s) is/are correct?

- A Only one sperm can fertilise the egg.
- B The fertilized egg will develop into a fruit.
- C Cell division will occur once the egg has been fertilized.
- D The sperm and egg are produced in the male reproductive system.

- (1) A and C only
- (2) A and D only
- (3) B and C only
- (4) B and D only



11. Study Anna's family tree below. The family tree shows Anna's family members who either have attached or detached earlobes.

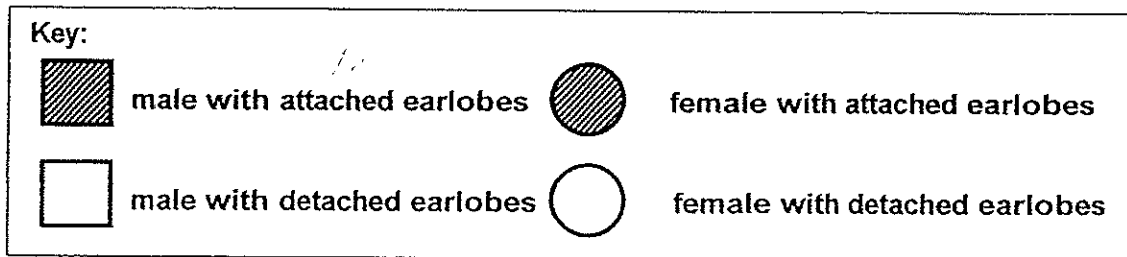
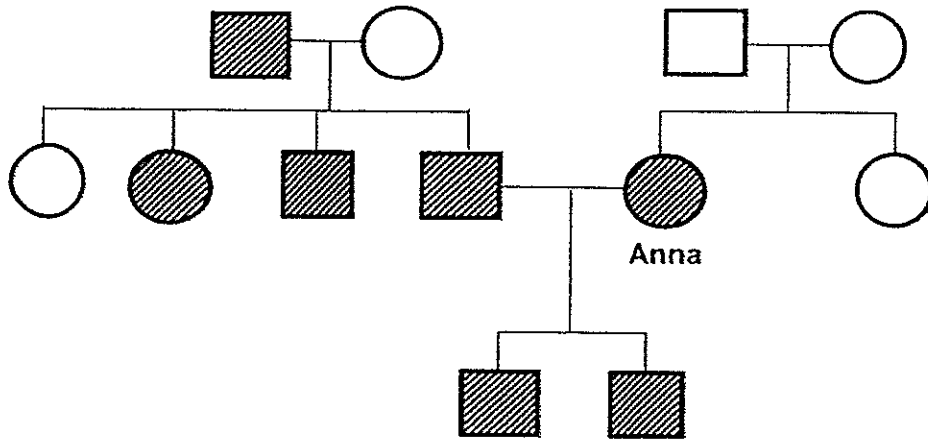

Based on the information above, which of the following statements are correct?

- A Anna's brother has attached earlobes.
- B Anna's husband has attached earlobes.
- C Two of Anna's sisters-in-law have detached earlobes.
- D Anna's sons inherited the attached earlobe from her and her husband.

- |                  |                  |
|------------------|------------------|
| (1) A and B only | (2) A and C only |
| (3) B and D only | (4) C and D only |

12. The diagram below shows a blockage at both parts, X and Y, of a reproductive system in an adult.

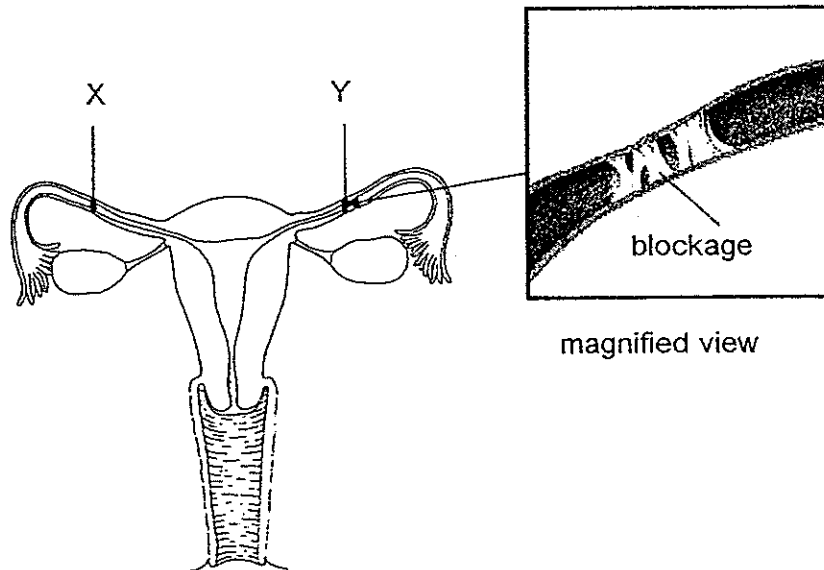

Based on the above information, which one of the following statements correctly states how the blockages at X and Y will affect the reproductive system shown above?

- (1) The reproductive system will produce damaged egg cells.
- (2) The reproductive system will not be able to produce any egg cells.
- (3) The male reproductive cell entering the above reproductive system will not be able to reach the egg cell.
- (4) The woman with the above reproductive system can get pregnant naturally but will give birth to deformed baby.

13. The diagrams below show the cross-sections of Flowers 1 and 2 from plants of the same species.

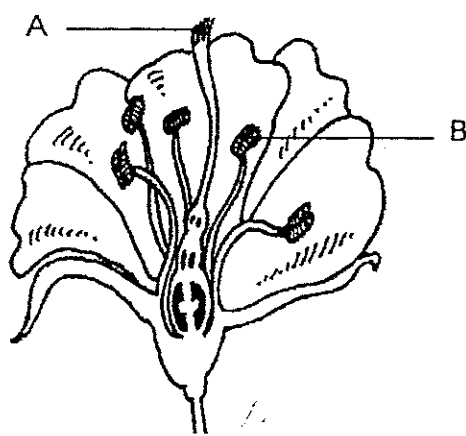

Flower 1

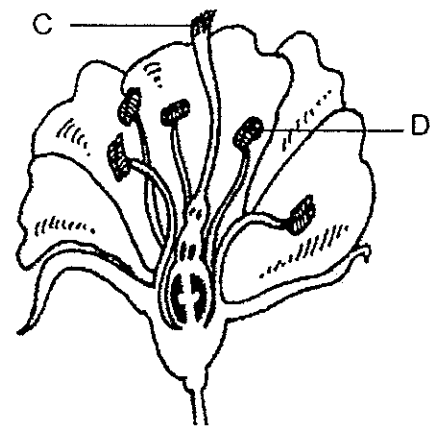

Flower 2

Which one of the following correctly shows the way in which pollen grains are transferred during pollination?

- |            |            |
|------------|------------|
| (1) A to C | (2) B to C |
| (3) A to D | (4) B to D |

14. Ali counted the number of three different types of young plants, P, Q and R, at various distances from their parent plants in a nature reserve.

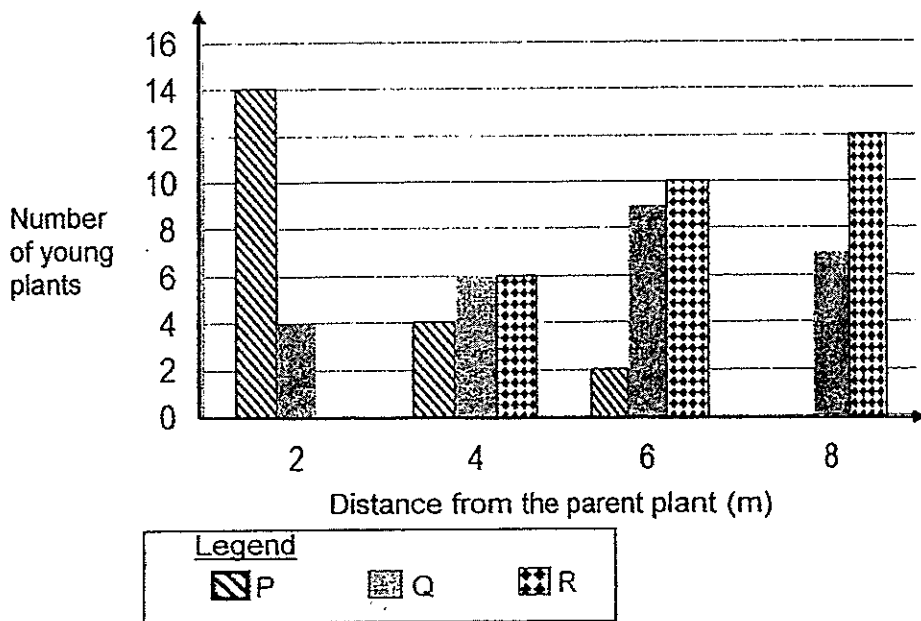

The following diagrams, P, Q and R, show the positions of the parent plants and their respective seedlings over an area.

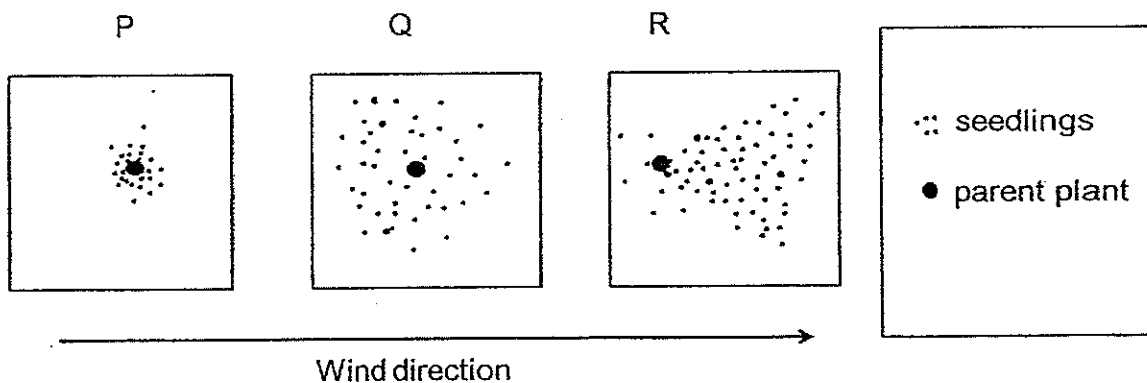

Based on the information above, which one of the following shows the most likely method of seed dispersal for plants P, Q and R?

	P	Q	R
(1)	wind	animal	splitting
(2)	wind	splitting	animal
(3)	splitting	wind	animal
(4)	splitting	animal	wind

15. The diagrams below show two seeds, X and Y.

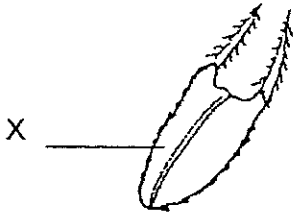
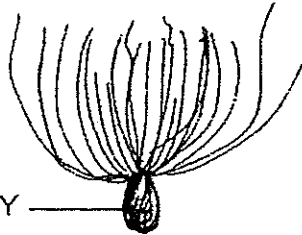
<b>Characteristics of the seed</b>	
	<ul style="list-style-type: none"> <li>- X is small and light.</li> <li>- There are short and stiff hairs on a pair of tooth-like structures at one end of the seed.</li> </ul>
	<ul style="list-style-type: none"> <li>- Y is small and light.</li> <li>- There are long and soft hairs on one end of the seed.</li> </ul>

Based on the characteristics of each seed, which of the following most likely describe(s) the method of dispersal for seed X and Y correctly?

- A X is dispersed by splitting.
- B Y is dispersed by wind.
- C Both X and Y cannot be dispersed by animals.

- (1) A only
- (2) B only
- (3) A and B only
- (4) B and C only

16. Set-ups A, B, and C, each consisted of a 15-litre container made of a different material. In each container, a seed of the same type was placed on a piece of wet sponge. The same amount of air was pumped into the containers. The set-ups were placed under a brightly-lit lamp.

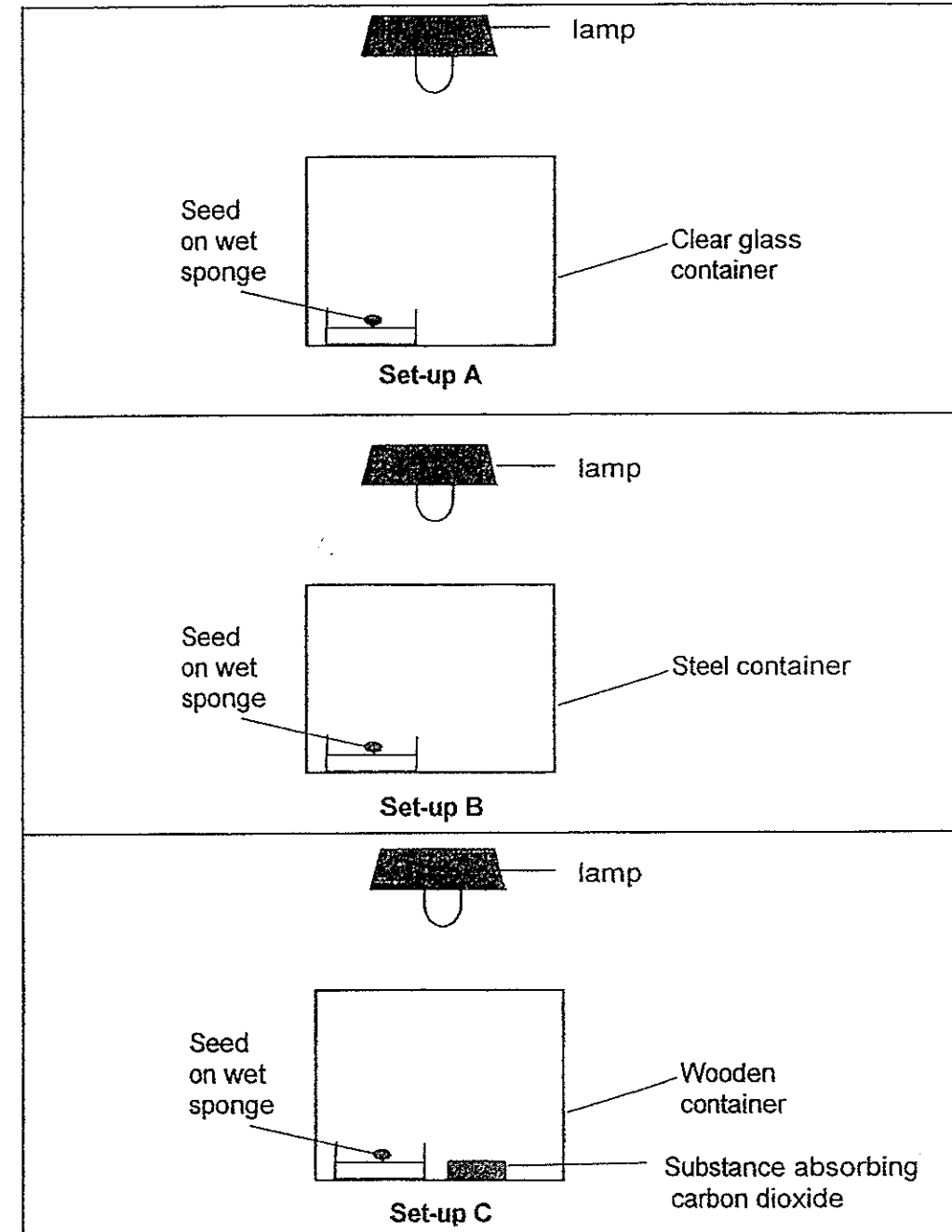

Which set-up(s) had suitable conditions for the seed to germinate?

- (1) A only  
 (2) A and B only  
 (3) B and C only  
 (4) A, B and C

17. The diagram below shows a plant cell.

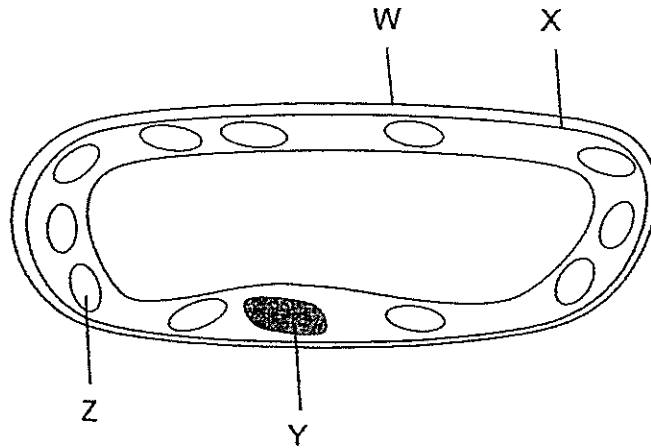

Which of these parts are not found in an animal cell?

- (1) W and Y only
- (2) W and Z only
- (3) X and Y only
- (4) X and Z only

18. The diagrams below show 3 different types of plant cells.

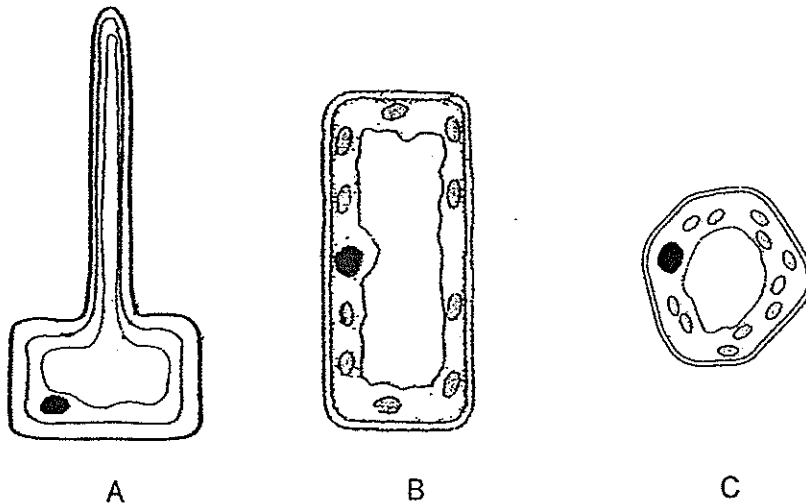

Which of these cells has/ have the ability to make food?

- (1) A only
- (2) A and B only
- (3) B and C only
- (4) A, B and C

19. Amanda placed some objects in a basin of water and made some observations. Then she drew the following flow chart to differentiate them.

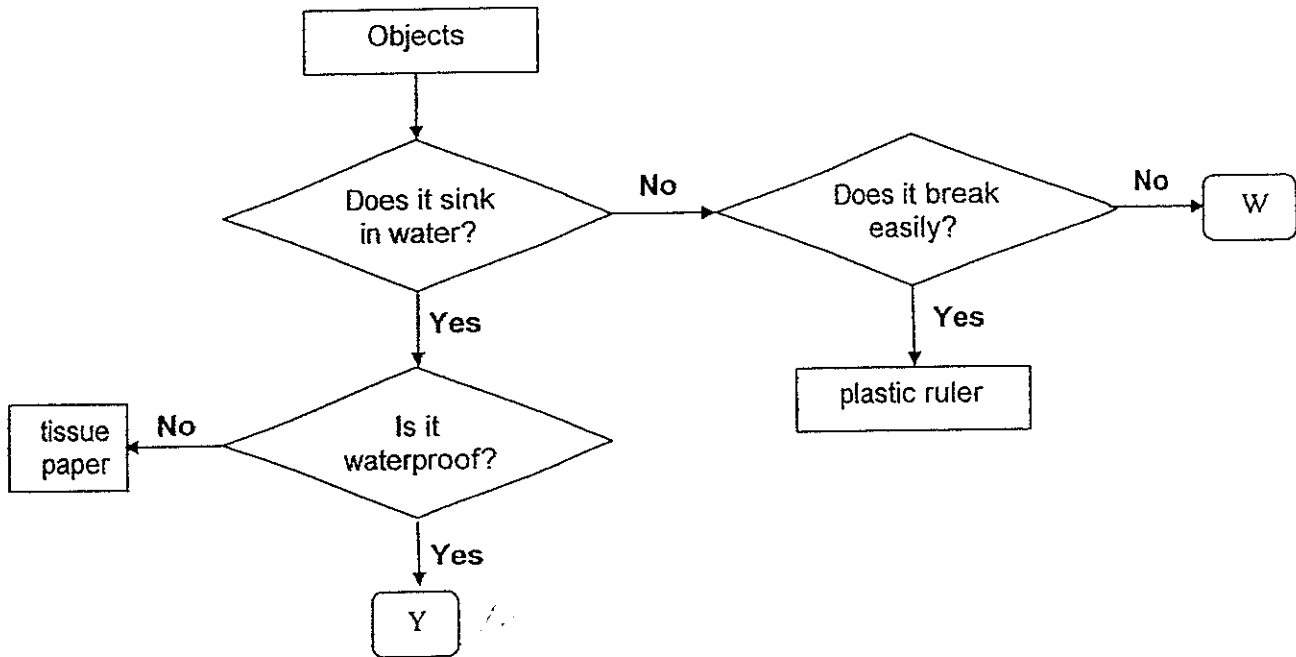

Which one of the following best represents objects W and Y?

	W	Y
(1)	straw	stone
(2)	stone	straw
(3)	marble	glass rod
(4)	glass rod	marble



20. Ravi set up an experiment using the apparatus as shown below.

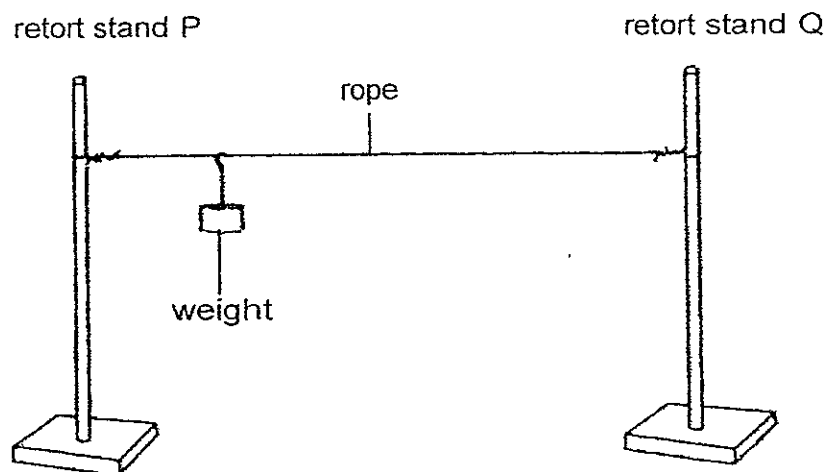

Ravi continued to add weights to the rope until it broke.

What was Ravi's purpose of conducting his experiment?

He aimed to find out the \_\_\_\_\_ of the rope.

- (1) texture
- (2) strength
- (3) elasticity
- (4) hardness

21. Ahmad measured and recorded the change in temperature of the ice cubes overtime.

Which one of the following graphs best represents Ahmad's observations?

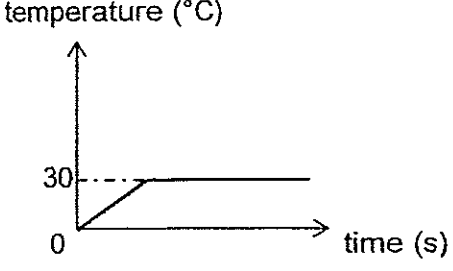
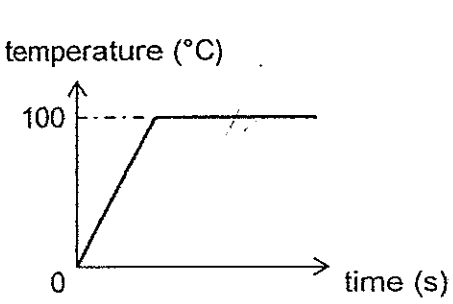
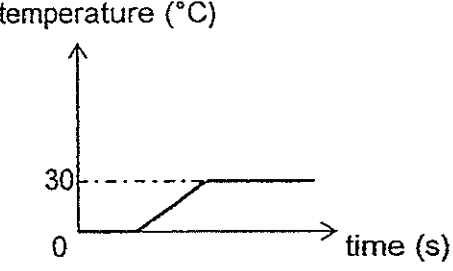
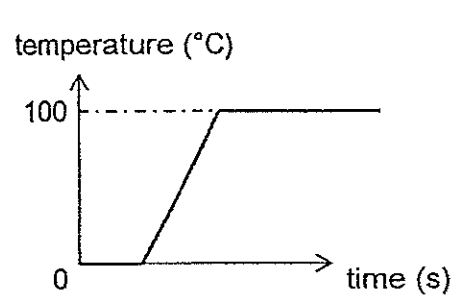
(1)	<p>temperature (<math>^{\circ}\text{C}</math>)</p>  <p>time (s)</p>
(2)	<p>temperature (<math>^{\circ}\text{C}</math>)</p>  <p>time (s)</p>
(3)	<p>temperature (<math>^{\circ}\text{C}</math>)</p>  <p>time (s)</p>
(4)	<p>temperature (<math>^{\circ}\text{C}</math>)</p>  <p>time (s)</p>

22. The conical flask with a capacity of  $200\text{ cm}^3$  contained  $50\text{ cm}^3$  of water.

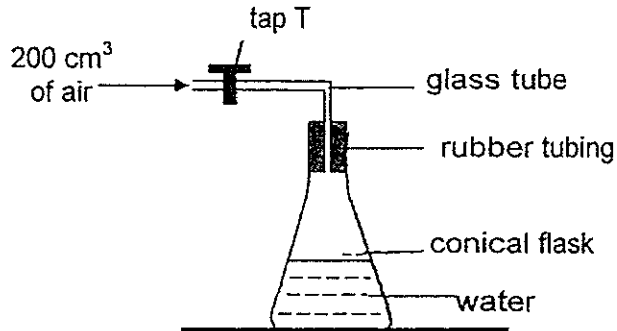

$200\text{ cm}^3$  of air was pumped into the conical flask through tap T before it was closed.

What was the final volume of air in the conical flask?

- (1)  $50\text{ cm}^3$  (2)  $150\text{ cm}^3$   
 (3)  $250\text{ cm}^3$  (4)  $400\text{ cm}^3$
23. The diagram below shows the changes that take place before the formation of rain.

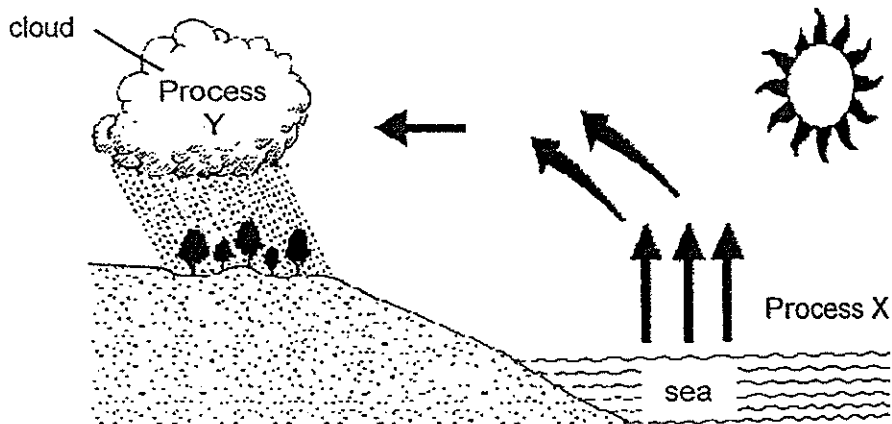

Which one of the following identifies the processes X and Y correctly?

	Process X	Process Y
(1)	evaporation	evaporation
(2)	evaporation	condensation
(3)	condensation	evaporation
(4)	condensation	condensation

24. Cheryl switched off the stove after the bun had been steamed for half an hour.

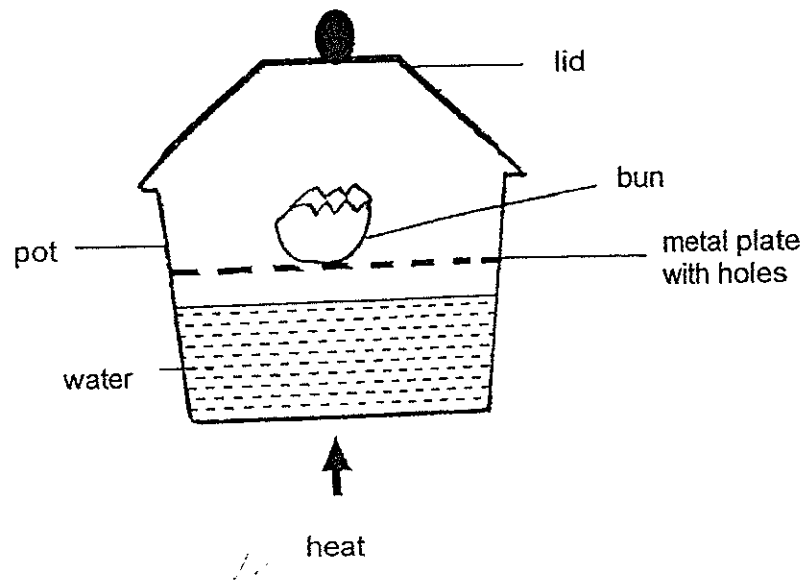

After some time, Cheryl removed the lid.

Which one of the following observations would Cheryl most likely make?

- (1) Water droplets were seen on the outer surfaces of the lid.
- (2) Water droplets were seen on the outer surfaces of the pot.
- (3) Water droplets were formed on the inner surfaces of the lid only.
- (4) Water droplets were formed on the inner surface of the lid and on the inner surface of the pot above the water level.

25. Reene hung some wet clothes outside her house. Her mother insisted that Reene spread the clothes out on the bamboo pole as shown in the diagram below.

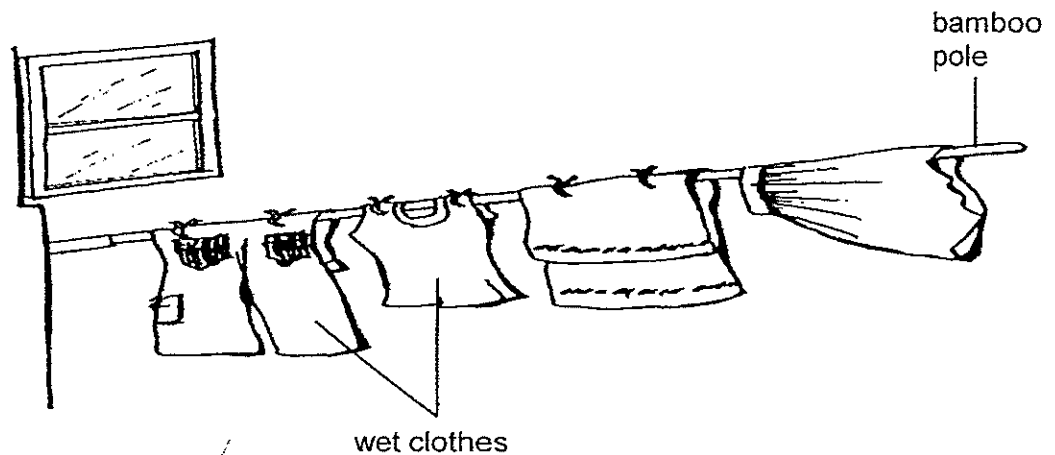

How did spreading the wet clothes help them to dry faster?

- (1) Greater exposed surface area of the clothes allowed more movement of the clothes.
- (2) Greater exposed surface area of the clothes allowed more water on them to evaporate.
- (3) Greater exposed surface area of the clothes allowed less heat from the sun to reach them.
- (4) Greater exposed surface area of the clothes allowed less wind to come in contact with them.

26. Alex used two identical empty glass jars, A and B, for an experiment. He covered the mouth of jar A with a plastic wrap. Next, he filled jar B with some ice cubes before he covered its mouth with a plastic wrap.

Then he placed both jars in a room at a constant temperature of 30°C. He weighed both jars on identical weighing scales as shown below.

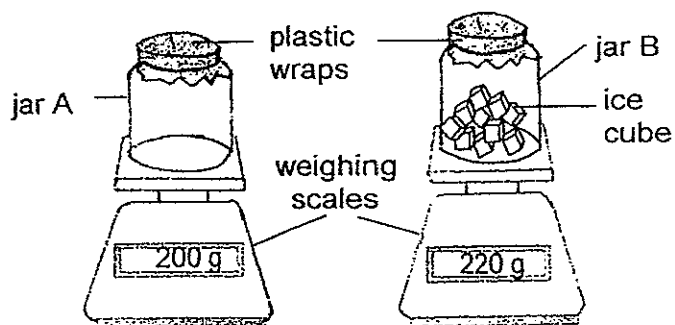

After 2 minutes, Alex observed that jar B became heavier, while the mass of jar A remained the same.

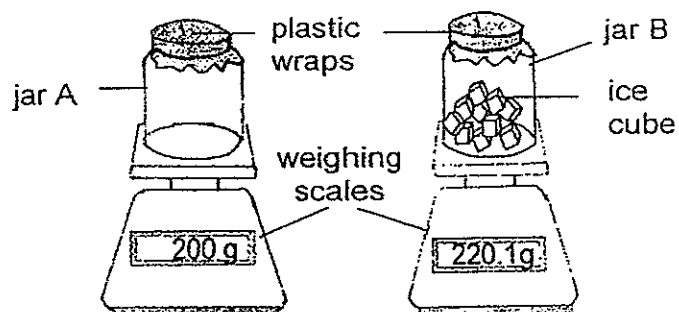

Which one of the following explains why the mass of jar B increased?

- (1) The ice cubes in jar B melted to form water.
- (2) Water vapour from the melted ice cubes condensed on the cooler inner surface of jar B.
- (3) Water vapour from the surroundings condensed on the cooler outer surface of jar B.
- (4) The melted ice cubes formed water which evaporated and condensed on the underside of the plastic wrap.

27. Mary used a light sensor connected to a data logger to measure the amount of light which passed through sheets P, Q, R, S and T, each made of a different material. The sheets were of similar size and thickness.

She plotted the graph below to show her results.

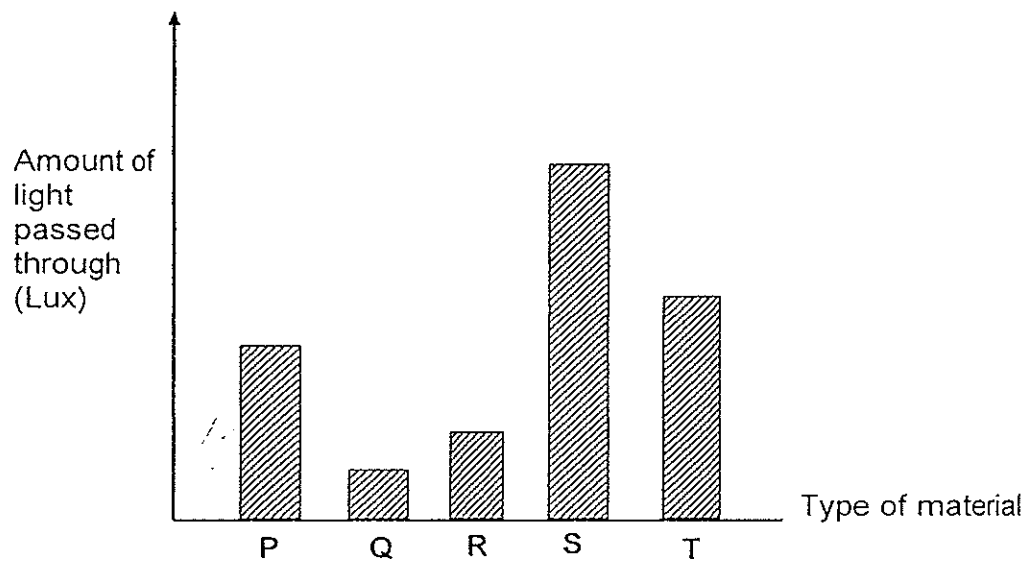

Which of these sheet(s) of material cast a darker shadow than T?

- (1) S only
- (2) P and S only
- (3) Q and R only
- (4) P, Q and R only

28. Betty hung a wind chime from a ceiling. A shadow of the wind chime was cast on the ceiling when Betty shone a light source at it.

She placed a torch at position P. She saw the shadow of the wind chime on the ceiling as shown in the diagram below. After that, she moved the torch to position Q and observed the shadow formed.

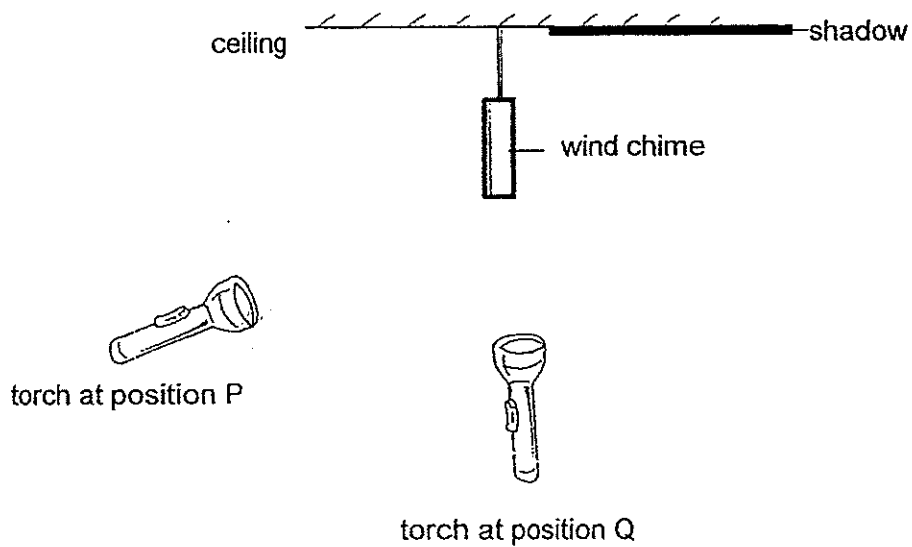

Which one of the following correctly describes the shadow of the wind chime as Betty moved the torch from position P to Q?

The length of the shadow of the wind chime \_\_\_\_\_.

- |                       |                                  |
|-----------------------|----------------------------------|
| (1) increased         | (2) decreased                    |
| (3) remained the same | (4) decreased and then increased |



29. Kenneth wrapped two identical cans, A and B, with coloured paper W and X respectively. The coloured papers were of the same thickness. He put a thermometer in each can to measure the temperature of water in it.

Kenneth left the cans under the sun from 12 pm to 12.20 pm on the same day as shown in the diagram below.

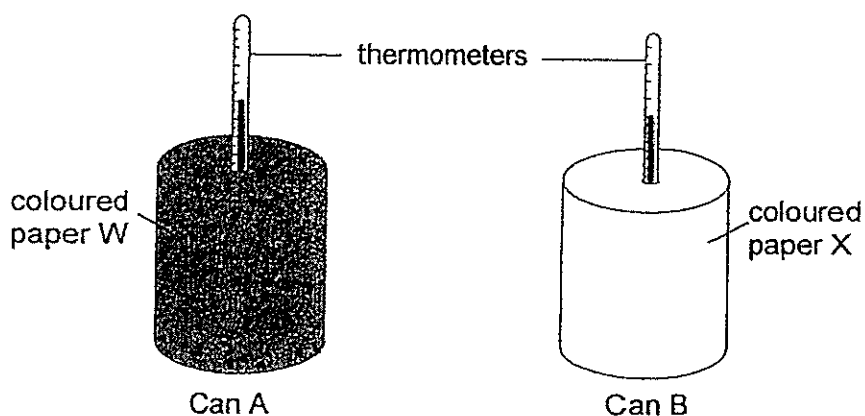

Kenneth measured and recorded the change in temperature of the water in the cans at 5-minute intervals in the table shown below.

Time (min)	Temperature of water in the can (°C)	
	Can A	Can B
0	29.0	29.0
5	31.0	29.0
10	32.5	29.2
15	33.0	29.3
20	34.0	29.5

Based on the above set-ups, which of the following factors could possibly cause the temperature of the water to be different in the cans at the end of Kenneth's experiment?

- A material of the cans
  - B amount of water in the cans
  - C coloured paper which wrapped the cans
  - D amount of time the cans were placed under the sun
- (1) A and B only                      (2) B and C only  
 (3) A, C and D only                (4) B, C and D only

30. Wee Khim observed that the ends of a metal bridge had gaps as shown in the diagram below.

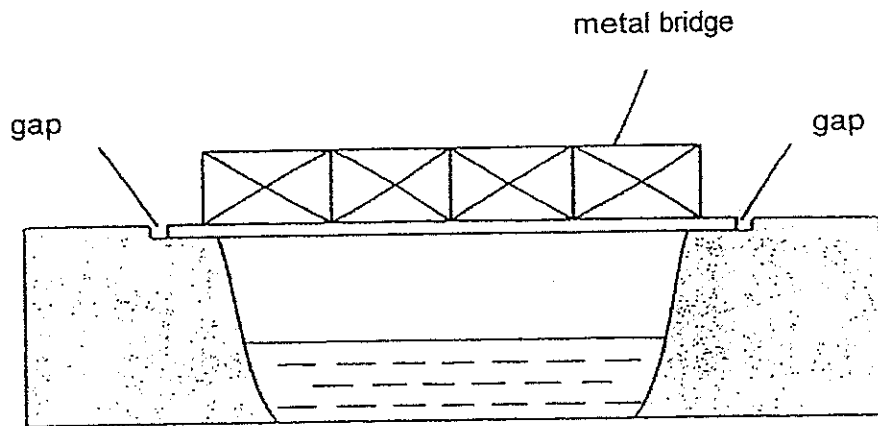

Which one of the following gives the correct explanation for the presence of these gaps?

- (1) The gaps lose heat to the surrounding on cool days and need more space to contract.
- (2) The gaps gain heat from the surrounding on hot days and need more space to expand.
- (3) The metal bridge loses heat to the surrounding on cool days and needs more space to contract.
- (4) The metal bridge gains heat from the surrounding on hot days and needs more space to expand.

Name: \_\_\_\_\_ Index No: \_\_\_\_\_ Class: P5 \_\_\_\_\_

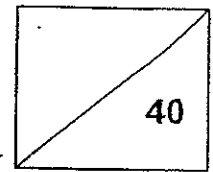

**SECTION B (40 marks)**

For questions 31 to 44, write your answers clearly in the spaces provided.

The number of marks available is shown in brackets [ ] at the end of each question or part question.

31. The flow chart below shows the characteristics of 5 different animals represented by the letters V, W, X, Y and Z.

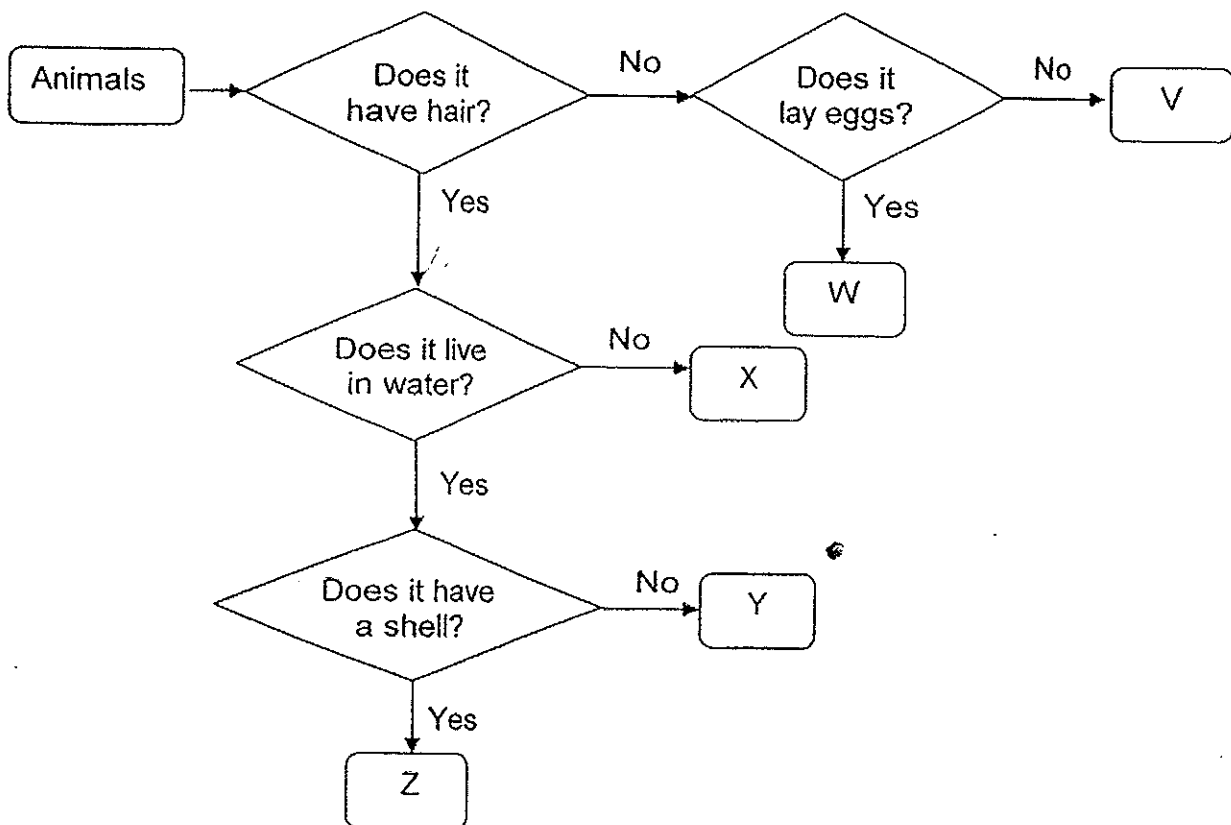

Based on the information above, answer the following questions:

(a) State one common characteristic between animals Y and Z. [1]

\_\_\_\_\_

\_\_\_\_\_

Continue on Pg 28

Score	1
-------	---

Continued from Pg 27.

- (b) State one difference between the characteristic of animals V and X. [1]

---

---

- (c) Wayne stated that animal W is a bat. Do you agree with him? Explain your answer clearly. [1]

---

---

Score	2
-------	---

32. The diagrams below show the life cycles of animals X and Y.

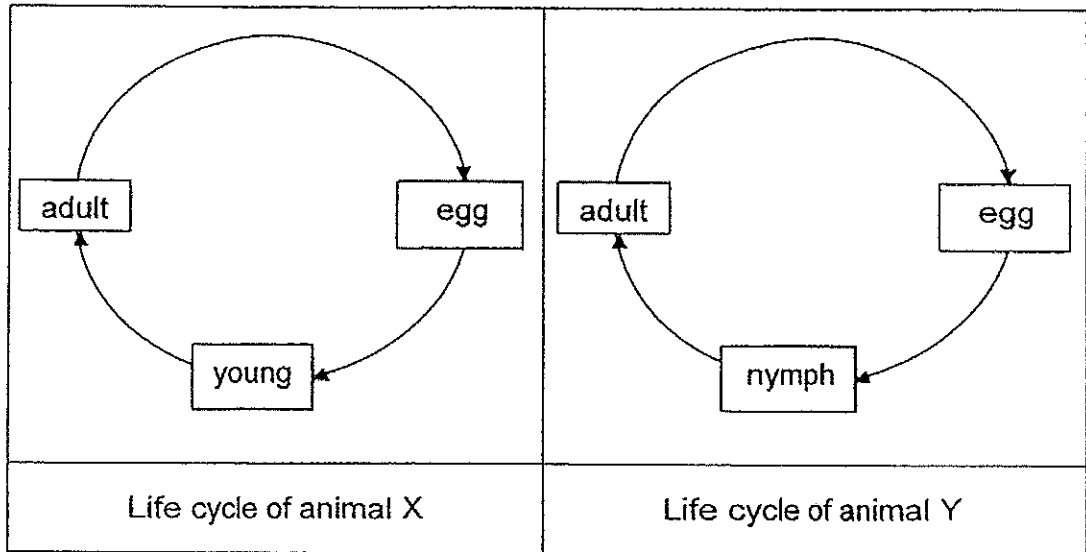

(a) Based on the diagrams above, state one similarity and difference between the two life cycles. [2]

Similarity	
Difference	

Continue on Pg 30

Score	2
-------	---

Continued from Pg 29

Lynn observed the length of time animal Y takes to remain in each stage of its life cycle.

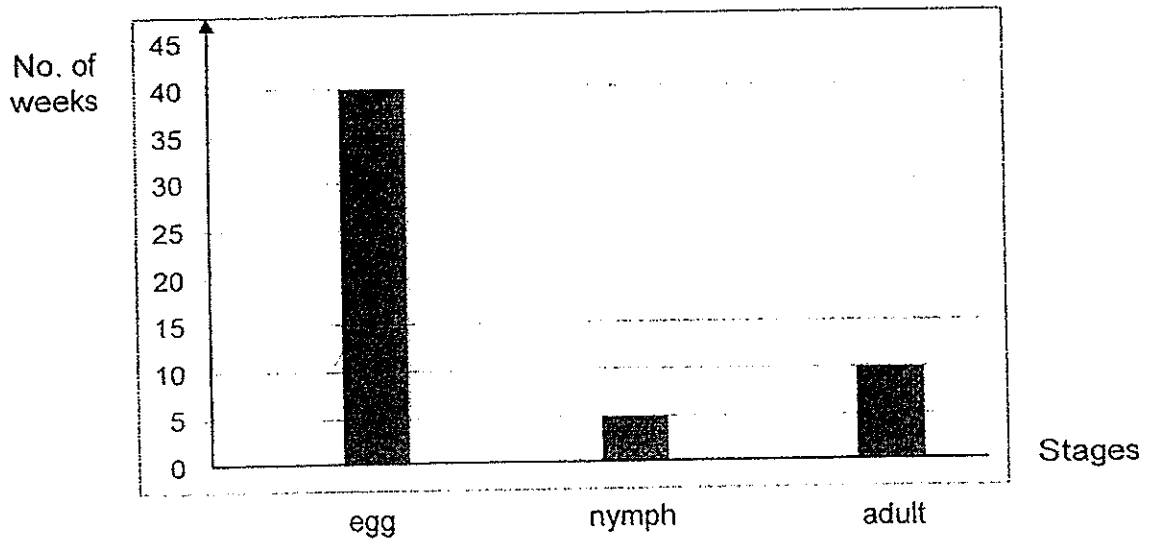

- (b) Based on Lynn's observations, how many weeks did Animal Y take to become an adult after the egg had hatched? [1]
- 

Score	1
-------	---

33. Siti wanted to conduct an experiment to find out the conditions needed for germination of seeds. She placed an equal number of seeds in containers A, B, C and D. The table below shows the conditions present in each container.

A tick in the box shows the presence of conditions in each container.

Container / Condition	A	B	C	D
Water	√	√	√	√
Air	√		√	√
Light	√	√		
Temperature (°C)	100	25	below 0	30

- (a) State one variable which Siti must keep the same in her experiment. [1]

---

- (b) In which container(s), A, B, C and/ or D, would the seeds germinate after a few days? Explain your answer clearly. [1]

---



---

Continue on Pg 32

Score	2
-------	---

Continued from Pg 31

The table below shows the mass of the seed leaves and the height of the seedlings after germination.

No. of days	Y (units)	Z (units)
5	24	13
10	19	17
15	11	26

- (c) Which column, Y or Z, contains data that shows the change in the mass of the seed leaves of the seedlings over time? Give a reason for your answer. [1]

---

---

34. A surgery was performed on an adult female to remove one of her ovaries from her reproductive system.

Will the adult female likely to be able to get pregnant naturally with only one ovary? Explain your answer clearly. [2]

---

---

Score	3
-------	---



35. The following diagrams below show two sexual reproductive systems, A and B.

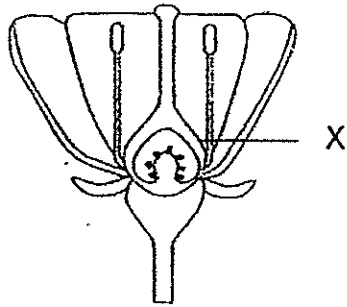

Reproductive system A

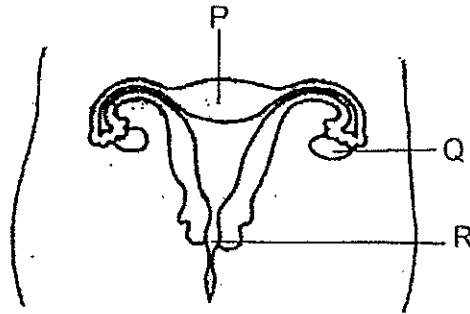

Reproductive system B

- (a) Which part, P, Q or R, has a function similar to X? Give a reason for your answer.

[1]

---



---

- (b) State one difference between the sexual reproduction in plant and human reproductive systems.

[1]

---



---

Score	2
-------	---

36. The diagram below shows the cross-section of Flower R growing on a plant.

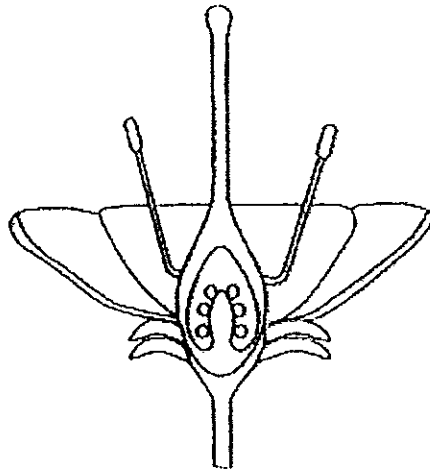

Flower R

Jane

~~Jane~~ placed pollen grains from the same type of flowers on part X of Flower R to observe if it would develop into a fruit.

- (a) In the diagram above, **label** the part, X, to show where Jane should place the pollen grains. [1]

- (b) Describe clearly what change would be observed of Flower R after the process in (a) has taken place. [2]

---

---

- (c) Name the part of the flower that Jane took the pollen grains from. [1]

---

---

37. The diagrams below show two cells, R and S.

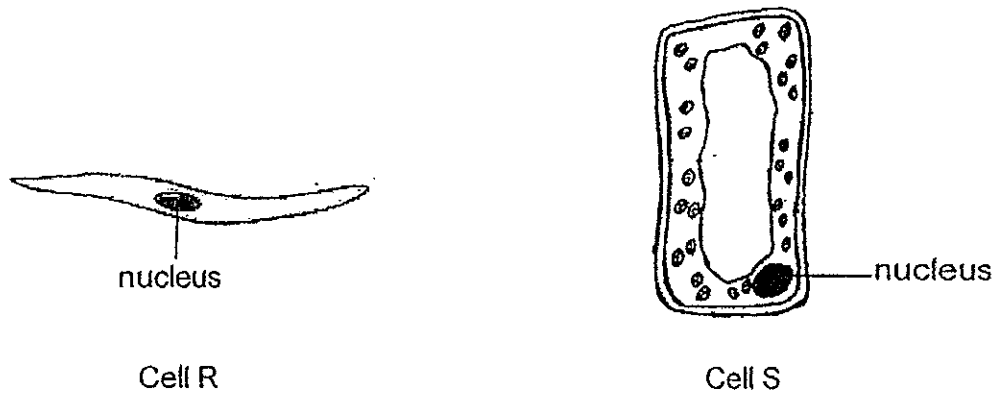

(a) Which cell, R or S, is a leaf cell? Explain your answer. [2]

*1.*

---

---

(b) Based on the structure of cell R, can it reproduce? Give a reason for your answer. [1]

---

---

Score		3
-------	--	---

38. Bob placed two identical ice blocks, W and X, on identical hot plates in the manner as shown below.

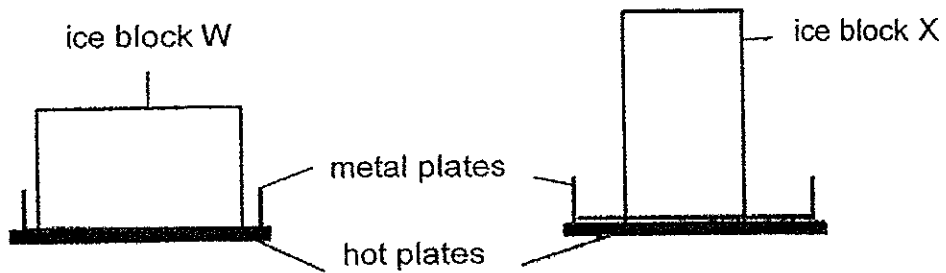

- (a) Which ice block, W or X, would melt completely first?  
Explain your answer. [2]

---

---

Bob replaced the metal plates with another set of plates of the same size and thickness. Each plate was made of a different material, Y and Z.

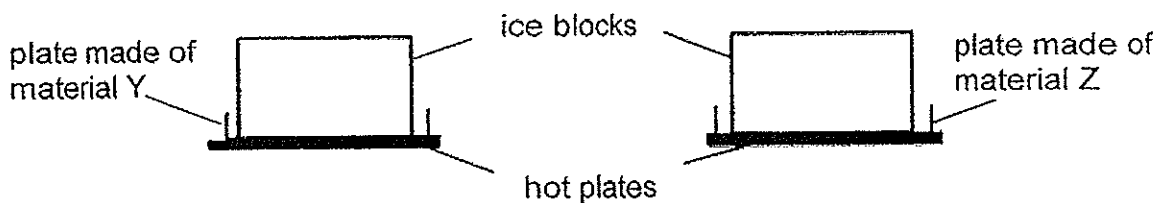

Bob observed that with the same amount of heat from the hot plates, the ice block on the plate made of material Z melted more quickly.

- (b) Give a reason to Bob's observations. [1]

---

---

Score	3
-------	---

39. May wanted to find the volume of a marble. She used a kitchen scale to do so.

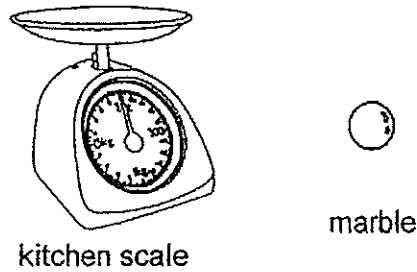

- (a) Josh told May that she had used the wrong apparatus. What could the kitchen scale be used to find out about the marbles? [1]

Josh told May to use the apparatus below.

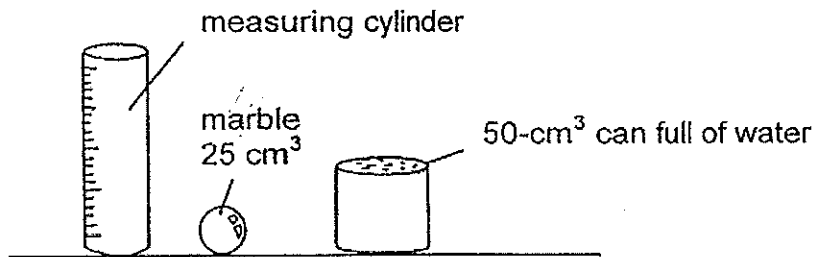

May filled the can full of water and the marble into the measuring cylinder. She drew her observations as shown in the diagram below.

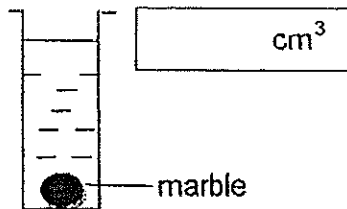

- (b) In the box shown in the diagram above, state the reading for the new water level observed. [1]
- (c) What could May conclude about the marble in this experiment? [1]

Score	3
-------	---

40. Xinyi filled 4 different containers, A, B, C, and D, each with 120 ml of water and left them in an open field as shown below.

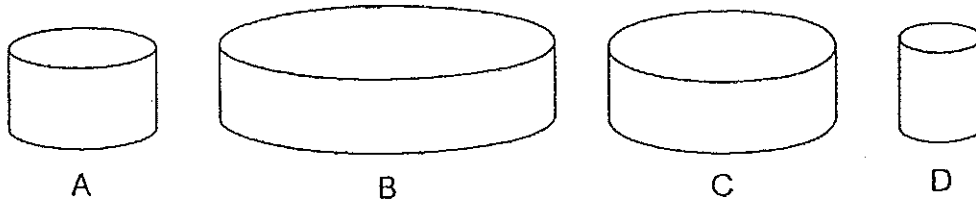

After 3 hours, she observed the amount of water in each container and recorded her results as shown in the graph below.

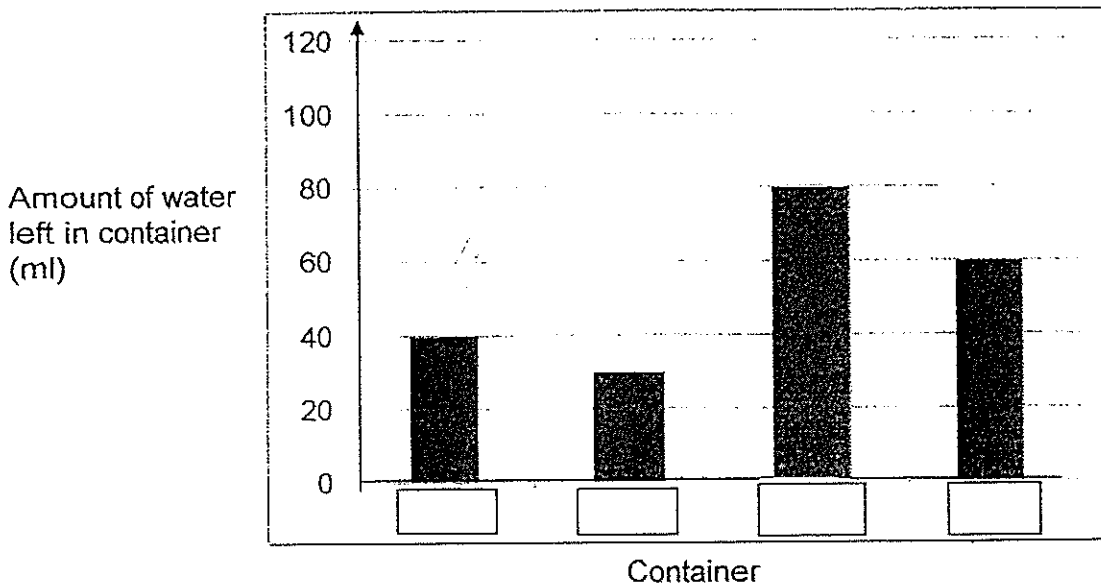

- (a) In the graph above, identify the correct amount of water left in each container by writing A, B, C and D correctly in each box shown above. [2]
- (b) If Xinyi were to put container A in the refrigerator instead of the open field, would the amount of water left after 5 hours be the same? Give a reason for your answer. [1]

---



---

Score	3
-------	---

41. Jan poured the same amount of water into the two identical glasses, A and B, as shown below.

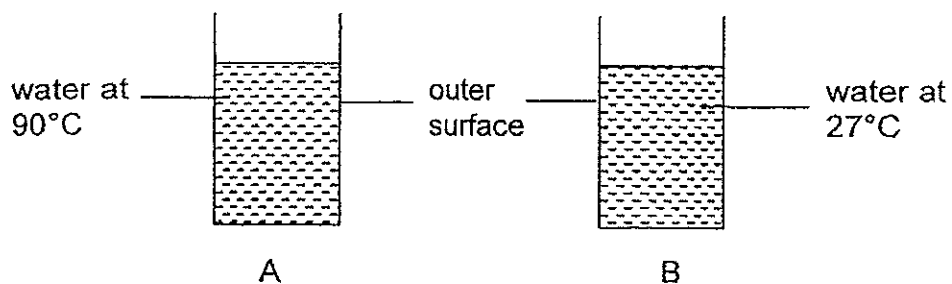

Next, she kept the filled glasses in the freezer for 5 minutes.

Jan removed glasses A and B from the freezer and placed them on her kitchen table. She saw droplets of water on the outer surface of glass B within a few seconds, however, the outer surface of glass A remained dry.

Explain why the outer surface of glass A remained dry.

[2]

---

---

---

Score	2
-------	---

42. Agnes stacked the wooden cubes and placed them between the light source and screen as shown in the diagram below.

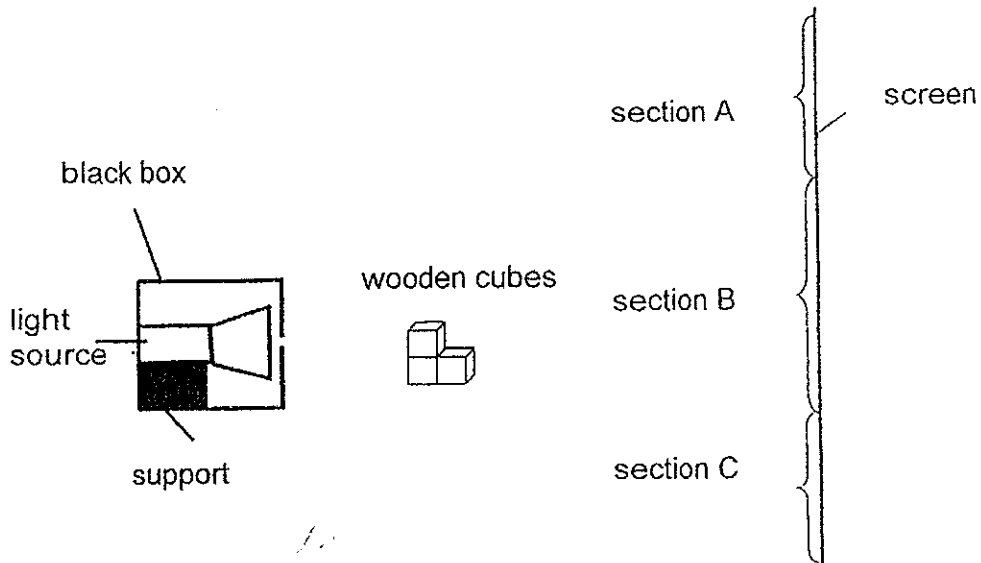

- (a) Name the parts of the screen where the shadow of the wooden cubes was seen. [1]

---

- (b) Other than light cannot pass through opaque materials, state one property of light which caused the formation of the shadow of the wooden cubes. [1]

---



---

Agnes replaced the wooden cubes with plastic cubes. She could see a lighter shadow cast on the screen.

- (c) Based on this experiment, what could Agnes conclude about the degree of transparency of the plastic cubes? [1]

---



---

Score	3
-------	---



43. Leela placed a burning candle directly below a metal wire connected to a wooden block at its other end as shown in the diagram below.

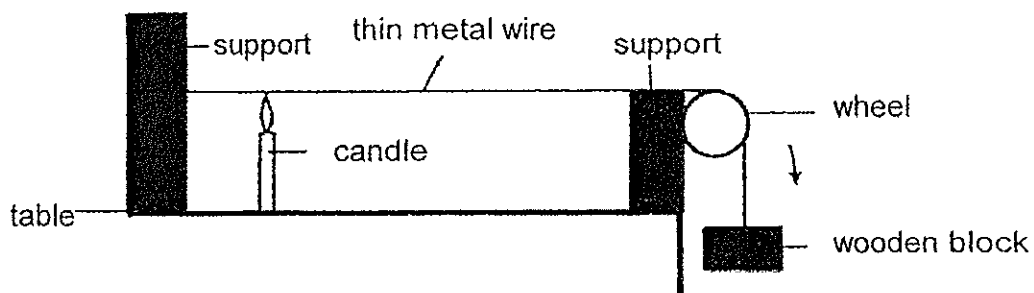

After a while, Leela observed that the wooden block moved in the direction as shown by the arrow above.

- (a) What caused the wooden block to move?  
Explain your answer.

[1]

---

---

Next, Leela removed the burning candle.

- (b) What would Leela observe about the wooden block after a while? Explain your answer.

[2]

---

---

---

Score	3
-------	---

44. Seth poured an equal amount of water of the same temperature into two identical saucepans, X and Y. He put the saucepans on hot plates with the same amount of heat. He covered saucepan Y with a lid as shown below.

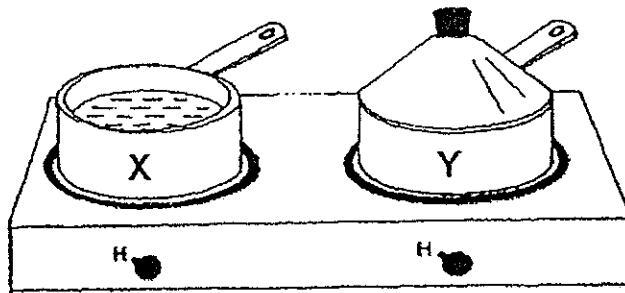

Seth recorded the time taken for the water in both saucepans to boil. He plotted a graph as shown below to show the results of his experiment.

temperature of water ( $^{\circ}\text{C}$ )

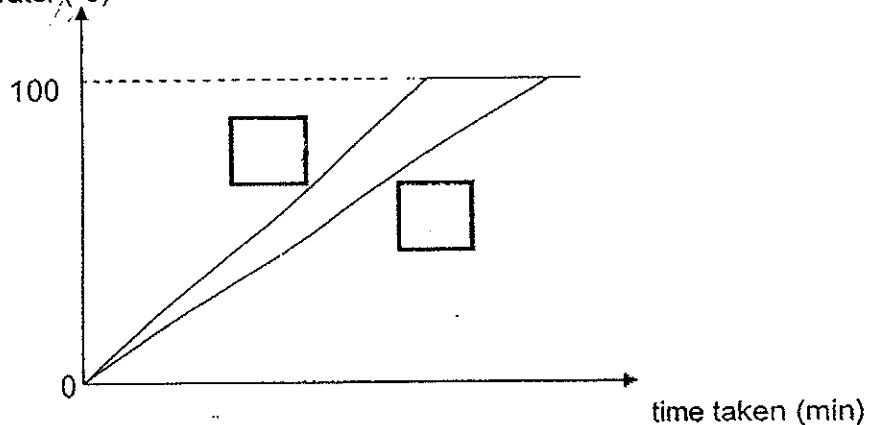

- (a) Identify the line which represents the change in the temperature of the water in the saucepan in which water boiled first.

In the graph above, label the line X or Y in the correct box to identify the saucepan in which water boiled first. [1]

Continue on Pg 43

Score	1
-------	---

In another experiment, Seth placed an egg of similar size in identical saucepans with an equal amount of water of the same temperature. Identical lids were used to cover the saucepans.

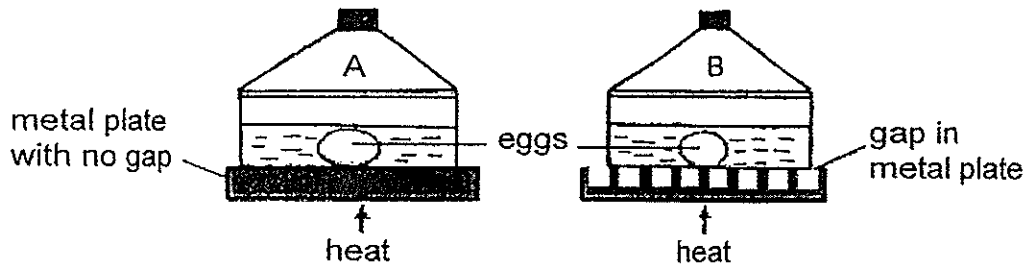

Using the same amount of heat, one egg was cooked more quickly than the other.

- (b) In which saucepan, A or B, would the egg cook first?  
Explain your answer.

[2]

---

---

---

- END OF PAPER -

Score	2
-------	---

Setters: Ms Chong Jieqi, Ms Ho Hsien Lin, Mrs Sharon Maggie Seet



## Exam Paper 2014 Answer Sheet

School: RAFFLES GIRLS' PRIMARY SCHOOL

Subject: PRIMARY 5 SCIENCE

Term: SA1

1) 3	6) 4	11) 3	16) 4	21) 3	26) 3
2) 1	7) 2	12) 3	17) 2	22) 2	27) 4
3) 3	8) 3	13) 2	18) 3	23) 2	28) 2
4) 3	9) 4	14) 4	19) 1	24) 4	29) 2
5) 3	10) 1	15) 2	20) 2	25) 2	30) 4

31. (a) Both animals live in water.  
(b) X has a body covering of hair but V does not.  
(c) No, I do not agree with him. Bat has a body covering of hair but W does not, thus W is not a bat.

32. (a) Similarity: Both life cycles have 3 stages.  
Difference: Y goes through a nymph stage but X does not.  
(b) 5 weeks.

33. (a) The amount of water for each container.  
(b) D would germinate after a few days. It has air, water and warmth which are the conditions needed for seed germination.  
(c) Y. The seed leaves provide food for the germinating seed. Therefore, the mass of the seed leaves will decrease.

34. Yes. The ovary will contain egg and fertilisation can still occur.

35. (a) Q. Both parts contain female reproductive cells.  
(b) Plant reproductive system will need to go through pollination before fertilization could take place but not in human reproductive system.

36. (a)

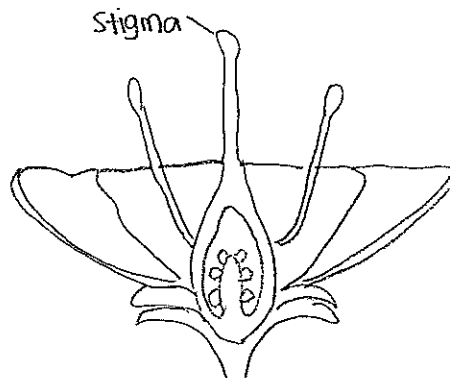

(b) The ovary will swell to develop into a fruit.  
(c) Anther.

37. (a) S. It has a cell wall and chloroplasts containing chlorophyll that traps sunlight for the leaf to photosynthesis.



- (b) Yes. R has a nucleus which controls cell division.
38. (a) W. It has a larger surface area exposed to the hot plate so the ice gained heat more quickly.  
 (b) Z can conduct heat more quickly.
39. (a) It could find out the mass of marbles.  
 (b) 75  
 (c) The marble has a definite volume.
40. (a) C, B, D, A  
 (b) No, the temperature in the fridge is lower thus the rate of evaporation of water will be slower so more water will be left. The air in the fridge is cooler so the water evaporates slower.
41. The temperature of the outer surface of glass A was higher than water vapour in the air as the hot water in glass A did not lose much heat in 5 minutes and is still hotter than water vapour, hence condensation of water vapour did not occur. The temperature of the surface of glass A was higher than water vapour in the air so it cannot act as a cooler surface for the water vapour to lose heat and condense into water droplets.
42. (a) B and C.  
 (b) Light travels in a straight line.  
 (c) It is translucent and can allow some light to pass through.
43. (a) The candle flame heated the metal wire and the wire expanded.  
 (b) It moved upwards when the metal wire lost heat and contracted.
44. (a)

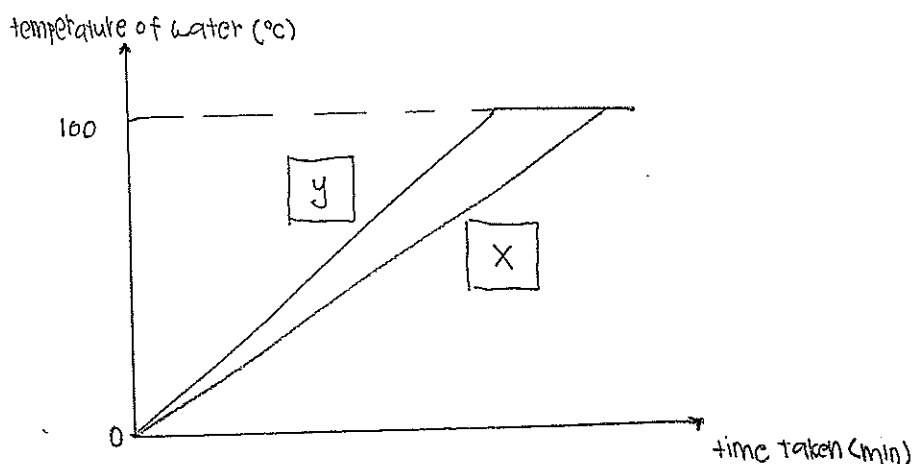

- (b) A. There was a greater surface area of contact between the metal plate and the base of saucepan A than saucepan B. Thus, saucepan A gained more heat and cooked the egg first. More surface area of the base of A was in contact with the heated metal plate than B, so heat gained fast thus cooking the egg first.

