

Name : \_\_\_\_\_ ( )

Class : Primary 5 \_\_\_\_\_

## CHIJ ST NICHOLAS GIRLS' SCHOOL



Primary 5

Second Semestral Assessment – 2007

SCIENCE

BOOKLET A

12<sup>th</sup> October 2007

Total Time for Booklets A and B: 1 hour 45 minutes

30 questions  
60 marks

Do not open this booklet until you are told to do so.  
Follow all instructions carefully.  
Answer all questions.

**Section A : (30 x 2 marks)**

For each question from 1 to 30, four options are given. One of them is the correct answer. Mark your choice (1, 2, 3 or 4). Shade the correct oval (1, 2, 3 or 4) on the Optical Answer Sheet.

1. T, U and V show the positions and phases of the Moon on 3 July, 14 July and an unspecified date respectively as seen from Country F.

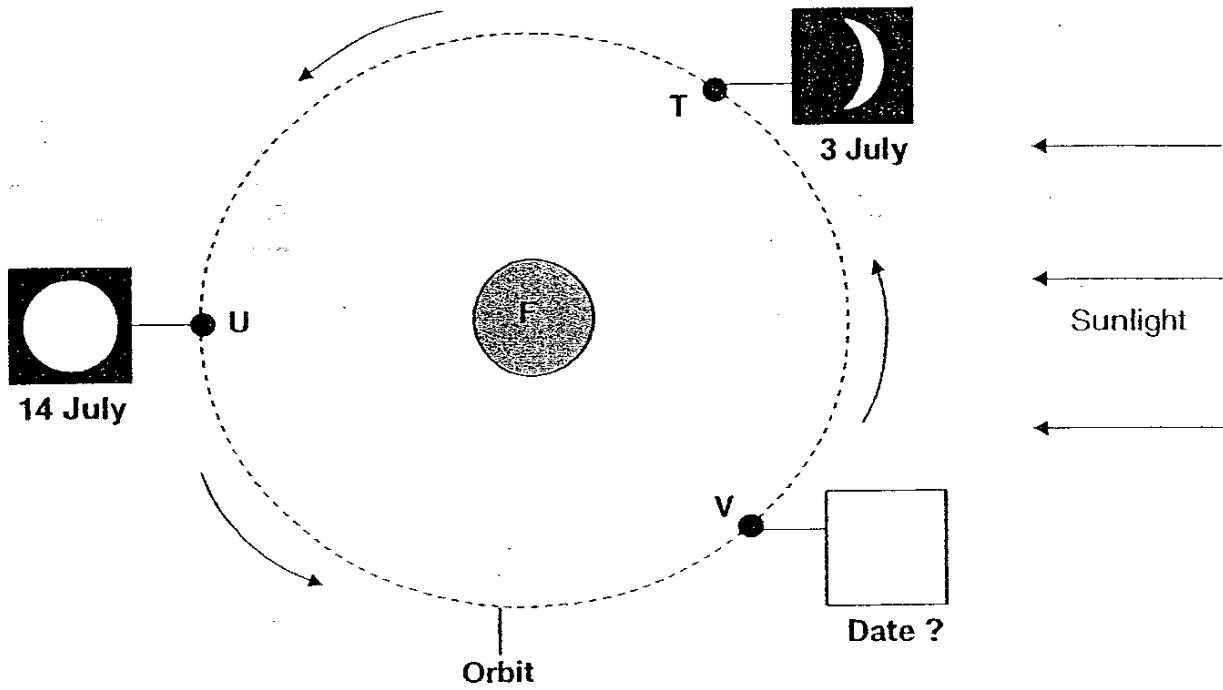

Which one of the following shows the phase of the Moon in Position V?



57

2. The diagram below shows a satellite.

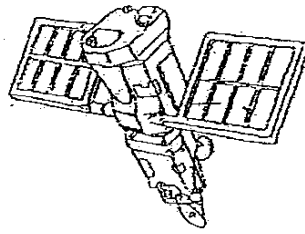

Which one of the following statement(s) about the satellite is/are correct?

- A It revolves around the sun.
- B It is a natural satellite of the Earth.
- C It helps ships and aeroplanes to locate their positions.
- D It orbits in a fixed path around another object in space.
  
- (X) C only
- (X) A and B only
- (X) C and D only
- (X) B, C and D only

3. The diagram below shows the orbits of some objects, A, B, C and D in space.

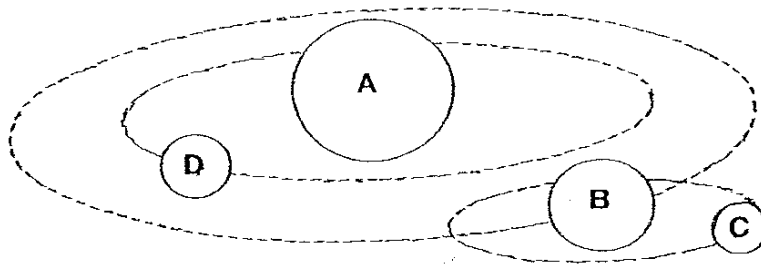

Which one of the following statements is true?

- (X) Object B revolves around Object D.
- (X) Object C is a natural satellite of Object A.
- (X) Object B, C and D are planets of Object A.
- (X) Object D takes a shorter time than Object B to revolve around Object A.

158

4. Study the table below carefully.

Planet	Distance from the Sun (million km)	Time of revolution round the Sun
A	778	12 years
B	4500	165 years
C	58	88 days
D	108	225 days
E	150	365 days

Based on the given table, what conclusions can be made about the planets?

- Planet C is the closest planet to the Sun.
- Planet B will have a lower temperature than Planet A.
- Planet E revolves around the Sun faster than Planet C.
- Among the 5 planets, the Sun will appear the smallest from Planet D.

- A and B only
- C and D only
- A, B and C only
- A, B, C and D

5. The diagrams below show 5 different cells as viewed through a microscope.

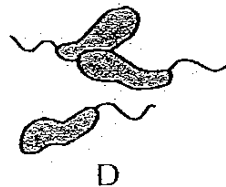
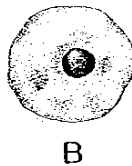
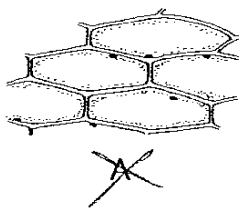

Which of the above cells are animal cells?

- A and E only
- B and D only
- A, C and E only
- B, C and D only

159

6. There are 96 paramecia after 4 generations of cell division. How many paramecia were there at first?

- ~~A~~ 3
- ~~B~~ 6
- ~~C~~ 12
- ~~D~~ 24

7. Some single-celled organisms were placed in a beaker of water and left in the open for 3 weeks. The diagram below shows the top view of the organisms at the start and end of the experiment.

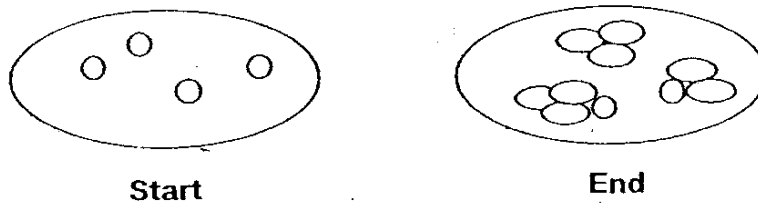

It was observed that the number and size of organisms increased after three weeks. Which could have caused the changes?

- ~~A~~ growth
- ~~B~~ reproduction and growth
- ~~C~~ reproduction and germination
- ~~D~~ growth and replacement of damaged cells

8. The diagram below shows the female reproductive system.

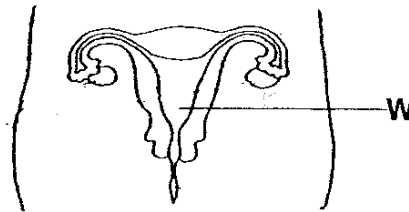

What is/are the function(s) of W?

- ~~A~~ To produce the eggs
  - ~~B~~ For cell division to take place
  - ~~C~~ To develop the unfertilised egg
  - ~~D~~ To protect and nourish the foetus
- 
- ~~A~~ A and C only
  - ~~B~~ B and D only
  - ~~C~~ A, B and C only
  - ~~D~~ B, C and D only

160

9. The diagram shows the stages of growth of a baby in its mother womb.

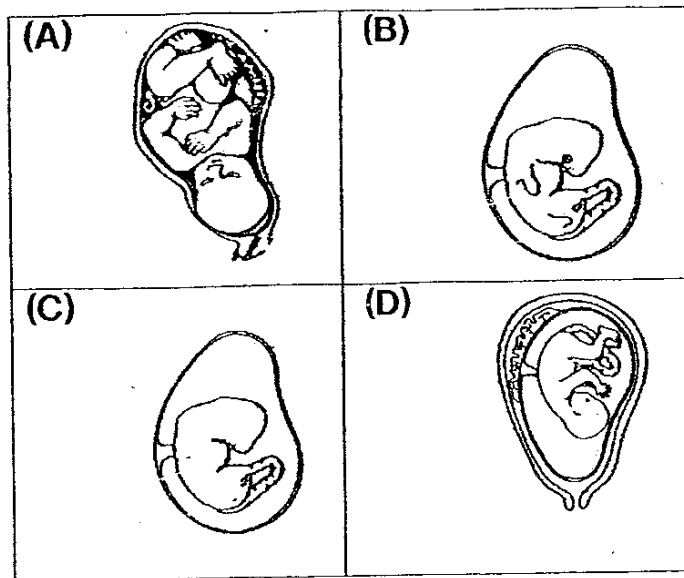

Arrange the stages of growth of the baby in the correct order.

- ~~A~~ A → D → B → C
- ~~B~~ B → C → D → A
- ~~C~~ C → B → D → A
- ~~D~~ D → B → C → A

10. The following diagram shows Lisa's family tree.

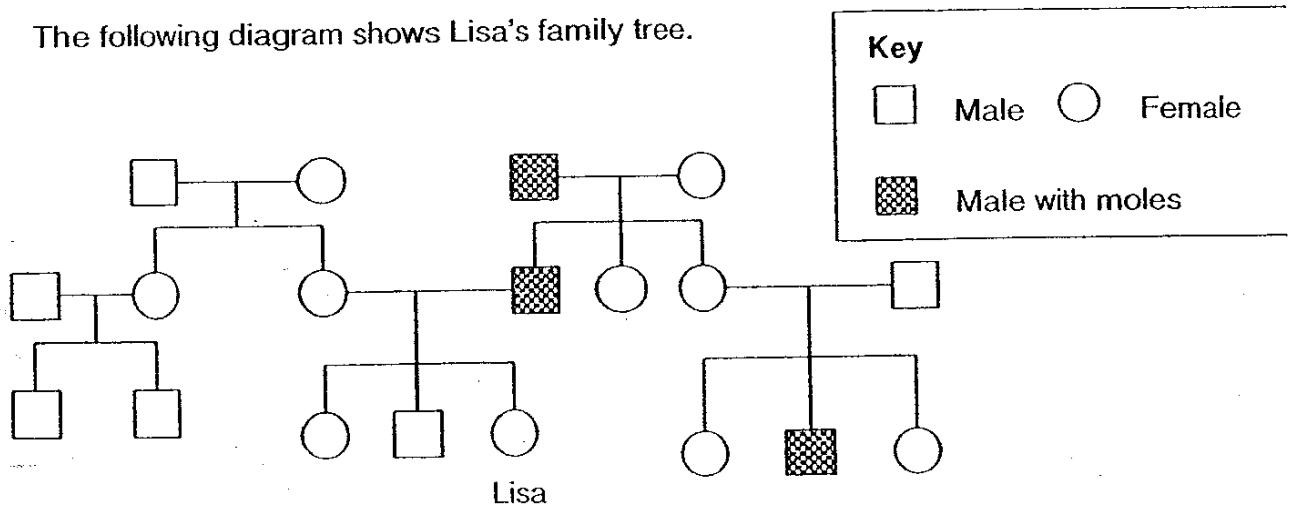

Which one of the following statements is true?

- ~~A~~ Lisa has 2 aunts and 2 uncles altogether.
- ~~B~~ There are 4 generations in Lisa's family tree.
- ~~C~~ There are 5 members altogether in Lisa's family.
- ~~D~~ One of Lisa's male cousins inherits his moles from Lisa's father.

(6)

11. Study the diagrams of the cross-sections of the 4 different flowers, N, P, Q and R given below.

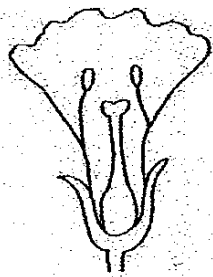

Flower N

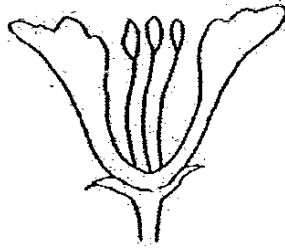

Flower P

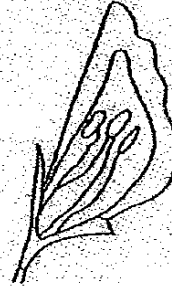

Flower Q

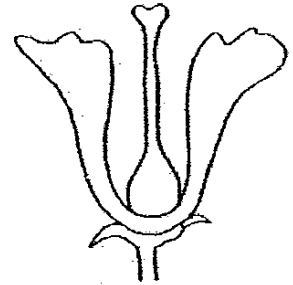

Flower R

Which of the above flowers will not develop into a fruit?

- Flower N and Flower Q only
- Flower N and Flower R only
- Flower P and Flower R only
- Flower P and Flower Q only

12. Study the classification table shown below.

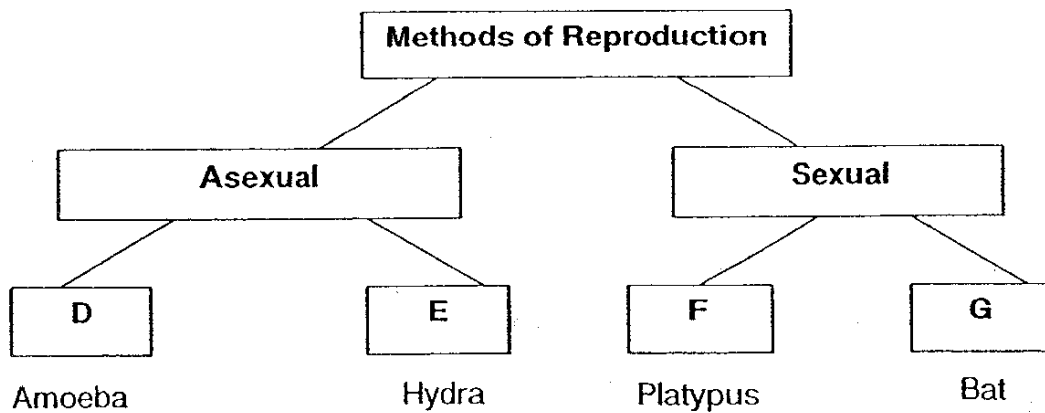

Which of the following are suitable headings for D, E, F and G?

	D	E	F	G
<input checked="" type="checkbox"/>	Budding	Binary fission	Give birth	Lay eggs
<input checked="" type="checkbox"/>	Binary fission	Budding	Lay eggs	Give birth
<input checked="" type="checkbox"/>	Budding	Binary fission	Lay eggs	Give birth
<input checked="" type="checkbox"/>	Binary fission	Budding	Give birth	Lay eggs

162

For questions 13 and 14, refer to the diagram below.

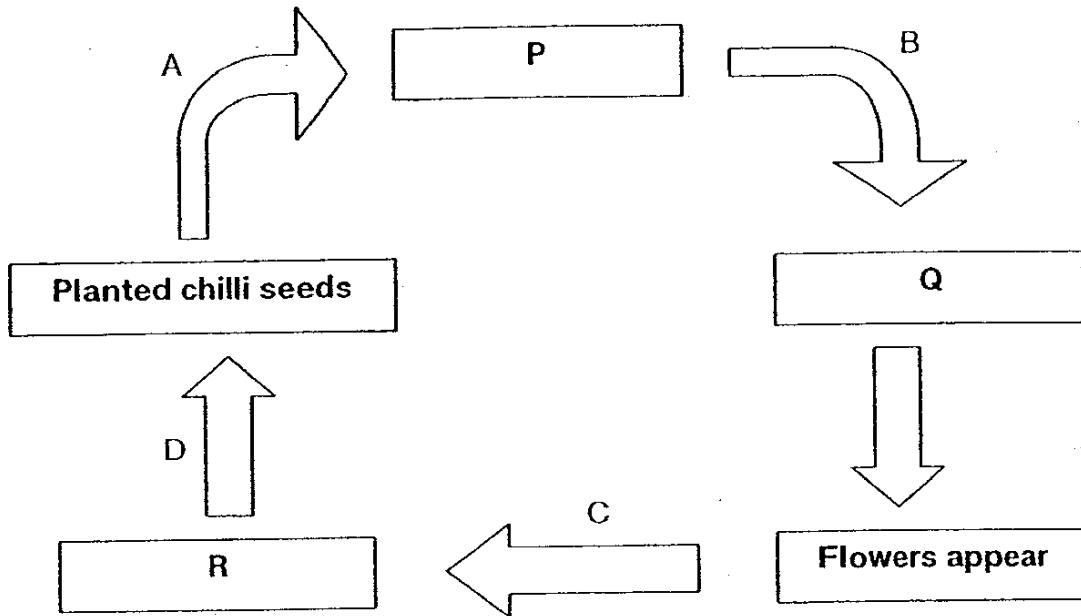

13. Study the life cycle of the chilli plant given above.

Which one of the following correctly identifies P, Q and R?

	P	Q	R
<input checked="" type="checkbox"/>	Appearance of first leaves	Fruit appear and grow bigger	Fully grown chilli plant
<input checked="" type="checkbox"/>	Seedling appears	Fully grown chilli plant	Fruits appear and grow bigger
<input checked="" type="checkbox"/>	Fully grown chilli plant	Appearance of first leaves	Fruits appear and grow bigger
<input checked="" type="checkbox"/>	Seedling appears	Appearance of first leaves	Fully grown chilli plant

14. Fertilisation and germination of the chilli plant occurs at stages \_\_\_\_\_ and \_\_\_\_\_ respectively.

	Fertilisation	Germination
<input checked="" type="checkbox"/>	B	D
<input checked="" type="checkbox"/>	C	B
<input checked="" type="checkbox"/>	C	A
<input checked="" type="checkbox"/>	D	A



15. Teck Meng wants to find out how overcrowding affects the growth of plants. Besides using the same type of soil and the same amount of fertiliser, which of the following variables should he also keep the same?

- A: Size of pots
- B: Type of plants
- C: Amount of water
- D: Number of plants
- E: A and C only
- F: B and D only
- G: A, C and D only
- H: B, C and D only

16. Study the classification table below.

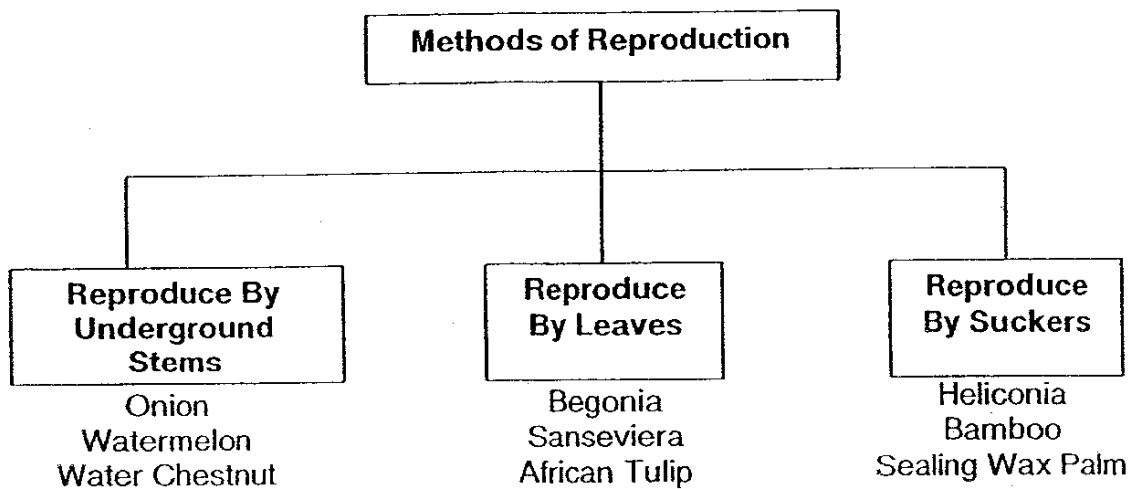

Which of the above plants have been wrongly classified?

- A: Watermelon and African Tulip
- B: Water Chestnut and Sansevieria
- C: Watermelon, African Tulip and Heliconia
- D: Sealing Wax Palm, Heliconia and Begonia

17. Study the diagrams below carefully.

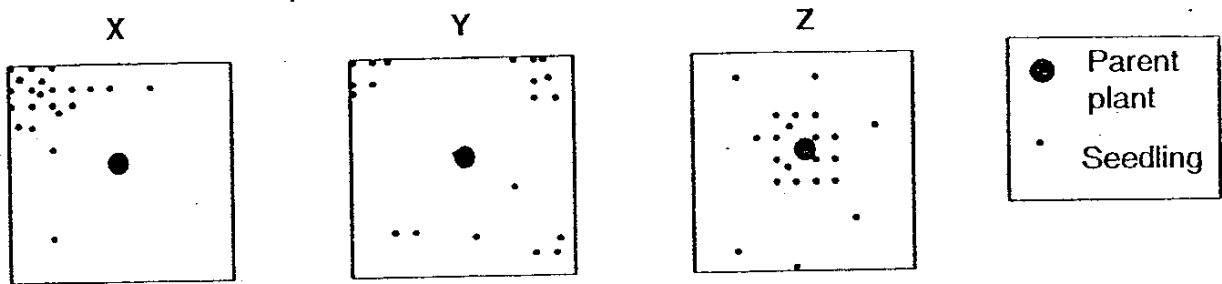

X, Y and Z show how the fruits of 3 types of plants P, Q and R are dispersed.

The characteristics of the fruits of the 3 plants are shown in the table below.

Fruit of Plant	Characteristics
P	Bristle-like hairs in the fruit
Q	Flat wing-like structures
R	Fruit wall splits open when it dries up

Which one of the following matches the fruits of the plants to their dispersal patterns?

	X	Y	Z
<del>(1)</del>	Q	R	P
<del>(2)</del>	P	Q	R
<del>(3)</del>	Q	P	R
<del>(4)</del>	R	Q	P

18. All simple machines \_\_\_\_\_.

- reduce the amount of work done.
- need an effort to overcome the load.
- change the direction of the force applied.
- enable the load to move a shorter distance than the effort.

- ~~(1)~~ B only
- ~~(2)~~ A and B only
- ~~(3)~~ B and C only
- ~~(4)~~ A, C and D only

105

19. Which one of the following graphs correctly shows the relationship between the amount of effort required to raise the load and the distance of the effort from the fulcrum of a lever, given that the distance between the load and fulcrum remains unchanged?

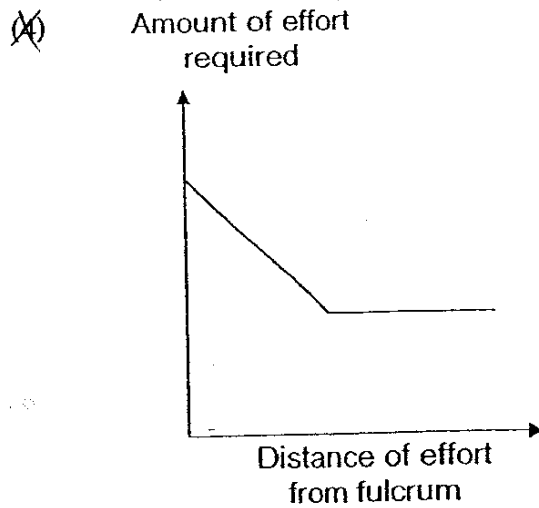
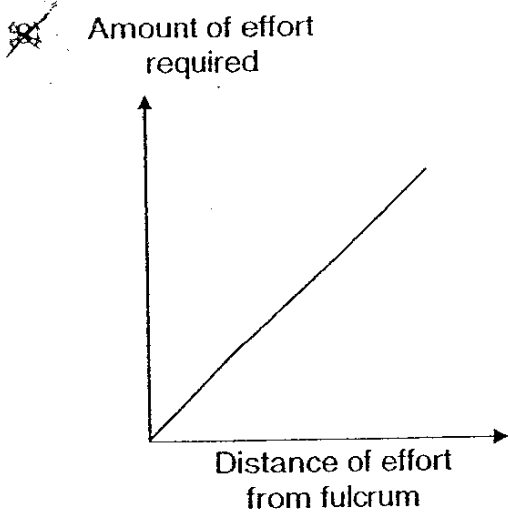
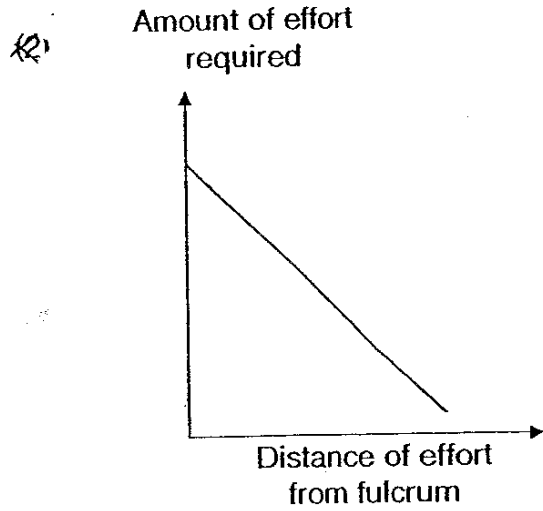
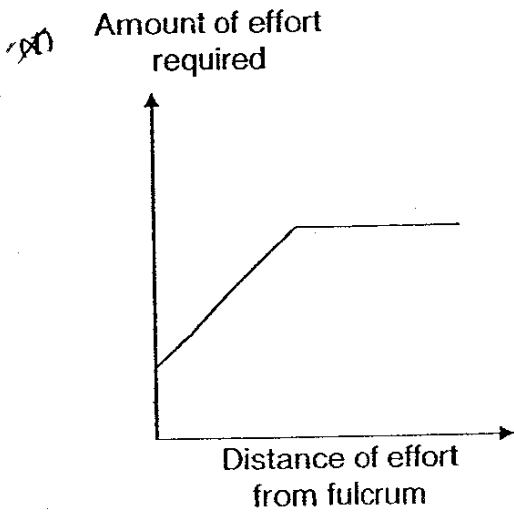

(66)

20. Four different loads W, X, Y and Z are being balanced using the lever systems as shown below.

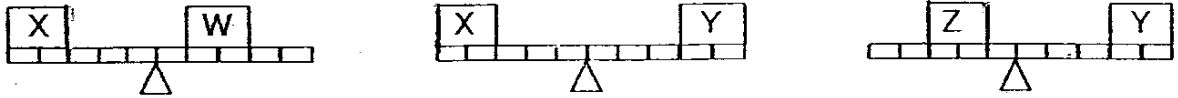

Which of the following diagrams correctly shows how loads W and Z are balanced on the lever?

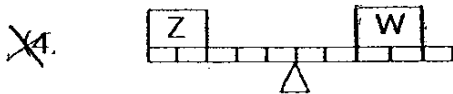
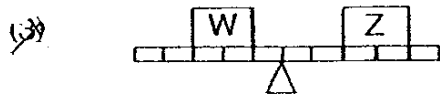
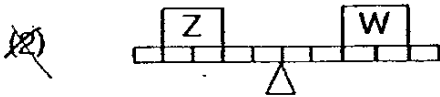
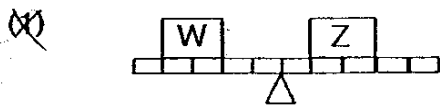

21. Ahmad uses a screwdriver to drive a screw into a block of wood as shown below.

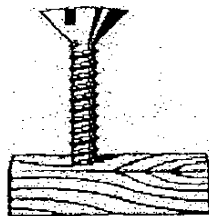

What type of simple machine(s) does/do the screw represent?

- ~~(A)~~ Inclined plane only
- ~~(B)~~ Lever and inclined plane only
- ~~(C)~~ Wheel and axle and lever only
- ~~(D)~~ Wheel and axle and inclined plane only

22. The diagram below shows a system of 4 gears, A, B, C and D.

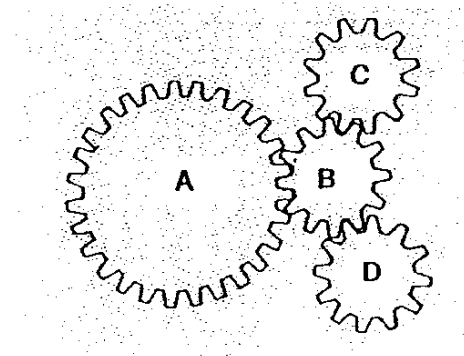

When the four gears start moving together, which one of the gears will move in a different direction from the other three gears?

- A
- B
- C
- D

23. Dave used two ramps, K and L, to raise an identical load up to the same height. He observed that the effort needed for ramp K was greater than the effort needed for ramp L. What possible conclusion(s) can he draw about the two ramps, K and L?

- A Ramp K is longer than ramp L.
- B Ramp L is less steep than ramp K.
- C The distance moved by the load using ramp L is shorter than the distance moved by the load using ramp K.
- D The distance moved by the effort using ramp K is shorter than the distance moved by the effort using ramp L.

- A B only
- B A and C only
- C B and D only
- D A, C and D only

24. The concept map below shows the characteristics of a simple machine.

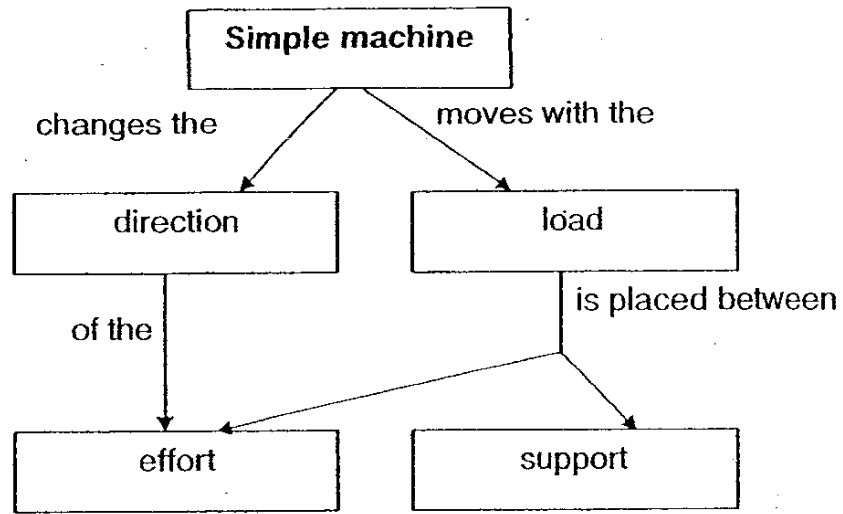

Which one of the following uses the type of simple machine as described in the concept map above?

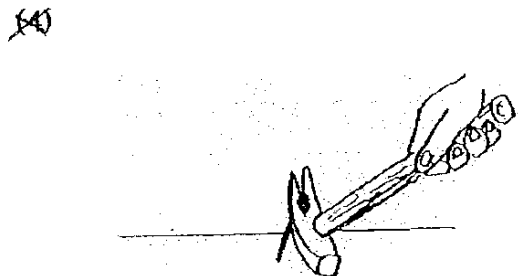
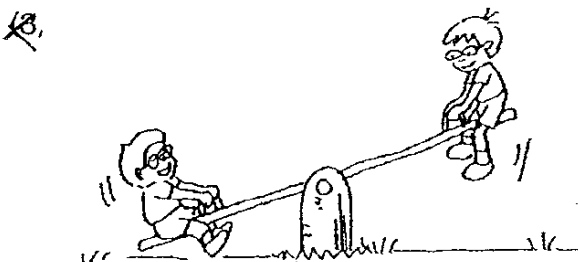
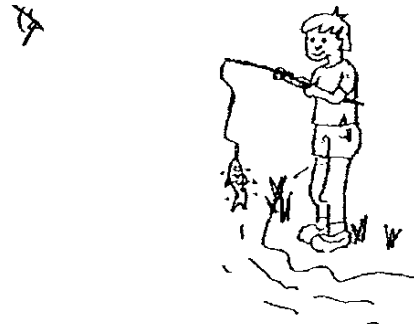
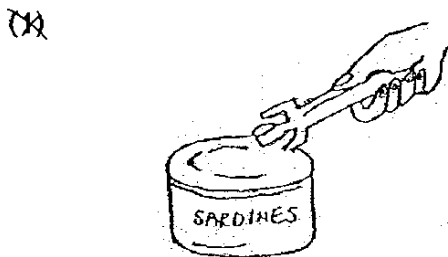

69

25. Study the circuits below.

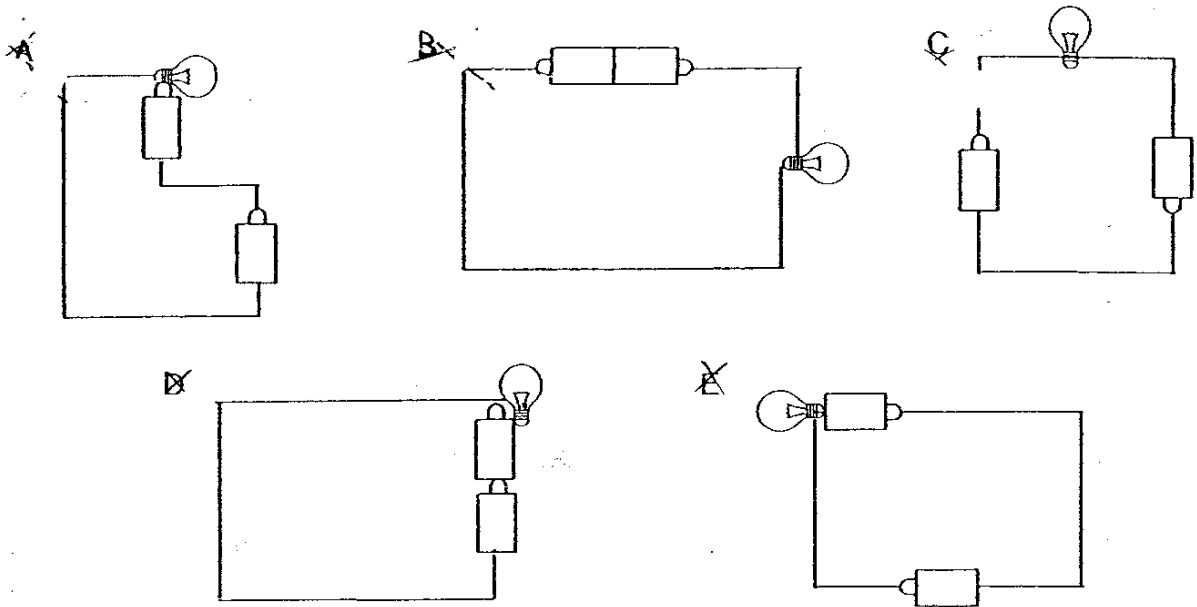

Which of the above circuits will light up?

- A and E only
- B and C only
- A, B and E only
- B, C and D only

26. Which one of the following correctly shows how the filament is connected in the metal casing of the light bulb?

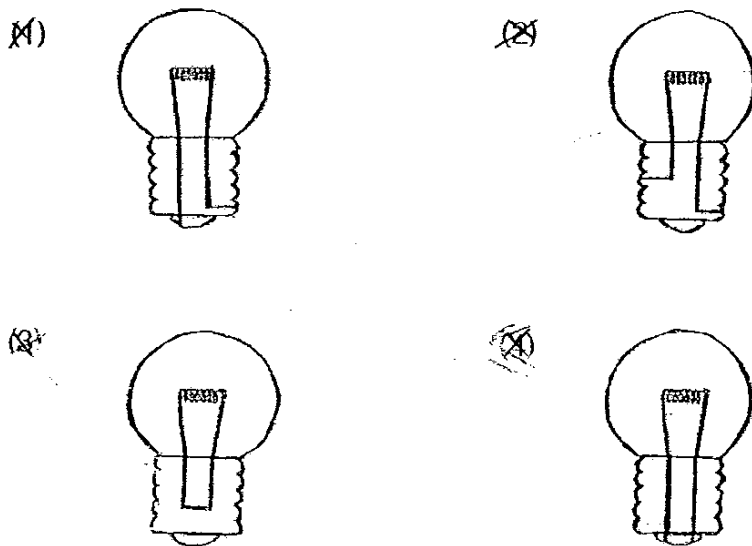

170

27. The diagram below shows 4 bells A, B, C and D in a circuit that is correctly connected.

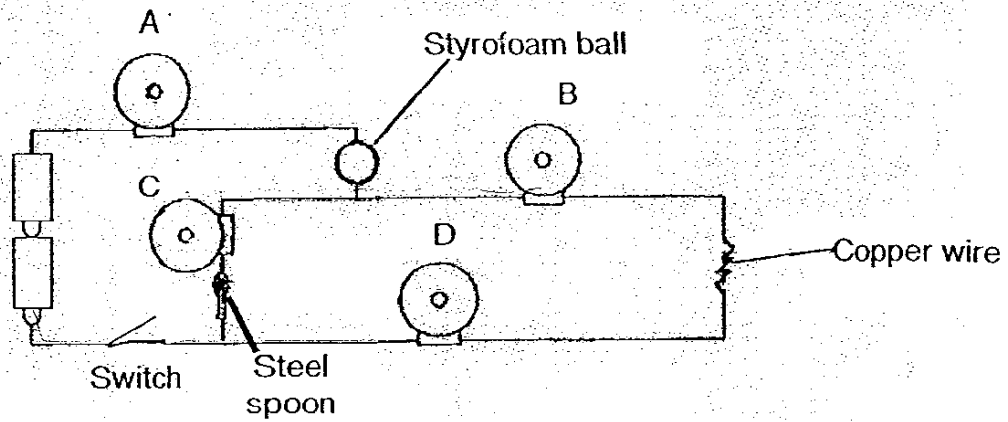

When the switch is closed, which of the bell(s) will ring?

- A and C only
- A, B and D only
- B, C and D only
- None of the bells

28. Four materials, A, B, C and D, were connected in the electrical circuit as shown below.

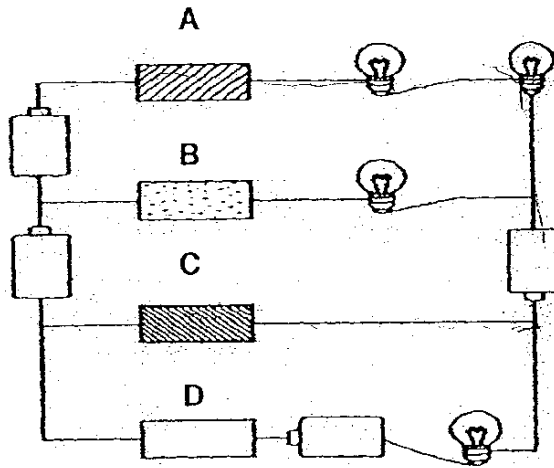

Which one of the following correctly represents the materials A, B, C and D in the electrical circuit so that only two of the bulbs will light up?

	Material A	Material B	Material C	Material D
<input checked="" type="checkbox"/>	Lead	Plastic	Steel	Porcelain
<input checked="" type="checkbox"/>	Brass	Glass	Ceramic	Copper
<input checked="" type="checkbox"/>	Plastic	Wood	Rubber	Gold
<input checked="" type="checkbox"/>	Iron	Porcelain	Glass	Nickel

271



29. Study the circuits shown below.

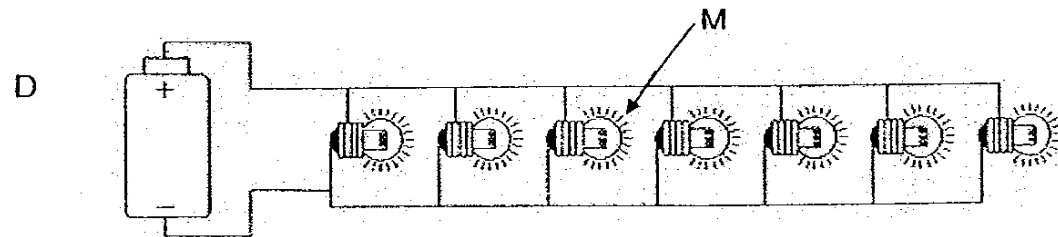
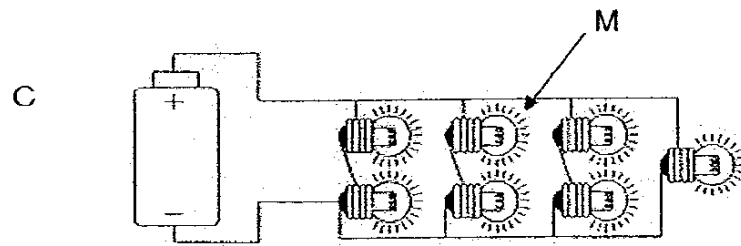
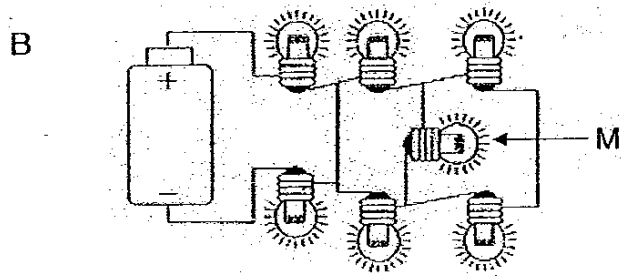
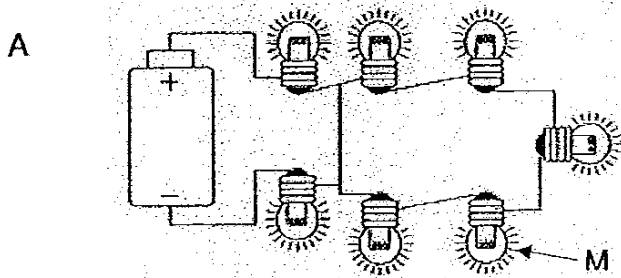

In which of the above circuits would the same number of bulbs continue to be lit when bulb M blows?

- A and B only
- A and C only
- B and D only
- C and D only

172

30. The diagram below shows four circuits with different arrangements of identical batteries and identical lamps. The bulbs in all four circuits are lighted up.

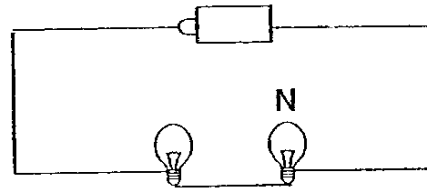
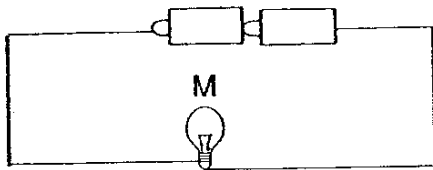
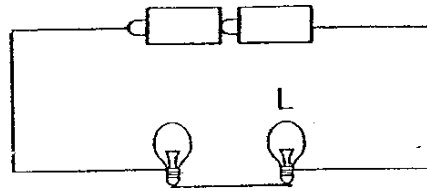
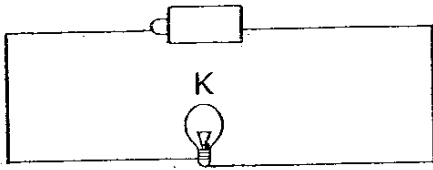

Which one of the following shows the brightness of the lamps, K, L, M and N?

	Brightness of lamp		
	Low	Medium	High
<del>(A)</del>	N	K	L
<del>(B)</del>	N	L	M
<del>(C)</del>	L	M	N
<del>(D)</del>	L	K	M

\*\*\*\*\*END OF BOOKLET A\*\*\*\*\*

173

**Section B : (40 marks)**

**Answer the following questions in the spaces provided.**

31. Joy was told by her teacher that a cell needed food, water and oxygen for growth. She performed the following steps in order to observe the multiplication process of some yeast cells.

- Step A : Fill a conical flask with 250ml of warm water.
- Step B : Add one table spoon of yeast and sugar and stir the mixture.
- Step C : Take 1 drop of mixture from conical flask and place it onto a specimen slide.
- Step D : Add one drop of methylene blue to the mixture.
- Step E : Place a cover slip over the specimen.

- (a) How did the adding of sugar to yeast in Step B help in the growth of the yeast cells?

---

- (b) What was the purpose of performing step D? (1 mark)

---

- (c) Joy placed a specimen on the stage of the microscope and focused it using the coarse focus knob. However, no matter how she turned, the coarse focus knob, she was unable to obtain a clear view of the reproduction process of yeast.

What should she do to obtain a clear, focused view of the multiplication process of yeast? (1 mark)

---

174



Name : \_\_\_\_\_ ( )

Class : Primary 5 \_\_\_\_\_

## CHIJ ST NICHOLAS GIRLS' SCHOOL



Primary 5

Second Semestral Assessment – 2007

SCIENCE

BOOKLET B

Total Time for Booklets A and B: 1 hour 45 minutes

16 questions  
40 marks

Booklet A	60
Booklet B	40
Total	100

Do not open this booklet until you are told to do so.  
Follow all instructions carefully.

\_\_\_\_\_  
Parent's Signature/Date

32. Study the circuit diagram.

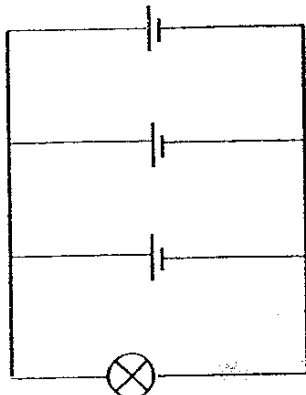

(a) Connect the batteries and the bulb below to form the circuit represented by the circuit diagram above. (1 mark)

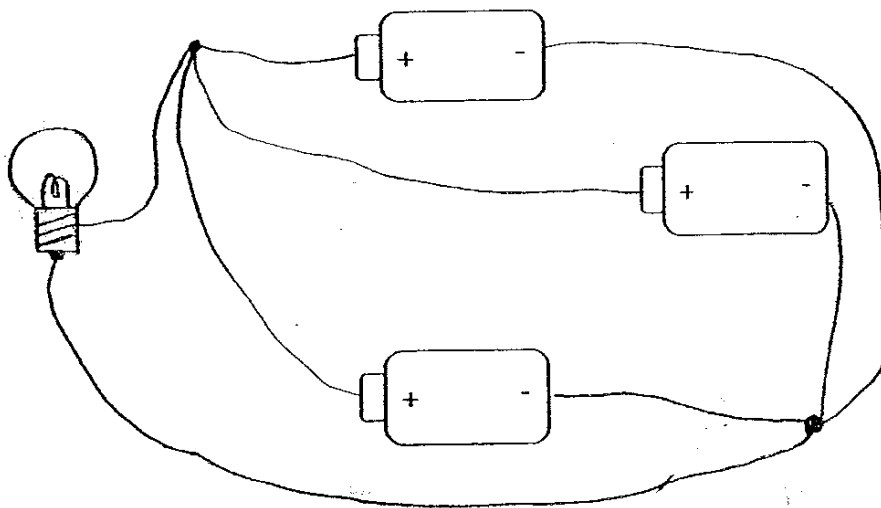

(b) State an advantage of using the above circuit. (1 mark)

176



33. Study the 2 circuits below carefully.

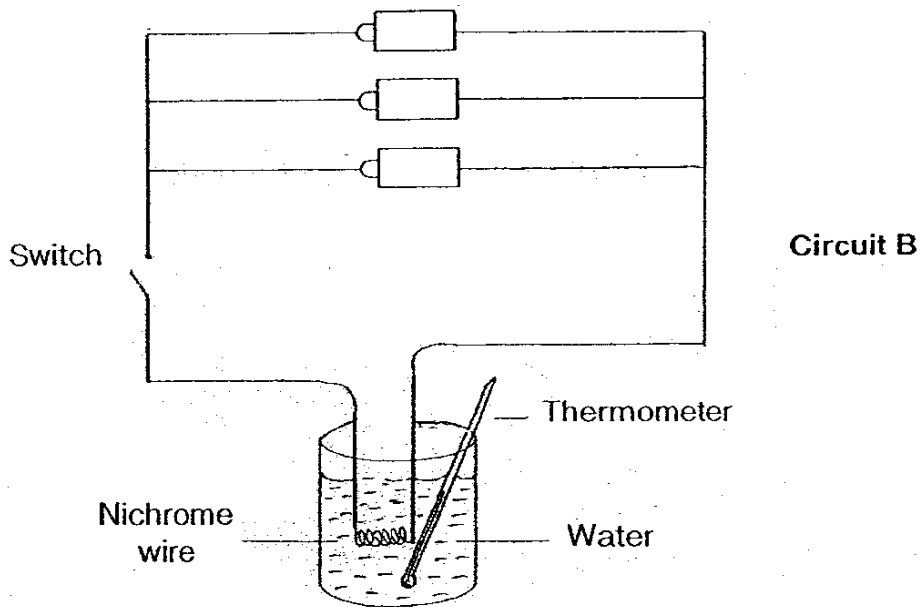
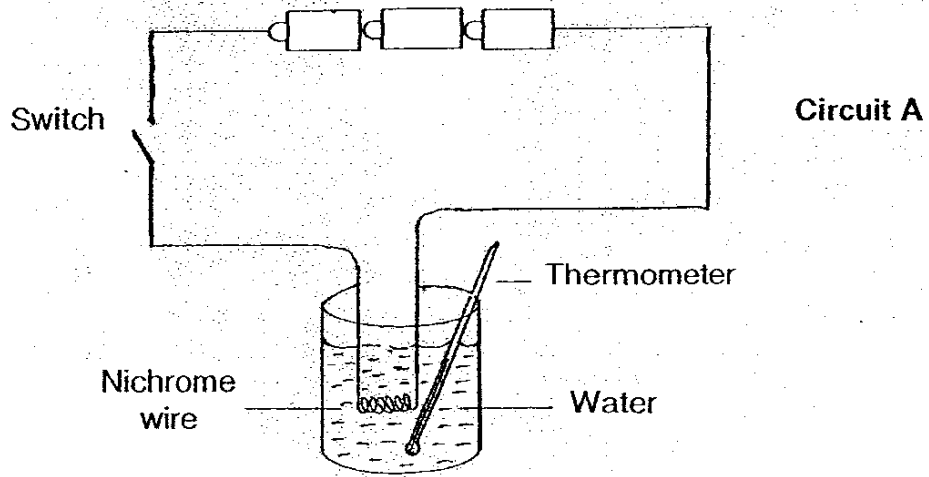

In which circuit will the water reach the boiling point first? Explain your answer clearly. (2 marks)

---

---

177

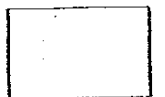

34. Johnny sets up the experiment to test the electrical conductivity of 4 objects R, S, T and U which are made of different materials.

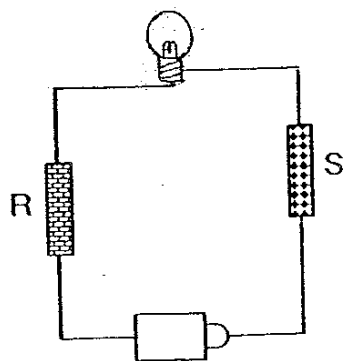

Setup A

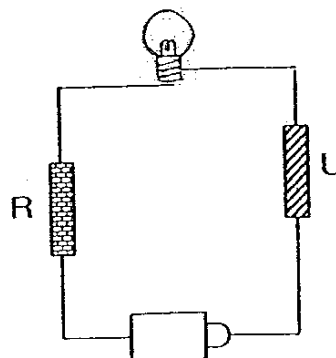

Setup B

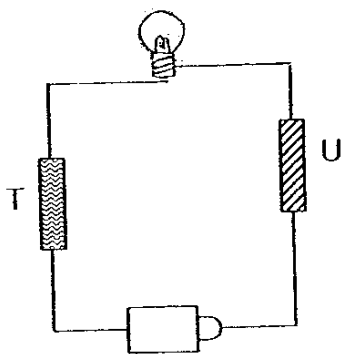

Setup C

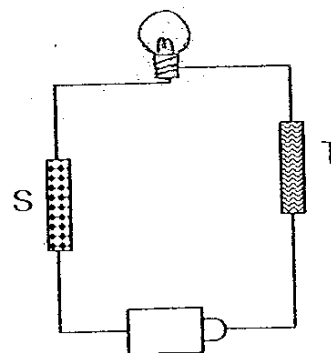

Setup D

The table below shows the results of the experiment.

Setup	Bulb lights up	Bulb does not light up
A	✓	
B		✓
C		✓
D	✓	

- (a) Which of the objects is/are not conductors of electricity? (1 mark)

- (b) Given that all the batteries and bulbs are in good working conditions, Johnny replaces objects R and U in setup B with iron and copper respectively. However, the bulb still does not light up. Suggest a possible reason for his observation. (1 mark)

178

35. Study the diagram of the Earth shown below.

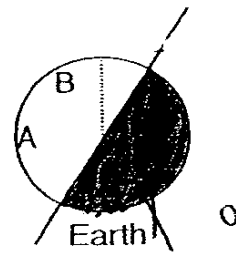
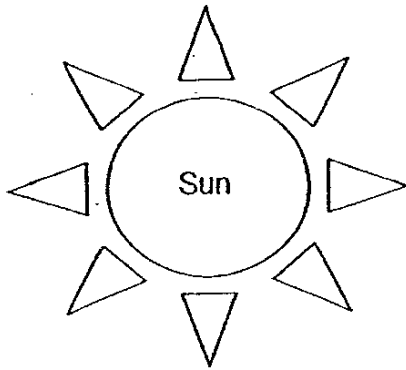

(a) Shade the part of the Earth which is experiencing night. (1 mark)

(b) What is the difference between the climate in Country A and B? Give a reason for your answer. (1 mark)

---



---

(c) How is the Earth's position from the Sun important for its ability to support a great diversity of life? (1 mark)

---



---

36. The diagram below shows two methods of reproduction.

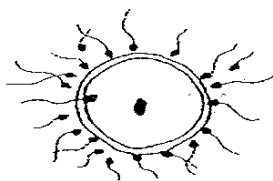

Method A

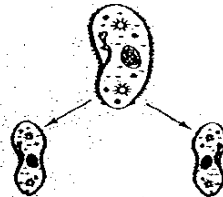

Method B

Which method of reproduction will reproduce young that are exactly like their parents? Explain your answer clearly. (2 marks)

---



---

179

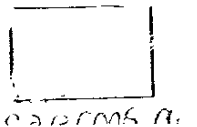



37. Study the flow chart below.

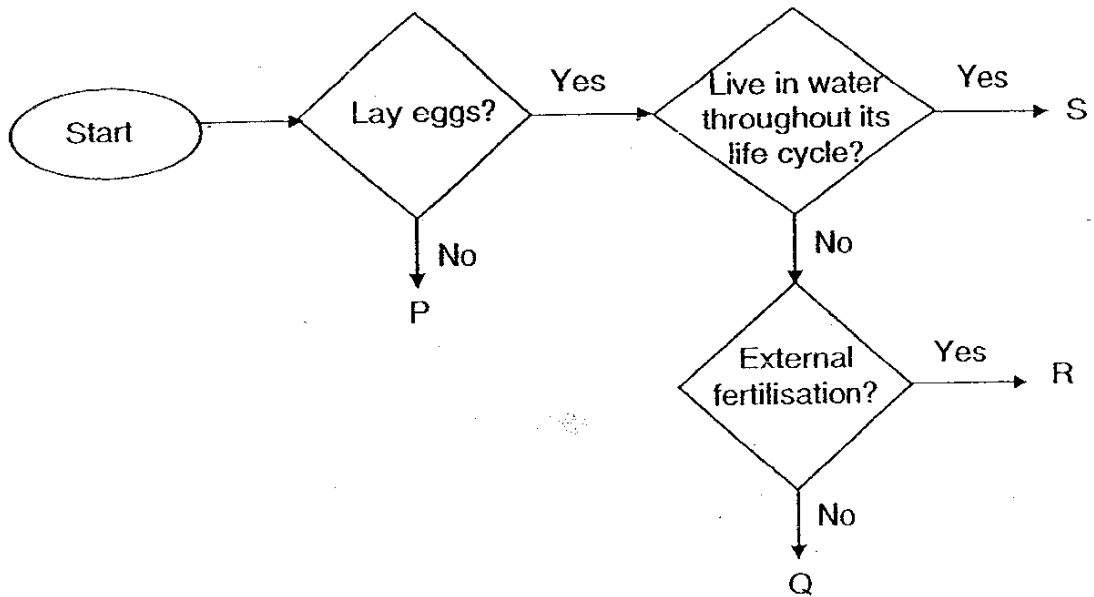

(a) Identify the exit points, P, Q, R and S for the following organisms. (1 mark)

(i) Mosquito : \_\_\_\_\_

(ii) Salmon : \_\_\_\_\_

(b) State a similarity between the organisms in R and S. (1 mark)

\_\_\_\_\_

180



38. The diagram below shows a single-celled organism called Chlamydomonas which lives in pond water.

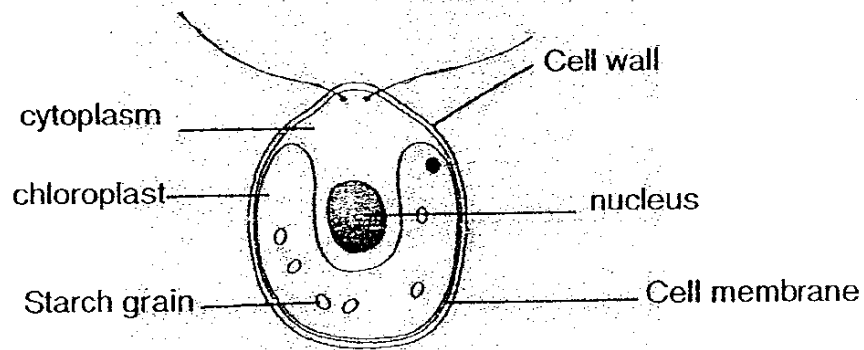

- (a) State two features of the Chlamydomonas which show that it is more likely to be a plant cell than an animal cell. (1 mark)

---

- (b) What is the function of the nucleus in Chlamydomonas? (1 mark)

---

Another Cell H was taken from a multicellular organism and viewed under the microscope. It looked slightly different from the Chlamydomonas as shown in the diagram below.

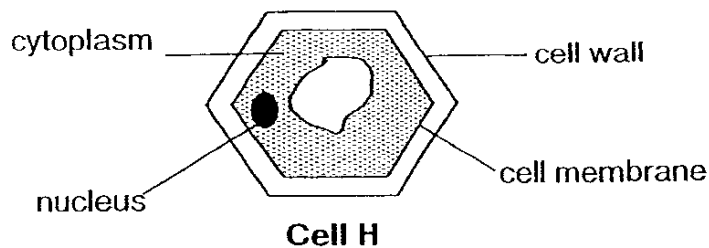

- (c) Based on observation, state the difference between the cells in the single-celled and multicellular organisms. (1 mark)

---

- (d) Which part of the multicellular organism could Cell H be taken from?

---

487

3

39. The diagrams below show the fruits of the Rose of India tree and the Peacock tree.

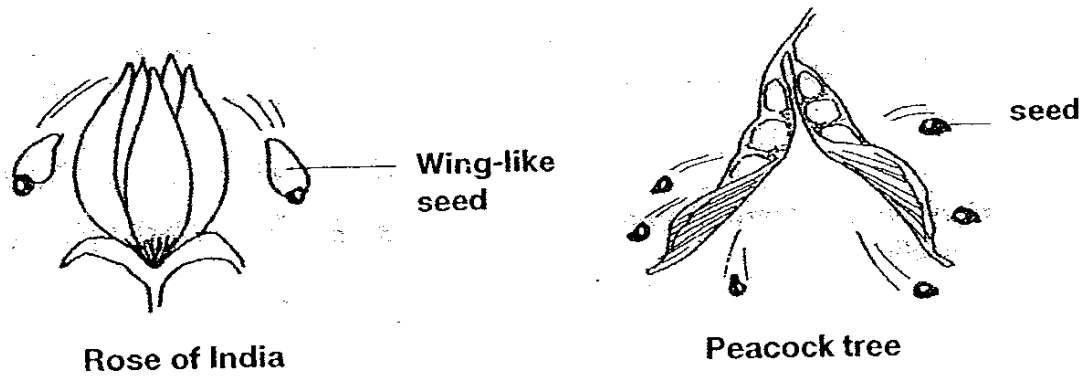

Both fruits split open when they are ripe to disperse their seeds.

- (a) Which fruit would disperse its seeds nearer to its parent plant? Give a possible reason by comparing the physical characteristics of the seeds.

---

- (b) What is a possible disadvantage of the dispersal method of the fruit as stated in your answer in (a). (1 mark)

---

182



40. Fatimah sets up an experiment to investigate the conditions that are necessary for seeds to germinate. She prepares 3 setups, X, Y and Z as shown below and leaves them in a sunlit room with a temperature of 40°C.

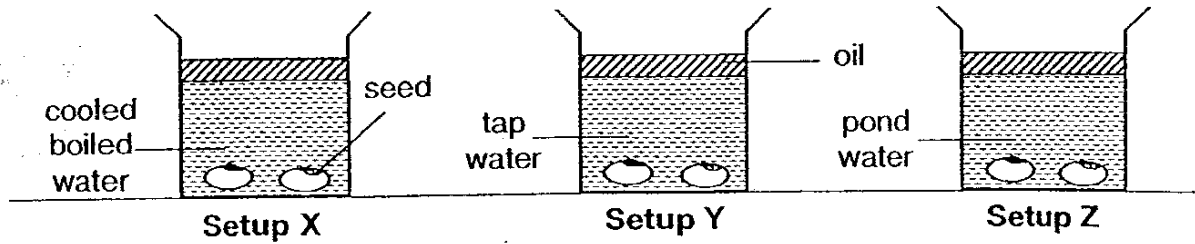

- (a) State the conditions which are necessary for the germination of seed.

---

- (b) In which setup(s) will Fatimah observe the germination of seeds? Explain your answer clearly. (1 mark)

---

---

- (c) Why does Fatimah add a layer of oil to the beakers of water? (1 mark)

---



41. Study the diagram of the flower below carefully.



(a) Indicate , using an arrow, the part where "pollination" takes place. (1 mark)

(b) Why is pollination important to the plant? (1 mark)

---

(c) Based on the diagram above, why do you think the male parts of the flower are hanging out? (1 mark)

---

---

180



42. A rope snaps when a load of 60kg is hung from it. This rope is used in all the pulley systems L, M and N below. All the pulleys have a weight of 1kg.

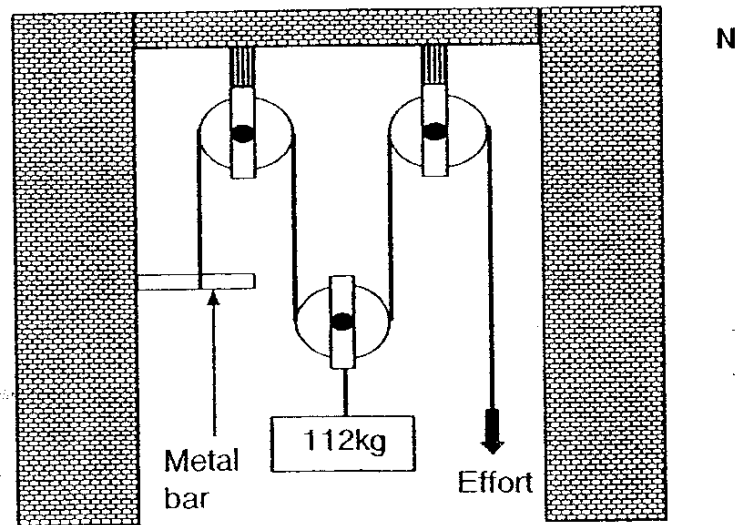
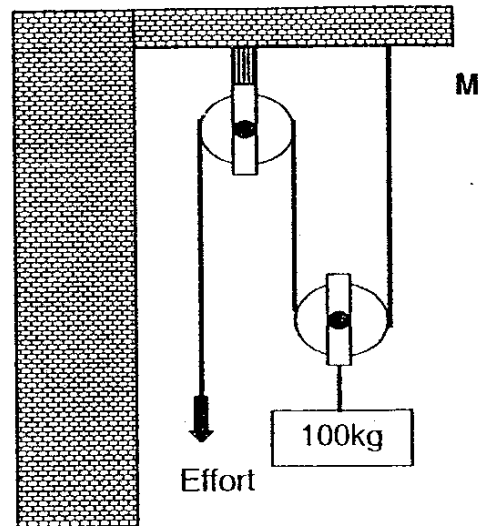
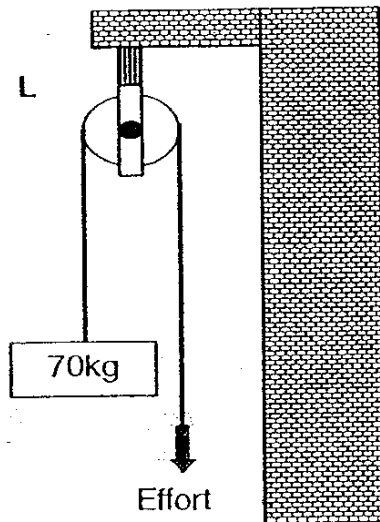

- (a) In which of the above pulley system(s) would the rope be able to support the load? (1 mark)

- (b) Explain your answer for (a). (1 mark)

185



43. Study the diagram below carefully.

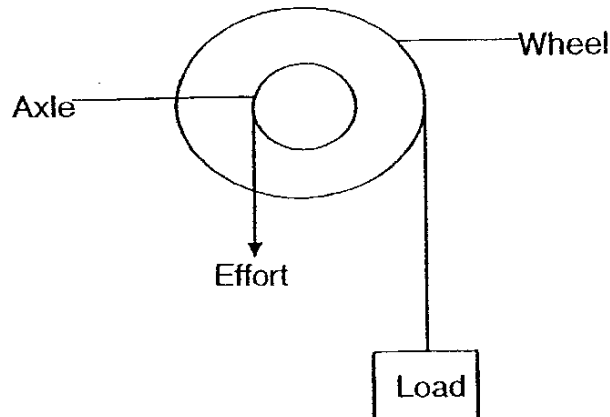

Without changing the positions of the effort and load, suggest two changes that can be made to the wheel and axle so as to reduce the effort needed to lift the load. (2 marks)

- (a) \_\_\_\_\_
- (b) \_\_\_\_\_

44. Ahmad conducted an investigation on 3 types of simple machines and recorded the following results.

Simple Machine	Load (g)	Effort (g)	Distance travelled by load (cm)	Distance travelled by effort (cm)
W	30	50	15	8
X	40	20	6	15
Y	60	35	16	8

(a) Which simple machine W, X or Y uses the same principle as a fishing rod? Give a reason for your answer. (1 mark)

\_\_\_\_\_

\_\_\_\_\_

(b) Ahmad's teacher told him that he had made a mistake in recording the result for one of the simple machines. Identify the simple machine and explain your answer clearly. (2 marks)

\_\_\_\_\_

\_\_\_\_\_

186



45. Study the graph below carefully.

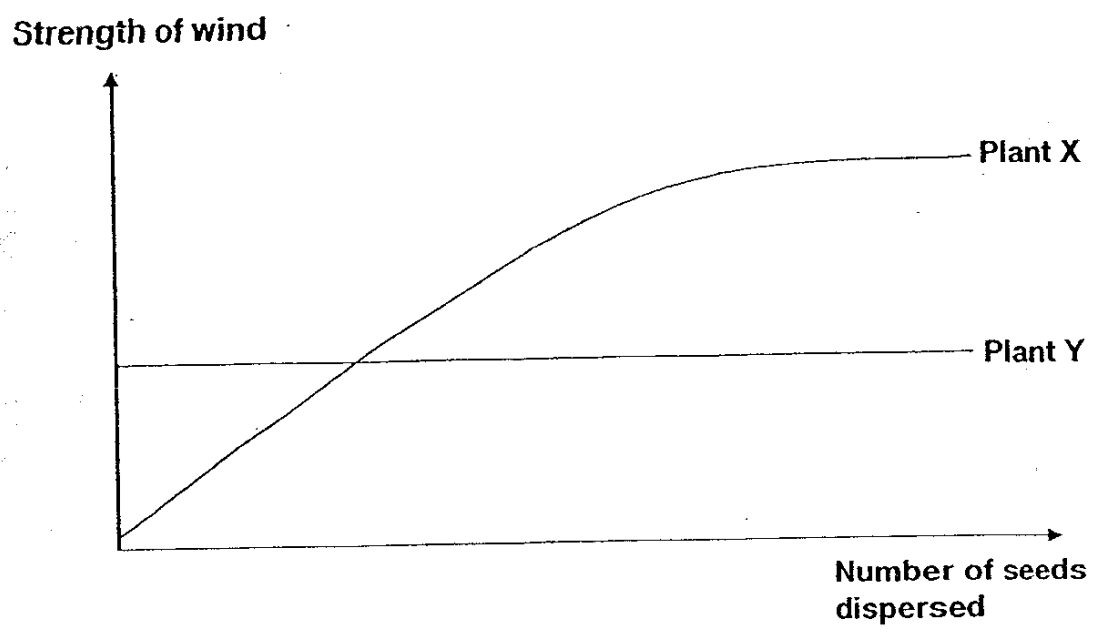

(a) Based on the graph above, what can you conclude about the relationship between the number of seeds dispersed from Plants X and Y and the strength of the wind? (2 marks)

---

---

(b) List two characteristics of the seeds from Plant X. (1 mark)

---

---

187

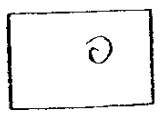



46. Natalie lives in a HDB flat. One day, she helps her grandmother to put out some clothes to dry. Her grandmother asks Natalie to hang the heavier clothes on the inner end of the bamboo pole so that she can put out the bamboo pole more easily.

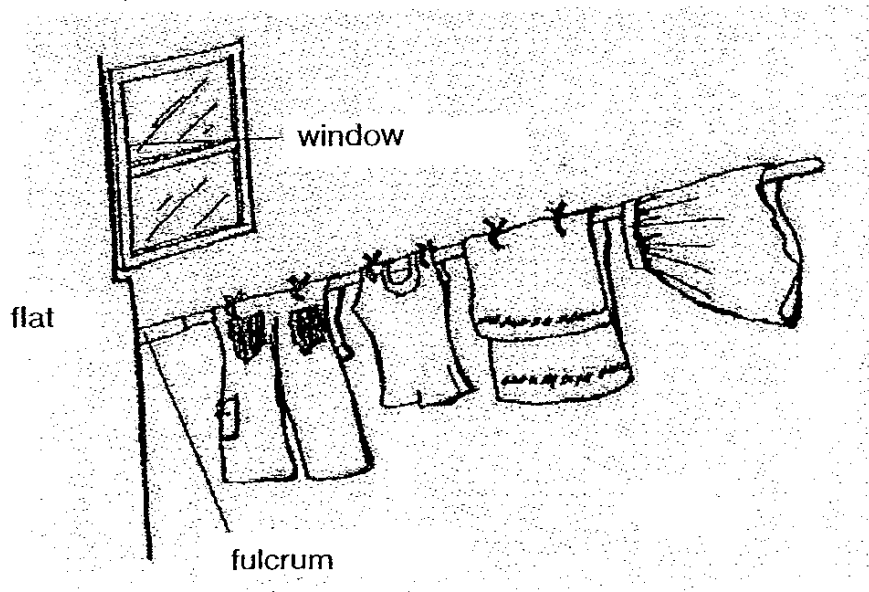

What do you think is her grandmother's reason for saying so?

(2 marks)

---

---

\*\*\*\*\*END OF PAPER\*\*\*\*\*

188

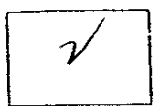

# CHIJ Primary School

## Primary 5 Science SA2 Exams (2007)

### Answer Keys

#### SECTION A : (60 MARKS)

Qn no.	Ans
1	4
2	3
3	4
4	1
5	4
6	2
7	2
8	2
9	3
10	3

Qn no.	Ans
11	4
12	2
13	2
14	3
15	4
16	1
17	3
18	1
19	2
20	2

Qn no.	Ans
21	4
22	2
23	3
24	1
25	1
26	1
27	4
28	1
29	3
30	2

#### SECTION B (40 MARKS)

- 31a. Sugar is the food for the yeast.  
31b. It stains the yeast cells and allows her to see more clearly under a microscope.  
31c. She could adjust the fine focus knob.

32a.

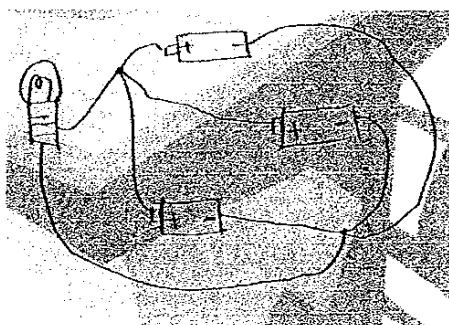

- 32b. When one battery is not working the rest of the two batteries will still help the bulbs light up.  
33. Circuit A. The batteries are arranged in series so the current is more.  
34a. U and S.  
34b. The wires are wronging connected

35a.

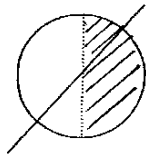

35b. Country B cooler than A.

35c. If the Earth is too near the sun it would be too hot, as all the water on earth would dry and we will die, and it is too far, it would be too cold and the water will freeze and will die.

36. The cell splits into Z identical, each containing the same genetic materials. The meeting of the sperms and the egg fuse two node as which contains different genetic material.

37a.(i) Q

(ii) S

37b. Both lay eggs

38a. It has chloroplast and the cell wall.

38b. It controls the activity in the wall

38c. Single- celled organism has chloroplast and starch grain but cell-it dose not have.

38d. Root/ petal / underground stems.

39a. The peacock fruit. The seed of rose of India has wing-like structure so it may fly away from the adult plant, but the seeds of peacock tree do not have wing-like structure.

39b. It might form overcrowding.

40a. It needs air, water and warmth.

40b. Y and Z. The seeds have oxygen, water and warmth.

40c. It is to prevent oxygen in the air from entering the water.

41a.

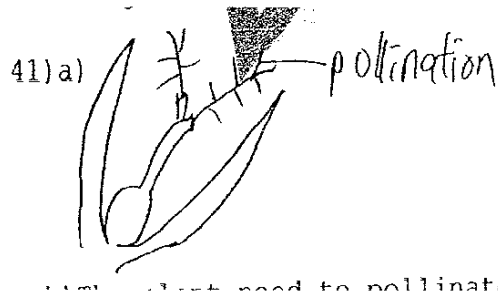

... just need to pollinate

41b. The plant need to pollinate in order for the plant to reproduce in to a fruit and dispersed to ensure their kind not to be extinct.

41c. Male parts are sticking out so as to allow the pollen grains to be carried away more easily by the wind to other flower.

- 42a. **Pulley system M and N**  
42b. **As long as there is a movable pulley the load is reduce by half, but the fixed pulley the effort is equal to the load.**
- 43a. **Decrease the size of the wheel**  
43b. **Increase the size of the axle**
- 44a. **Effort is not reduce and the load travels greater distance than the effort.**  
44b. **Since effort is not reduce, the distance moved by effort should be longer.**
- 45a. **The greater the strength of the wind ,more seeds from plants X will ,more seeds from plant X will be dispersed up to a certain point where the number of seed dispersed is not dependent on the strength of the wind. The strength of the wind dose not effect the number of seeds dispersed by Y.**  
45b. **It is light and wing-like structure.**
46. **The heavier the load is nearer to the fulcrum, so effort is used.**