



RAFFLES GIRLS' PRIMARY SCHOOL

SEMESTRAL ASSESSMENT (2) 2009

Practical 10%	Your score out of 100	
Section A 50%		
Section B 40%		
	Class	Level
Highest score		
Average score		
Parent's signature		

Name : _____ Index No: _____ Class: P 5 _____

30th Oct 2009

SCIENCE

Attn: 1h 30min

SECTION A (25 X 2 marks)

For each question from 1 to 25, four options are given. One of them is the correct answer. Make your choice (1, 2, 3 or 4). Shade the correct oval on the Optical Answer Sheet.

1. The diagrams below show the life cycles of two organisms, X and Y.

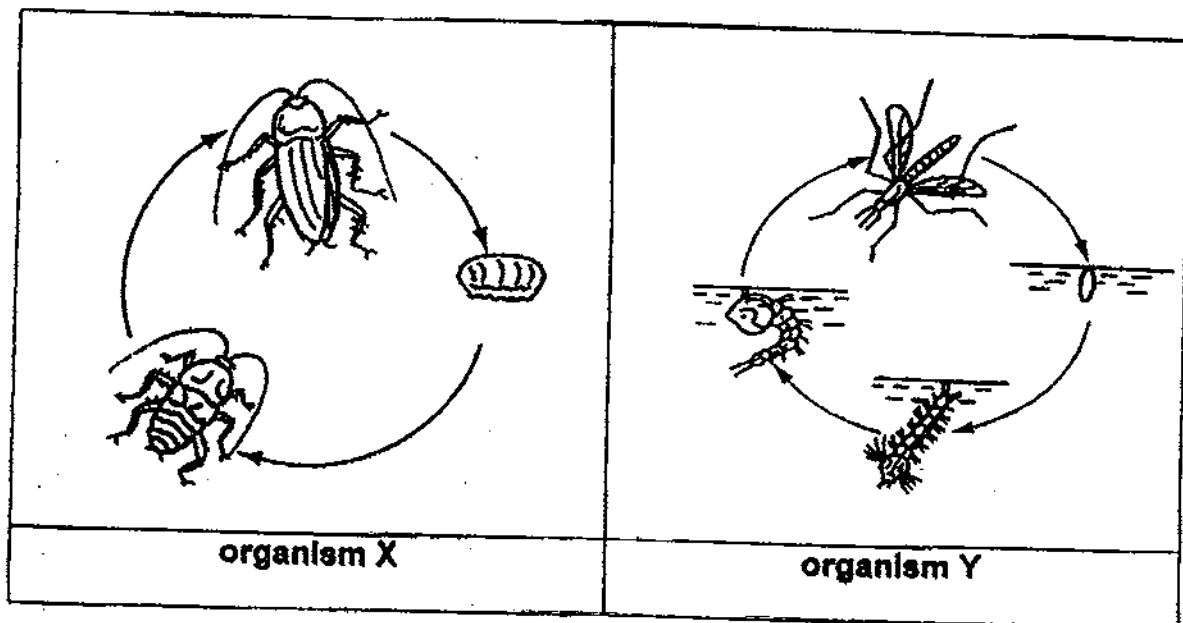

Which of the following statements about organisms X and Y is/are correct?

- A Both organisms lay their eggs in water.
- B Both organisms have six legs at the adult stage.
- C Both organisms have 4 stages in their life cycles.
- D The young of both organisms look like the adult.

- (1) B only
- (2) A and B only
- (3) C and D only
- (4) A, B and C only

2. Sarah's science teacher brought in two fruits, X and Y, for her pupils to examine.



animals

fruit X

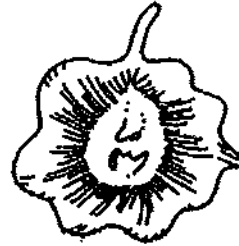

wind

fruit Y

Sarah noted down her observations as shown below.

Fruit X is sweet-smelling, fleshy and juicy.

Fruit Y is light and has thin paper-like edges.

Which one of the following shows correctly how fruits X and Y are being dispersed?

	fruit X	fruit Y
(1)	by wind	by splitting
(2)	by water	by splitting
(3)	by animal	by wind
(4)	by splitting	by water

3. The diagram below shows Ann's family tree.

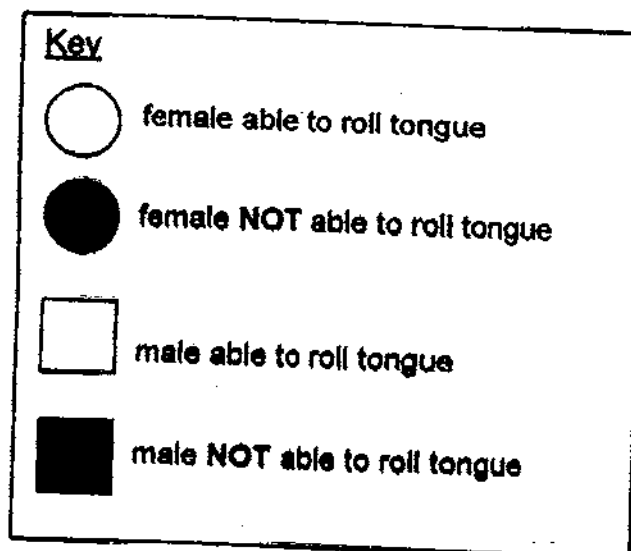
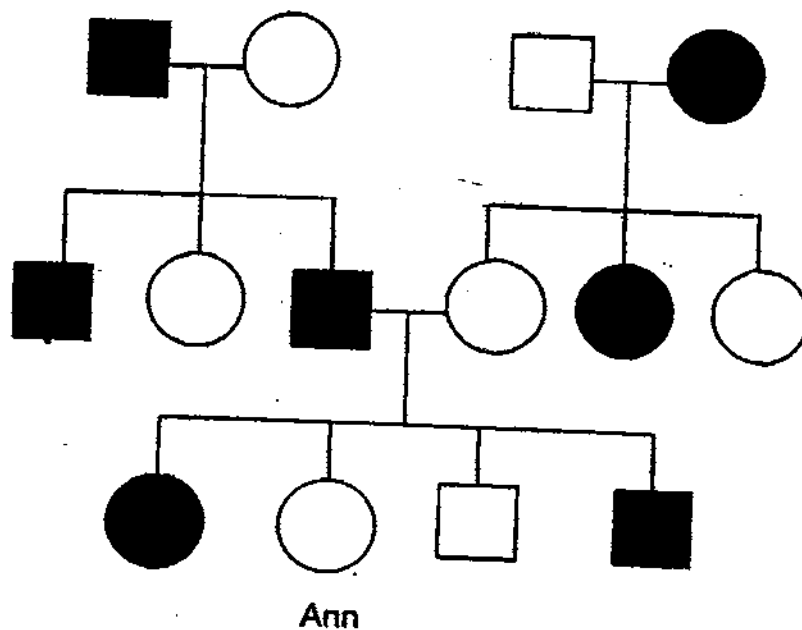

Based on the information above, which of the following statements are true?

- A Ann has three siblings.
- B Ann has three cousins.
- C Ann has one uncle and three aunts.
- D Ann inherited the characteristics of tongue rolling from her aunts.

- (1) A and C only
- (2) B and C only
- (3) B and D only
- (4) A, C and D only

4. Nurul put an equal number of seeds in 5 identical containers, P, Q, R, S and T. She left each container at a different place with a different temperature. She gave the same amount of water to each pot everyday. She measured and recorded the average height of the seedlings in each container after 1 week as shown in the table below.

container	P	Q	R	S	T
amount of water (ml)	10	10	10	10	10
average temperature of surrounding (°C)	5	18	30	40	70
average height of seedlings (cm)	1	5	10	18	0

Based on the information given above, which one of the following statements is correct?

- (1) The average height of the seedlings in pot R is the tallest.
 - (2) For seeds to germinate, the right amount of warmth needs to be present.
 - (3) The greater the amount of warmth the seed receives, the taller the seedling.
 - (4) A seedling given 10 ml of water will grow as tall as the seedlings in container R and S.
5. The diagrams below show the male and female reproductive systems.

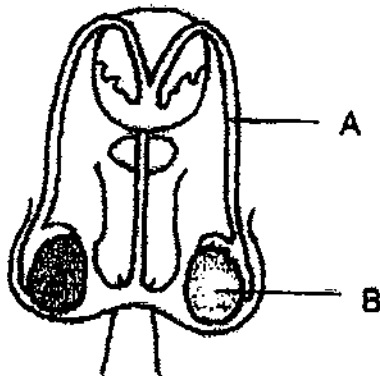

male

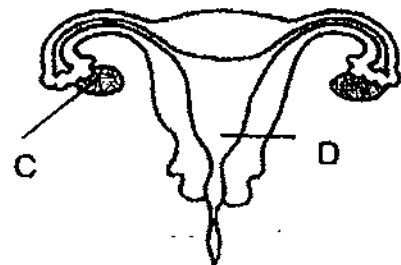

female

In which of these parts are the sperms and eggs produced?

	sperms	eggs
(1)	A	C
(2)	A	D
(3)	B	C
(4)	B	D



6. The diagram below shows parts of a plant.

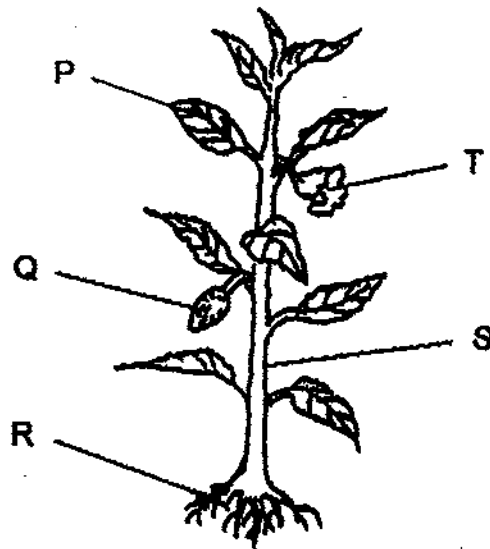

Plants require sunlight, water and carbon dioxide to photosynthesise.

Which of these plant parts help it to carry out photosynthesis?

- (1) P and T only
- (2) P, R and S only
- (3) P, R and T only
- (4) Q, R and S only

Two similar plants were each placed in a transparent glass jar with an equal amount of water. Both set-ups were placed near the window. The amount of oxygen present in each of these jars was measured by an instrument, X, over a period of 12 hours as shown in the diagrams below.

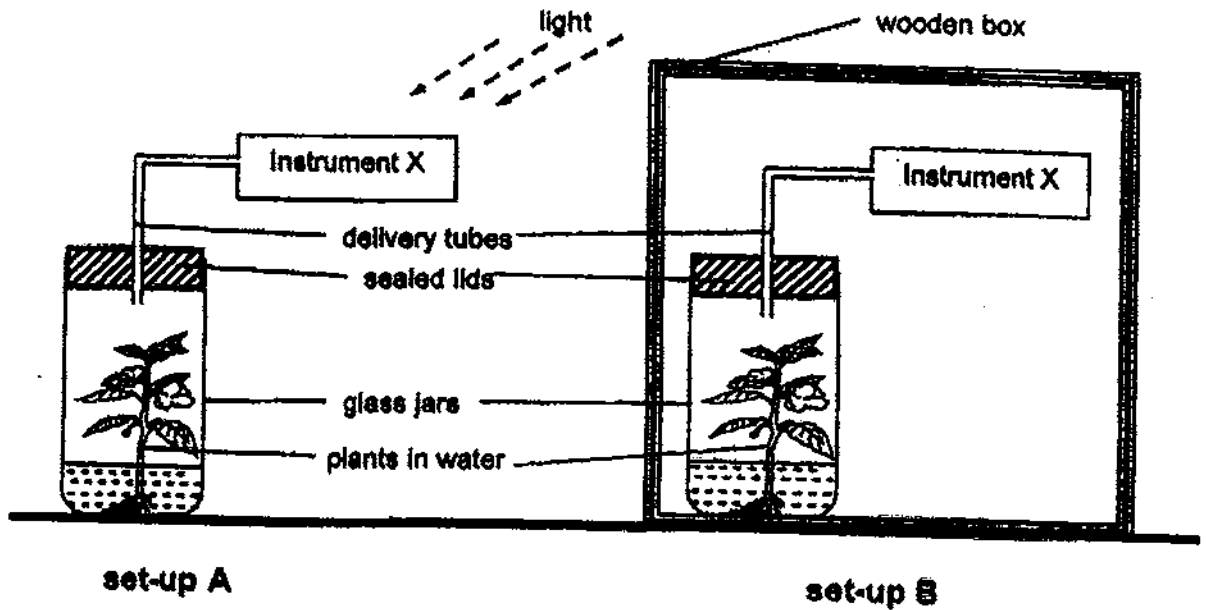

Based on the information above, answer **questions 7 and 8**.

7. Which one of the following graphs shows correctly the amount of oxygen present in each of these set-ups from 7am to 6pm?

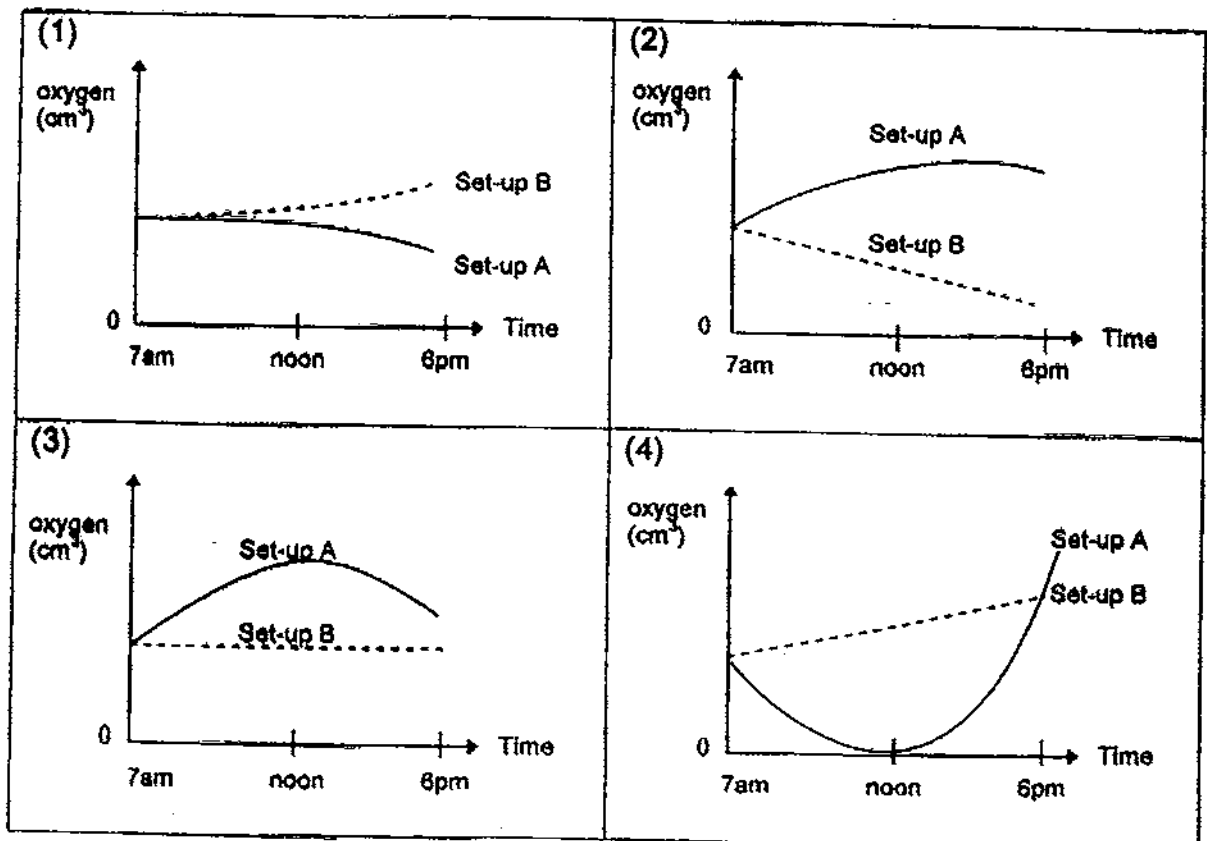

8. Why is it NOT advisable to have too many potted plants in a hospital room?

- (1) The plants may produce gases that are harmful.
- (2) The plants release too much oxygen into the air during photosynthesis.
- (3) The plants compete for oxygen with the patients in the absence of light.
- (4) The plants take in too much carbon dioxide from the air during photosynthesis.

9. Nutrients are transported from the digestive system to different parts of the body. In which part of the digestive system does this process take place?

- (1) gullet
- (2) stomach
- (3) small intestine
- (4) large intestine

10. Which of the following body systems aid(s) in the release of energy a body needs to carry out daily activities?

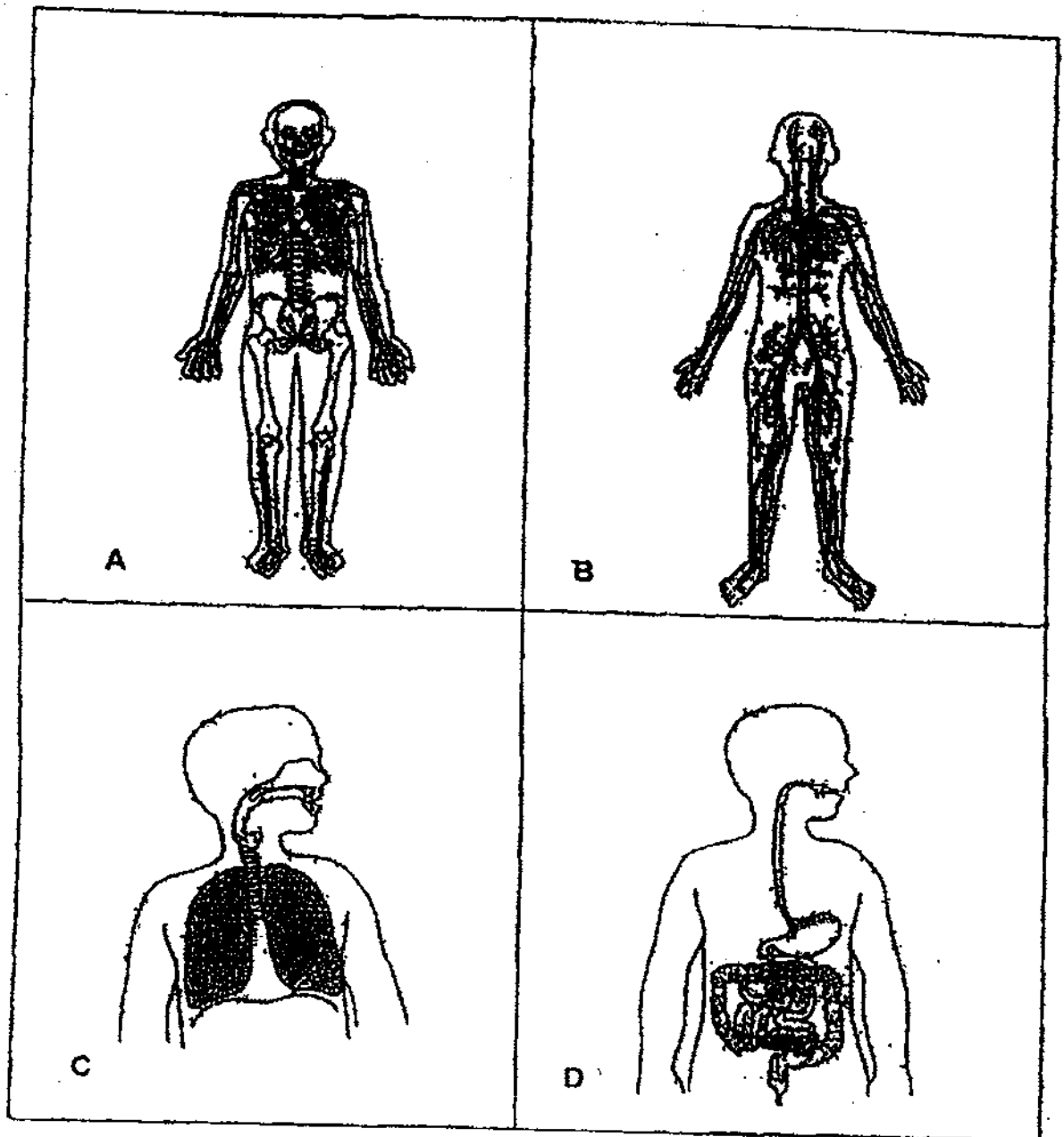

- (1) B only
- (2) D only
- (3) A and B only
- (4) B, C and D only

11. The diagram below shows some cells from the surface of a leaf.

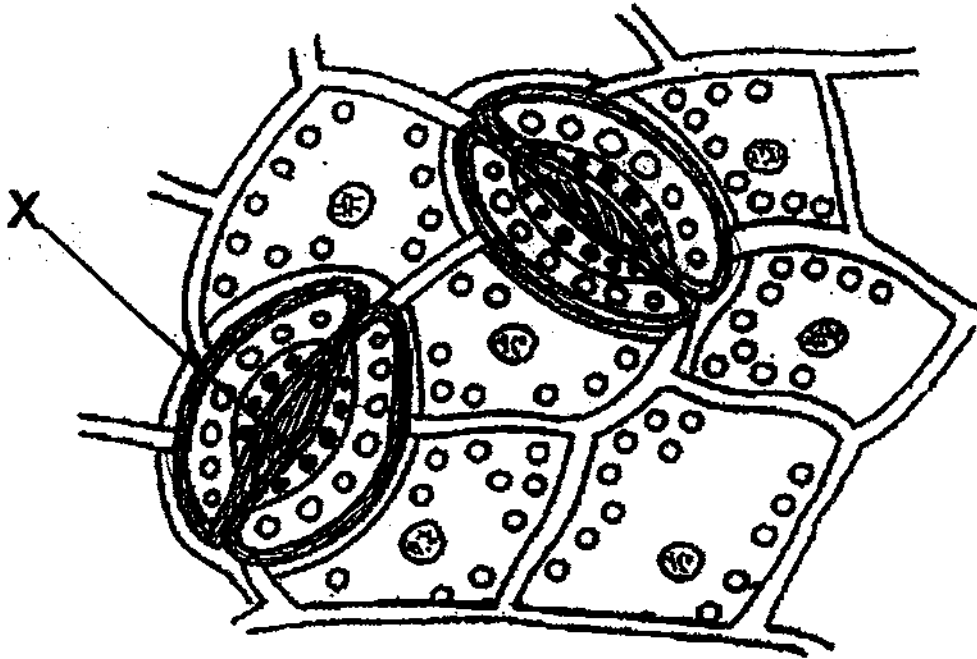

The part marked 'X' is the tiny opening which is found mostly on the undersides of leaves.

Which of the following are the functions of X?

- A They take in water.
 - B They photosynthesise.
 - C They give out oxygen.
 - D They absorb sunlight.
 - E They take in carbon dioxide.
-
- (1) A and B only
 - (2) C and E only
 - (3) B, C and D only
 - (4) B, D and E only

12. Sulin put two similar balsam plants into each of the jars as shown below.

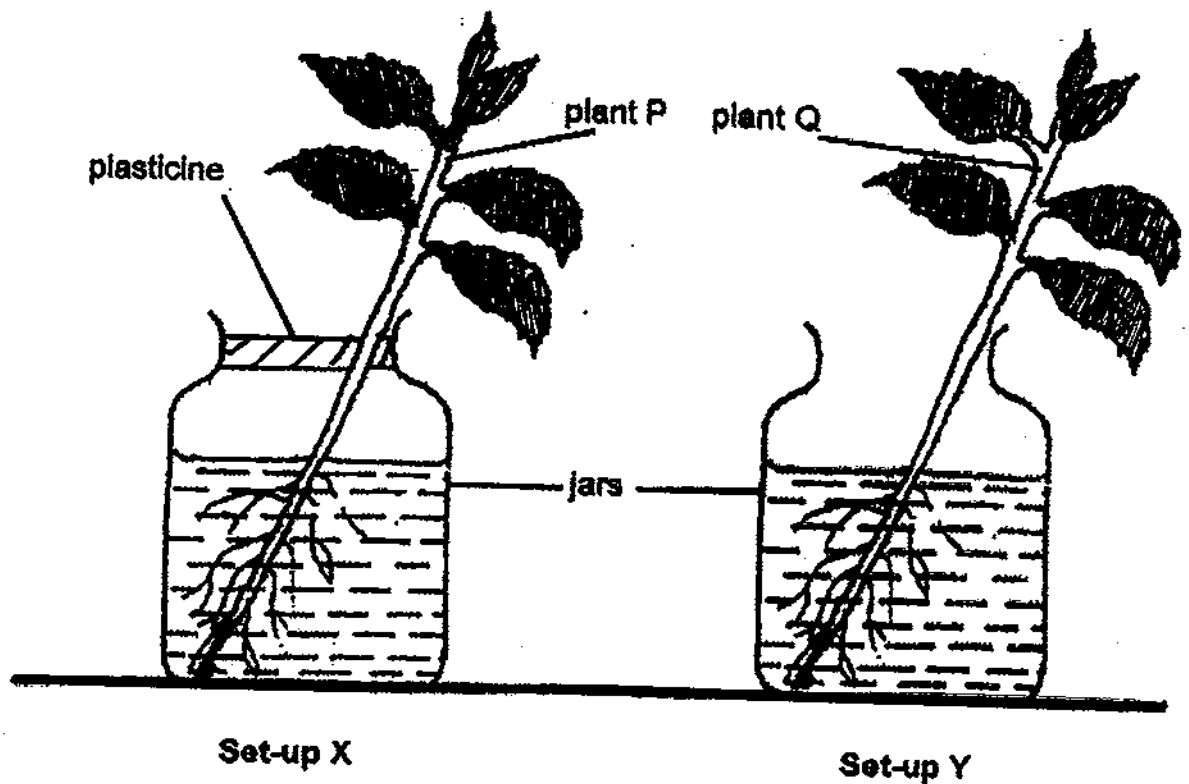

Sulin left the jars near the window.

After a week, she noticed that the water level in Set-up Y was lower than the water level in Set-up X.

This is because _____

- A Plant P could not take in any water
 - B Plant Q had taken in more water than Plant P
 - C some water had condensed in the jar where Plant P was
 - D some water had evaporated from the jar where Plant Q was
-
- (1) B and D only
 - (2) C and D only
 - (3) A, B and C only
 - (4) B, C and D only

13. Some pupils wanted to find out if a plant takes in water through its roots. They set up the experiment as shown in the diagram below.

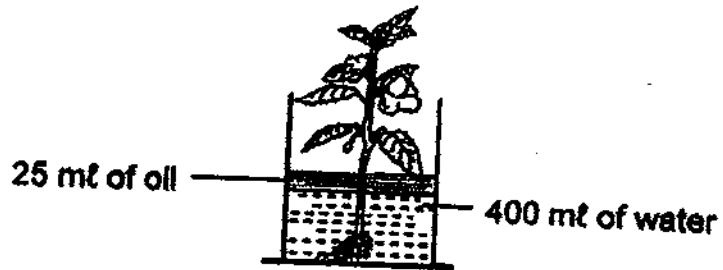

The pupils left the set-up in an open ground for a few days.

Which one of the following set-ups should be used as a control in their experiment?

<p>(1)</p> <p>400 ml of water</p>	<p>(2)</p> <p>400 ml of water</p>
<p>(3)</p> <p>300 ml of water</p>	<p>(4)</p> <p>25 ml of oil</p> <p>400 ml of water</p>

14. The diagram below shows Mary blowing a trumpet.



Which one of the following describes correctly what happens to her ribcage, diaphragm and chest when she blows into the trumpet?

	ribcage	diaphragm	chest
(1)	move in and downwards	move downwards	becomes bigger
(2)	move in and downwards	move upwards	becomes smaller
(3)	move out and upwards	move downwards	becomes bigger
(4)	move out and upwards	move upwards	becomes smaller

15. Some pupils placed an equal number of freshwater fish of the same kind in 5 similar tanks.

They wanted to find out if the temperature of water would affect the rate of movement of the gill covers of the fish.

The results are shown in the table below.

group	temperature of water (°C)	average rate of movement of gill covers per minute
A	18	15
B	20	25
C	22	30
D	24	50
E	26	60

Which one of the following labelled axes (X and Y) should be used to show the relationship between the two variables?

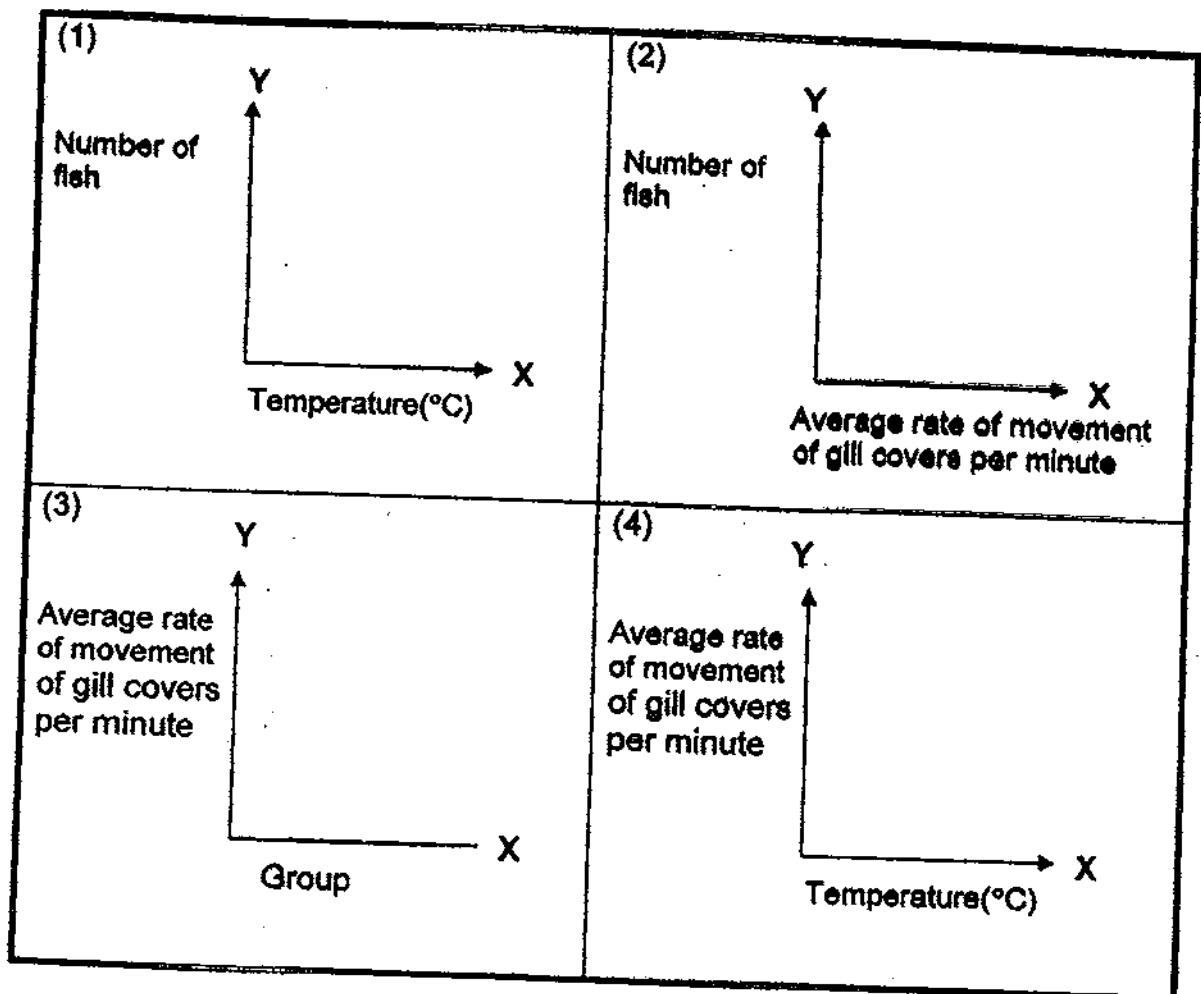

16. Jerry heated a beaker of water at room temperature for 10 minutes. He measured the temperature of the water every 2 minutes. He recorded his results in the graph show below.

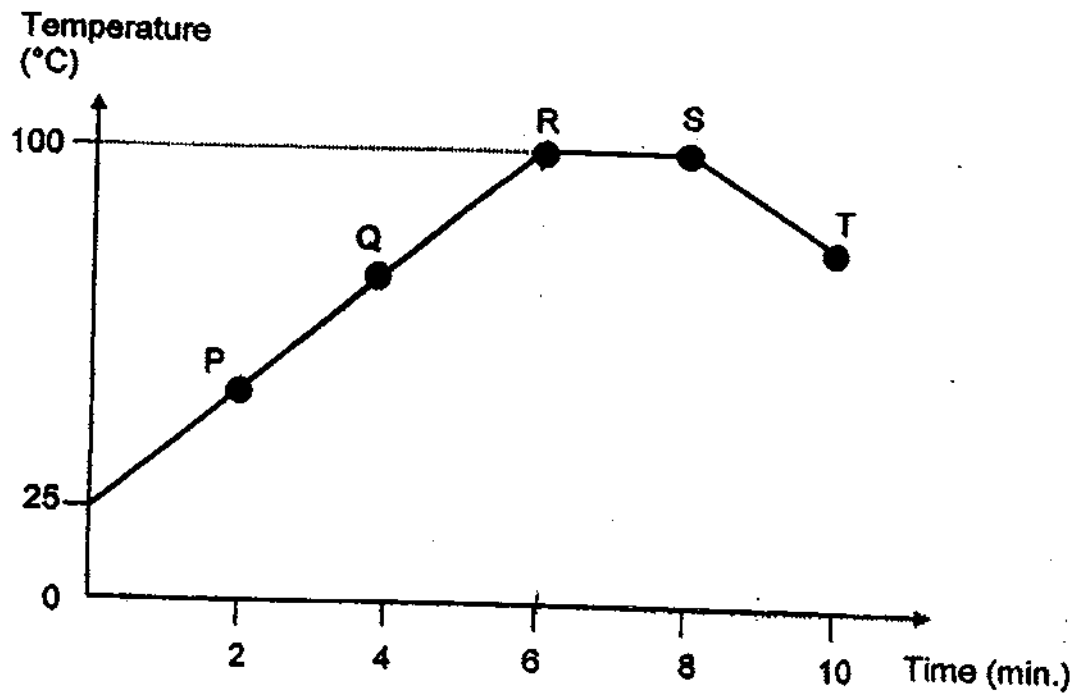

Based on the information above, which of the following statements are true?

- A The water was boiling from P to R.
 - B The water was boiling at the 6th minute.
 - C Evaporation only occurred during the period, RS.
 - D The initial temperature of the water was about 25°C.
-
- (1) A and B only
 - (2) A and C only
 - (3) B and D only
 - (4) A, B, C and D

17. Raju wanted to find out if the temperature of the surroundings affects the rate of evaporation of water.

Raju poured an equal amount of water into each of the four containers, A, B, C and D as shown below.

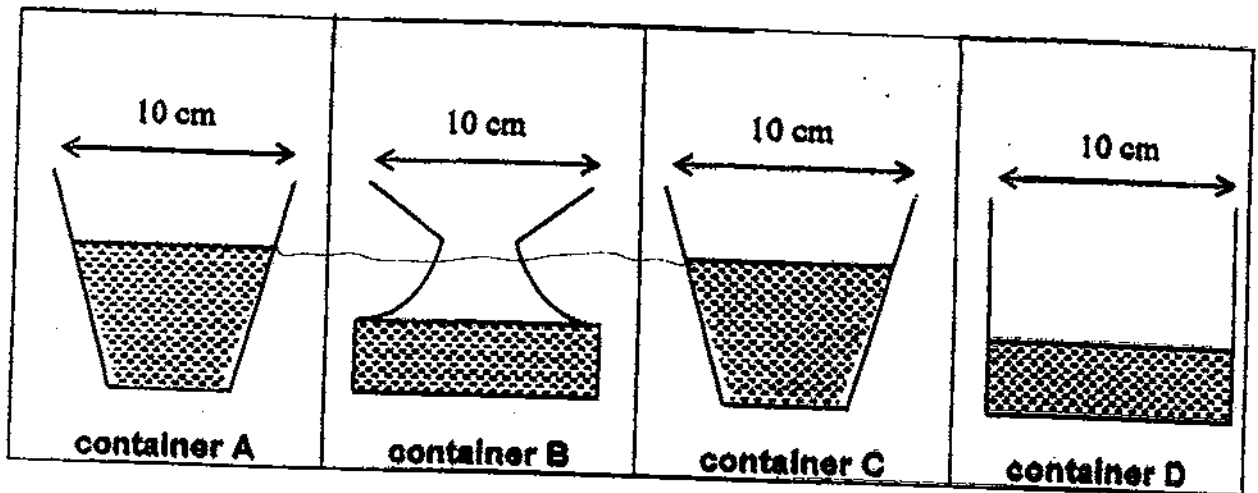

Each container was put in a different place of a different temperature as shown in the table below.

	container A	container B	container C	container D
temperature of surrounding (°C)	30	50	70	90
material of container	metal	plastics	metal	metal

Which of these containers should Raju choose to ensure that his experiment is a fair one?

- (1) A and C only
- (2) B and D only
- (3) A, C and D only
- (4) A, B, C and D

18. The diagram below shows a torch shining directly on a porcelain mug with its handle facing the screen.

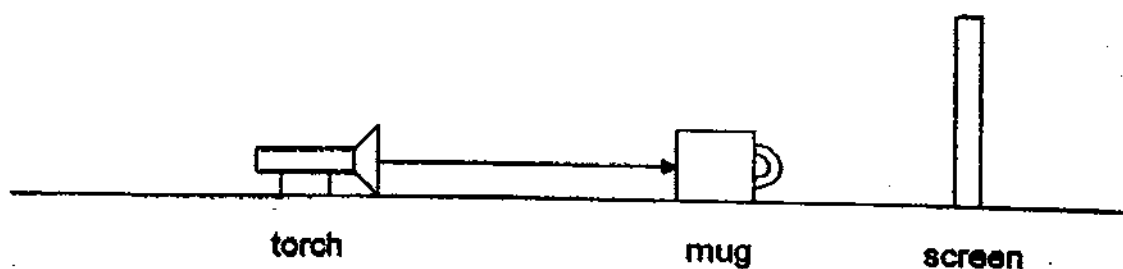

What can be done to increase the size of the shadow of the mug?

- (1) move the torch closer to the mug
 - (2) move the screen closer to the mug
 - (3) move the mug closer to the screen
 - (4) move the torch further away from the mug
19. A delivery tube containing a drop of red ink connects two flasks, X and Y, as shown below.

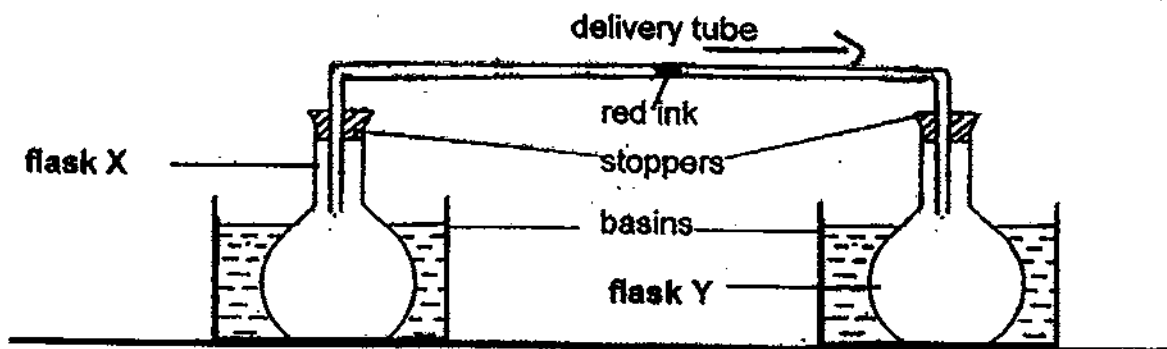

Which one of the following pairs of set-ups will cause the drop of red ink in the delivery tube to move towards flask Y?

	flask X is placed in a basin of	flask Y is placed in a basin of
(1)	water at 90 °C	ice water
(2)	ice water	water at 80 °C
(3)	water at room temperature	water at 90 °C
(4)	ice water	water at room temperature

20. Some materials are grouped as good conductors and bad conductors of heat as shown in the table below.

copper	wood
aluminium	plastics

Which one of the following explains correctly why a warm hand feels colder when one group of these materials is touched?

- (1) Bad conductors of heat transfer heat to the hand more quickly.
 - (2) Good conductors of heat transfer heat to the hand more quickly.
 - (3) Bad conductors of heat transfer heat away from the hand more quickly.
 - (4) Good conductors of heat transfer heat away from the hand more quickly.
21. The diagram below shows an electric circuit with four identical bulbs, A, B, C and D, and four switches, S1, S2, S3 and S4.

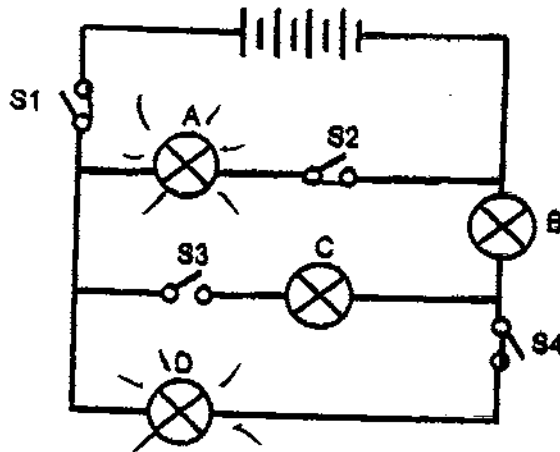

What is the least number of switches that must be closed to light up bulbs A and D?

- (1) 1
- (2) 2
- (3) 3
- (4) 4

22. Alan set up the electric circuit using the various components as shown in the diagram below.

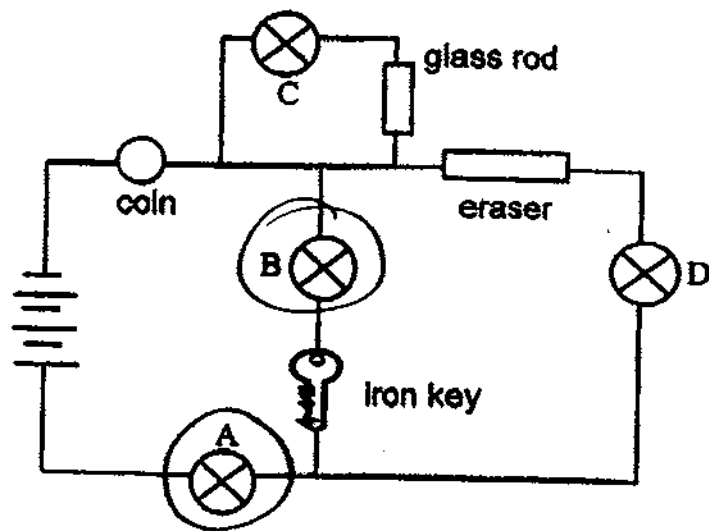

Which of these bulbs would light up in the circuit?

- (1) A and B only
- (2) C and D only
- (3) A, B and C only
- (4) B, C and D only

23. Each of the following circuits, A, B, C and D, uses identical batteries, wires and bulbs.

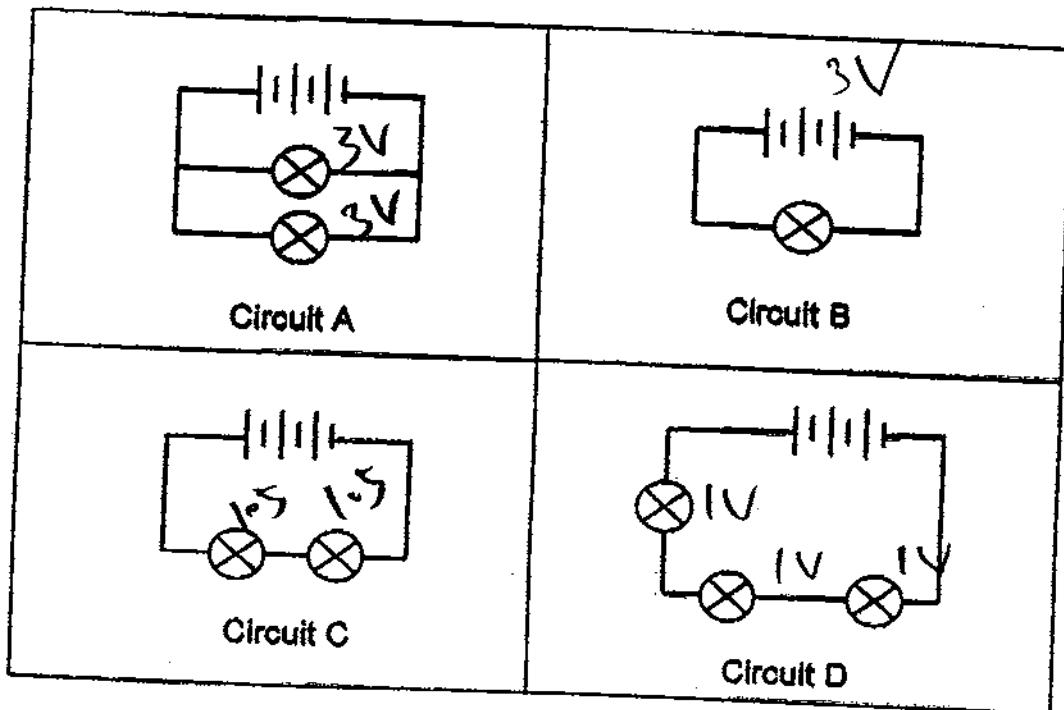

The following statements are made about the circuits above.

- Statement W : The bulbs in circuit A are dimmer than the bulbs in circuit D
- Statement X : The bulb in circuit B is brighter than the bulbs in circuit C.
- Statement Y : The bulbs in circuit A and C have the same brightness.
- Statement Z : The bulbs in circuit C and D have the same brightness.

Which of the following statements is/are correct?

- (1) X only
- (2) X and Y only
- (3) Y and Z only
- (4) W, Y and Z only

24. Wallace had three rods, X, Y and Z, each made of a different material. He placed them at positions 1, 2 and 3 respectively in an electric circuit as shown below.

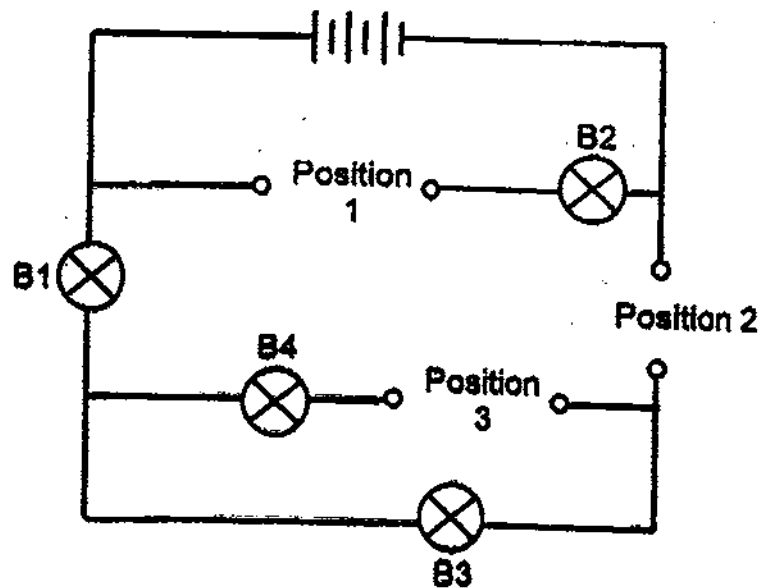

He recorded his observations in the table below.

position of each rod			Did the bulbs light up?			
1	2	3	B1	B2	B3	B4
X	Y	Z	yes	yes	yes	no

Which one of the following observations matches correctly to the positions of the rods in the circuit?

	position of each rod			Did the bulbs light up?			
	1	2	3	B1	B2	B3	B4
(1)	X	Z	Y	no	no	yes	yes
(2)	Z	X	Y	no	yes	yes	yes
(3)	Y	Z	X	yes	no	yes	no
(4)	Z	X	Y	yes	no	yes	yes

25. Kevin used a strong bar magnet to conduct the following experiment.

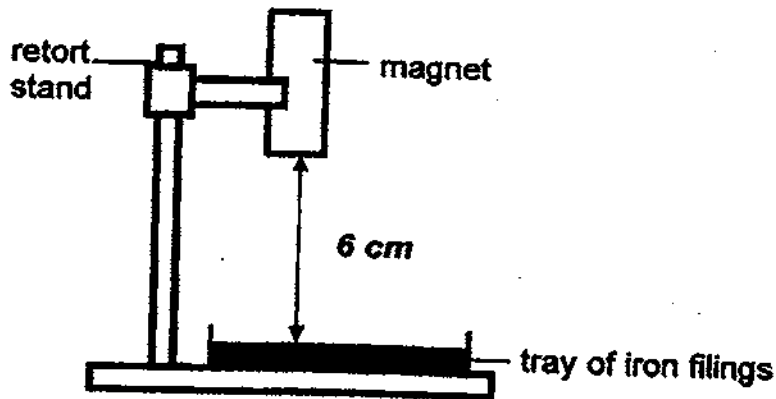

Kevin placed the magnet 6 cm away from the tray of iron filings. He measured and recorded the mass of iron filings attracted to the magnet.

He conducted the experiment three more times. However, the distance between the magnet and the tray of iron filings was decreased each time.

Which one of the following graphs is the best representation of Kevin's findings?

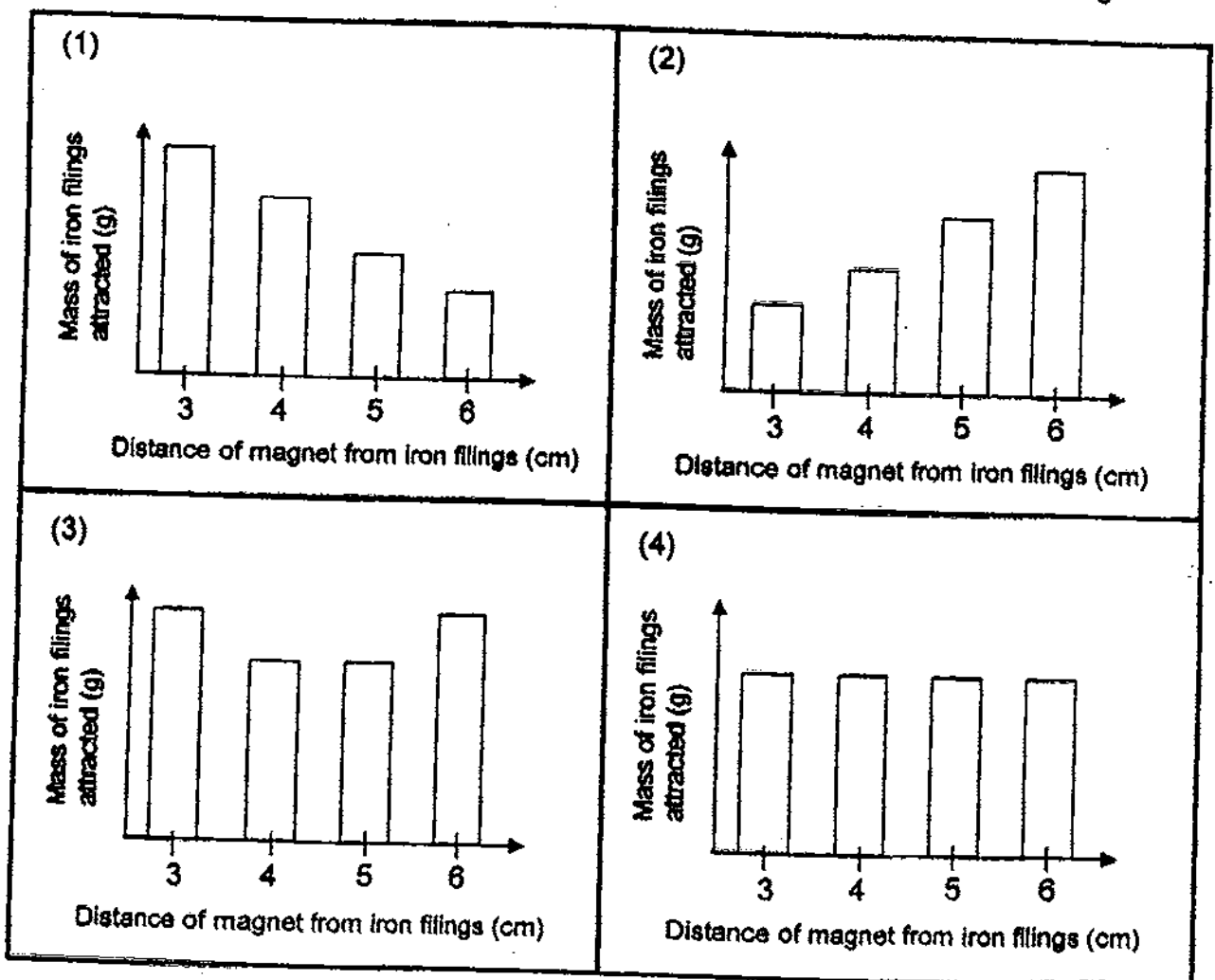

Name : _____ Index No : _____ Class : P5 _____

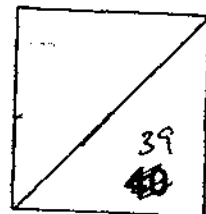

SECTION B (40 marks)

For questions 26 to 39, write your answers clearly in the spaces provided.

The number of marks available is shown in the brackets [] at the end of each question or part question.

26. The diagram below shows the growth of a germinating seed at different stages (NOT in order): W, X, Y and Z.

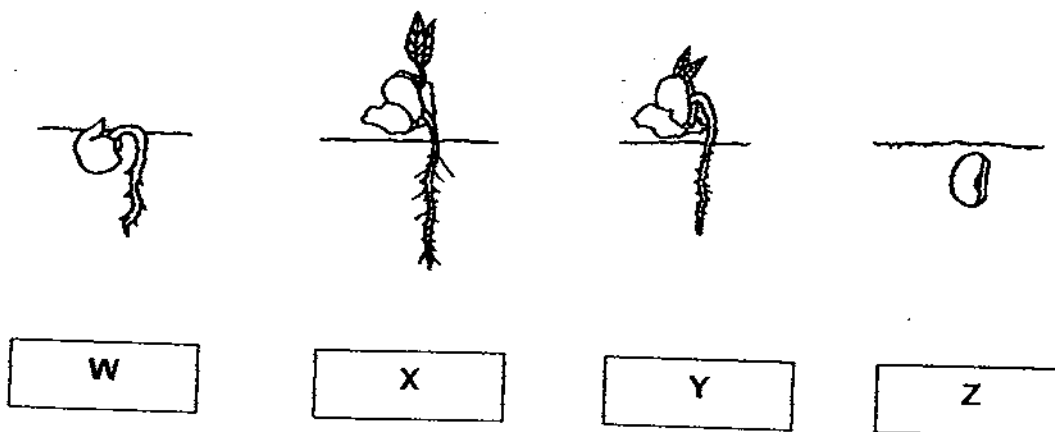

- (a) Arrange the development of the germinating seed in the correct order in the diagram below.

[1]

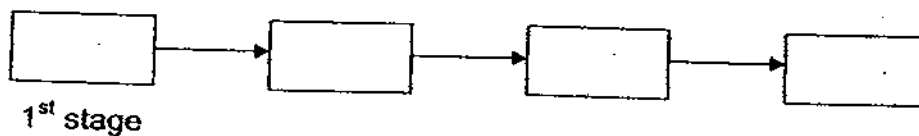

- (b) Which part of the seedling develops first?

[1]

27. The flow chart below identifies some cells: W, X, Y and Z.

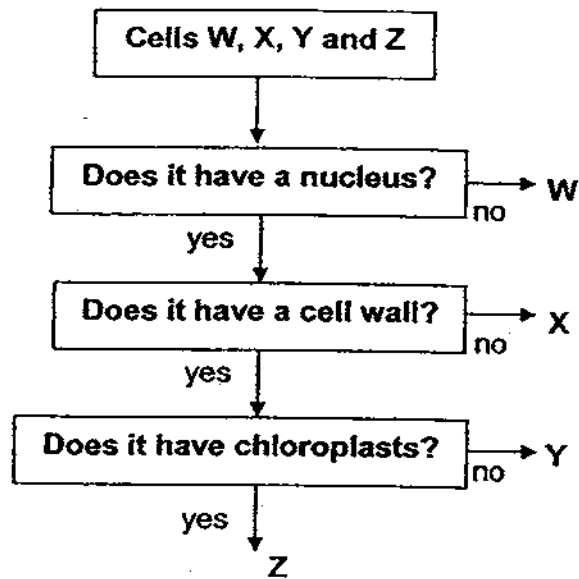

Based on the information above, answer the following questions:

- (a) Which one of these cells, W, X, Y or Z, cannot reproduce? [½]
-
- (b) Explain why Cell Z is most likely able to carry out photosynthesis. [1½]
-
-
- (c) Which of these cells, X, Y and/or Z, is/are animal cell(s)?
Give a reason for your answer. [1]
-
-

28. Peter put an equal number of seeds in each of these pots: P, Q, R, S, T and U. He placed the pots of seeds at the balcony of his apartment. However, he watered each pot daily with a different amount of water as shown in the table below.

pots	P	Q	R	S	T	U
amount of water (mℓ)	10	20	30	40	50	60

After a week, Peter recorded the average height of the seedlings in the chart below.

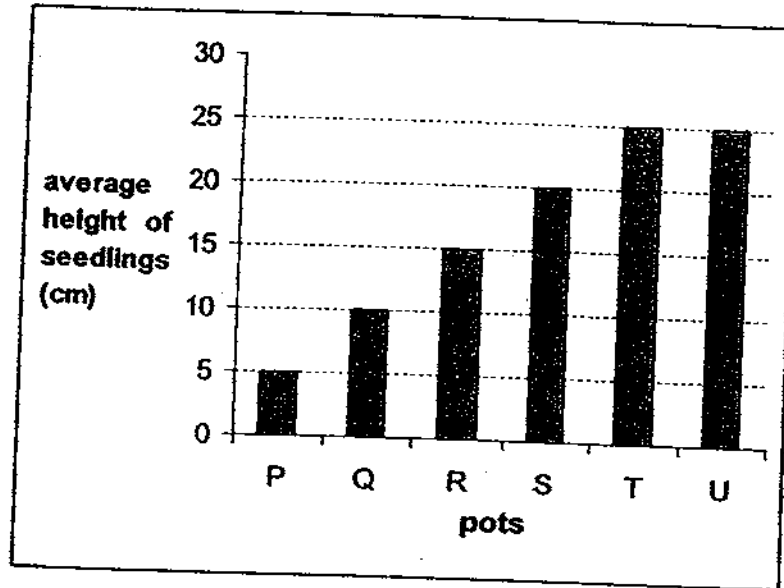

Based on the information above, put a tick (✓) in the appropriate boxes below to indicate whether each of the following statement is *true*, *false* or *not possible to tell*. [3]

	true	false	not possible to tell
(a) The average height of the seedlings in pot Q was 10 cm.			
(b) As the amount of water given increased, the average height of the seedlings increased.			
(c) Peter predicted that when 47.5 ml of water was given to a pot of seeds, the average height of the seedlings would be as tall as those seedlings in pots T and U.			

29. When Alyssa visited her grandmother, who lives on an island off Singapore, she discovered 2 types of plants, X and Y, growing on it as shown in Diagram 1 below.

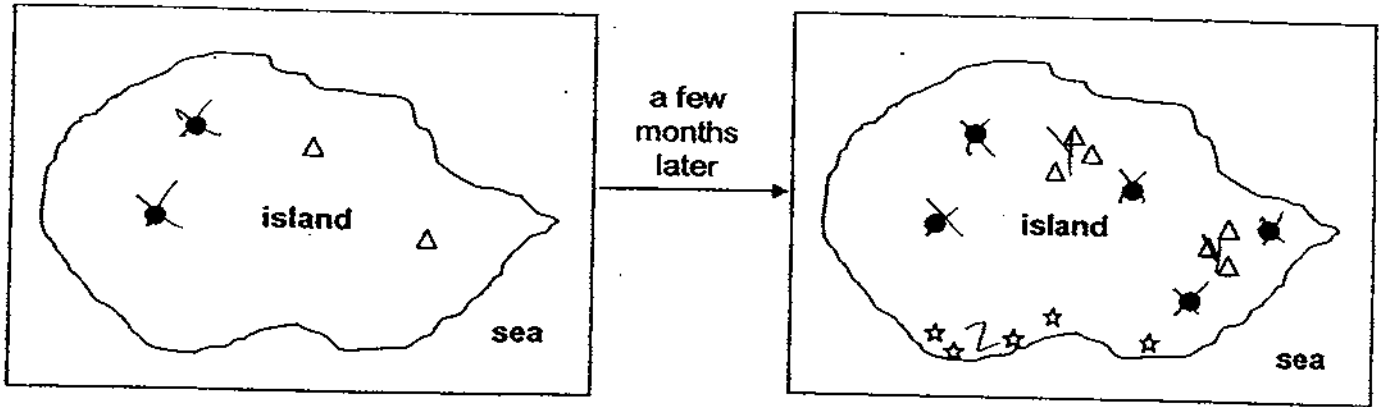

Diagram 1

Diagram 2

Key	
plant X	●
plant Y	△
plant Z	☆

A few months later, when Alyssa visited her grandmother again, she noticed that there were more of such plants, X and Y, on the island. **ANOTHER** new plant, Z, was also found growing on the island as shown in Diagram 2.

Based on the information on page 25, answer the following questions:

- (a) State the method of dispersal of the fruit / seed of each of the following plants: [1]

X	
Y	
Z	

- (b) Name one physical characteristic of the fruit / seed of plant Z that helps in its dispersal. [1]

- (c) Give a reason why plants need to reproduce. [1]

30. The diagrams below show two leaves, A and B.

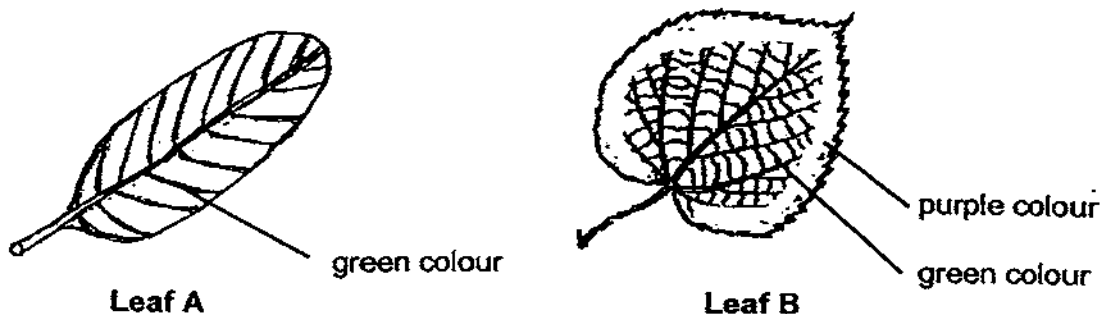

Leaf A was plucked from a healthy plant that had been left in a wooden cupboard for two days.

Leaf B was plucked from a healthy plant which had been in the sun for two days.

Immediately, the colours of these leaves were first removed by boiling the leaves and soaking them in alcohol, then they were tested for the presence of starch using iodine. Iodine, a yellow-coloured solution, turns dark blue when it comes into contact with starch.

Note: Excess food produced by leaves (glucose/ sugar) that is NOT used is converted to starch.

(a) Name the part in a leaf cell which enables it to make food. [1]

(b) When a few drops of iodine were added to Leaf A, the iodine remained yellow.

Explain this observation. [1]

(c) When a few drops of iodine were added to the green and the purple parts of Leaf B, the iodine turned dark blue.

What could be inferred from this observation? [1]

31. The diagram below shows how blood flows from one part of the body to another in an organism.

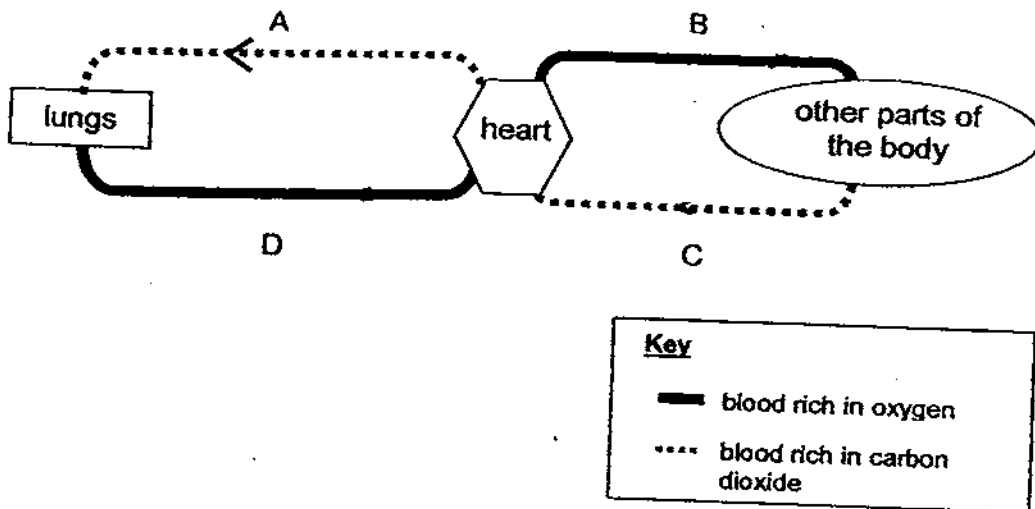

- (a) The amount of oxygen in the blood at C was lower than that at D.

DRAW arrowheads (\rightarrow) along the paths of B, C and D in the diagram above. (Arrowhead on A has been done as an example.)

[1]

- (b) Explain why the amount of oxygen in the blood at C was lower than that at D.

[2]

32. The diagrams below show the respiratory systems of 2 organisms.

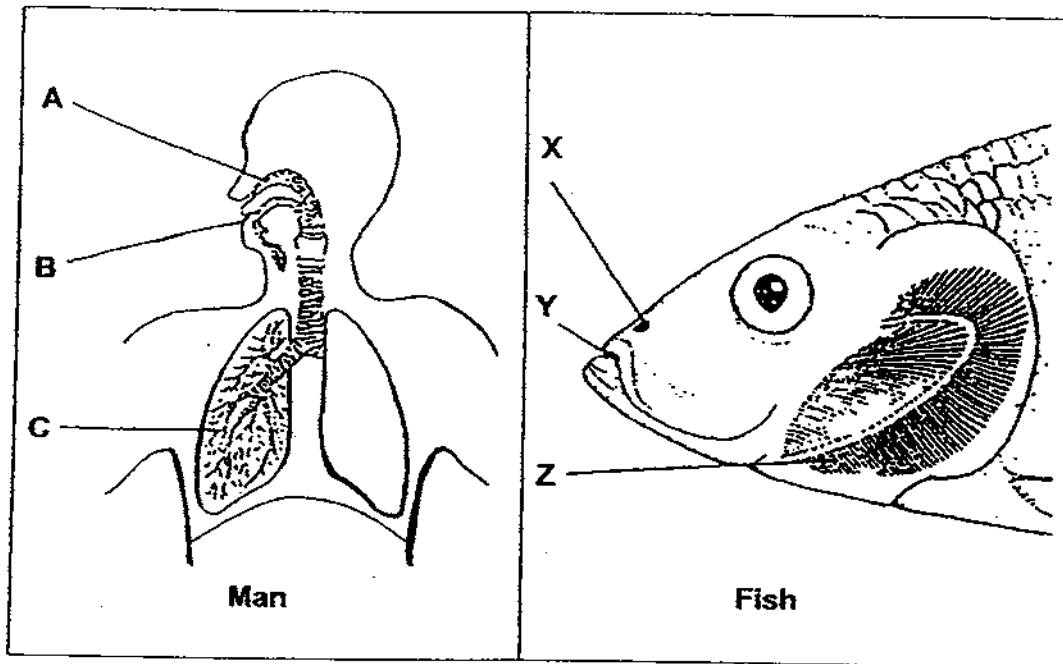

Parts A, B and C and Parts X, Y and Z work together to enable respiration to take place in Man and Fish respectively.

(a) State the part in which the exchange of gases takes place in each of the following organisms: [2]

(i) Man (A, B or C): _____

(ii) Fish (X, Y or Z): _____

(b) Explain how gaseous exchange takes place in the Fish. [2]

33. Mark had two identical air-tight jars, A and B. Each of these jars had an equal amount of water. A different organism was placed in Jars A and B.

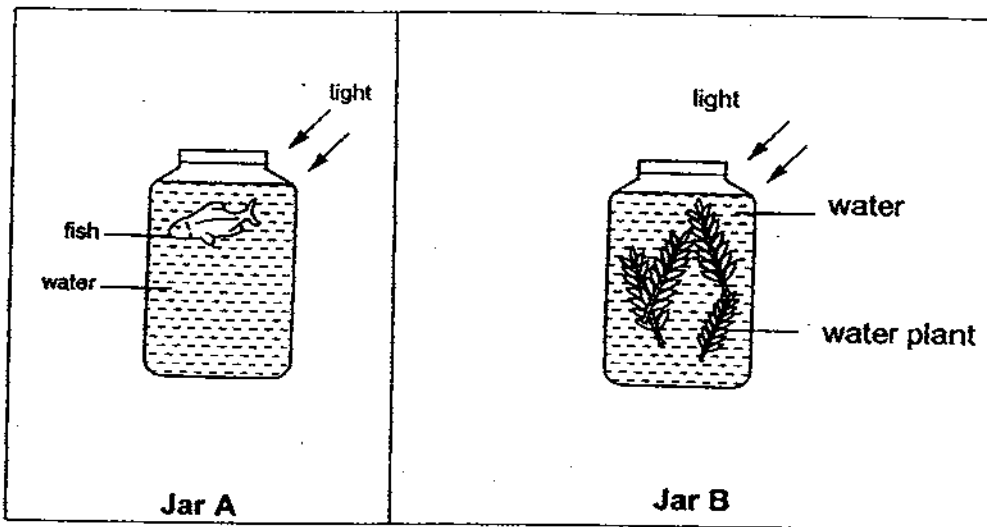

Mark wanted to find out the change in the concentration of dissolved carbon dioxide in the water of each jar during the period, 7 am to noon.

- (a) Indicate with a tick (\checkmark) in the table below, the change in the amount of carbon dioxide in each of these jars. [1]

Jar	increase	decrease
A		
B		

- (b) Explain your answers in each of the following cases: [2]

Jar A	
Jar B	

34. Sarah placed a plant in a jar of red-coloured water as shown below.

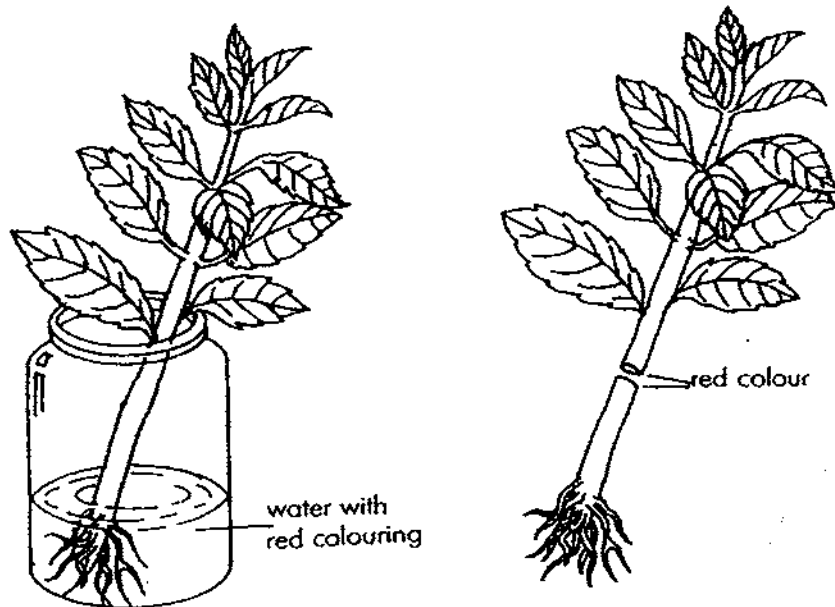

After the plant was left aside for a day, Sarah observed that some parts of its leaves and a short length of its stem that was cut had turned red.

From her observations, Sarah made the following conclusion about the transport system in plants:

WATER TRAVELS UP THE STEM OF A PLANT.

Her teacher asked her to complete the table below for each of the following questions: [2]

		Explanation
(a)	How did water travel up the plant to its leaves?	
(b)	Why was this necessary for the survival of the plant?	

35. Ken had 3 identical beakers, X, Y and Z. Each beaker contained water of a different temperature as shown in the experimental set-ups below.

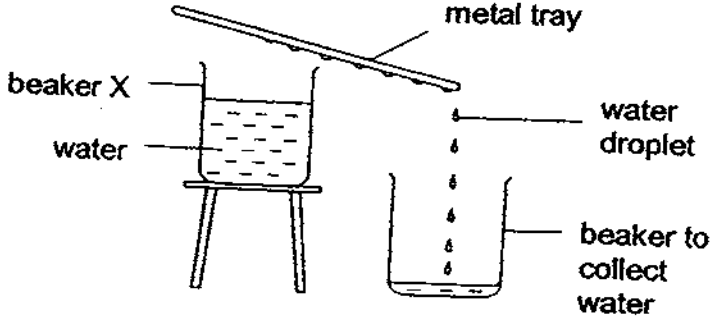
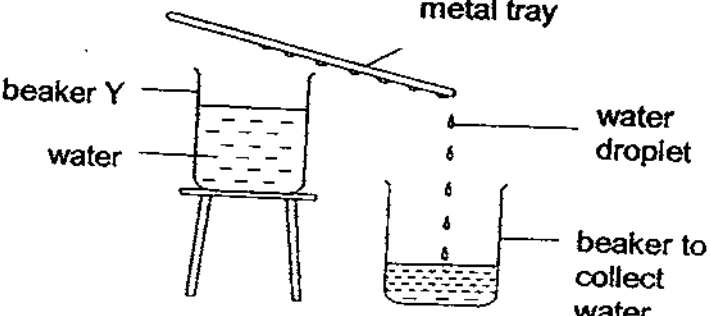
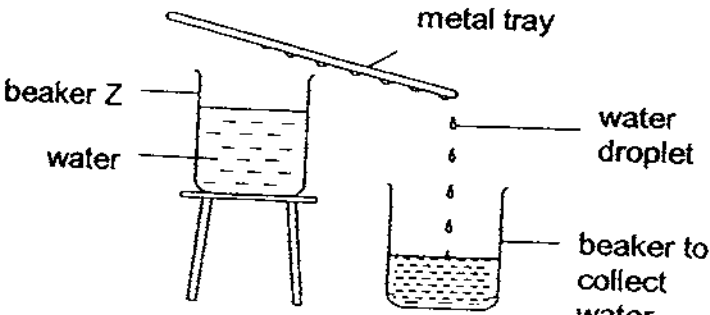
experimental set-up	temperature of water (°C)	amount of water collected (mℓ)
	70	8
	80	16
	100	28

(a) What was the aim of Ken's experiment?

[1]

(b) Explain how the tiny water droplets were formed on the undersides of the metal trays.

[2]

36. Margaret set up an experiment to find out which material, styrofoam, metal or glass, is a better conductor of heat. She poured water of 20°C into cups of the same size. Each of these cups was placed into a plastic basin. Each plastic basin was filled with the same amount of water at 100°C . Margaret then used a thermometer to measure the temperature of the water in each cup.

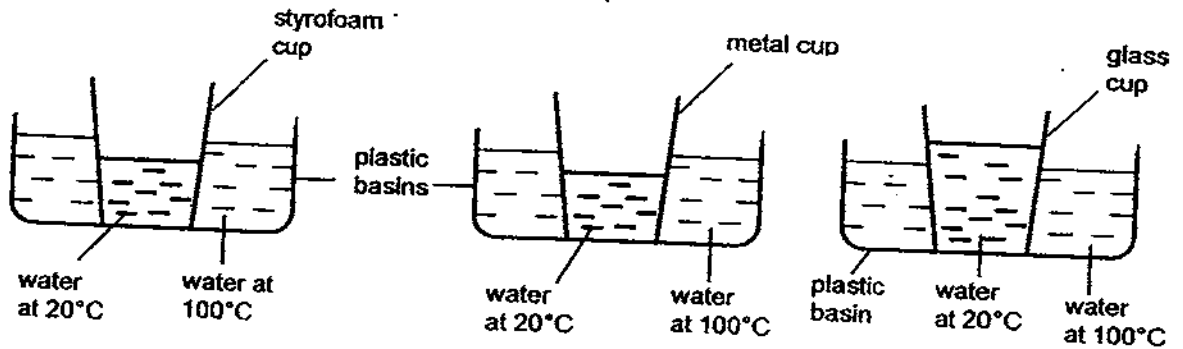

Margaret's classmate commented that her experiment was unfair.

- (a) What should Margaret do to ensure a fair test? [1]

The graph below shows the temperature of the water in the metal cup and the temperature of the water in the basin where the cup was placed in.

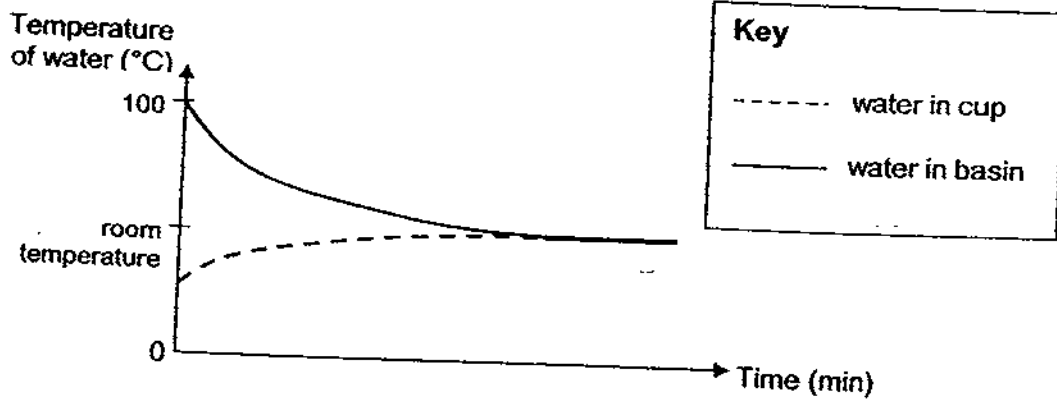

- (b) Explain how the temperature of the water in the basin eventually reached room temperature. [2]

37. Harry had a circuit tester as shown below.

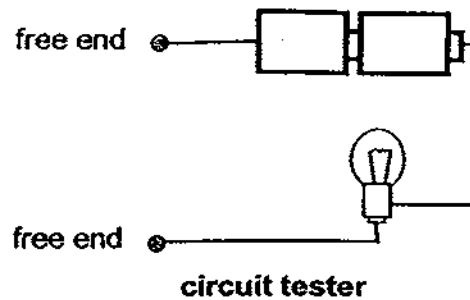

Harry had a circuit card with four metal paper clips: A, B, C, and D, which were connected on the underside by wires. Using the circuit tester, Harry connected each of these clips to one free end of the circuit tester. He recorded the results shown in the table below.

paper clips attached to free ends	Does the bulb light up?
A and B	no
A and C	yes
A and D	yes
B and C	no
B and D	no
C and D	yes

- (a) Based on Harry's results, **DRAW** the wires in the circuit card below to show how the paper clips were connected. [1]

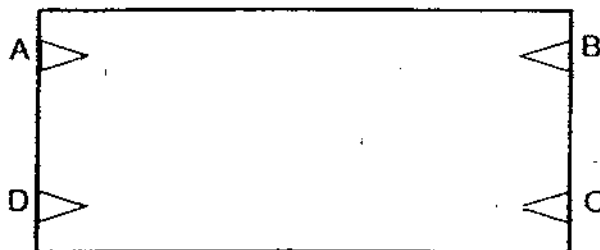





One of the wires in the circuit card snapped. Harry connected the paper clips on the circuit card to the free ends of the circuit tester again.

His observations are shown below.

paper clips attached to free ends	Does the bulb light up?
A and B	no
A and C	yes
A and D	yes
B and C	no
B and D	no
C and D	no

- (b) **MARK** an X on the wire drawn on the circuit card in (a) to show which of the wires snapped. [1]

Harry attempted to replace the broken wire with 4 other types of wires of different thickness but of the same length and material.

thickness of wire			
P	Q	R	S
			

Harry discovered that the thickness of the wire affected the brightness of the bulb in the circuit tester. He recorded his observation in the bar graph below. (Lux is the unit for measuring the brightness of the bulb.)

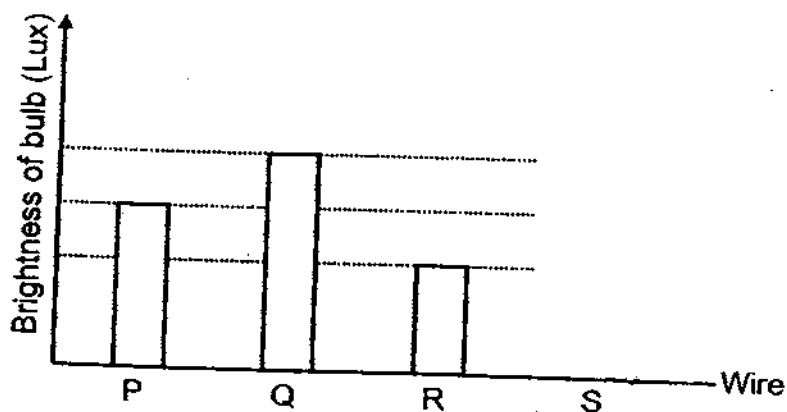

- (c) Complete the bar graph above. **DRAW** a bar to represent the brightness of the bulb when wire S was used. [1]

38. Andrew set up an experiment as shown below using identical wires, batteries, plastic trays, bulbs and iron plates.

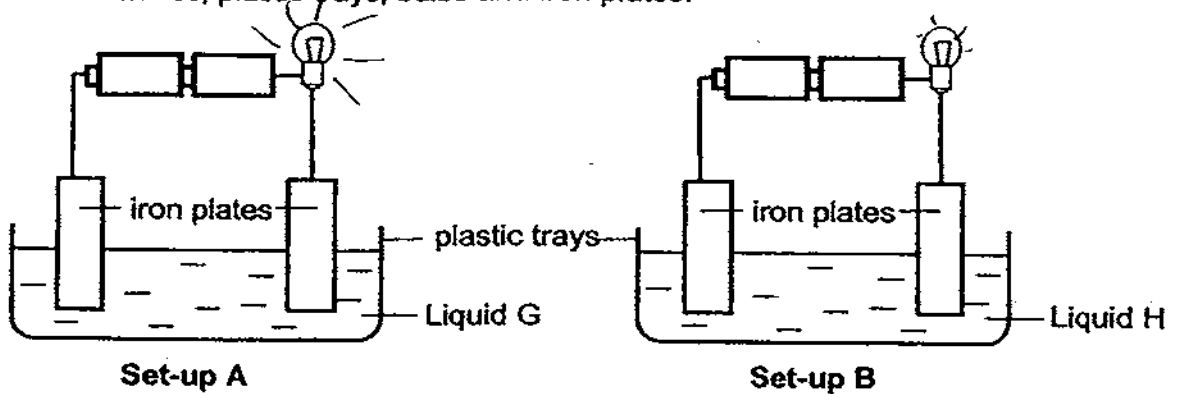

Based on the information above, answer the following questions:

- (a) What could be the aim of Andrew's experiment? [1]

Andrew observed that the bulb in Set-up A lit up more brightly than the bulb in Set-up B.

- (b) What could Andrew conclude from his experiment? [1]

Andrew removed Liquid G from Set-up A as shown in the diagram below.

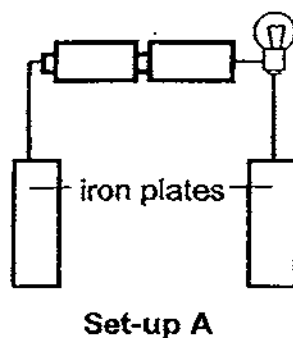

- (c) He observed that the bulb did **NOT** light up. Explain why. [1]

39. Su Mei attached two pieces of magnet to a wheel as shown below.

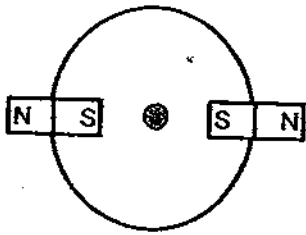

top view of the wheel

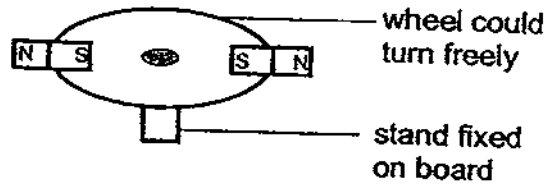

side view of the wheel

She placed the wheel on a board with an electromagnet set-up. In this electromagnet set-up, all objects were fixed in their positions as shown below. However, the iron bar that was attached to an elastic spring could move from its original position.

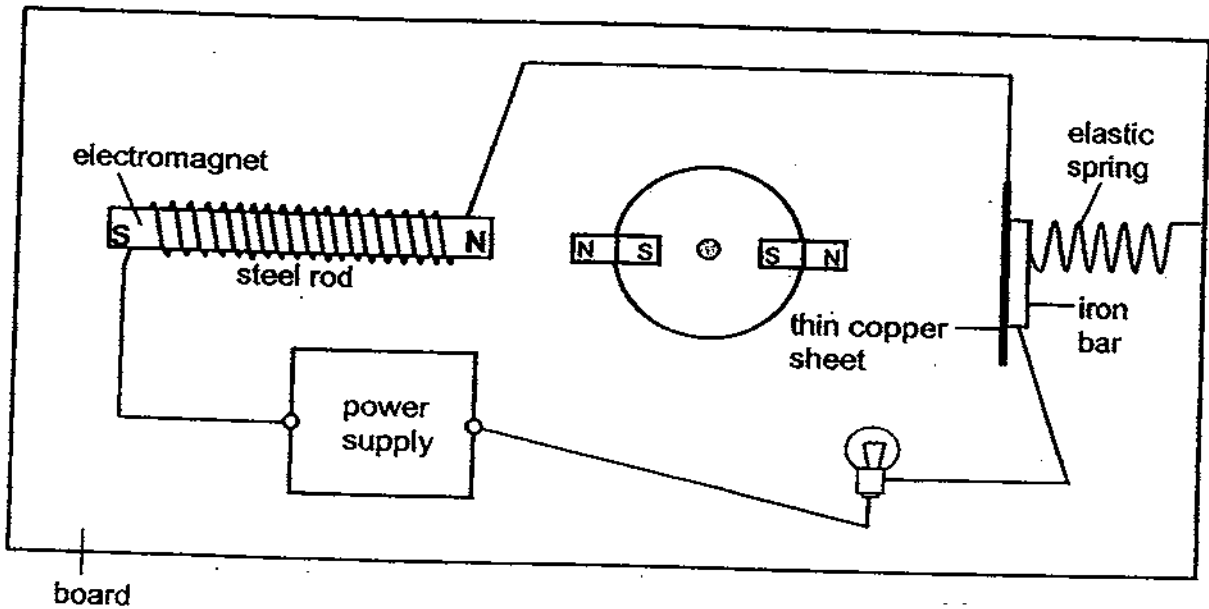
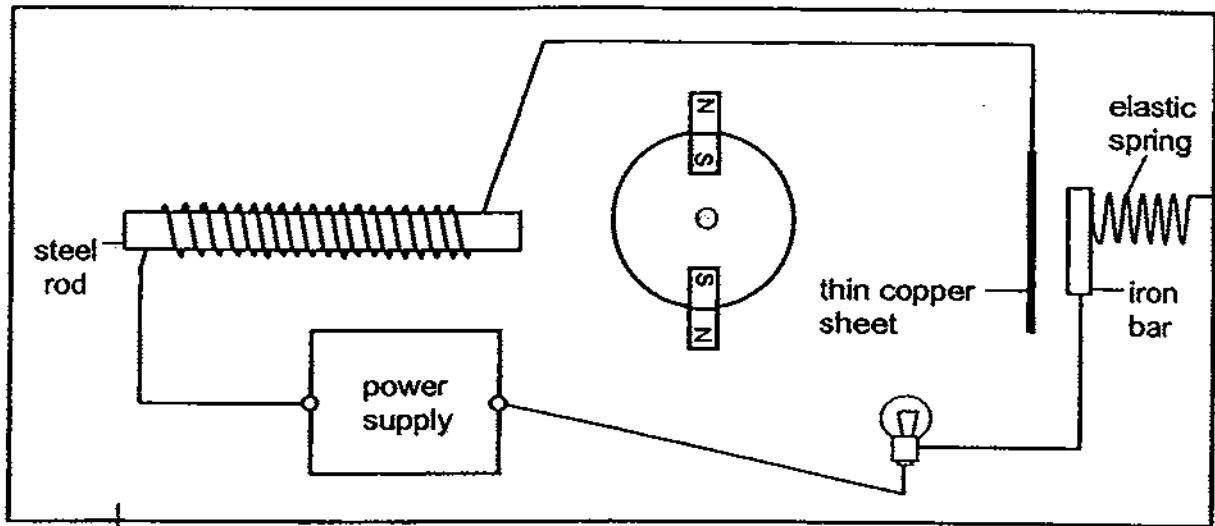

Diagram 1

When the wheel was placed in the set-up, the magnet on the wheel attracted the iron bar, closed the circuit and caused the bulb to light up. The steel rod became magnetised and the poles of the electromagnet were as shown in Diagram 1.

When the wheel spun to the position as shown in **Diagram 2**, the circuit was opened and the bulb did **NOT** light up.



board

Diagram 2

- (a) Su Mei observed that the wheel spun in a clockwise direction after the circuit was closed (as shown in **Diagram 1** to **Diagram 2**).

What caused the wheel to move?

[1]

- (b) Su Mei also observed that the wheel spun continuously by itself.

What could Su Mei observe of the bulb?

[1]

-END OF PAPER-

Setters: ~~Mr. P. S. G. ...~~



ANSWER SHEET

EXAM PAPER 2009

SCHOOL : RAFFLES GIRLS' PRIMARY
SUBJECT : PRIMARY 5 SCIENCE

TERM : SA2

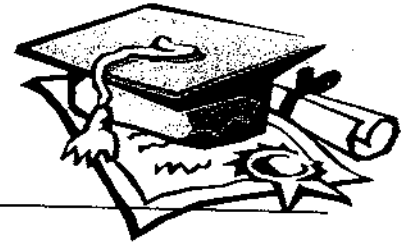

Q1	Q2	Q3	Q4	Q5	Q6	Q7	Q8	Q9	Q10	Q11	Q12	Q13	Q14	Q15	Q16	Q17
1	3	1	2	3	2	2	3	3	4	2	2	4	2	4	3	1

Q18	Q19	Q20	Q21	Q22	Q23	Q24	Q25
1	1	4	3	1	1	4	1

26)a) Z → W → Y → X b) The roots.

27)a) W.

b) It is because only leaf cells have chloroplast, thus we can conclude that cell Z is from a leaf, hence it can use the chlorophyll contained in the chloroplast to photosynthesize by trapping light energy.

c) X. It is because unlike plant cells, animal cells do not have a cell wall, as cell X does have a cell wall, we can conclude that cell X is an animal cell.

28)a) T b) F c) Not

29)a) X: wind Y: splitting Z: water

b) It has a fibrous husk to allow the seed to be dispersed.

c) It is to allow the continuity and survival of their own kind.

30)a) Chloroplast.

b) Leaf A does not contain starch, starch was used up as it was not able to make food in the absence of light.

We can infer that plants need light to be able to photosynthesize. Leaf B contains starch as it was able to make food in the presence of light.

31)a)

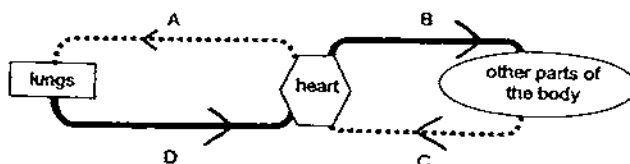

31)b)When the heart pumped blood rich in oxygen to the other party of the body, the other party of the body are respiring, thus they took in the oxygen and produced carbon-dioxide, hence the blood at C was lower than B. However, the blood at D is rich in oxygen as the lungs took in oxygen and replenished the blood at D to be transported to the heart and other parts of the body.

32)a)i)C. ii)Z.

b)Water containing dissolved oxygen enters through the mouth and washes over the gill filaments. Dissolved oxygen moves from the water into the blood vessels to all parts of the fish carbon dioxide produced as a waste product of life processes is transported by the blood to the gills and back to the water again. Carbon dioxide is removed from the fish as water flows out from under the gill covers when they open.

33)a)A: increase B: decrease

b)A: It is because the fish in Jar A is respiring, thus it took in oxygen and produced carbon-dioxide, hence there will be a lesser supply of oxygen, while there will be more carbon-dioxide.

B: It is because there is light passing through Jar B, thus it will allow the water plant to take carbon-dioxide and produce oxygen during photosynthesis, hence there will be less carbon-dioxide than oxygen.

34)a)The water taken in by the roots are transported in xylem tubes to all parts of the plant.

b)It is essential for the other party of the plant to receive water to carry out life processes and photosynthesis.

35)a)To find out if the temperature of the water affects the rate of evaporations.

b)When the water in the beaker is heated, it will evaporate into water vapour, the water vapour will then rise and condense on the cool surface of the undersides of the metal tray, it will then form into tiny water droplets.

36)a)Margaret should make sure the amount of water in each cup is the same to ensure a fair test.

b)The water in the basin will lose heat to the cup and surrounding air till it reached the room temperature and to the water in the cup.

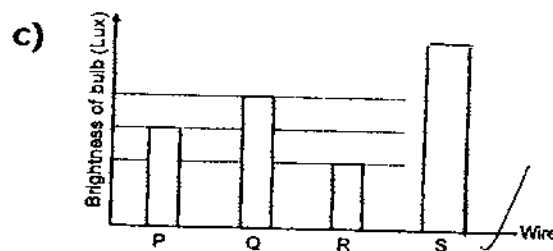
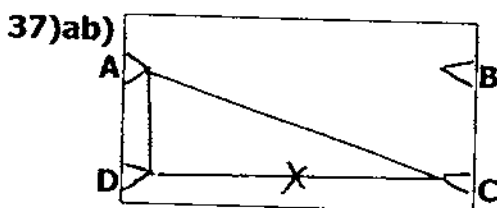

38)a)The aim of the experiment is to find out which liquid, G or H is a better conductor of electricity.

b)Andrew can conclude that liquid G is a better conductor of electricity than liquid H.

c)It is because there is a gap in between the two iron plates, thus the circuit is open, not allowing electricity to flow through, thus the bulb did not light up.

39)a)After the circuit is closed, the steel rod becomes an electromagnet, with its North pole facing the North pole of the magnet, repel each other, the magnet would turn its north pole away from the steel rod, thus causes the wheel to move.

b)The bulb will go on and off continuously.