

# METHODIST GIRLS' SCHOOL

Founded in 1887



## PRIMARY 5 END-OF-YEAR EXAMINATION 2010 SCIENCE

### BOOKLET A

Total Time : 1 hour 45 minutes

#### INSTRUCTIONS TO CANDIDATES

Do not open the booklet until you are told to do so.  
Follow all instructions carefully.  
Answer all questions.

Name: \_\_\_\_\_ ( )

Class: Primary 5. \_\_\_\_\_

Date: 11 October 2010

This booklet consists of 16 printed pages excluding cover page.

**Section A (30 × 2 = 60 marks)**

For each question from 1 to 30, four options are given. One of them is the correct answer. Make your choice (1, 2, 3 or 4). Shade the correct oval (1, 2, 3 or 4) on the Optical Answer Sheet provided.

1. Look at the diagram below.

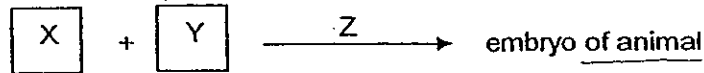

What do the letters X, Y and Z represent?

	X	Y	Z
(1)	pollen grain	ovule	pollination
(2)	ovule	sperm	reproduction
(3)	sperm	egg	fertilization
(4)	sperm	pollen grain	binary fission

2. Which one of the following statements explains why some animals lay a large number of eggs?

- (1) To increase the chance of producing better eggs.
- (2) To produce excess eggs as food for other animals.
- (3) To increase the chance of survival of their species.
- (4) To compete with other animals in producing more eggs.

3. Which of the following statements is correct about cells in living organisms?

- (1) They are the basic unit of life for animals only.
- (2) A unicellular organism needs a nuclear material to survive.
- (3) A multicellular organism has only one cell in its body.
- (4) Plant cells and animal cells differ in terms of shape only.

4. Some organs in the human body are shown below.

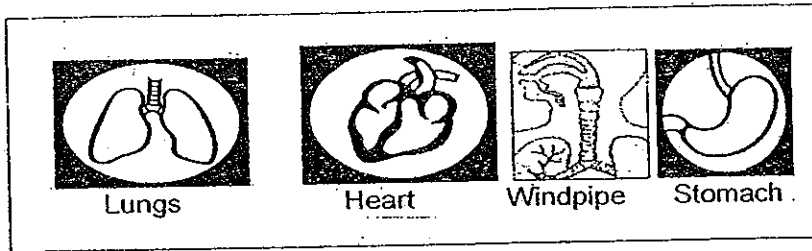

Which one of the following organs in the human body has the similar function as the stomata in plants?

- (1) Lungs
- (2) Heart
- (3) Windpipe
- (4) Stomach

5. Study the diagram carefully.

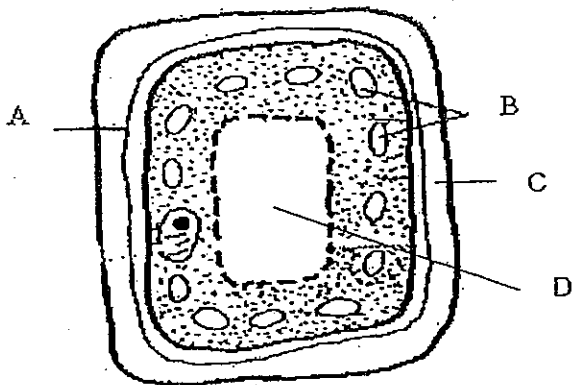

Which of the following statements about the diagram is/are true?

- A: The diagram shows a plant cell.
- B: Part B enables the cell to make food.
- C: Part C controls all the activities of the cell.
- D: Part D supports and gives the cell its shape.

- (1) A only
- (2) A and B only
- (3) A, B and D only
- (4) A, B, C and D

6. The diagram below shows the family tree of Kenneth.

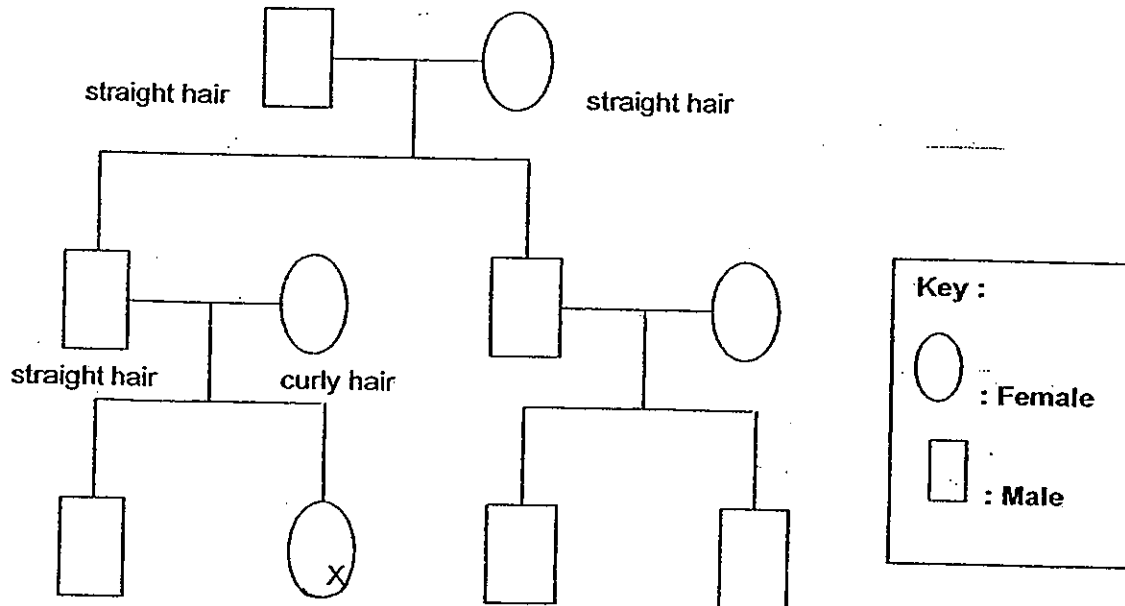

Kenneth

Based on the family tree, which of the following statements are true?

- A: X is Kenneth's sister.
- B: Kenneth inherited his straight hair from his mother.
- C: Kenneth's grandparents have two daughters and two sons.
- D: The grandparents shown in the family tree are the parents of Kenneth's father.

- (1) B only
- (2) A and D only
- (3) A, B and D only
- (4) A, B, C and D

7. The table below describes the differences in sexual reproduction between plants and humans.

	Humans	Plants
Male sex cell	Sperm	X
Female sex cell	Egg	Y
Formed after fertilisation	Baby	Z

Which of the following correctly identifies X, Y and Z?

	X	Y	Z
1	Anther	Stigma	Seed
2	Sperm	Ovary	Fruit
3	Filament	Style	Seed
4	Pollen Grain	Egg	Fruit

8. Lynn carried out a test to show that plants grow better in soil with fertilizer. She placed two potted balsam plants, side by side, in a garden and added a spoonful of fertilizer to the soil in one of the pots. Every day, she gave each pot of plant 500 ml of water. Lynn thought that she had conducted a fair test but her brother disagreed.

Which one of the following variables must be kept constant?

- (1) Amount of soil used in each pot
  - (2) Amount of air each plant received
  - (3) Amount of sunlight each plant received
  - (4) Amount of water added to each pot of plant
9. Anne looked at some plant cells under a microscope. She noticed some cells with thick walls. The cell will most probably \_\_\_\_\_.
- (1) support and strengthen the plant
  - (2) absorb water and mineral salts for the plant
  - (3) transport foods substances to other parts of the plant
  - (4) controls the movement of materials in and out of the cell

10. Why does your heart beat faster when you exercise?

Debby : To pump more blood to all parts of our body.

Lin : To supply more food and oxygen to all parts of our body.

Ella : To get rid of carbon dioxide and water vapour produced by our body.

Who answered correctly?

- (1) Ella and Lin
- (2) Ella and Debby
- (3) Debby and Lin
- (4) Debby, Lin and Ella

11. Study the flow chart below.

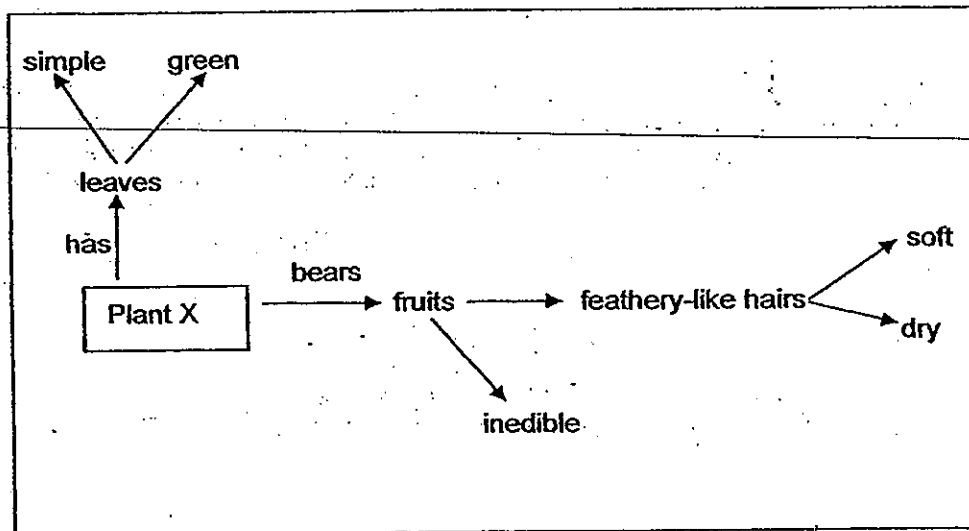

From the information given, the seeds of Plant X are most likely dispersed by

- (1) water
- (2) wind
- (3) animals
- (4) explosive action

12. Several people were trapped in the carriage of an MRT train during peak hours one day. There was no fresh air entering the train. Which of the following shows how the amount of gases in the carriage changed after an hour?

	Carbon dioxide	Oxygen	Water Vapour	Nitrogen
(1)	Decrease	increase	increase	no change
(2)	Decrease	increase	no change	increase
(3)	Increase	decrease	increase	no change
(4)	Increase	decrease	no change	increase

13. The diagram below shows the cross-section of a flower.

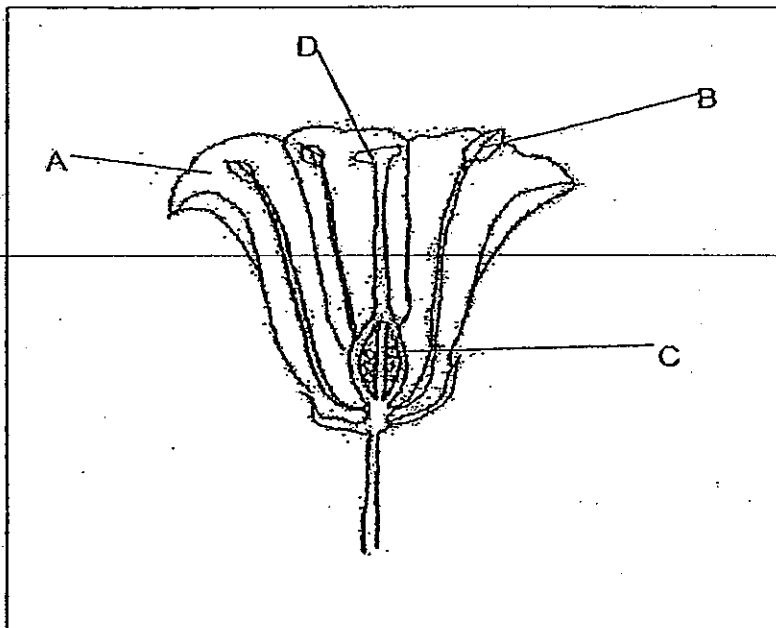

Which one of the following parts A, B, C or D is correctly matched to its function?

	Part	Function
(1)	A	Protects the young developing fruit.
(2)	B	Produces pollen grains.
(3)	C	Develops into the ovules after fertilisation.
(4)	D	Produce sticky substance for fertilisation to take place.

14. Study the flow chart below carefully.

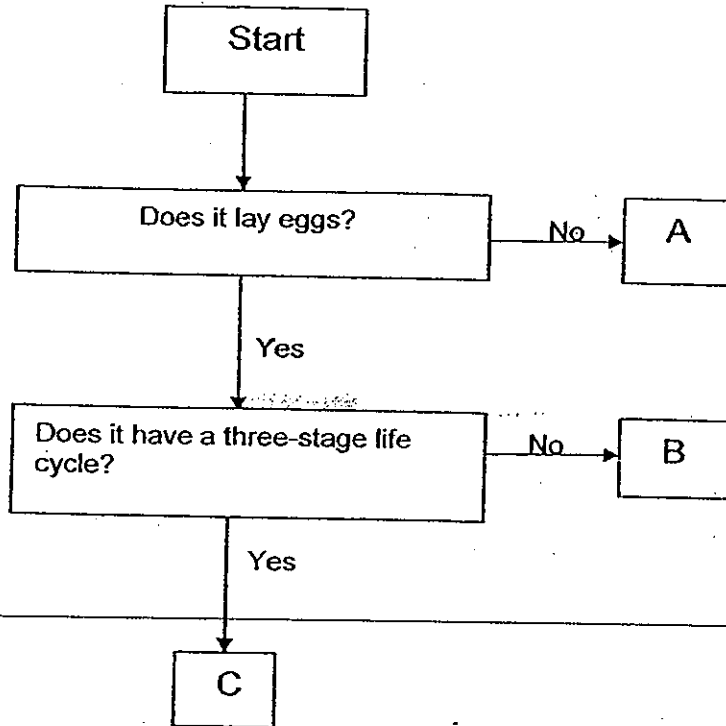

Which of the following represents A, B and C correctly?

	A	B	C
(1)	Chicken	Beetle	Grasshopper
(2)	Platypus	Butterfly	Dragonfly
(3)	Bat	Cockroach	Duck
(4)	Guppy	Mosquito	Chicken



15. The picture below shows several different birds.

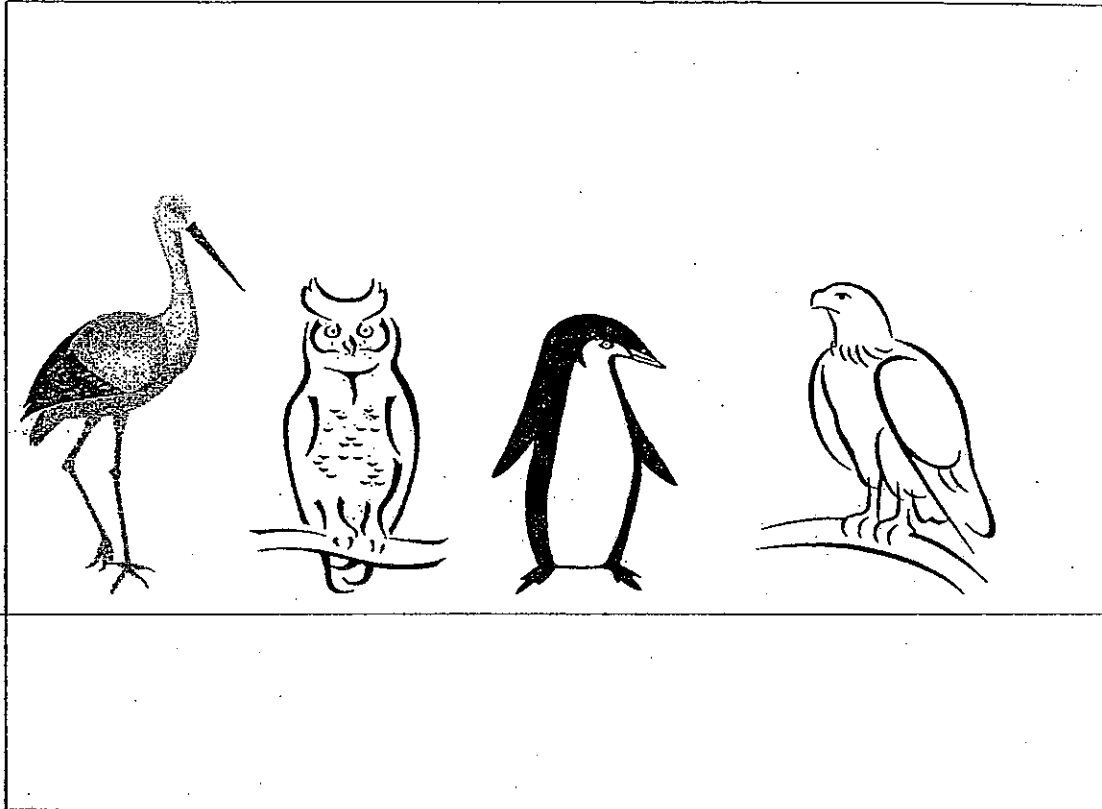

What characteristics do all these birds have?

- A: They are omnivores.
- B: They have feathers.
- C: They have webbed feet.
- D: They have a beak each.

- (1) A and B
- (2) B and D
- (3) A and C
- (4) C and D

16. The table below shows the freezing point of three substances, P, Q and R.

Substance	Freezing Point ( $^{\circ}\text{C}$ )
P	6
Q	31
R	122

Based on the information given above, which one of the following is correct?

- (1) P is a solid at  $4^{\circ}\text{C}$ .
  - (2) P and Q are both liquids at  $29^{\circ}\text{C}$ .
  - (3) Q and R are both gases at  $140^{\circ}\text{C}$ .
  - (4) R can be a liquid or a gas at  $122^{\circ}\text{C}$ .
17. Joe had four magnets as shown below. He labelled them A, B, C and D.

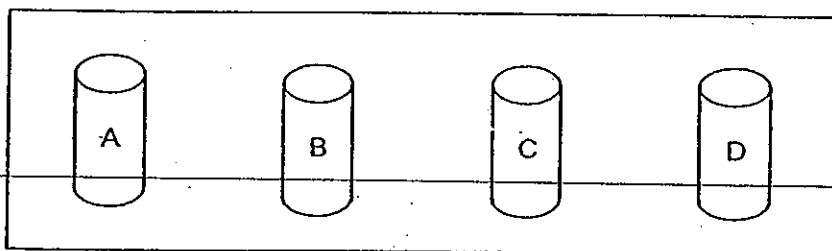

To compare the strength of these four magnets, Joe brought each of the magnets close to some paper clips.

He then tabulated the results in the table below to show the number of paper clips attracted by the magnets, A, B, C and D.

Magnet	Distance between the magnet and the paper clips (cm)	Number of paper clips attracted
A	5	13
B	6	11
C	5	12
D	4	12

Based on the table above, which of the following statements is correct?

- (1) Magnet B is the weakest.
- (2) Magnet A is the strongest.
- (3) Magnet C is as strong as magnet D.
- (4) Magnet D is weaker than magnet C.

18. Maria carried out some experiments on substances X, Y and Z. She recorded the properties of these substances in a table as shown below.

Properties	X	Y	Z
Has definite shape	No	No	Yes
Has definite volume	No	Yes	Yes

Which one of the following is X, Y and Z likely to be?

	X	Y	Z
(1)	Snow	Cloud	Water vapour
(2)	Cloud	Water vapour	Ice
(3)	Mist	Glacier	Snow
(4)	Water vapour	Mist	Glacier

19. Rachel set up the 2 circuits shown below. All the bulbs and batteries used in the circuit are identical.

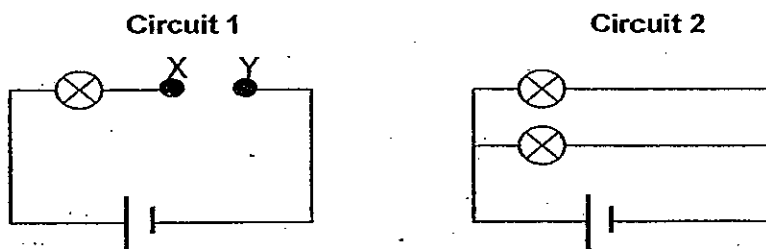

If Rachel adds another bulb at XY in circuit 1, which of the following observations would she make?

- A: The bulbs in Circuit 1 would be dimmer than before.
- B: The bulbs in Circuit 2 would be brighter than those in Circuit 1.
- C: The bulbs in Circuit 1 would light up longer than those in Circuit 2.

- (1) A only
- (2) A and B only
- (3) A and C only
- (4) A, B and C

20. The diagram below shows the three states of water. A, B, C and D represent four different processes.

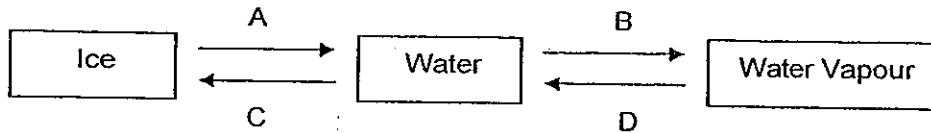

Which one of the following correctly shows that heat is gained or heat is lost in A, B, C and D?

	A	B	C	D
(1)	Heat gained	Heat gained	Heat lost	Heat Lost
(2)	Heat lost	Heat lost	Heat gained	Heat gained
(3)	Heat gained	Heat lost	Heat gained	Heat lost
(4)	Heat lost	Heat gained	Heat lost	Heat gained

21. Zhi Jie is an athlete participating in the YOG. Under the hot sun, he perspires a lot when he runs and stretches. He tested Materials A, B, C and D as shown in the table below to find a suitable fabric for his attire.

Which one of the following fabric is the most suitable for him?

	Materials	Area of material tested (m <sup>2</sup> )	Elastic Test Max length at which the material will stretch before tearing (cm)	Porosity Test Amount of air that can pass through the material (cm <sup>2</sup> )
(1)	A	2	45	2
(2)	B	2	80	9
(3)	C	2	51	9
(4)	D	2	80	5

22. Five light bulbs are placed at different positions in the circuit shown below. All the bulbs are in working condition. A, B, C and D are switches.

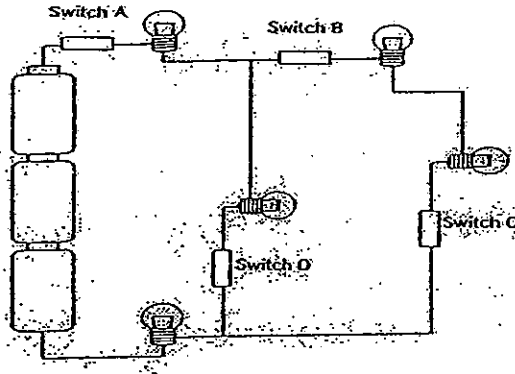

Each of the options below shows the number of light bulbs that would light up accordingly when the switches stated are opened only. Which option is correct?

	4 bulbs light up	3 bulbs light up	No bulb light up
(1)	D	C	B
(2)	C	D	A
(3)	C	B	D
(4)	D	B	A

23. Which one of the following graphs shows the correct relationship between the rate of evaporation and the humidity?

(1)

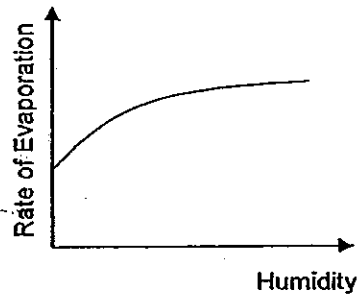

(2)

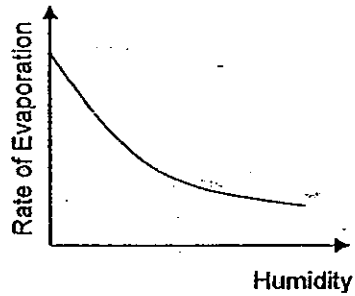

(3)

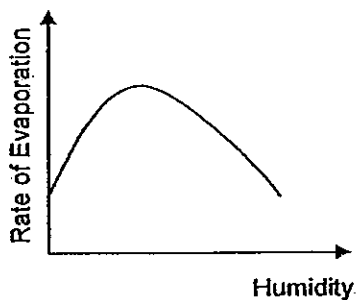

(4)

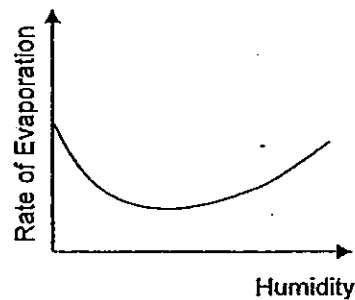

24. Two pieces of unknown substances, W and X, and a magnet are hung from a plastic rod as shown below.

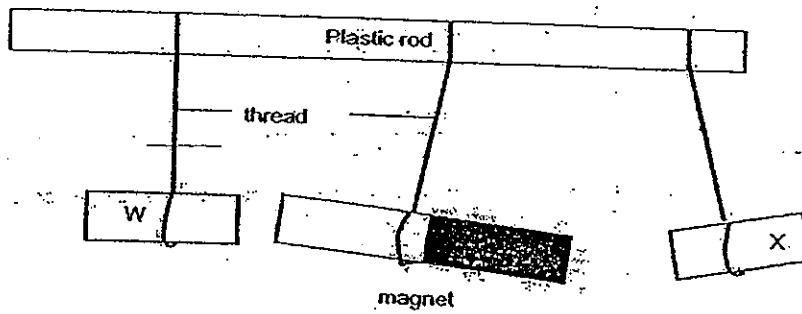

Which one of the following statements is true?

- (1) W and X are magnets.
  - (2) W is made of iron and X is made of copper.
  - (3) W is made of aluminium and X is a magnet.
  - (4) W is a magnetic material but X is a non-magnetic material.
25. Study the classification chart below.

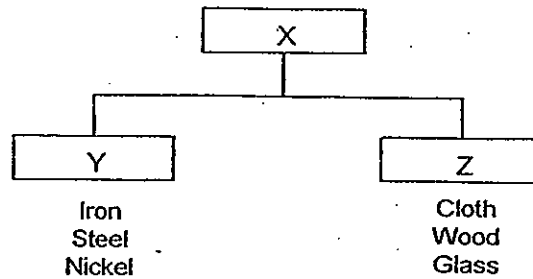

Which of the following headings best describe X, Y and Z?

	X	Y	Z
(1)	Matter	Good conductor of heat	Poor conductor of heat
(2)	Matter	Man made	Natural
(3)	Metals	Conductor of electricity	Insulator of electricity
(4)	Metals	Magnetic	Non-magnetic

26. Ali carried out an experiment in a dark room as shown below. He placed four sheets; A, B, C and D neatly in a straight line. Sheet A has a hole in it.

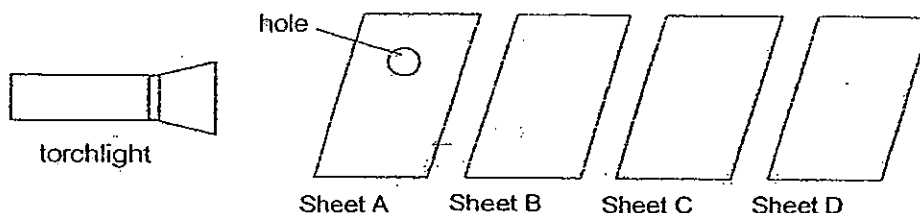

When the torch was switched on, a bright circular patch of light was seen only on sheet C.

Which one of the following shows a possible arrangement of the materials?

	A	B	C	D
(1)	Copper sheet	Tracing paper	Clear plastic	Cardboard
(2)	Cardboard	Clear plastic	Copper sheet	Clear glass
(3)	Clear glass	Cardboard	Tracing paper	Copper sheet
(4)	Tracing paper	Copper sheet	Cardboard	Clear Plastic

27. Study the diagram carefully.



Which of the following statements are correct based on the experiment above?

- A: Heat is lost by the surrounding air to the beaker.
- B: The water droplets came from the water in the beaker.
- C: The temperature of the water is higher at the end of the experiment.
- D: The room temperature is higher than the temperature of the water at the start of the experiment.

- (1) A and B only
- (2) A and C only
- (3) C and D only.
- (4) A, C and D only

28. Study the following circuits below. The batteries and the bulbs used are identical. All the batteries and bulbs used are new and in good working condition.

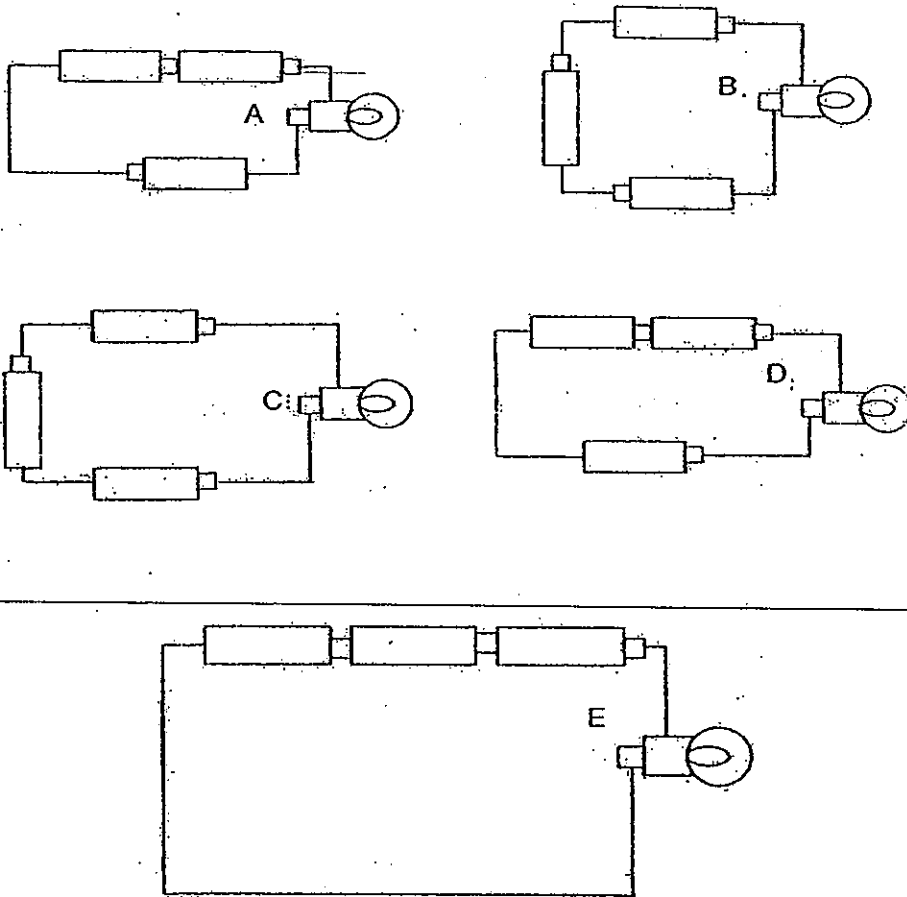

Which of the following bulbs will be of equal brightness?

- (1) A, B and E
- (2) A, C and D
- (3) B, C and D
- (4) C, D and E



29. The diagram below shows 2 bulbs, S and T, connected to a battery.

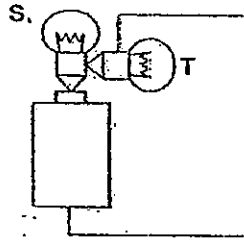

Which one of the following is most likely to occur?

- (1) Only bulb S will light up.  
 (2) Only bulb T will light up.  
 (3) Both bulbs S and T will light up.  
 (4) Both bulbs S and T will not light up.
30. The graph below shows the change in temperature of a liquid in a beaker over a period of 50 minutes.

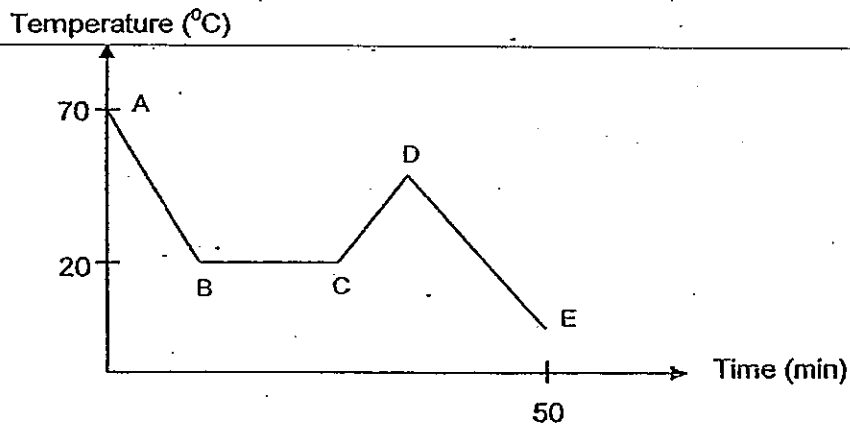

Which of the following(s) is/ are definitely true?

- W: The liquid was freezing at Line BC.  
 X: The boiling point of the liquid is  $80^{\circ}\text{C}$ .  
 Y: Line DE shows a loss of heat energy.  
 Z: A heat source was introduced at point D.

- (1) Y only  
 (2) X and Y only  
 (3) W, X and Y only  
 (4) All of the above

End of Booklet A

# METHODIST GIRLS' SCHOOL

Founded in 1887



## PRIMARY 5 END-OF-YEAR EXAMINATION 2010 SCIENCE BOOKLET B1

Total Time : 1 hour 45 minutes

### INSTRUCTIONS TO CANDIDATES

~~Do not open the booklet until you are told to do so.~~

Follow all instructions carefully.

Answer all questions.

Name: \_\_\_\_\_ ( )

Class: Primary 5 \_\_\_\_\_

Date: 11 October 2010

Booklet A	/ 60
Booklet B1	/ 20
Booklet B2	/ 20
Written Total	/ 100
Practical Test	/ 10
TOTAL	/ 110

This booklet consists of 7 printed pages excluding cover page.

**Section B1: Open-ended Questions (7 questions = 20 marks)**

Read each question carefully and write your answers in the spaces provided.

31 The diagram below shows how our blood travels in our body.

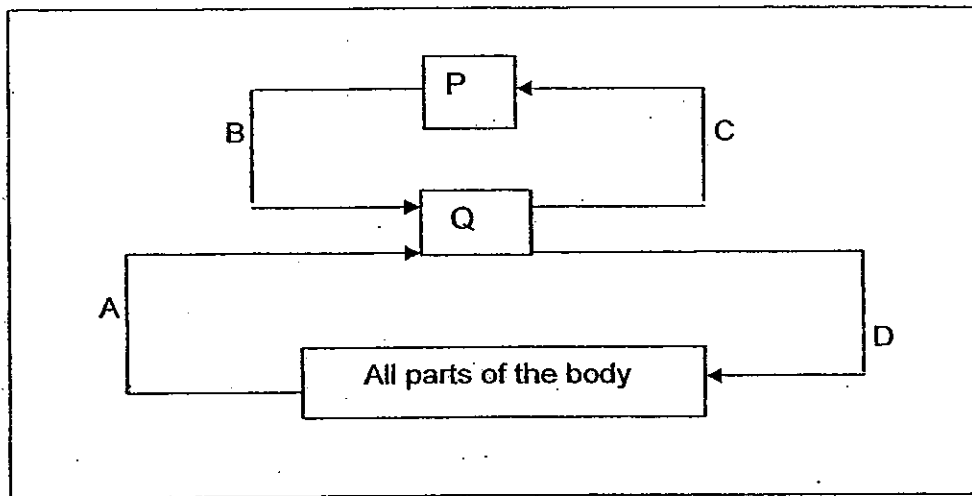

P and Q represent two organs and arrows A, B, C and D represent the movement of blood.

(a) Name the organ P. (1m)

---

(b) Which arrow(s) should represent the movement of blood **rich** in oxygen? (1m)

---

32 Study the flow chart given below.

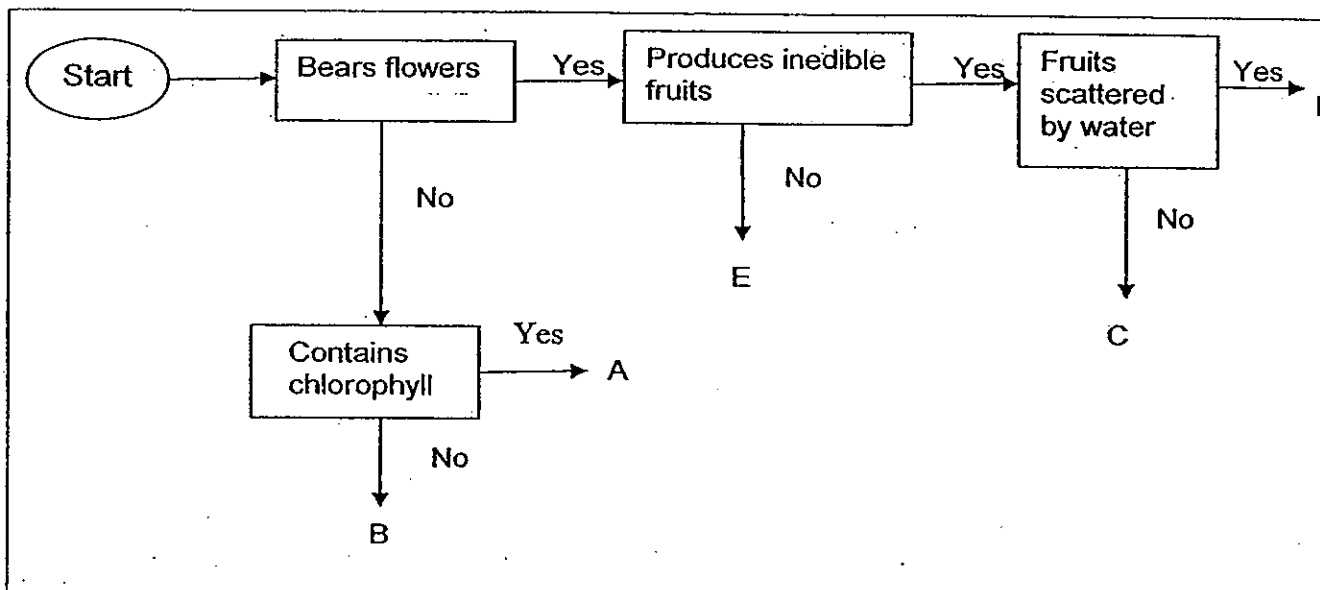

(a) Which letters best represents mushroom and mangrove plant?

Mushroom: \_\_\_\_\_ (½m)

Mangrove Plant: \_\_\_\_\_ (½m)

(b) Name one characteristic of "D" that allows it to be dispersed by the method shown in the flow chart? (1m)

33 Mei Hua drew her family tree, as shown below.

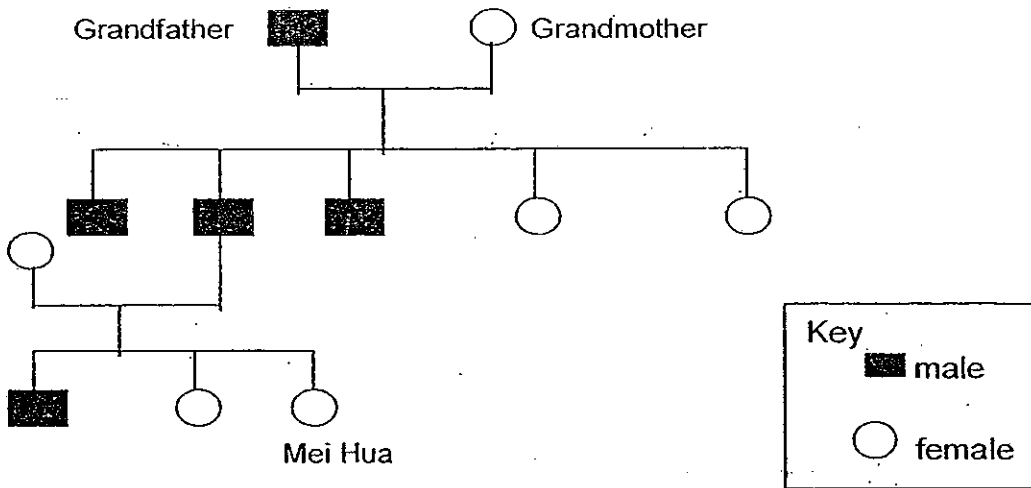

(a) Whose side of her family did Mei Hua draw?

\_\_\_\_\_ (1m)

(b) How many uncles does Mei Hua have?

\_\_\_\_\_ (1m)

(c) How many sisters and brothers does Mei Hua have?

\_\_\_\_\_ (1m)

34 Lionel wanted to find out if the colour of edible fruits affects the dispersal of their seeds by birds. He left the four potted plants whose fruits were of similar size in his garden for 3 days.

Colour of fruits	Original number of fruits	Number of fruits left after 3 days
Black	50	15
Orange	50	6
Green	50	22
Red	50	6

(a) Which coloured fruit/s was/were most popular with birds?

\_\_\_\_\_ (1m)

(b) Name one other variable that Lionel kept constant?

\_\_\_\_\_ (1m)

(c) From the results of the experiment, explain how the colour of fruits affect the seed dispersal by the birds.

\_\_\_\_\_ (1m)

35 The diagram below shows some plant and animal cells.

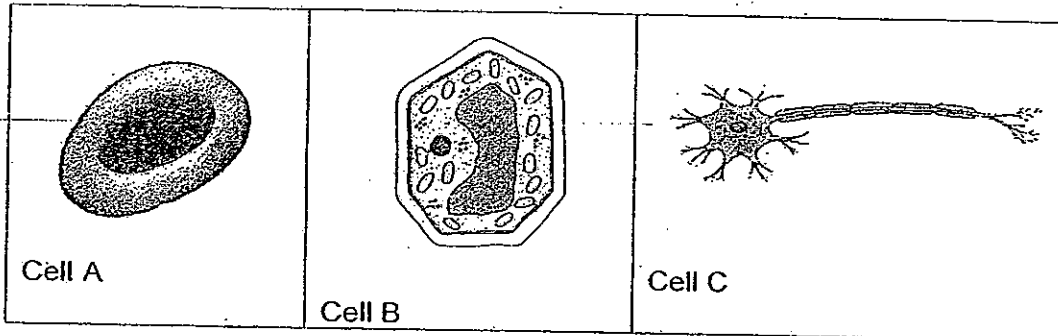

Put a tick (✓) in the correct box for each statement. (1m)

Statement	True	False	Not possible to tell
Cell A and C are <b>plant</b> cells.			
Cell B has a <b>cellulose</b> structure that <b>protects</b> and <b>supports</b> it.			
Cells of <b>similar</b> shape have <b>similar</b> functions.			

Identify Cell A: \_\_\_\_\_ (½m)

Cell C : \_\_\_\_\_ (½m)

State a difference between these 2 cells. (Do not mention shape and size) (1m)

---



---

36 The following pie chart shows the percentage of total area occupied by 3 types of plants. For example, Plant ♠ occupies 20% of the total area.

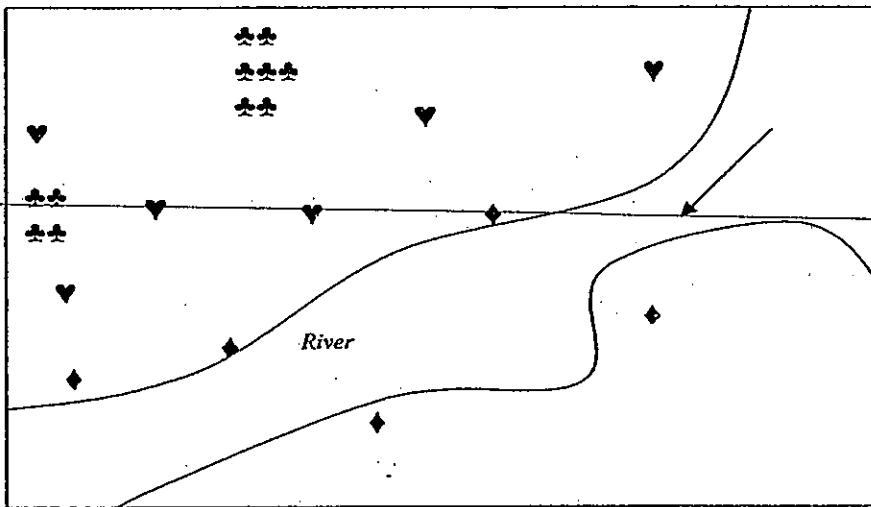
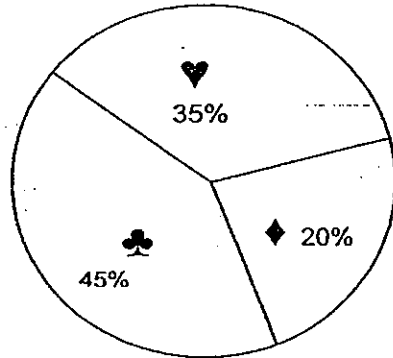

a) What changes do you expect to see in the percentage of Plant ♠ in three months?(1m)

---

b) Based on the map above, name the method of dispersal and state one characteristic each. (3m)

	Method of dispersal	Characteristics
♠		
♥		
♣		



37 The table below shows the colour change of a solution in the presence of carbon dioxide.

Colour of solution	Amount of carbon dioxide
Green	Lesser than the amount in the air
Yellow	Same amount as in the air
Red	Larger than the amount in the air

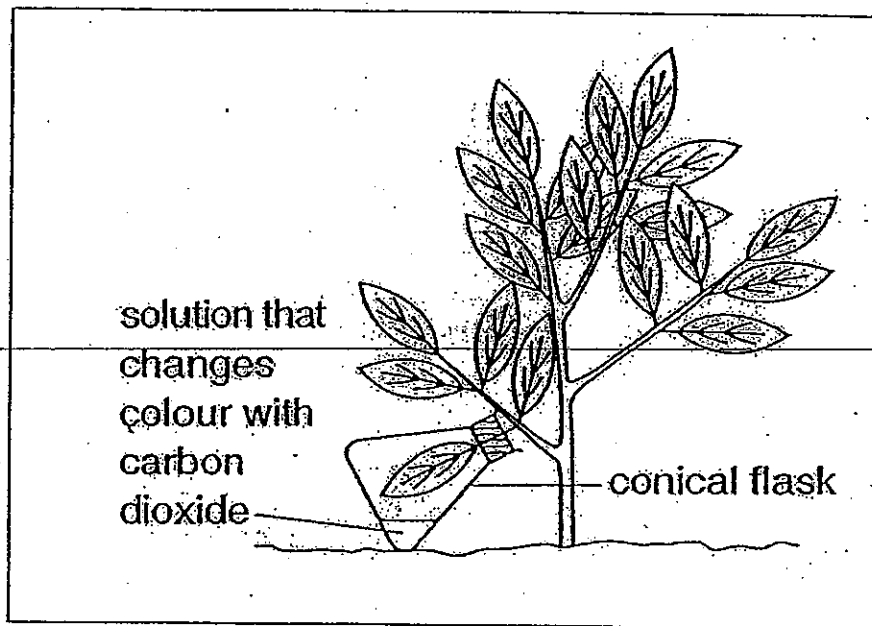

(a) Describe the colour of the solution at

(i) Noon: \_\_\_\_\_ (½m)

(ii) Midnight: \_\_\_\_\_ (½m)

(b) Explain your answer in (a). (2m)

# METHODIST GIRLS' SCHOOL

Founded in 1887



## PRIMARY 5 END-OF-YEAR EXAMINATION 2010 SCIENCE BOOKLET B2

Total Time : 1 hour 45 minutes

---

### INSTRUCTIONS TO CANDIDATES

Do not open the booklet until you are told to do so.  
Follow all instructions carefully.  
Answer all questions.

Name: \_\_\_\_\_ ( )

Class: Primary 5. \_\_\_\_\_

Date: 11 October 2010

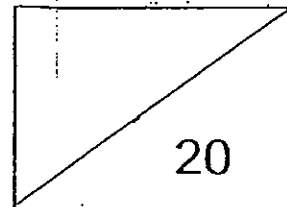

This booklet consists of 7 printed pages excluding cover page.

**Section B2: Open - ended Questions (7 questions = 20 marks)**

Read the questions carefully and write your answers in the spaces provided.

38. Study the diagram below.

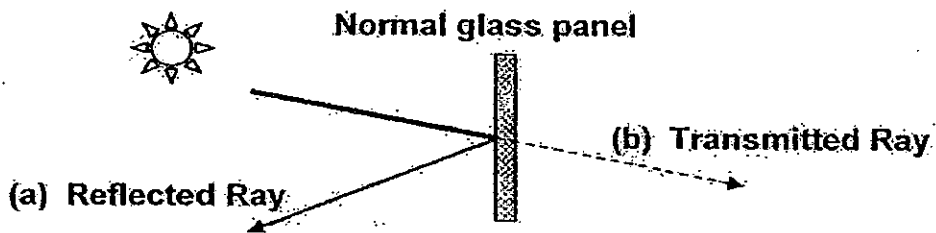

(a) List two properties of light that are demonstrated in the diagram above. (1m)

---

---

(b) How would the light transmitted through the frosted glass window be different from that of a normal transparent glass window? (1m)

---

---

(c) Mrs Wong wanted her house to be less warm. Which type of glass window as mentioned in (b) should she install? (1m)

---

---

39. Joseph applied some alcohol on his forearm and immediately felt a cooling sensation. He knows that alcohol is a liquid that vapourises very quickly.

(a) Why did Joseph feel the cooling sensation on the part of his skin where the alcohol was applied? (1m)

---

---

Joseph then placed a test-tube full of alcohol into his tea as shown below.

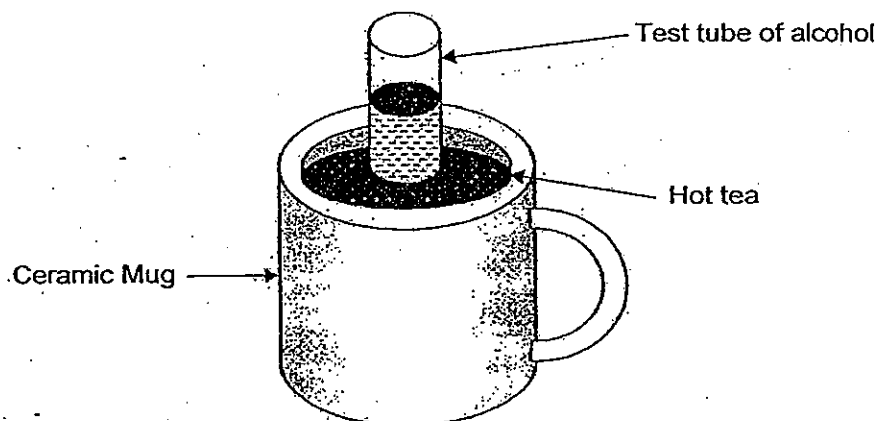

(b) What would happen to the temperature of Joseph's tea? Why? (2m)

---

---

---

---

40. Mr Muthu is an engineer who designed a model of solar still used to purify salt water. The solar still makes use of solar energy to heat up the sea water as shown in the diagram below.

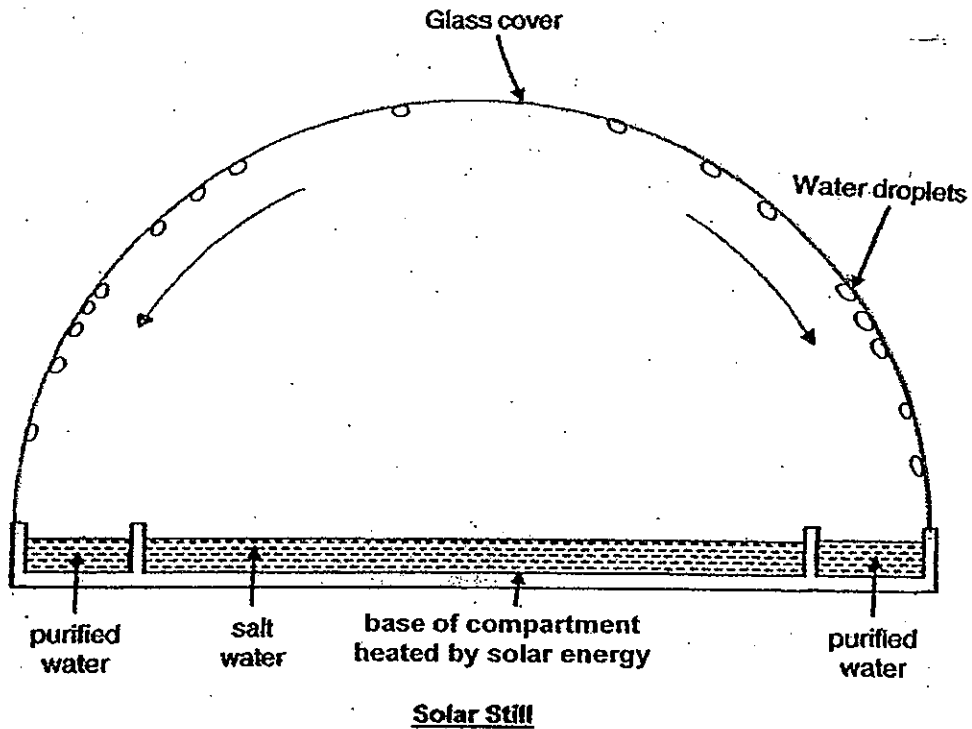

- a) Explain the process in which purified water is obtained from sea water. (2m)

---

---

---

---

---

- (b) Suggest one way in which Mr Muthu could modify his design of the solar still so that it can purify and collect water at a faster rate. (1m)

---

---

41. Study the 4 circuits W, X, Y & Z below.

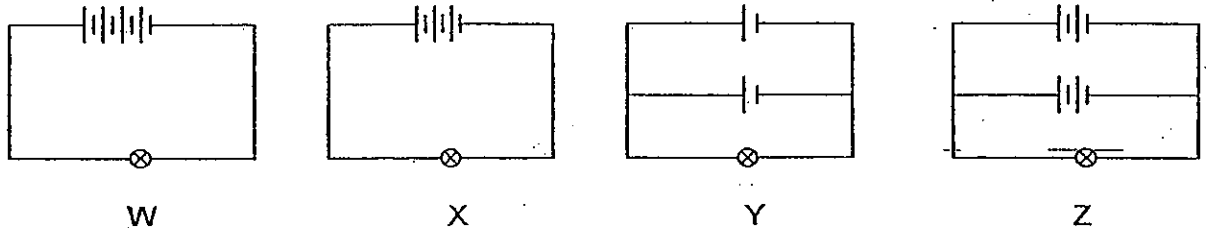

(a) Identical bulbs and batteries were used in the circuits shown above. When the circuits were connected, all the bulbs lit up.

Arrange the circuits W, X, Y and Z in ascending order of the brightness of the bulbs. (1m)

Bright  ,  ,  ,  Brightest

(b) Zaidi was given 4 pieces of unknown materials and a circuit tester with a bell. After testing the materials, he recorded his findings.

Material	Bell rang-	Useful as a covering for electrical wires?
A	Yes	
B	No	
C	No	
D	Yes	

Tick (✓) in the table above for material(s) that would be useful as a covering for electrical wires. (1m)

(c) Next, Zaidi wants to attach wires to three batteries in such a way that his bulb lights up the brightest. Complete the diagram below to show how he should attach the wires. (1m)

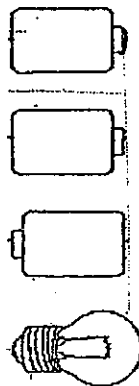

42. Candice and her group of friends carried out an experiment to find out which material used for the canopy allows the parachute to stay in the air for the longest time. The load remains constant for all the trials.

The diagram below shows the set-up which was dropped from a height.

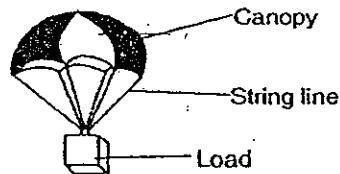

They recorded their findings as shown in the table below.

Trial	Material used in the canopy	Length of material used for the canopy (cm)	Length of string lines (cm)	Time to travel 12m (seconds)
1	Plastic film	35	35	32
2	Plastic film	35	45	30
3	Plastic film	25	45	25
4	Cotton cloth	35	35	30
5	Cotton cloth	25	35	20
6	Cotton cloth	25	35	22
7	Tracing paper	35	45	30
8	Tracing paper	35	35	31
9	Tracing paper	25	35	27

- (a) Based on the table above, which three trials can the students use to make a fair test comparison? (1m)

Trials \_\_\_\_\_

- (b) From the table above, which is the best material for making the canopy? (1m)

\_\_\_\_\_

- (c) Candice would like to find out if the mass of the load affects the time taken for the parachute to stay in the air. What should she do? (1m)

\_\_\_\_\_

\_\_\_\_\_

- 43a. Karen knows that turning the speed knob on the wall panel as shown below will affect how fast the ceiling fan moves. She also knows that the amount of electrical current flowing through the circuit can be controlled by the turning the knob.



What is the relationship between the amount of electrical current and the speed of the ceiling fan? (1m)

---



---

- 43b. Karen set up the three circuits as shown below. R and S are switches.

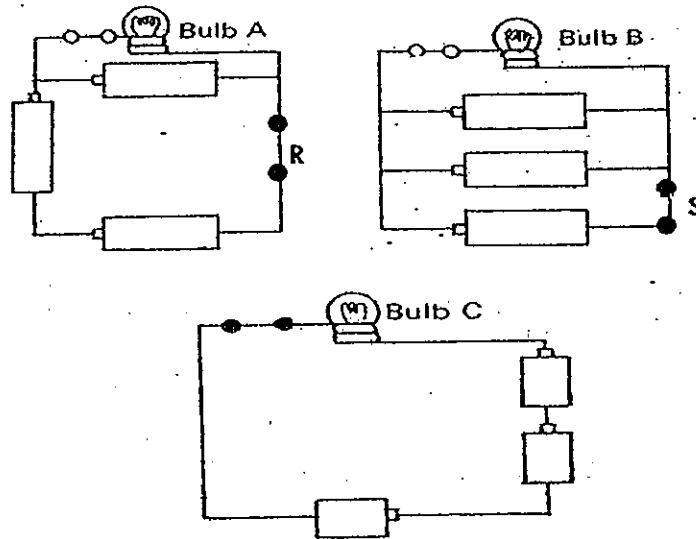

- (b) For each of the following statements, decide if they are true or false based on the above setup. (2m)

- A: Bulb A will light up even when switch R is open.
- B: Bulb B is brighter when switch S is open than when it is closed.
- C: Bulb C will become dimmer if one of the batteries is removed.

---



---



---



44. Tom has a two-piece device as shown below that cleans the algae in his tank. The device allows both sides of the fish tank to be cleaned at the same time. When part A, which is a magnet, is moved over the external glass surface of the fish tank, part B follows it, moving over the interior glass surface of the fish tank.

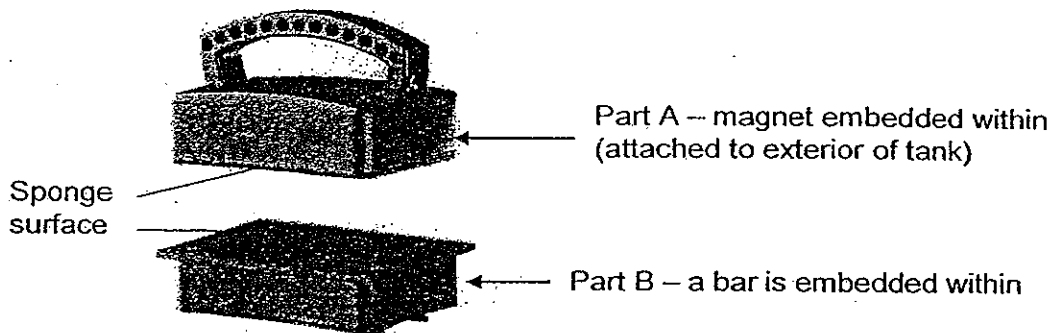

- (a) Name a material is most likely used to make the bar embedded within Part B? Explain your answer. (1m)

---

---

- (b) Tom tries to clean his metallic storage box using the same device but realises that Part B does not move together with Part A. Explain the most probable reason why this is so. (1m)

---

---



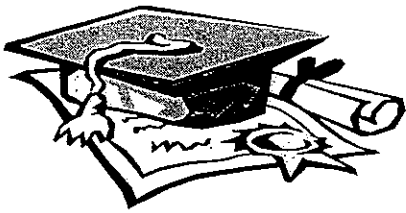

# ANSWER SHEET

**EXAM PAPER 2010**

**SCHOOL : MGS PRIMARY  
SUBJECT : PRIMARY 5 SCIENCE**

**TERM : SA2**

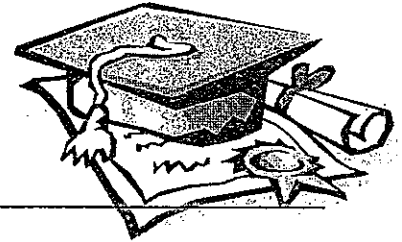

Q1	Q2	Q3	Q4	Q5	Q6	Q7	Q8	Q9	Q10	Q11	Q12	Q13	Q14	Q15	Q16	Q17
3	3	2	1	2	2	4	1	1	1	2	3	2	4	2	1	4

Q18	Q19	Q20	Q21	Q22	Q23	Q24	Q25	Q26	Q27	Q28	Q29	Q30
4	4	1	2	4	2	3	1	2	4	1	3	1

31)a)Organ P is the lungs.      b)Arrows B and D.

32)a)B    D                                      b)It has a fibrous husk.

33)a)She drew her father's side.  
b)Mei Hua has 2 uncles.  
c)Mei Hua has 1 sister and 1 brother.

34)a)Coloured fruits orange and red.  
b)The place where the pots are placed.  
c)The brighter the colour of fruits the more the birds will eat.

35)F   T   Not                      A: Red blood cell                      C: Nerve cell

36)a)I expect to see more of plant ◆ growing by the river side.  
b)Water-----Has a fibrous husk.  
Animals---- Has hooks.  
Explosive Action----It is Dry and hard.

37)a)i)Green    ii)Red  
b)At noon, the plant photosynthesizes and takes in carbon dioxide while at midnight, the plant respire and releases carbon dioxide.

38)a)Light travels in a straight line and light can be reflected.  
b)The light would be dimmer than the light from a normal transparent glass window.  
c)Mrs Wong should use the frosted glass window.

39)a) His arm lost heat to the alcohol for it vapourise, the lowering the temperature of the skin.

b) It would decrease. The tea loses heat to the test tube which turn loses heat to the alcohol causing it to vapourise, thus lowering the temperature of the tea.

40)a) Water would evaporate from the sea water as it is heated. When the water vapour touches the cool surface of the glass cover, it loses heat and condense to form water droplets which then fall to the sides of the solar still.

b) Mr Muthu could place some ice on the glass cover.

41)a) Y, Z, X, W

b) B, C

c)

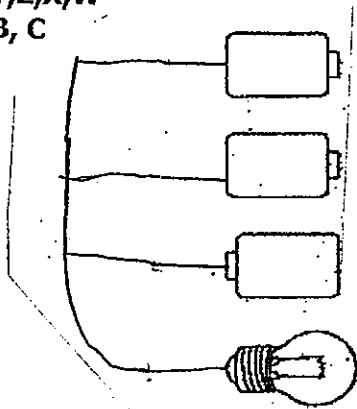

42)a) 1, 4, 8

b) Plastic film.

c) She should change only the mass of the load, and keep the rest of the variables the same.

43)a) The greater the amount of electrical current, the higher the speed of the ceiling fan.

b) A: T B: F C: T

44)a) A magnetic material. Any magnetic material such as iron, steel, nickel. Magnet can attract a magnetic material.

b) The box is made of a magnetic material and magnetic force cannot pass through it to attract Part B.