



NAN HUA PRIMARY SCHOOL
SEMESTRAL ASSESSMENT 2 – 2019
PRIMARY 5

SCIENCE

BOOKLET A

28 Multiple Choice Questions (56 marks)

Total Time for Booklets A and B : 1 hour 45 minutes

INSTRUCTIONS TO CANDIDATES

1. Write your name and index number in the space provided.
2. Do not turn over the page until you are told to do so.
3. Follow all instructions carefully.
4. Answer all questions.
5. Shade your answers in the Optical Answer Sheet (OAS) provided.

Marks Obtained

Booklet A		/ 56
Booklet B		/ 44
Total		/ 100

Name: _____ ()

Class: P 5

Date : 25 October 2019

Parent's Signature: _____

Section A: (28 × 2 marks = 56 marks)

For each question from 1 to 28, four options are given. One of them is the correct answer. Make your choice (1, 2, 3 or 4). Shade the correct oval (1, 2, 3 or 4) on the Optical Answer Sheet.

1 Which of the characteristic(s) shown below can be passed on from a parent plant to its young?

- A number of petals
- B colour of leaves
- C shape of leaves

- (1) C only
- (2) A and B only
- (3) A and C only
- (4) A, B and C

2 The diagrams below show the human reproductive systems, A and B.

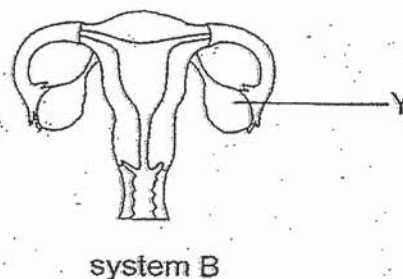
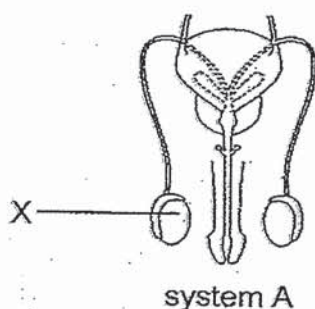

Which of the following statements about the systems is correct?

- (1) Part Y produces male reproductive cells
- (2) The fertilised egg will develop in system B.
- (3) System A is the human female reproductive system.
- (4) Parts X and Y produced the same type of reproductive cells.

3 The diagram below shows the human digestive system.

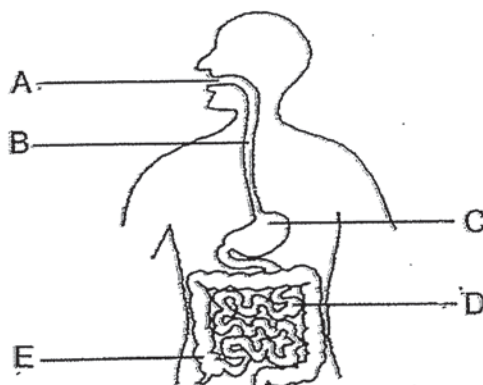

At which part(s) of the human digestive system is/are digestive juices added?

- (1) A only
- (2) B and E only
- (3) C and D only
- (4) A, C and D only

4 The diagram below shows the direction of blood flow in the human body.

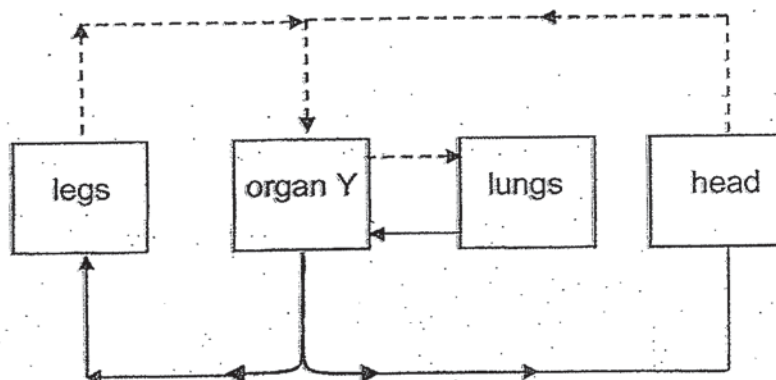

Which of the statement(s) about organ Y is/are correct?

- A It is part of the respiratory system.
- B It pumps blood to all parts of the body.
- C It allows gaseous exchange to take place.
- D It allows blood to flow through it twice to complete a circulation throughout the body.

- (1) B only
- (2) A and C only
- (3) B and D only
- (4) A, B and D only

- 5 The diagram below shows how three body systems work together. The arrows show the movement of some substances in the body.

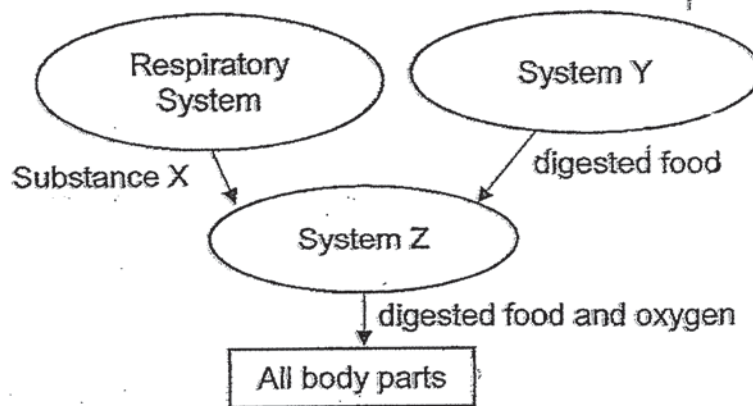

Which one of the following correctly matches substance X and body systems Y and Z?

	Substance X	System Y	System Z
(1)	carbon dioxide	circulatory	digestive
(2)	carbon dioxide	digestive	circulatory
(3)	oxygen	circulatory	digestive
(4)	oxygen	digestive	circulatory

- 6 The table below shows four different cells and the cells parts that were present in each cell. A tick (✓) indicates the presence of the cell part.

	Cell W	Cell X	Cell Y	Cell Z
nucleus	✓	✓	✓	✓
cell wall	✓		✓	
cytoplasm	✓	✓	✓	✓
chloroplast			✓	
cell membrane	✓	✓	✓	✓

Based on the table above, which of the following is correct?

	Leaf cell	Root cell	Cheek cell	Sperm cell
(1)	W	Y	X	Z
(2)	W	Z	Y	X
(3)	Y	Z	X	W
(4)	Y	W	X	Z

7 Which of the following about the Sun is false?

- (1) Only sunlight is needed by the plants to make food.
- (2) The Sun provides heat which keeps organisms warm.
- (3) The Sun is the main source of energy for all living things.
- (4) Plants can make use of the energy from the Sun to make food.

8 The diagram below shows the pod of a plant containing structure W.

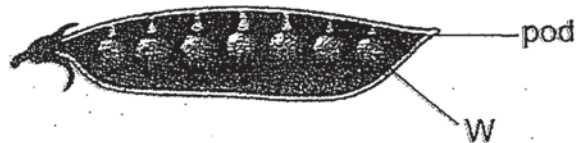

Which of the following statement(s) about W is/are correct?

- A W is the fruit of the plant.
- B W will grow into a new plant.
- C W can carry out photosynthesis.
- D Only pollination needs to take place for W to be produced.

- (1) B only
- (2) A and C only
- (3) B and D only
- (4) A, C and D

9 Ali picked up dust-like substances from the underside of the fern leaf Y and brushed it on the underside of another fern leaf X as he wanted reproduction to take place.

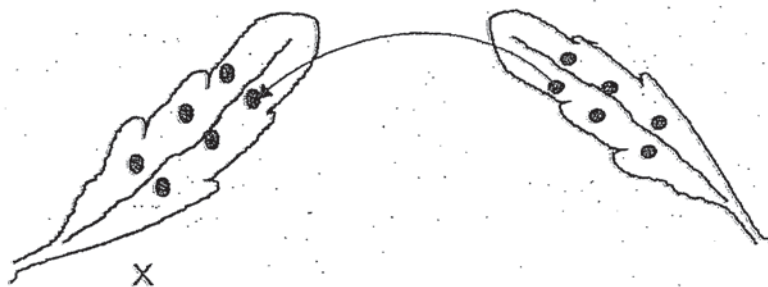

Which of the following statements about fern leaf X is correct?

- (1) Fern leaf X starts to produce flowers.
- (2) No reproduction will take place in fern leaf X.
- (3) The fern leaf starts to swell as fertilisation has taken place.
- (4) Pollination occurs when dust-like substance is brushed on it.

10 The diagram below shows the cross-section of a flower.

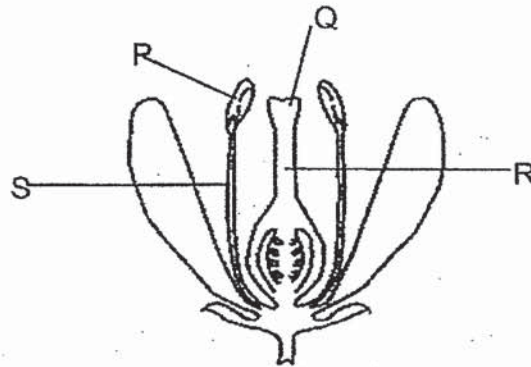

Which of the following correctly matches the plants reproductive parts, P, Q, R and S, and the human reproductive parts to their functions?

	Plant reproductive part	Human reproductive part	Function
(1)	P	testes	produces male reproductive cells
(2)	Q	ovary	produces the female egg cells
(3)	R	womb	place where fertilised egg cell will develop
(4)	S	penis	allows male reproductive cells to travel through to reach the female egg cell

11 Study the diagrams below carefully.

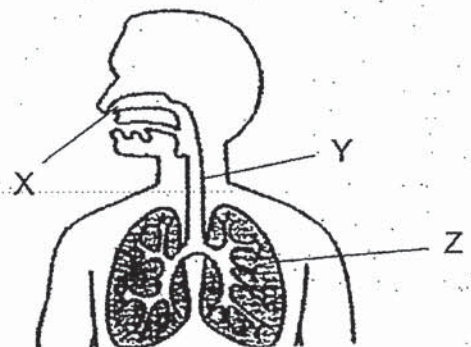
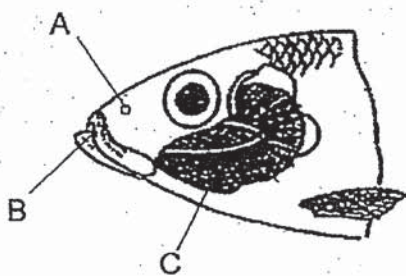

Which part of the fish and human will allow air from the surrounding to first enter the respiratory system?

- (1) A and X
- (2) B and X
- (3) C and Z
- (4) C and Y

- 12 The bar graph below shows the amount of undigested food and water leaving each part of the human digestive system after a person had a meal. The parts of the digestive system (A, B, C, D and E) are **not** arranged in sequence in the graph.

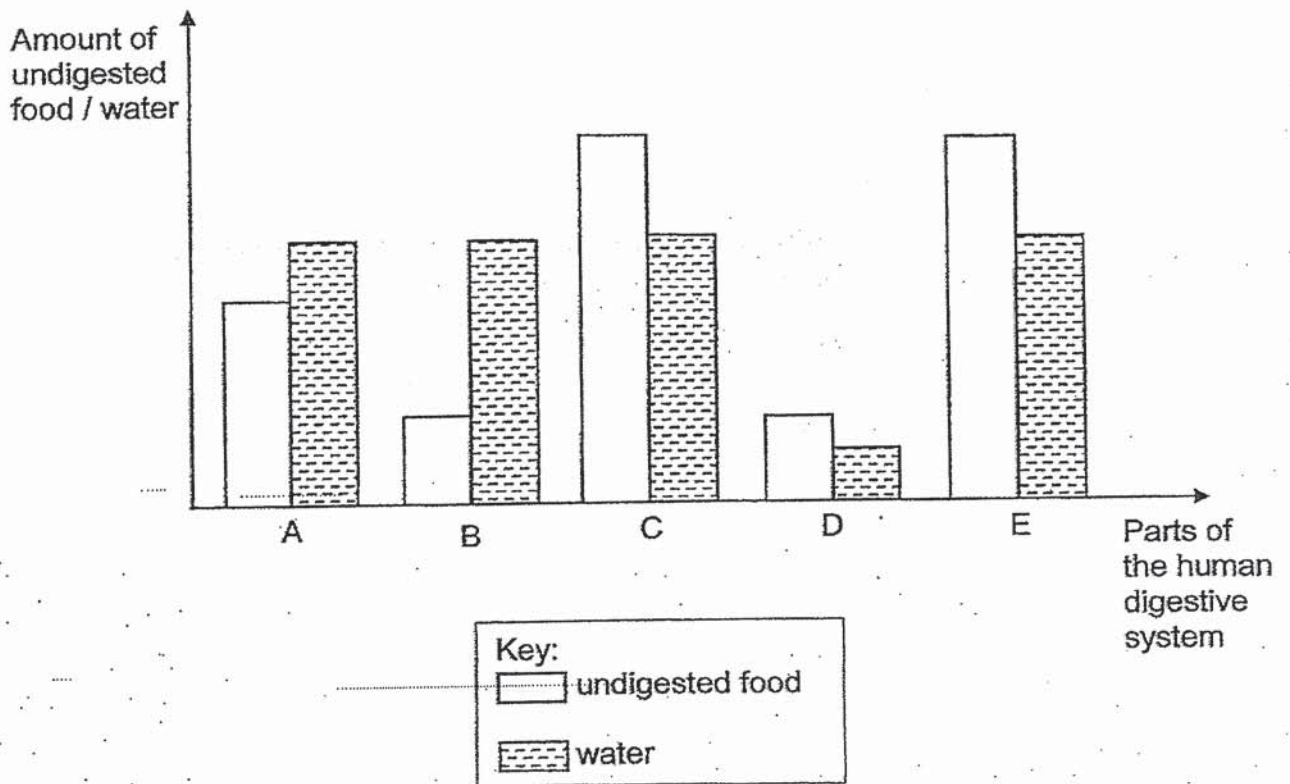

Based on the data given in the graph above, identify the parts, A, B, C, D and E and arrange them in sequence from the mouth to the large intestine

	Mouth	Gullet	Stomach	Small intestine	Large intestine
(1)	B	A	C	D	B
(2)	C	E	A	B	D
(3)	D	B	A	E	C
(4)	E	A	C	B	D

- 13 Which of the following shows the difference between how water is transported in the human and plant?

	Plant	Human
(1)	water moves in two different types of tubes	water moves in many different types of vessels
(2)	water is pumped to all parts	water is not pumped to all parts
(3)	water moves in one direction	water circulates in the body
(4)	water and food are found in same tube	water and digested food are found in different tubes

- 14 Benny, Casey, Daniel and Ethan each observed a different cell under a microscope and recorded the cell parts that are present in the cell in the table below.

	Cell parts
Benny	nucleus, cytoplasm, cell membrane
Casey	nucleus, cytoplasm, cell membrane, cell wall
Daniel	nucleus, cytoplasm, cell membrane, cell wall
Ethan	nucleus, cytoplasm, cell membrane, cell wall, chloroplast

They then each made a comment on their observation of their own slide.

	Comments
Benny	The cell is an animal cell.
Casey	The cell can make food as it is a plant cell.
Daniel	The cell has a fixed shape.
Ethan	The cell cannot be an animal cell since it has a cell wall.

Which student(s) could have made a **wrong** statement?

- (1) Benny only
- (2) Casey only
- (3) Casey and Daniel only
- (4) Benny, Daniel and Ethan only

- 15 Siew Li was transferring a young plant into a pot, she accidentally bent the stem as shown in the diagram below.

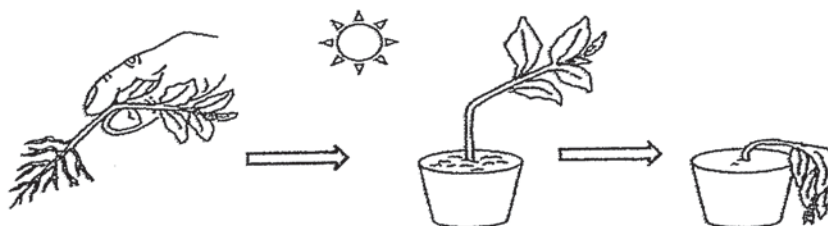

What caused the young plant to be unable to make food?

- A The leaves cannot receive sunlight.
 - B The leaves cannot receive carbon dioxide.
 - C The leaves cannot receive water from the soil.
 - D The leaves cannot receive nutrients from the soil.
- (1) C only
 (2) A and B only
 (3) C and D only
 (4) A, B and C only

- 16 The diagram below shows the processes involved in the water cycle.

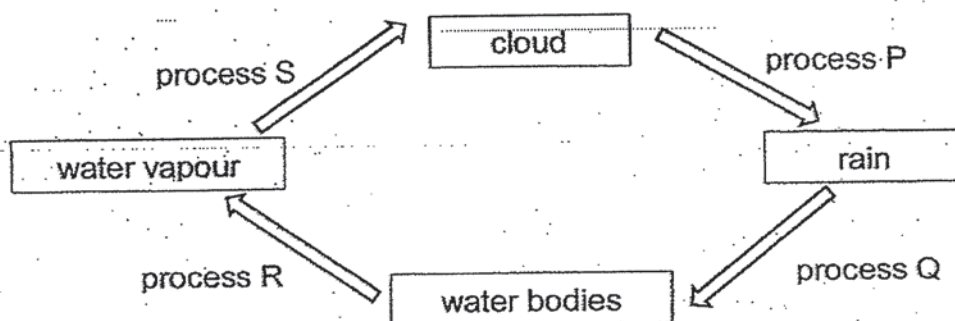

Sarah visited a country during winter. When she breathed out, she noticed a white mist forming as shown in the picture below.



Which of the processes, P, Q, R or S, in the water cycle above is the same process that forms the white mist?

- (1) P
- (2) Q
- (3) R
- (4) S

17 The diagram below shows two beakers of water being heated till the water boils.

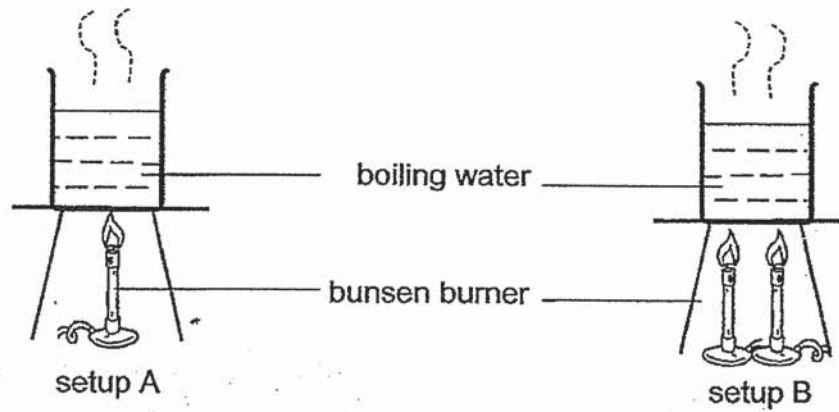

Which graph correctly represents setup A and setup B?

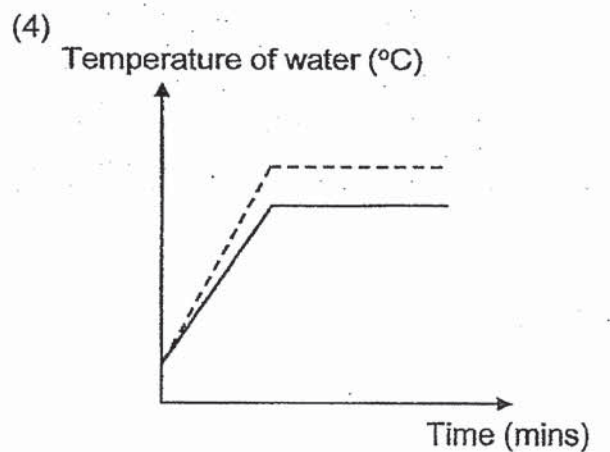
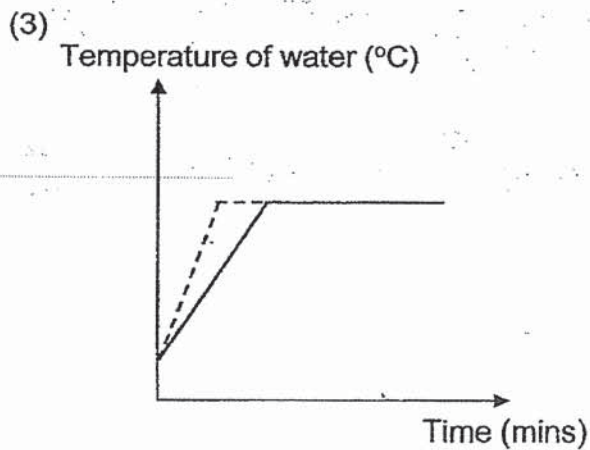
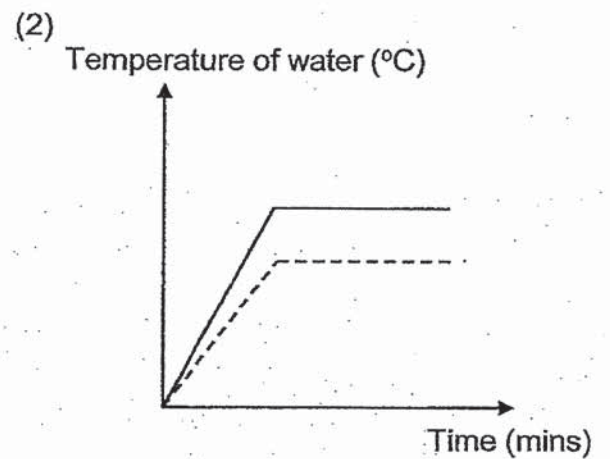
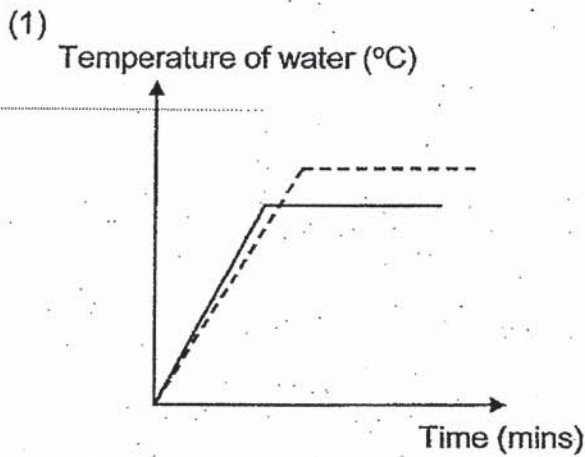
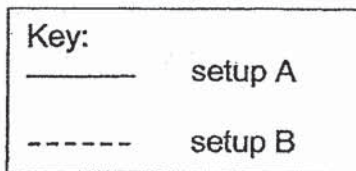

18 The diagram below shows an electric circuit.

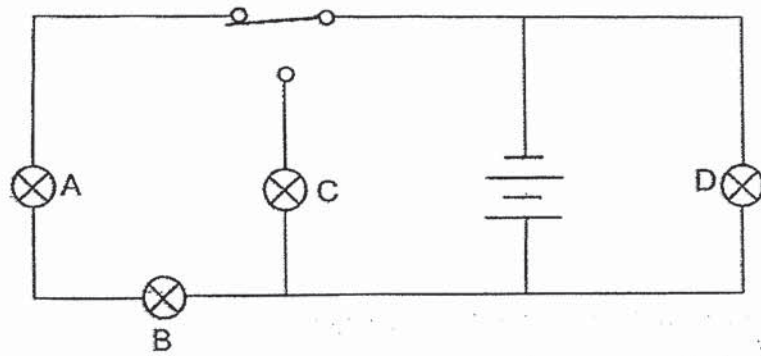

When the switch is at the current position, which bulb(s) will light up?

- (1) D only
- (2) A and B only
- (3) A, B and D only
- (4) A, B, C and D

- 19 The graph below shows the amount of electricity used by a household over a period of six months.

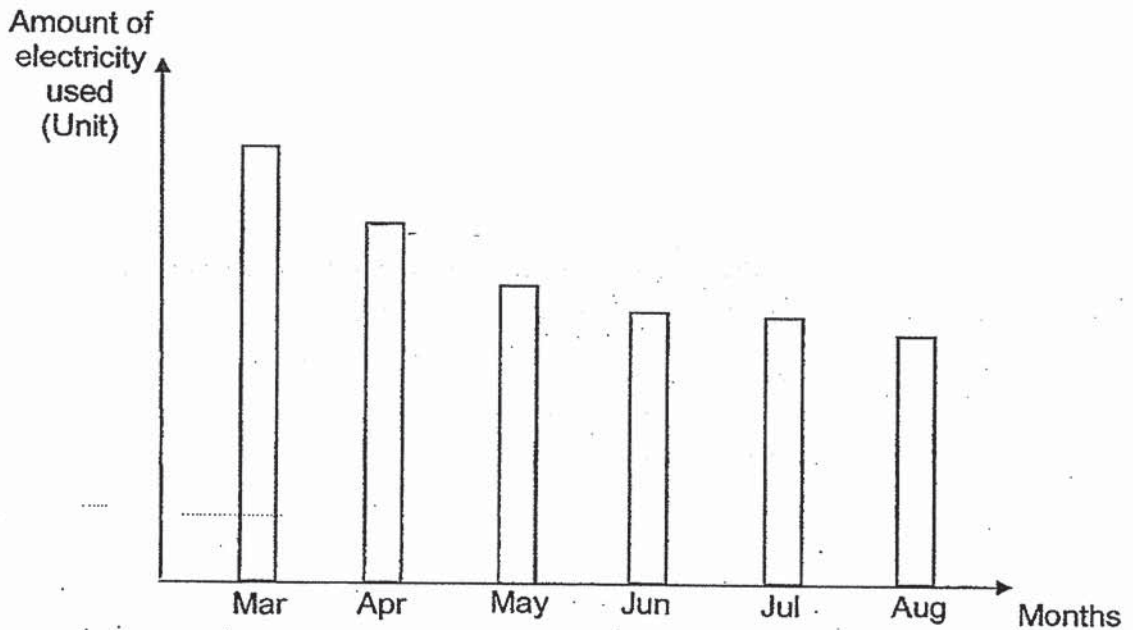

What could the members of the household have done in the past six months?

- A They charged their mobile phones overnight.
 - B They turned off all electrical appliances when not in used.
 - C They changed their refrigerator to an energy-efficient one.
 - D They turned on the air-conditioner instead of the fan at night.
- (1) C only
(2) A and D only
(3) B and C only
(4) A, B and D only

20 The diagram below shows a metal tool breaking the hard shell of a crab.

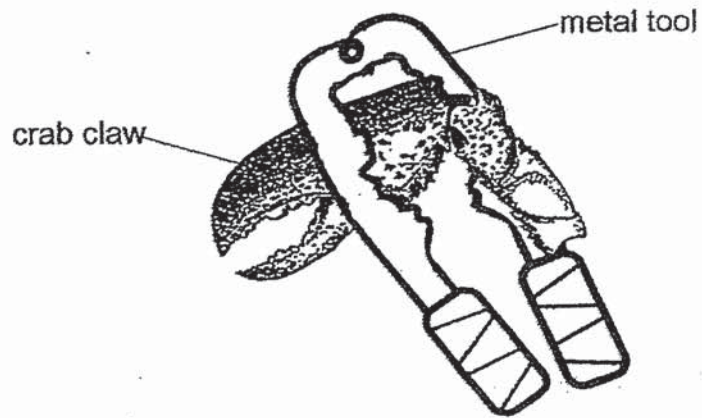

What property of metal is considered when making the tool?

- (1) strength
- (2) flexibility
- (3) transparency
- (4) conductivity of heat

21 The diagram below shows a rope being used to tie a hammock to a tree.

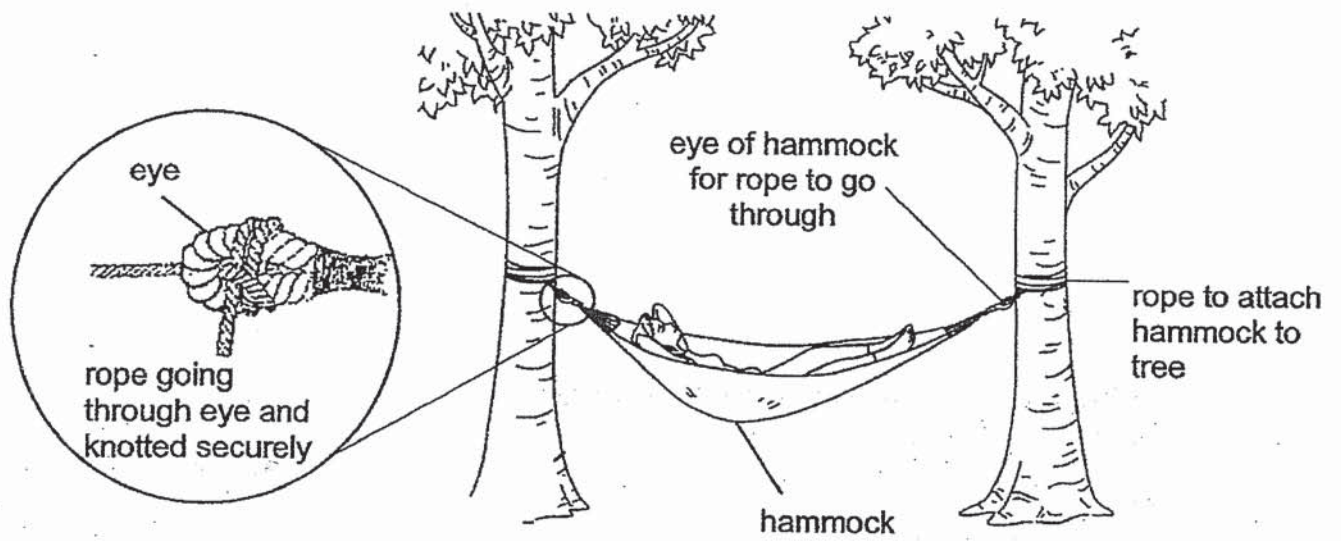

Which of the following property/properties must the rope has/have?

- A flexible
- B strength
- C waterproof

- (1) B only
- (2) C only
- (3) A and B only
- (4) B and C only

22 Frank hung two bars, X and Y, on strings as shown in the diagram below.

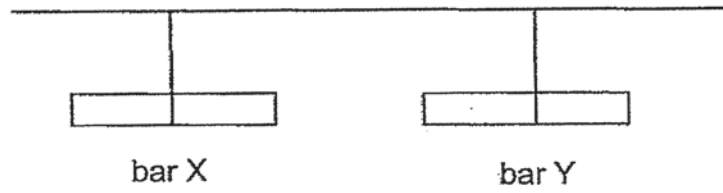

He then placed bar P between X and Y. Bar X remained at the same position whereas bar Y moved away from bar P.

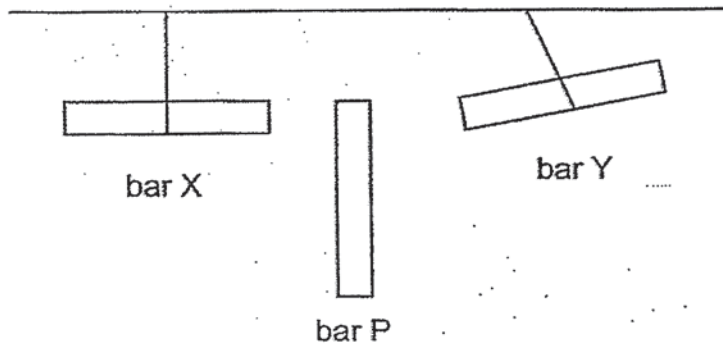

Which of the following correctly shows what materials, X, P and Y, are made of?

Materials			
	X	P	Y
(1)	steel	rubber	iron
(2)	wood	iron	steel
(3)	iron	plastic	wood
(4)	iron	steel	plastic

- 23 The diagram below shows one set of identical yellow balls and one set of identical blue balls being placed on each side of a balance scale. The two sets of balls are placed on the balance scale until the arms are balanced.

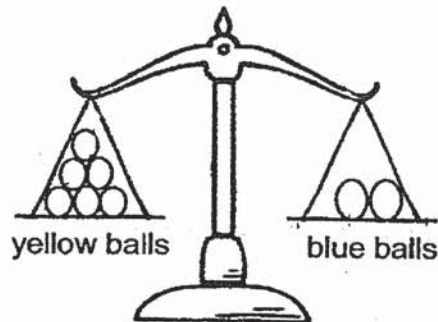

Which statement(s) about the two types of balls is/are correct?

- A The volume of both sets of balls are the same
- B The mass of both sets of balls are the same.
- C The mass of one blue ball is greater than the mass of one yellow ball.
- D The mass of all the blue balls is greater than the mass of all the yellow balls.

- (1) A only
- (2) B only
- (3) A and D only
- (4) B and C only

- 24 The diagrams below show four set-ups with equal amount of water at different temperatures.

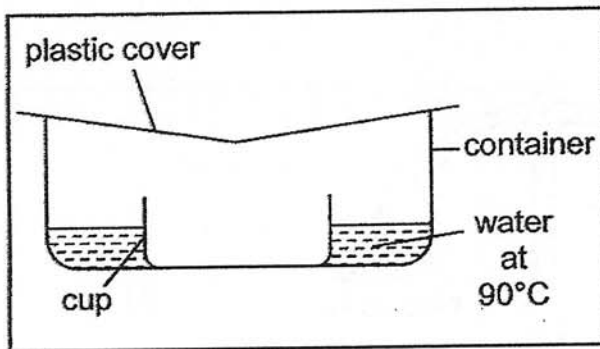

set-up W

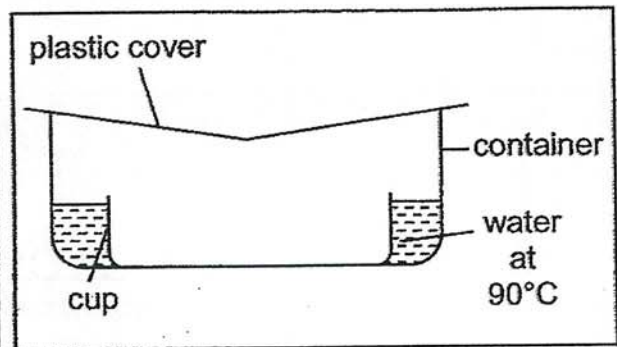

set-up X

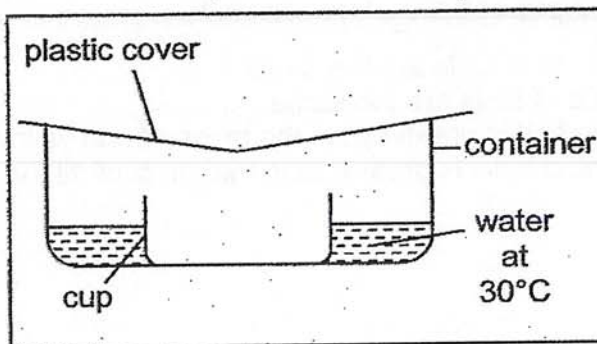

set-up Y

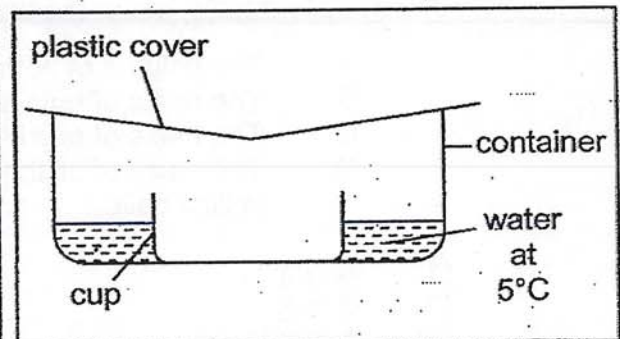

set-up Z

If the room temperature is 30°C, in which set-up will there be the most amount of water in the cup at the end of one hour?

- (1) W
- (2) X
- (3) Y
- (4) Z

- 25 An experiment was conducted where object X was placed on a piece of paper. The paper was held above a burning candle as seen in diagram A. When the candle was removed, the paper surrounding object X was slightly burnt, but not the part where object X was placed as shown in diagram B.

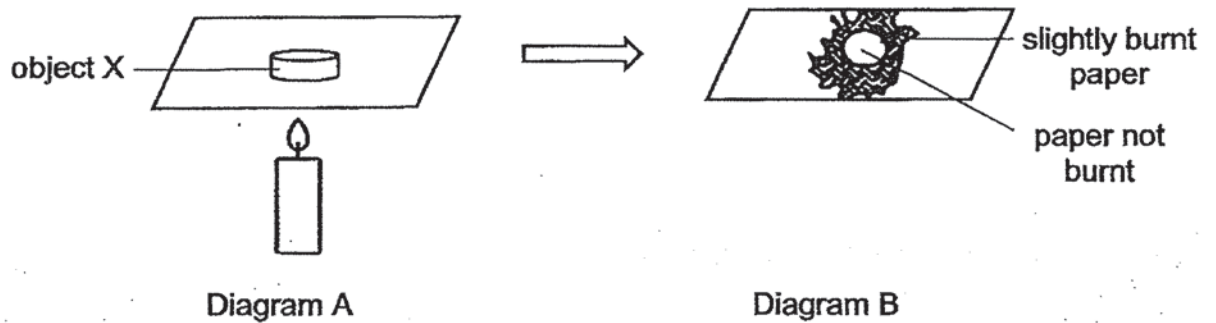

The same experiment was conducted with object W. The observation was shown below.

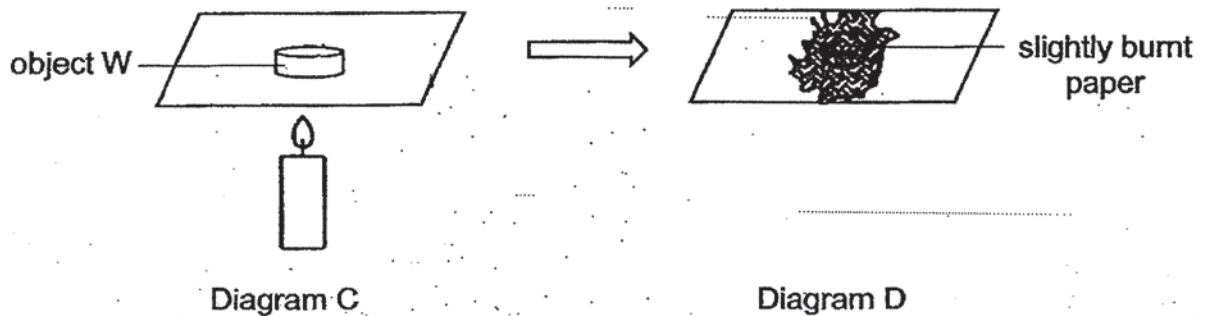

What is the heat conductivity of object X and W?

	Object X	Object W
(1)	good conductor	good conductor
(2)	good conductor	poor conductor
(3)	poor conductor	poor conductor
(4)	poor conductor	good conductor

- 26 The diagram below shows an electric circuit with all bulbs, batteries and switches in working condition.

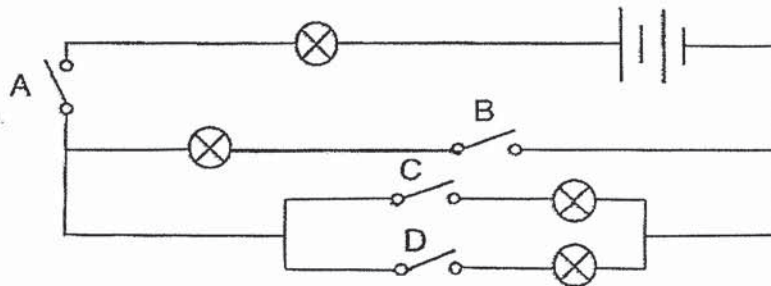

When all the switches were closed, all four bulbs lit up.
Which switch, when opened, will cause all the bulbs not to light up?

- (1) A
(2) B
(3) C
(4) D
- 27 Henry was given four different materials, iron, steel, silver and plastic. He was asked to connect them in positions, W, X, Y and Z in the circuit shown below.

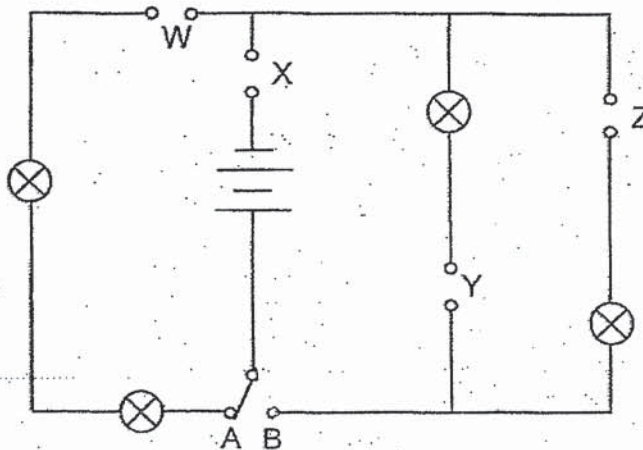

Which of the following arrangement will allow only one light bulb to light up?

	Position of switch	Type of materials at position			
		W	X	Y	Z
(1)	A	silver	plastic	iron	steel
(2)	A	iron	steel	plastic	silver
(3)	B	plastic	iron	silver	steel
(4)	B	steel	silver	plastic	iron

28 Owen set up an electric circuit as shown below.

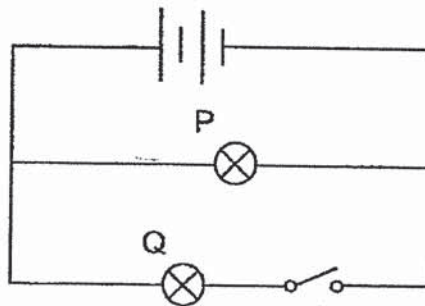

Owen then connected another identical bulb, R, to the circuit and measured the brightness of all three bulbs.

He found that the brightness of bulb Q did not change. However, the brightness of bulb P was decreased and it was as bright as bulb R.

Which of the following statements about Owen's circuit is true?

- A The switch can be used to control bulb R.
- B When bulb P fused, bulb R will not light up.
- C All the bulbs in the circuit are arranged in parallel.
- D When switch is open, only two bulbs will remain lit.

- (1) A only
- (2) A and C only
- (3) B and D only
- (4) B, C and D only



**NAN HUA PRIMARY SCHOOL
SEMESTRAL ASSESSMENT 2 – 2019
PRIMARY 5**

SCIENCE

BOOKLET B

12 Open-ended questions (44 marks)

Total Time for Booklets A and B : 1 hour 45 minutes

INSTRUCTIONS TO CANDIDATES

1. Write your name and index number in the space provided.
2. Do not turn over the page until you are told to do so.
3. Follow all instructions carefully.
4. Answer all questions.
5. Write your answers in this booklet.

Marks Obtained

Section B

	/ 44
--	------

Name: _____ ()

Class: P 5 _____

Date : 25 October 2019

Parent's Signature: _____

Section B: (44 marks)

Write your answers to question 29 to 40.

The number of marks available is shown in brackets [] at the end of each question or part question.

- 29 The bar chart below shows the amount of oxygen in four blood samples taken from four blood vessels, A, B, C and D, in the human circulatory system.

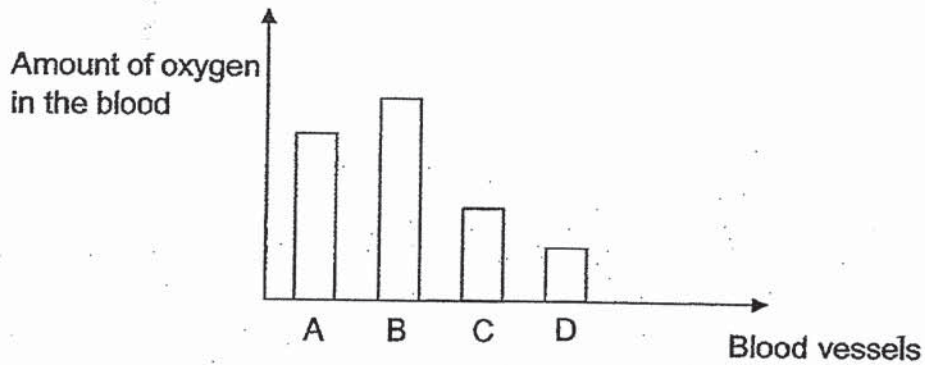

- (a) Which letter, A, B, C or D, represents the blood vessel that carries blood from the rest of the body back to the heart? [1]

- (b) Explain how blood is transported to the lungs and why it needs to be transported there. [2]

- (c) Explain why blood flows faster to the other parts of the body when we jog. [2]

Score	5
-------	---

30 Study the three cells and the flowchart below.

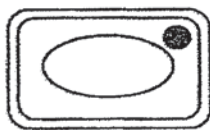

cell P



cell Q

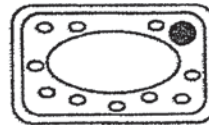

cell R

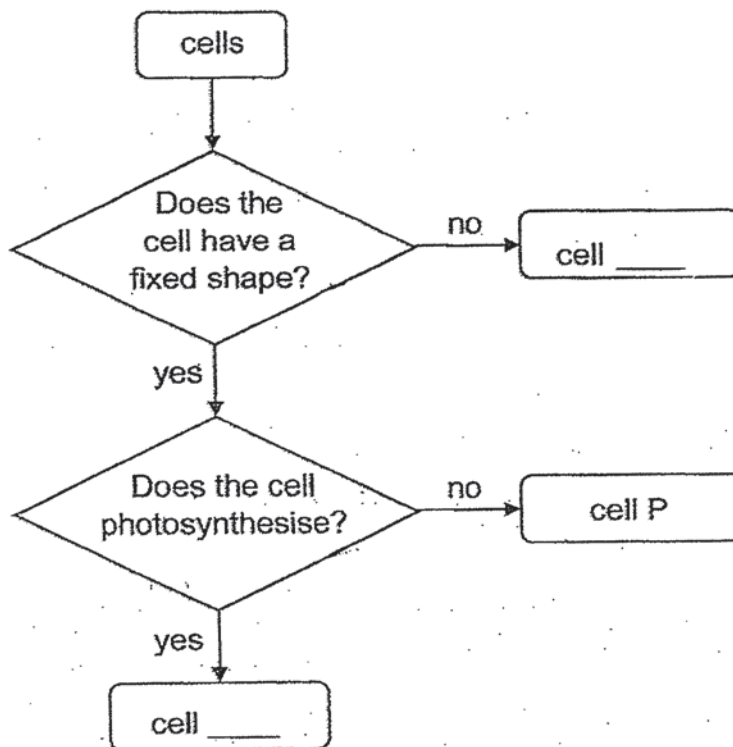

(a) Based on the flowchart above, state one characteristic of cell P. [1]

(b) Complete the flowchart by filling in the letters "Q" and "R" in the blanks above. [1]

(c) What is the cell part that is present in all plant cells but **not** in animal cells? [1]

Score	3
-------	---

- 31 The plants and the caterpillars are dependent on each other as shown in the diagram.

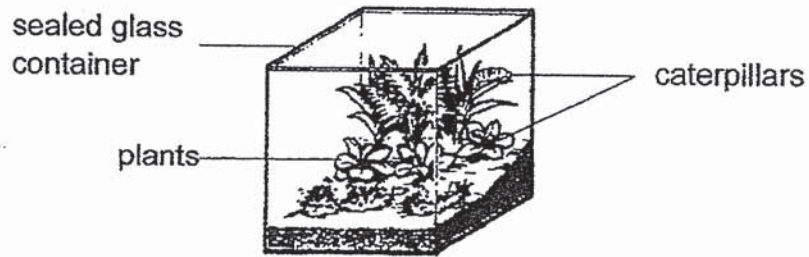

- (a) State a similarity in the way that plants and animals obtain energy.

[1]

- (b) Explain how the energy obtained by the caterpillar in the sealed container can be traced back to the Sun.

[2]

Score	3
-------	---

- 32 Devi set up the experiment as shown below in a dark room. The inverted test tube was completely filled with water at first.

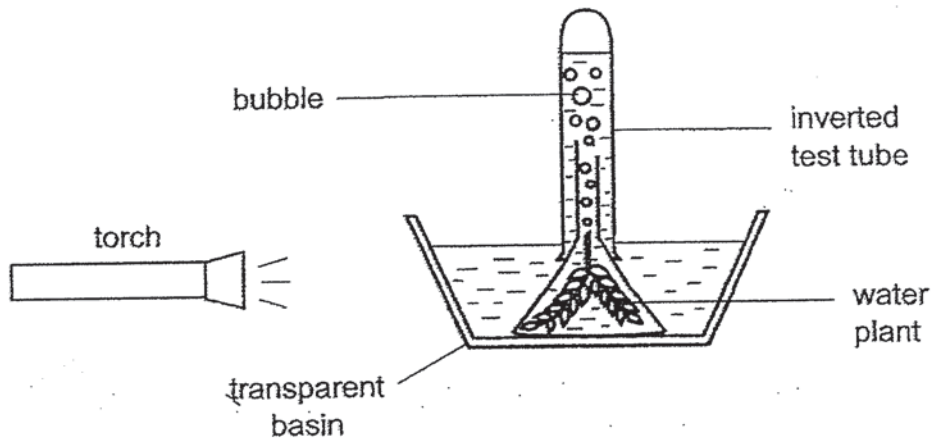

He shone the torch at the water plant for 30 minutes and recorded the number of bubbles given out by the plant. The results are recorded in the table below. He repeated the experiment using the same set-up but with torches of different light intensities in the same dark room.

Light intensity	Number of bubbles
Low	26
Medium	37
High	48

- (a) What was the relationship between the number of bubbles given out by the plant and the light intensity? [1]

- (b) What does the bubbles contain? [1]

(Go on to the next page)

Devi conducted another experiment using two similar plants. He placed one plant under the shade and another exposed to direct sunlight.

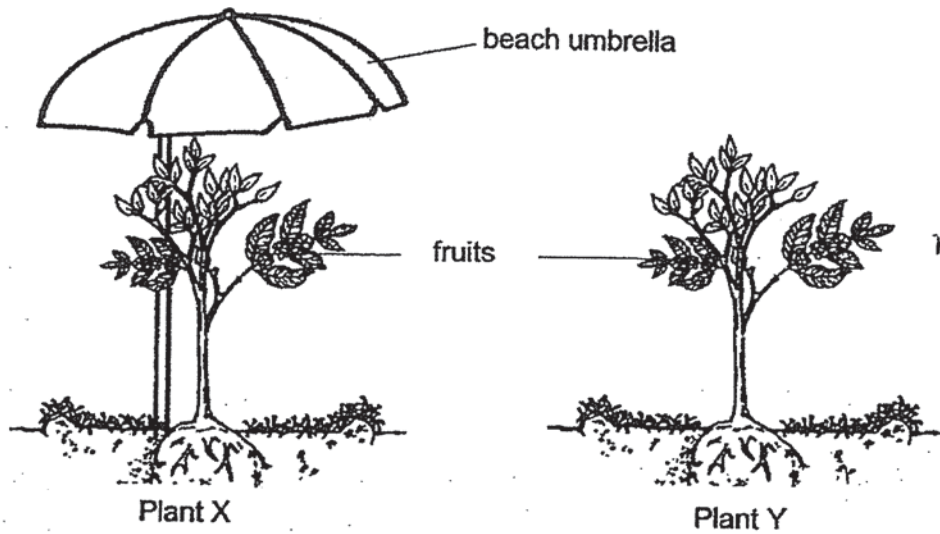

After some time, the two plants produced fruits as shown below.



- (c) Devi observed that plant Y, which was exposed to direct sunlight, produced bigger fruits compared to plant X.

Based on the information given in the experiment, explain why bigger fruits were produced by plant Y. [2]

- (d) The fruits of plant Y is fleshy. State the method of dispersal for the seeds of plant Y. [1]

Score	5
-------	---

33

Two seeds of plant X are used in an experiment. Both seeds are given all the suitable conditions for germination. The mass of the two seeds at the beginning of the experiment and observations of the seeds during the experiment are recorded below. The germinating seeds of plant X take about two weeks to grow its first pair of fully developed true leaves. This is longer than the average seedlings of other plants.

Seed	Mass of seed (g)	Did seed grow into an adult plant?
A	2	no
B	15	yes

(a) What is the function of the fully developed true leaves? [1]

(b) Using the information given, explain why seed B grew into an adult plant but not seed A. [2]

Score	3
-------	---

34 Ali prepared a set-up as shown in the diagram 1.

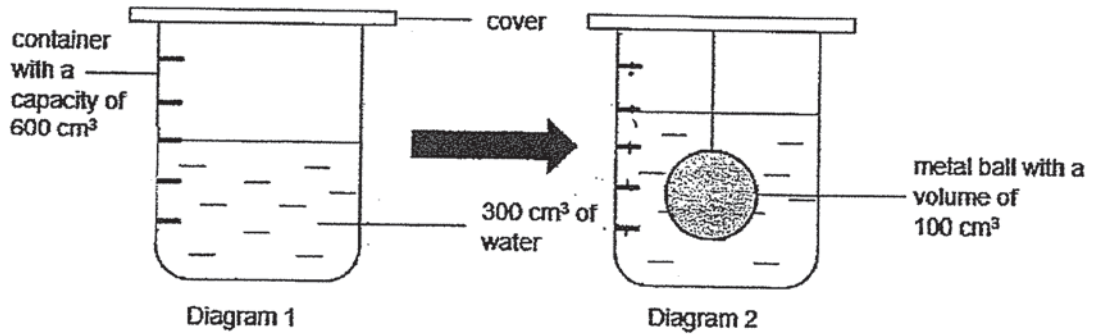

He then put in a metal ball with a volume of 100 cm³ and pumped in 100 cm³ of air into the container. He immediately sealed it as shown in diagram 2.

(a) State the change in the water level after he put in the metal ball. [1]

(b) Explain your answer in part (a). [2]

(c) What was the final volume of air in the container? [1]

Score	4
-------	---

35

The diagram below shows the cross-sectional view of a torch. The bulb lights up when the switch is pushed to the right.

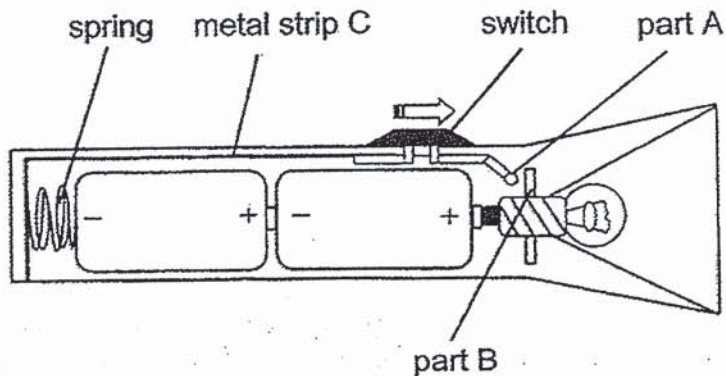

(a) Explain clearly why the bulb will light up when the switch is pushed in the direction as shown in the diagram above?

(b) Can the spring be made of plastic? Explain your answer. [1]

Score	3
-------	---

36 Peter recently bought a display cabinet to display some of his items as shown below.

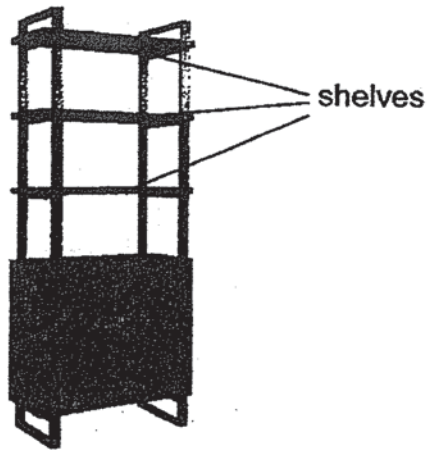

He decided to add one light at the bottom of each shelf so that his guests can see the items in the display cabinet clearly at night.

He also wanted to be able to control each light separately.

- (a) Using three bulbs and three switches, draw a circuit diagram to represent the electric circuit that Peter needs to construct for the lightings in his cabinet. The energy source (power supply) has been drawn for you. [2]

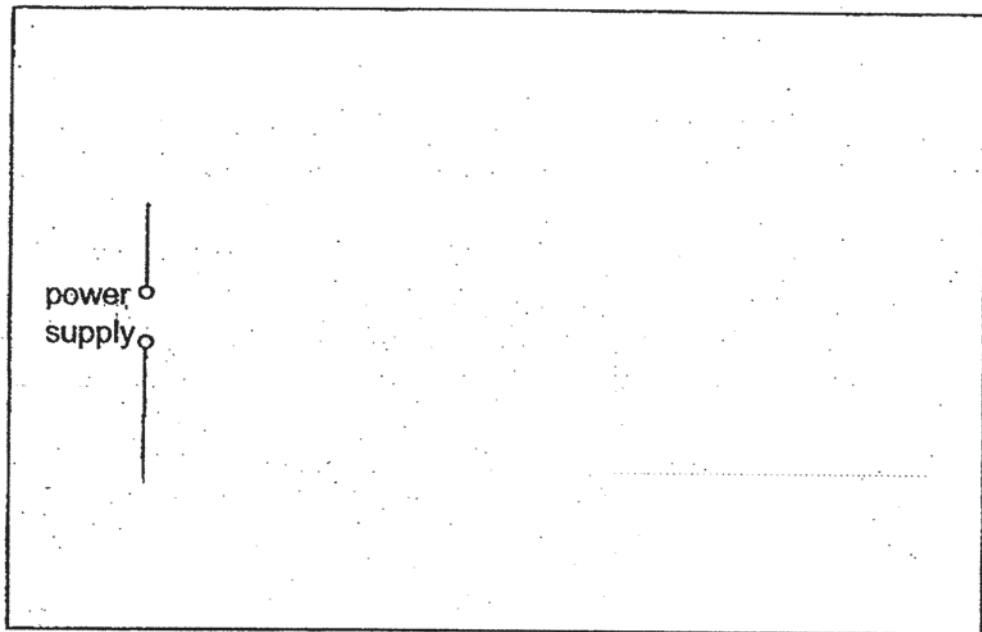

- (b) What would happen to the rest of the bulbs if one of the bulb fuses? [1]

Score	3
-------	---

- 37 Jeremy set up two circuits to find out how the arrangement of different number of bulbs in a circuit will affect the brightness each bulb.

The bulbs in one of the circuits are arranged in parallel. The bulbs in the other circuit are arranged in series.

He then plotted 2 graphs based on the results.

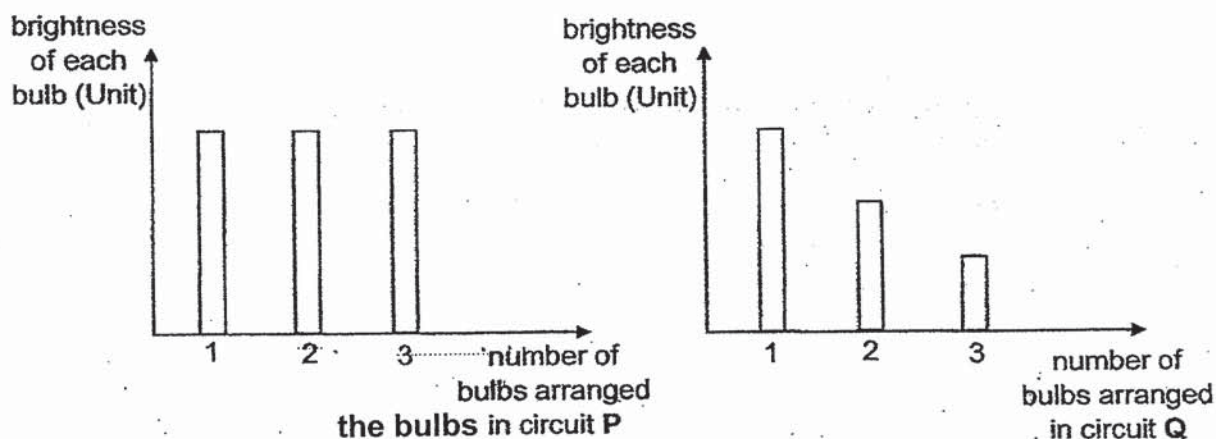

- (a) From the graphs above, what can Jeremy conclude about the arrangement of the bulbs in circuit P and Q? [1]

P: _____ Q: _____

- (b) Explain why Jeremy must use the same type of bulbs for both circuits. [1]

- (c) Jeremy wanted the bulbs in circuit P to shine more brightly. Suggest one thing he can do to the circuit to make the bulbs shine more brightly. [1]

Score	3
-------	---

- 38 Kate set up an experiment as shown below. When she closed the switch, she observed that object A moved a distance, d , away from rod W.

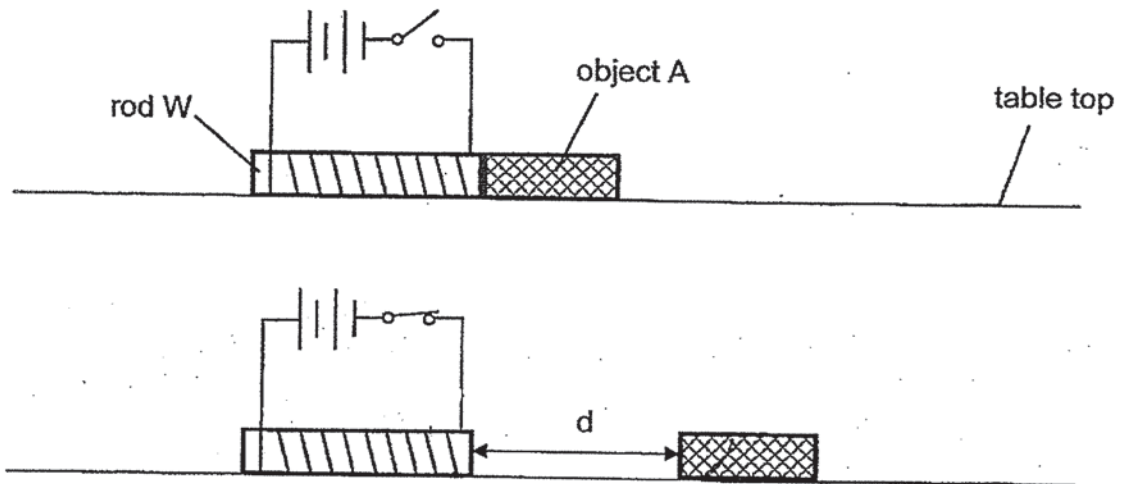

- (a) From the results of her experiment, what could Kate infer about object A? [1]

- (b) Explain clearly why object A moved away from the rod when the switch is closed. [2]

Kate then made a change in the set up and she noticed that the distance, d , increase.

- (c) State the change that Kate has made to the set up. [1]

- (d) Kate repeated the experiment two more times. What is the purpose of doing this? [1]

Score	5
-------	---

- 39 Mary prepared the following set-up and left it in a room with a temperature of 30°C for 30 minutes.

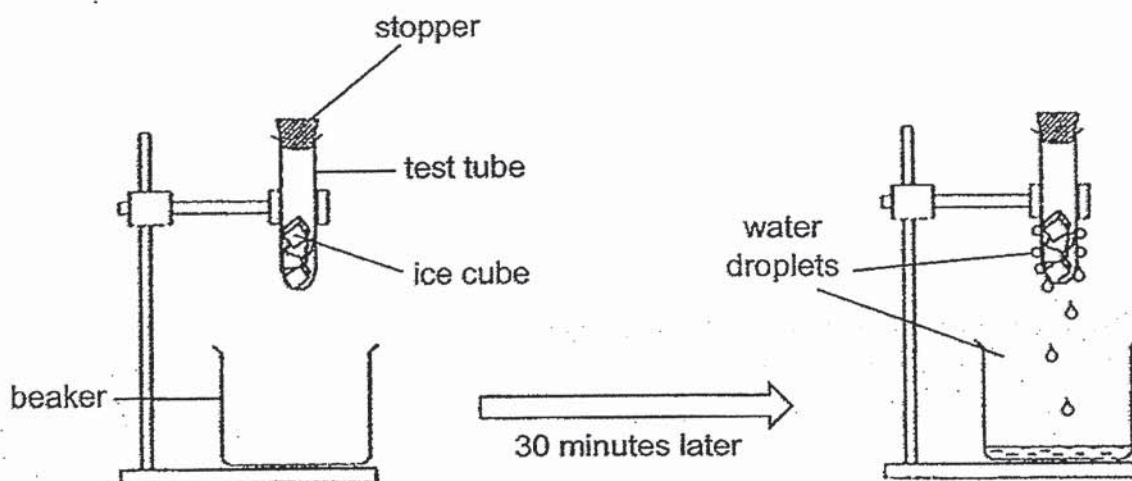

- (a) Explain what had happened in the 30 minutes that caused water to be collected in the beaker. [2]

(Go on to the next page)

Score	2
-------	---

After all the ice has melted, Mary removed the stopper at the top of the test tube and replaced the beaker with another item. She left the set-up in the same room for 30 minutes.

She made observations at regular time intervals and recorded her observations in the table below.

	0 min	5 min	10 min	15 min	20 min	25 min	30 min
Temperature of water in test tube (°C)	0	46	73	94	100	100	100
Amount of water left in test tube (ml)	100	92	96	75	70	65	32

- (b) What was the item that Mary replaced the beaker with? [1]

- (c) The amount of water changes from 20 minutes to 30 minutes. Explain why. [1]

Ahmad commented that one of the readings in the table is wrong.

- (d) Circle the wrong reading in the table and suggest a possible reading in the blank provided below. [1]

Score	3
-------	---

40 The diagram below shows a rivet and two metal plates.

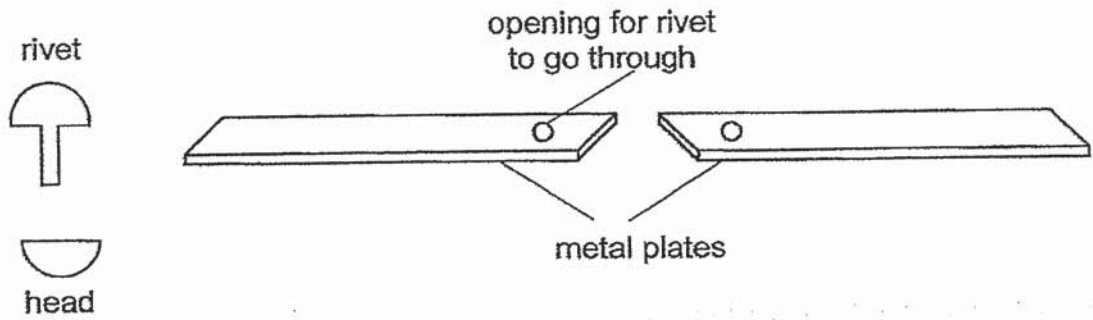

The diagrams below show how a rivet is to join two metal plates.

Step 1 - The rivet is put through the openings of two metal plates.

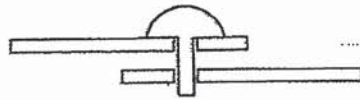

Step 2 - The rivet is then heated.

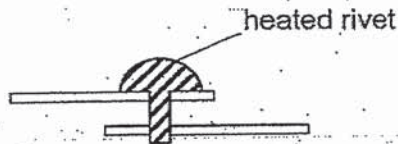

(a) Based on the diagram, explain why the rivet increase in size? [1]

(Go on to the next page)

Step 3 - The heated rivet is hammered into a head.

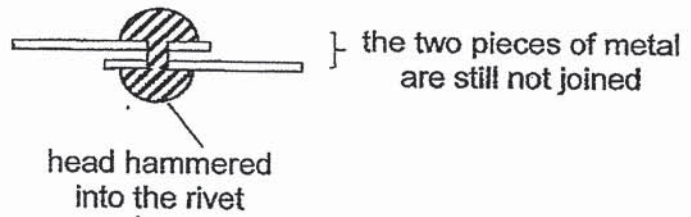

Step 4 - The rivet is left to cool.

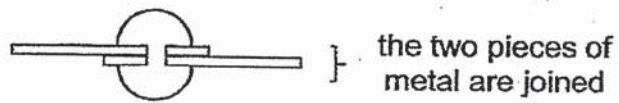

(b) How does the cooling of the hot rivet help to join the two pieces of metal? [1]

Score	2
-------	---

End of paper

1. 4
2. 2
3. 4
4. 3
5. 4
6. 4
7. 1
8. 1
9. 2
10. 1

11. 2
12. 2
13. 3
14. 2
15. 1
16. 4
17. 3
18. 3
19. 3
20. 1

21. 3
22. 2
23. 4
24. 1
25. 2
26. 1
27. 4
28. 3

Name: _____

Class: _____

Qn	D / C	MKS	Concepts
29a	The heart will pump the blood to the lungs.	1	Oxygen is used to carry out life processes
29b	At the lungs, the blood will absorb oxygen from the lungs and carbon dioxide in the blood is removed into the lungs.	2	Heart act as a pump for blood to go lungs for gaseous exchange
29c	Blood flows faster to supply more oxygen and (digested) food to all parts of the body, so that body has more energy to jog.	2	Vigorous activities cause blood to move faster for respiration to take place.
30a	Cell P has a fixed shape. OR Cell P does not photosynthesise / make food.	1	To be able to state a characteristic of a cell based on the flowchart.
30b	Cell Q, cell P	1/2 each	To be able to differentiate between a plant cell and animal cells based on their function and structure
		1	To know the difference in structure between a plant cell and animal cell
	the caterpillar obtain energy from food.	1	Food provide animals and plant with energy
	the caterpillar obtain energy from the plant directly when they eat the plant.	2	Organism get their energy indirectly from the Sun
	the plant obtain light (energy) from the Sun to make food. So the caterpillar get energy from the Sun indirectly.		
32a	The greater the light intensity/brighter the light, the greater the number of bubbles given out by the plant.	1	Identify r/s between dep and independent variables
32b	Oxygen	1	Product of photosynthesis
32c	Plant Y received greater intensity of light/more light, so there is greater rate of photosynthesis. More (excess) food is stored in the fruits.	2	Photosynthesis affecting quality of fruits
32d	By animals.	1	Identify characteristic of fruits when disperse by animals
33a	The true leaves (traps light) and make food for the seedling/germinating seeds/plant.	1	Function of leaves

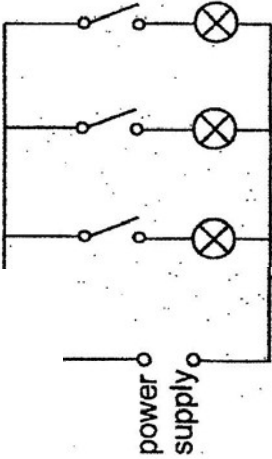
33b	The germinating seeds of B can have more stored food to develop into an adult. While seed A do not have enough food in the seed leaves for the seedling to develop into an adult plant.	2	Germination seed depends on food stored in seed leaves before they can make food.
34a	The water level rises / The water increases in height	1	Making correct observation in an experiment
34b	Water and cuboid has a fixed volume. Cuboid will occupy the space once occupied by the water.	2	Identifying properties of liquid and solid
34c	200 cm ³	1	Identifying the property of gas
35a	When the switch is pushed to the right, part A will come into contact with part B and the circuit is closed. Electric current can flow through the circuit and the bulb will light up.	2	To recognize that an electric circuit is made up of different components and that the circuit must be closed before an electric current can flow through it
35b	N a conductor of electricity.	1	To understand that only conductors of electricity allows electricity to flow through it To be able to construct a simple electric circuit using the proper circuit symbols
36a	 <p>power supply</p>	2 or 0	
36b	The rest of the bulbs will still be lit.	1	To understand that a separate current flows through each bulb connected in parallel
37a	(i) Parallel (ii) Series	½ each	To be able to analyse the graph and deduce the arrangement of the bulb
37b	It is ensure that the brightness of the bulbs is due to the arrangement of the bulbs and not due to the type of bulbs.	1	To understand that all the other variables has to be kept constant for a fair test

37c	He can increase the number of batteries connected to the circuit.	1	To understand that increasing the number of batteries helps to increase the amount of electric current flowing through the circuit
38a	Is a magnet	1	To understand that only magnets will repel each other
38b	When the switch is closed, electric current can flow through the circuit and rod W became an electromagnet. As the like poles of the electromagnet and object A are facing each other, the electromagnet repelled object A, causing object A to move away from it.	2	To understand how an electromagnet works and also that magnets with like poles facing each other will repel
38c	Increase the number of coils of wire around the electromagnet. Increase the number of batteries	1	To understand the variables that affect the strength of an electromagnet
38d	It is to e ility of the results. surroundings touches the cooler outer (loses heat to it) and condenses into tiny water droplets.	1	To understand that repetition of the experiment ensures the reliability of the result
		2	To understand the process of condensation
39b	Bunsen burner / heater / any form of heat source capable of causing water to boil	1	To be able to link the presence of the item to the increase in the temperature of the water till boiling point
39c	The water gained heat from the bunsen burner and boiled. Some of the water changed into steam.	1	To understand the effect of heat gained by the water.
39d	Circle 92 [1/2] Any answers between 96 and 100 [1/2] OR Circle 96 [1/2] Any answers between 75 and 92 [1/2]	1	To understand as temperature increases, rate of evaporation increases
40a	The rivet gain heat and expanded.	1	The circling must be done correctly before the 2 nd 1/2 mark is awarded.
40b	The rivet lost heat and contracted, pulling the metal plates together.	1	solid expand when it gain heat solid contract when it lose heat