



Rulang Primary School

END OF YEAR EXAMINATION SCIENCE 2022

Name: _____) Marks: _____ / 44

Level: Primary 5

Date: 1 Nov 2022

Class: Primary 5 ()

Parent's

Signature: _____

BOOKLET B

Instructions to pupils:

1. Do not open this booklet until you are told to do so.
2. You are required to answer all the questions in this paper using your own words / expressions as far as possible.
3. All drawings / diagrams must be clearly shown and labelled.
4. Marks will be deducted for wrongly spelt key words.
5. This question booklet consists of

16

 printed pages, including the cover page.

Section B (44 marks)

Write your answers to questions 29 to 40 in this booklet.

29. Jeremy examines two cells, X and Y, and concludes that they are taken from the same plant.

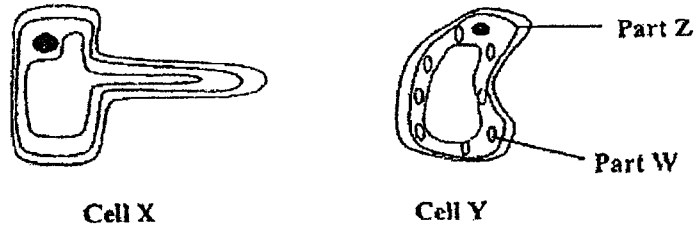

- (a) Is Jeremy's conclusion that cells X and Y are taken from the same plant correct? Explain your answer based on the diagrams above. [1]

- (b) Write down the name of part W. What does it contain and how does it help the plant? [2]

- (c) How does part Z protect the cell Y from harmful substances outside the cell? [1]

Total Score on this page:

30. Andy studied the positions of two different types of plants, X and Y, in field A as shown below.

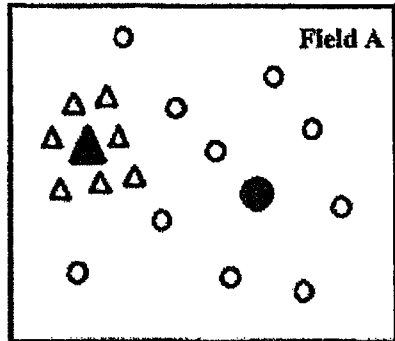

Key:

Plant	X	Y
Adult	▲	●
Young	△	○

(a)(i) Plant Y would grow more healthily than plant X. Explain why this was so based on the diagram above. [2]

The diagrams below show the fruits of plants X and Y.



Fruit P



Fruit Q

(a)(ii) Which fruit, P or Q, is the fruit of plant X? Explain your answer. [1]

Total Score on this page:

- (b) There were two fields, B and C, as shown below. At the beginning, field B had plants and animals, but field C had no plants and no animals.

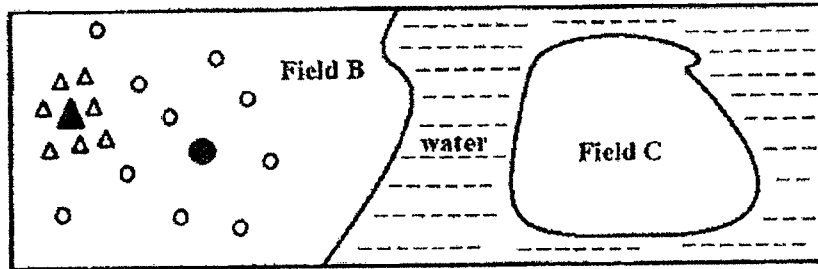

A few years later, field C started to have plants.

Describe two ways through which field C started to have plants.

[2]

Total Score on this page:

31. The diagram below shows a process that takes place in a female human body.

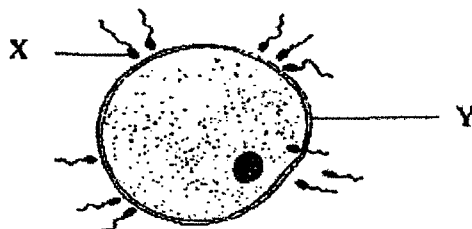

- (a) State and describe the process shown in the diagram above. [2]

- (b) Explain why there is a need to have many cell X. [1]

32. A packet of sausages wrapped in clear plastic was taken out from the freezer and placed on the dining table. After a while, a thin layer of white solid was formed on the surface of the plastic wrapper.

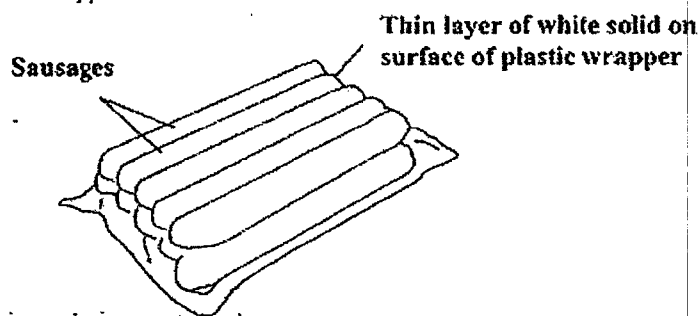

- Explain how the white solid was formed. [2]

Total Score on this page:	
------------------------------	--

33. Joanna filled three containers, A, B and C, with the same amount of tap water and left them in the same location.

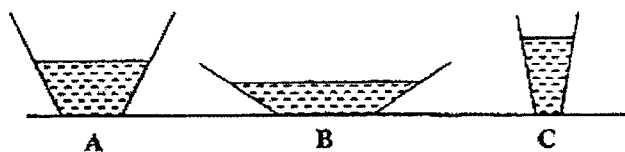

She measured and recorded the amount of water left in each container after one day in the table below.

Container	Volume of water in the container (cm ³)	
	Start of experiment	After one day
A	60	38
B	60	20
C	60	45

- (a) Based on the results, what can be concluded about the exposed surface area of the water in the container and the rate of evaporation of the water? [1]

- (b) Explain why placing all three containers at the same location would help ensure a fair test. [1]

- (c) Joanna conducted another experiment and filled container A with 60cm³ of hot water. The amount of water left in container A after one day was less than 38cm³. Explain why it was so. [1]

Total Score on this page:

34. The diagram below shows the stem of a plant with an outer ring removed.

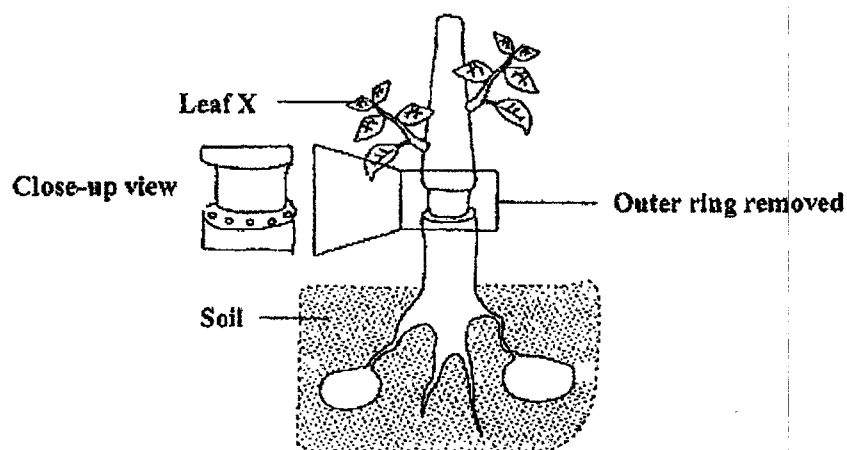

- (a) It was observed that leaf X continued to grow bigger after two weeks. Explain why this happened. [2]

An insect uses part Y to poke into the food-carrying tube of a stem.

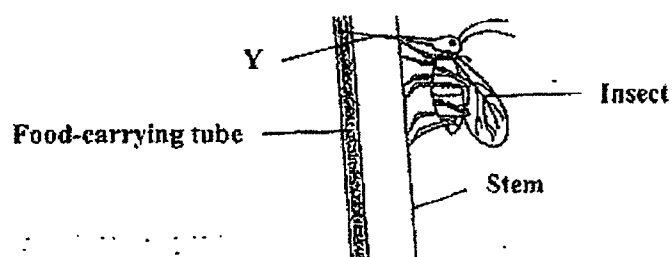

- (b) Explain how the roots of the plant could be affected after some time. [2]

Total Score
on this page:

35. The respiratory system plays an important role in humans.

(a) Name the three main parts that make up the human respiratory system. [1]

(b) Explain why the breathing rate of a person increases when he / she is running. [1]

(c) The respiratory system works with the circulatory system to remove a gas when we breathe out. Name the gas. [1]

36. Plants produce a gas when light is present. Michael set up an experiment, as shown below, to find out if the amount of light affects the amount of gas produced.

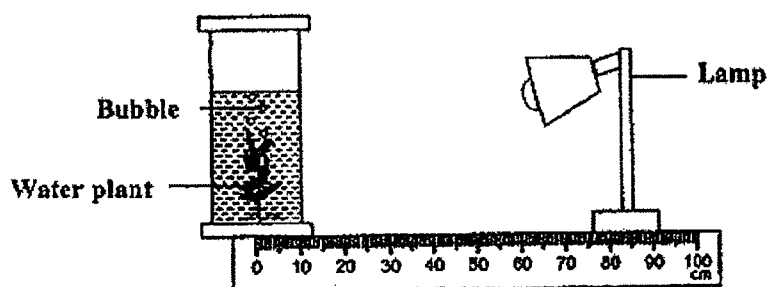

He placed a lamp at various distances and recorded the number of bubbles produced in one minute by the water plant. The results are shown in the table below.

Distance between the lamp and the water plant (cm)	20	40	60	80
Number of bubbles produced in one minute	25	17	8	3

- (a) Based on Michael's results, what is the relationship between the number of bubbles produced and the distance between the lamp and the water plant? [1]

- (b) Michael conducted the experiment in a dark room. Give a reason why this would have made the results more accurate. [1]

- (c) Michael found out later that the gas produced by the plant is oxygen when light is present. That gave him an idea of planting water plants in his pond as shown below.

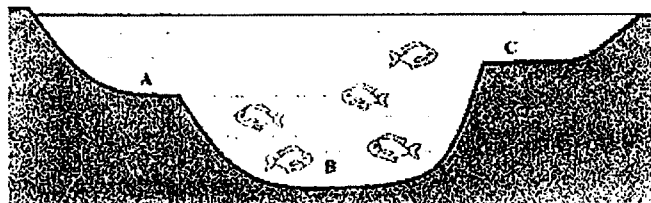

Based on the results of the experiment, Michael decided that he should avoid planting his water plants in the pond at B. Explain Michael's decision so that more fish would survive. [1]

37. Stephen wanted to find out if bars P, Q, R, S and T are electrical conductors. He set up the circuit as shown below.

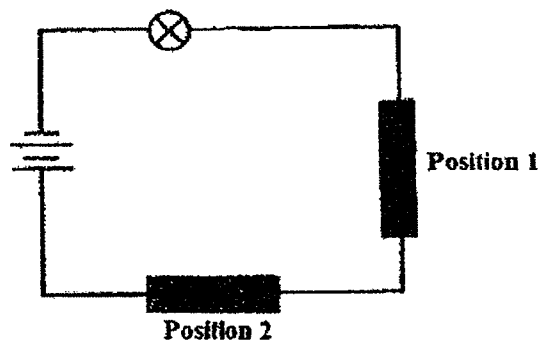

He placed the bars at positions 1 and 2 and recorded his observations in the table below.

Position 1	Position 2	Did the bulb light up?
P	Q	Yes
R	S	No
P	R	Yes
Q	T	No

- (a) Define an electrical conductor.

[1]

- (b) Complete the table below with P, Q, R, S and T in the correct column.

[2]

Electrical conductor(s)	Electrical insulator(s)

Total Score
on this page:

- (c) Stephen set up another circuit A and connected objects X, Y and Z to the circuit as shown below. All the bulbs and batteries were in working condition.

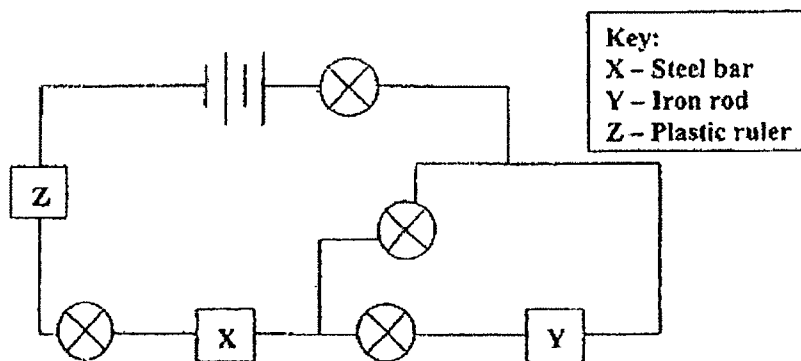

Circuit A

- (i) He observed that none of the bulbs in circuit A lit up. Explain why this was so. [1]

- (ii) At which positions in the circuit below should Stephen place objects X, Y and Z so that the most number of bulbs would be lit up?

Write X, Y or Z in each of the boxes provided below. Use each letter once only. [1]

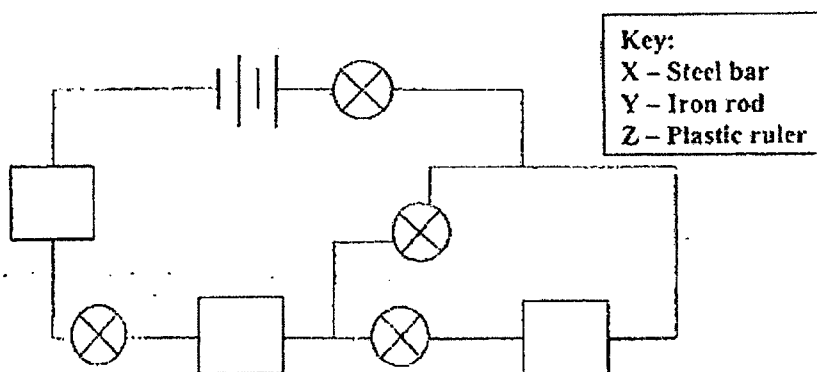

38. Noah conducted an experiment using 2 identical bulbs and 3 batteries. He set up two different circuits, C and D, and arranged the bulbs either in series or parallel. He recorded his results in the table below.

Number of bulbs in circuit	Brightness of each bulb in circuit C (units)	Brightness of each bulb in circuit D (units)
2	3	6

Next, he conducted another experiment using 3 identical bulbs and 3 batteries. Using the same bulb arrangement in the first experiment, he recorded his results in the table below.

Number of bulbs in circuit	Brightness of each bulb in circuit C (units)	Brightness of each bulb in circuit D (units)
3	2	6

- (a) Using 2 bulbs and 3 batteries for each circuit, complete the circuit diagram in each of the boxes below to show how the bulbs in circuits C and D are arranged in the first experiment. [2]

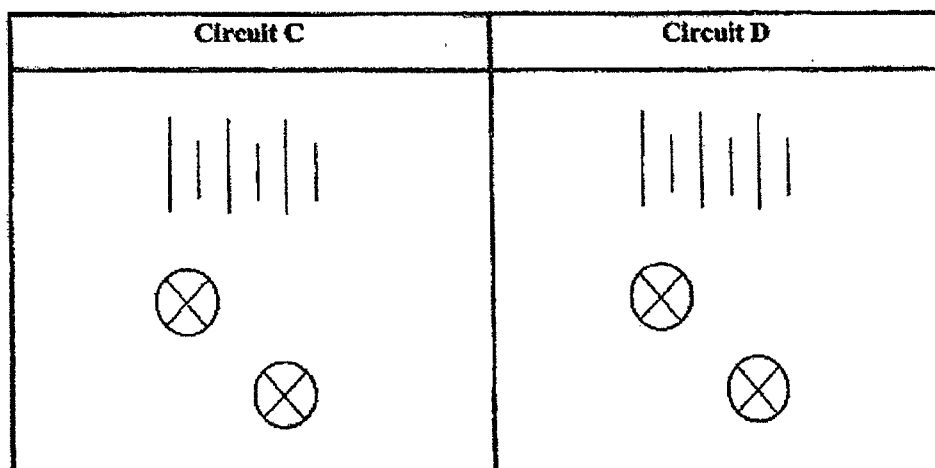

- (b) A bulb is removed from circuit C in the diagram above. What would happen to the brightness of the other bulb when the wires are connected again? [1]

- (c) State an advantage of circuit D as compared to circuit C. [1]

39. Insyirah wanted to find out whether the different colours of 2 containers will affect the rate at which water in the containers gains heat. She prepared two set-ups, S and T, as shown below, using 2 containers of different colours and placed them outside under the Sun for two hours.

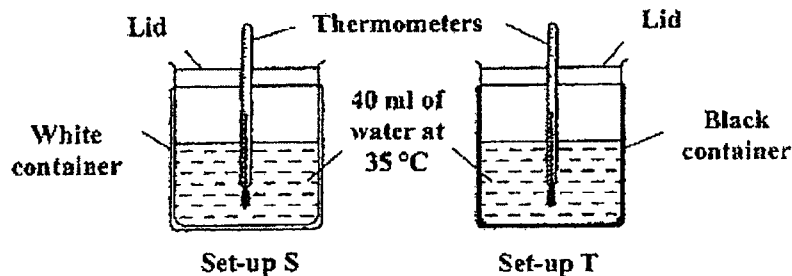

The results are shown in the graph below.

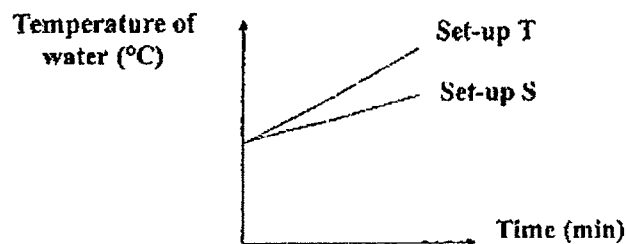

- (a) Based on the graphs above, what could Insyirah conclude about her experiment? [1]

- (b) Insyirah observed more tiny water droplets forming on the underside of the lid of the black container than the white one after some time.

Based on the graphs above, explain your answer. [2]

<p>Total Score on this page:</p>

40. Gopal conducted an experiment to investigate how 'bubble wrap' affects the temperature of water. He used two identical containers as shown below.

Container A was covered with "bubble wrap" that contains air pockets while container B was covered with "bubble wrap" but the air pockets were burst and the wrap did not have air in the pockets. Both containers were filled with hot water.

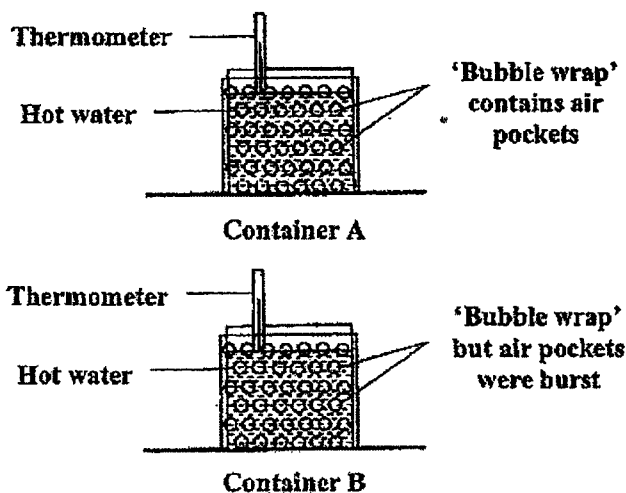

- (a) What are the variables that must remain the same for a fair test?

[1]

Variables	Tick (✓) the variables to remain the same
Amount of water	
Temperature of water	
Size of containers	

- (b) Gopal recorded the temperature of water in containers A and B over time in the graph shown below.

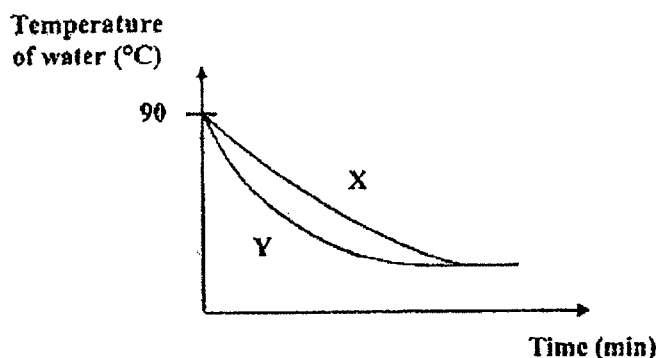

Based on the graph above, explain why line Y represents the change of temperature of water in container B. [2]

- (c) A restaurant prepares fried ice cream to sell as desserts as shown below. A slab of ice cream is covered with flour batter that is whipped to create air bubbles. The ice cream is then fried in hot oil where the batter is cooked.

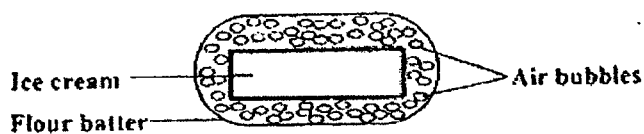

Explain why the ice cream does not melt easily while it is being fried in hot oil. [2]

END OF PAPER

SCHOOL : RULANG PRIMARY SCHOOL
 LEVEL : PRIMARY 5
 SUBJECT : SCIENCE
 TERM : 2022 SA2

SECTION A

Q 1	Q2	Q3	Q4	Q5	Q6	Q7	Q8	Q9	Q10
3	4	2	3	1	2	4	1	1	3
Q 11	Q12	Q13	Q14	Q15	Q16	Q17	Q18	Q19	Q20
3	1	3	2	4	3	4	2	4	1
Q 21	Q22	Q23	Q24	Q25	Q26	Q27	Q28		
4	2	3	1	4	3	2	4		

SECTION B

Q29)	<p>a) Yes, Jeremy's conclusion is correct. Both cell are plant cell and cell X is a root cell while cell Y is a leaf cell.</p> <p>b) Chloroplast. Chloroplast contain chlorophyll which helps to trap sunlight and make food for the plant.</p> <p>c) Part Z controls the movement in and out of the cell which prevent harmful substances from entering the cell.</p>
Q30)	<p>a) i) Plant Y's young are scattered further away, while plant X's young are scattered altogether causing them to fight for water and sunlight.</p> <p>ii) Fruit Q. Fruit Q's dispersing method is by splitting and plant X's young are near, thus it is fruit Q.</p> <p>b) Plants that disperse by water's seeding must have ended up there and plant Y's young must have grown up and the wind dispersed its seeds there.</p>

Q31)	<p>a) Fertilisation. Fertilisation happens when a sperm fuses with the egg making a fetus.</p> <p>b) During the process a lot of cell X would die to increase the chances of fertilising the egg there are many cell X.</p>		
Q32)	<p>The warmer water vapour from the surrounding corners into contact with the cooler surface of the plastic and condenses. The water droplets froze.</p>		
Q33)	<p>a) The bigger the exposed surface area is the rate of evaporation will be faster.</p> <p>b) If the temperature increases the rate of evaporation will increase to, to prevent that the three container were placed at the same place.</p> <p>c) The rate of evaporation increases when the temperature of water increases as water's boiling point is 100°C.</p>		
Q34)	<p>a) As the water-carrying tubes are present water is transported to leaf X to make food.</p> <p>b) The roots would not be able to receive the food, so the roots would die.</p>		
Q35)	<p>a) Nose, lungs and windpipe.</p> <p>b) A person requires more oxygen when running as more systems are working together.</p> <p>c) Carbon-dioxide</p>		
Q36)	<p>a) The number of bubbles produced decreased as the distance increase.</p> <p>b) There would not be an external source of light which would affect the results of the test.</p> <p>c) The least amount of light would reach Part B. The plants would produce the least amount of oxygen and the fish might die.</p>		
Q37)	<p>a) An electrical conductor allows electrical currents to flow through.</p> <p>b)</p> <table border="1" data-bbox="427 1704 754 1765"> <tr> <td>P, Q, R</td> <td>S, T</td> </tr> </table> <p>c) i) Z which was an electrical insulator was not letting the electrical current flow through, thus no bulbs lights up.</p>	P, Q, R	S, T
P, Q, R	S, T		

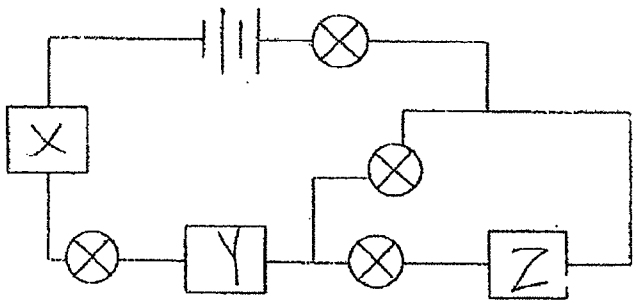
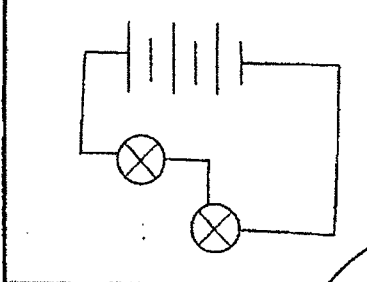
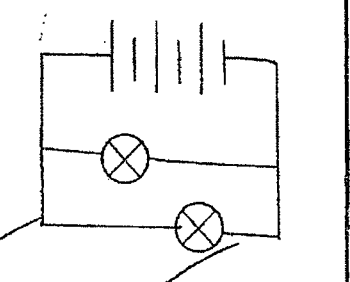
	<p>ii)</p> 			
Q38)	<p>a)</p> <div style="display: flex; justify-content: space-around;"> <div style="border: 1px solid black; padding: 5px; width: 45%;"> <p style="text-align: center; margin: 0;">Circuit C</p>  </div> <div style="border: 1px solid black; padding: 5px; width: 45%;"> <p style="text-align: center; margin: 0;">Circuit D</p>  </div> </div> <p>b) The brightness of the other bulb would increase.</p> <p>c) If one bulb fuses the other bulb would still be able to work.</p>			
Q39)	<p>a) The black container gains heat faster than the white container.</p> <p>b) The water evaporated into water vapour faster. Thus, more water vapour condensed into water droplets.</p>			
Q40)	<p>a)</p> <table border="1" style="margin-left: 20px;"> <tbody> <tr><td style="text-align: center;">✓</td></tr> <tr><td style="text-align: center;">✓</td></tr> <tr><td style="text-align: center;">✓</td></tr> </tbody> </table> <p>b) Graph Y shows that the temperature of water decrease faster than graph X. The bubbles wrap did not have air pockets and heat was lost faster.</p> <p>c) The air in the bubbles is poor conductor of heat. Thus, the heat from the oil is lost slowly to the ice cream.</p>	✓	✓	✓
✓				
✓				
✓				

