

Anglo-Chinese School (Junior)



BITE-SIZED ASSESSMENT 2 (2022)

PRIMARY 5

SCIENCE

Friday

6 May 2022

Name: _____ () Class: 5.() Parent's Signature: _____

INSTRUCTIONS TO PUPILS

- 1 Do not turn over the pages until you are told to do so.
- 2 Follow all instructions carefully.
- 3 There are 11 questions in this booklet.
- 4 Answer ALL questions.
- 5 The marks are given in the brackets [] at the end of each question or part question.

Question Paper	Possible Marks	Marks Obtained
Total	30	

This question paper consists of 11 printed pages (inclusive of cover page).

For questions 1 to 11, write your answers in this booklet.

The number of marks available is shown in brackets [] at the end of each question or part question.

(30 marks)

1. The diagram shows how substances are transported in the human body.

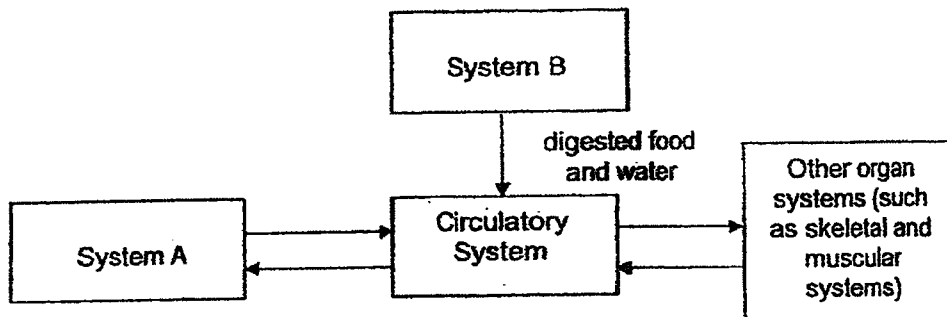

- (a) Name systems A and B. [1]

System A: _____

System B: _____

- (b) Name **two** substances that are transported in the blood away from other parts of the body for removal. [1]

- 2 (a) What is the function of the heart? [1]

- (b) Other than the heart, name two other parts of the circulatory system. [1]

(Go on to the next page)

SCORE	4
-------	---

3. The diagram shows the flow of blood in the human body. Letters J, K, L and M represent blood at different parts of the human body.

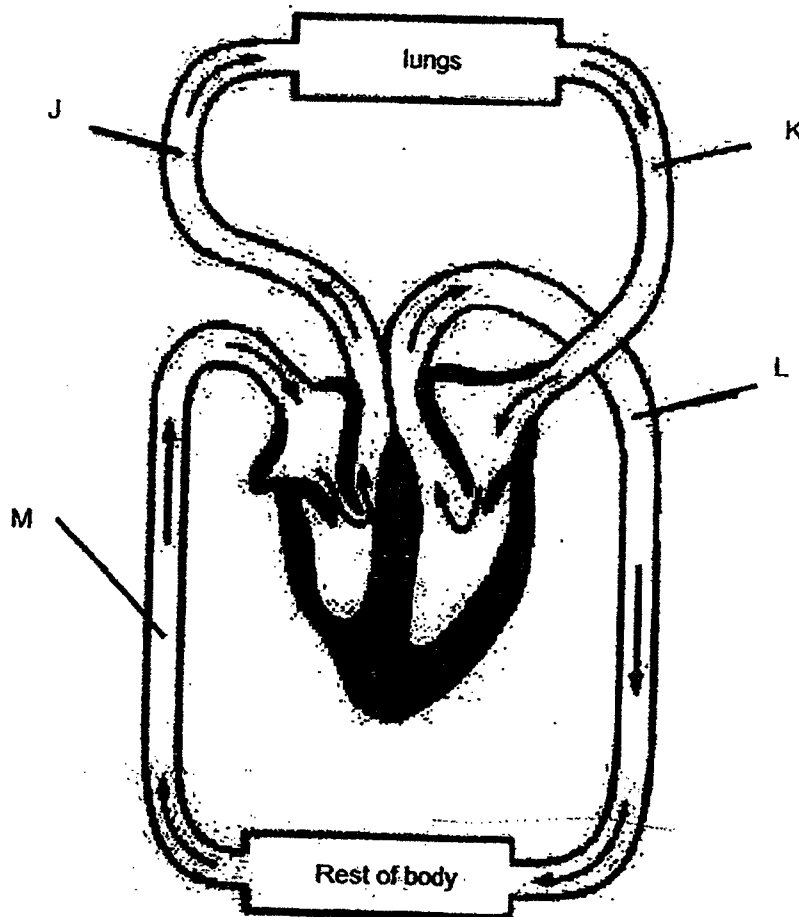

Classify which parts of the human body, J, K, L and M, is the blood rich in oxygen and carbon dioxide in the table.

[1]

Blood	
Rich in Oxygen	Rich in Carbon Dioxide

(Go on to the next page)

SCORE	1
-------	---

4. The graph shows Huishan's heart rate when she was exercising around the park.

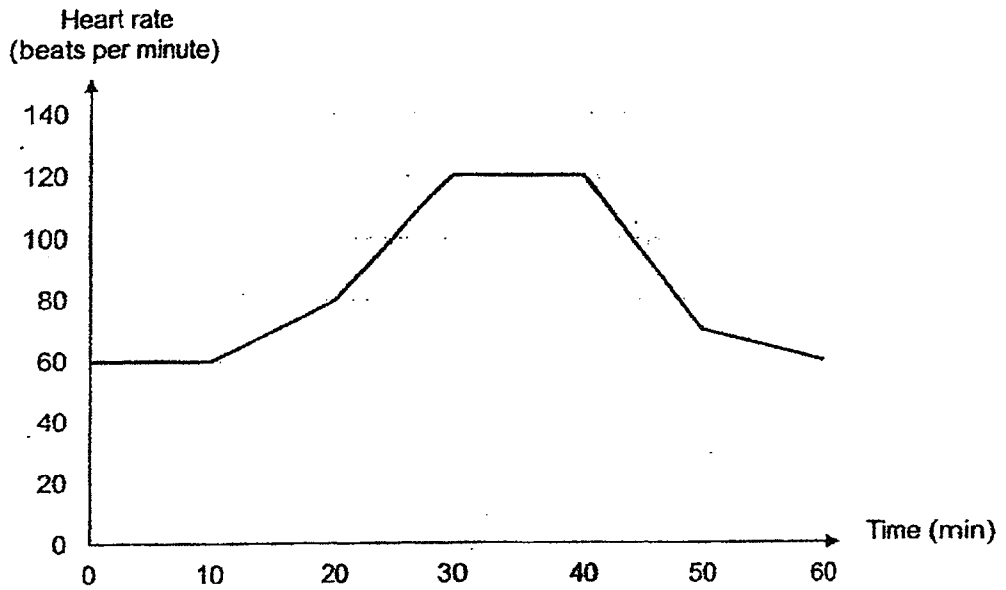

(a) What was Huishan's resting heart rate? [1]

(b) At which minute did Huishan start exercising? [1]

(c) Why did Huishan's heart rate increase when she was jogging? [2]

(Go on to the next page)

SCORE	4
-------	---

5

- 5(a) Jordan wanted to find out how the temperature of the surroundings affect the rate of evaporation of water.

He placed 50 ml of water each into three identical containers, A, B and C, and left them in three different rooms with different temperatures as shown.

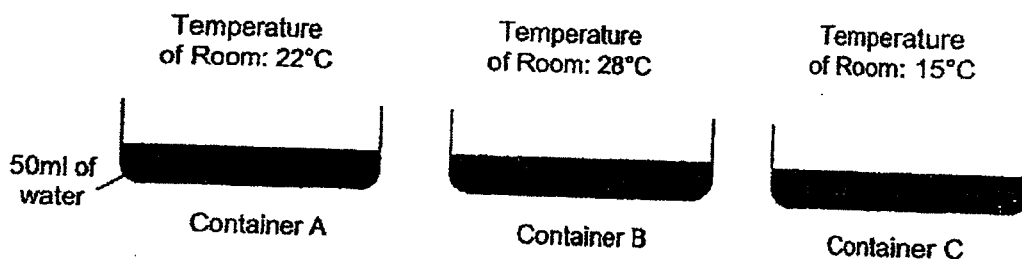

He measured the volume of water left in each container after three hours and observe that container C had the greatest volume of water left.

- (a)(i) Predict the volumes of water left in containers A and B by drawing the bars in the following graph. [1]

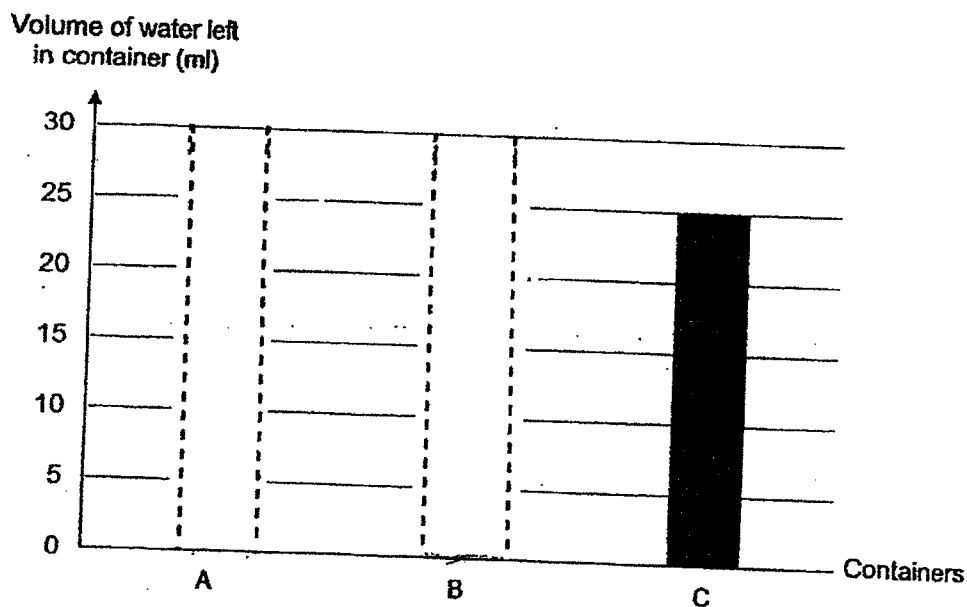



- (a)(ii) Give a reason why container C had the greatest volume of water left after three hours. [1]

(Go on to the next page)

SCORE	2
-------	---

- 5 (b)(i) After taking a shower, Jordan wanted to dry his wet towel as fast as possible.

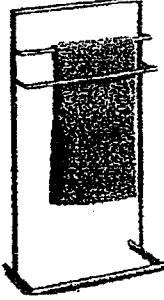
Which of the following should he do to ensure that his towel dries the fastest? Place a tick (✓) in the correct box. [1]

 <p>Leave his towel crumpled on the floor</p>	 <p>Hang his towel on a rack</p>	 <p>Fold his towel and place it in his cupboard</p>

- (b)(ii) Suggest another way that would help Jordan dry his towel faster. [1]

(Go on to the next page)

SCORE	2
-------	---

6. Mirabel took out substance X from the freezer and placed it into a beaker in an air-conditioned room. After one hour, she switched off the air-conditioner and left the beaker with substance X for another hour.

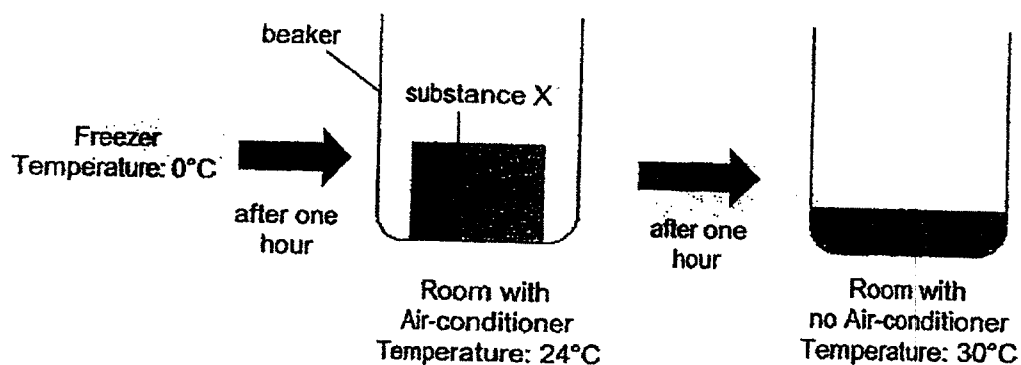

- (a) Why did substance X remain a solid after the first hour? [1]

- (b) Suggest a possible melting point for substance X. [1]

7. Jeremy measured and recorded the resting heart rate of four different people in the table.

Name	Age (years)	Resting Heart Rate (beats per minute)
Amirah	5	100
Bala	10	85
Charlene	25	60
Daniel	60	75

- What was the aim of Jeremy's experiment? [1]

(Go on to the next page)

SCORE	3
-------	---

8. Hassan wanted to collect water from sea water. He sets up an experiment as shown using plastic sheets of different temperatures.

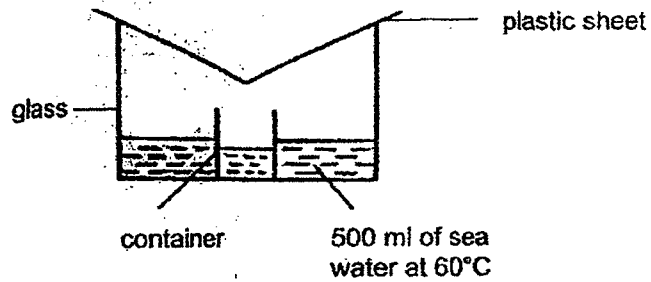

He measured and recorded the amount of water collected for each setup after fifteen minutes in the table.

Temperature of plastic sheet at the start of the experiment (°C)	Amount of water collected in the container (ml)
10	110
20	80
30	50

- (a) What is the relationship between the temperature of the plastic sheet and the amount of water collected? [1]

- (b) Would the amount of water collected be more or less if a metal sheet of 30°C was used instead of a plastic sheet at 30°C? [1]

- (c) Without adding more sea water and changing the plastic sheet, suggest what Hassan can do to the set-ups to collect more water in the same amount of time. [1]

(Go on to the next page)

SCORE	3
-------	---

9. Mrs Tan placed a freshly baked pizza into a cardboard box to have it delivered to her customer.

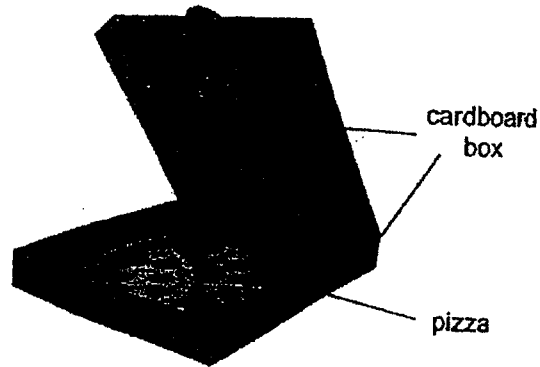

Upon receiving the pizza, her customer complained that the inner surface of the cardboard box and the pizza were wet

- (a) Explain why the inner surface of the cardboard box and the pizza were wet. [2]

Mrs Tan sent the same customer another pizza in a similar box with holes as shown.

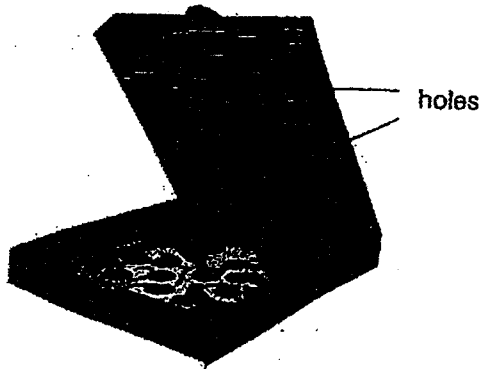

- (b) This time round, the pizza box was less wet. Explain why. [1]

(Go on to the next page)

SCORE	3
-------	---

10. The diagram represents the water cycle.

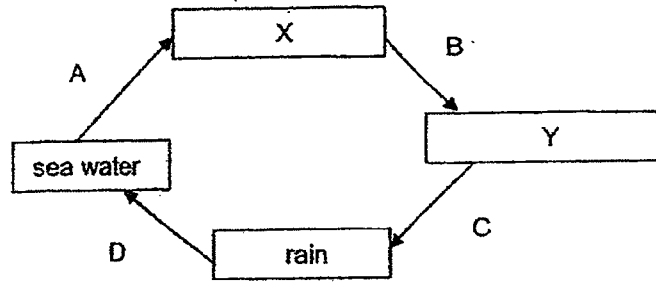

(a) What are X and Y? [1]

X: _____

Y: _____

(b) At which part(s), A, B, C or D, of the water cycle is there a change in the state of matter? [1]

(c) Many human activities have caused our water bodies to become polluted and unsuitable for use.

Which of the following human activities will result in water pollution? Place a tick(✓) in the correct box(es). [1]

Human Activities	Tick (✓)
Using rainwater to water plants.	
Throwing plastic bags into the sea.	
Removing harmful substances from used water through a cleaning process.	

(d) Water is a limited resource. Give an example of how we can reduce the use of water while washing dishes at home. [1]

(Go on to the next page)

SCORE	4
-------	---

11. Harris heated a beaker of water over a flame for some time. He then removed the flame. He also placed the beaker of water in the freezer. He recorded the changes in the temperature of the contents of the beaker in the graph.

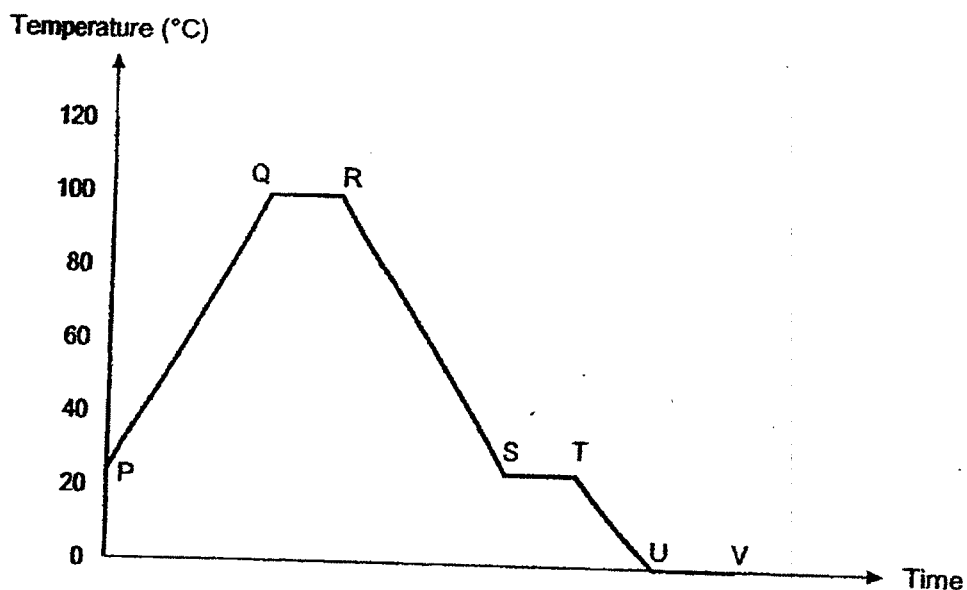

- (a) Name the process that is happening at QR.

[1]

- (b) Which of the following letters, P, Q, R, S, T, U or V, best represent when the flame was removed and when the beaker of water was placed into the freezer?

[1]

Flame was removed:	
Beaker of water was placed in the freezer:	

- (c) Based on the graph, which of the following statements are true? Write 'T' if the statement is true and 'F' if the statement is false.

[2]

Statements	T or F
Water is freezing at UV.	
Water is gaining heat at PQ only.	
Liquid is the only state of matter in the beaker at ST.	
Water does not evaporate throughout the experiment.	

End of Paper

SCORE	4
-------	---

Bite-Sized Assessment 2

Q1	(a) System A : Respiratory system System B : Digestive system (b) Carbon dioxide and waste materials	
Q2	(a) The function of the heart is to pump blood to all parts of the body . (b) Blood vessels and blood	
Q3	Rich in Oxygen	Rich in Carbon Dioxide
	K, L	J, M
Q4	(a) Her heart rate was 60 beats per minute. (b) She started exercising at the 10 th minute. (c) When a person exercises, the heart pumps blood faster so that more oxygen and digested food in the blood can be sent to all parts of the body to release more energy.	
Q5	 <p>(a)(i)</p> <p>(ii) C was placed in the room with the lowest temperature thus the rate of evaporation is the slowest, resulting in C having the greatest volume of water after three hours.</p> <p>(b) (i) Tick : Hang his towel on a rack (ii) He could put his towel near a fan.</p>	
Q6	(a) X's melting point was more than the room temperature of 24°C. (b) 25°C	
Q7	To find out if the age of a person affects the resting heart rate of a person.	
Q8	(a) As the temperature of the plastic sheet increases, the amount of water collected in the container decreases. (b) The amount of water collected would be more if a metal sheet of 30°C was used. (c) Hassan could heat up the seawater.	
Q9	(a) The water from the pizza gained heat and evaporated to form water vapour which lost heat to and condensed on the cooler surface of the box into water droplets.	

	(b) The holes in the pizza box allowed the water vapour in the box to escape, hence the pizza box was less wet.					
Q10	(a) X : water vapour Y : clouds (b) Parts A and B (c) Tick : Throwing plastic bags into the sea. (d) We can wash the dishes in a basin.					
Q11	(a) Boiling (b) <table border="1" data-bbox="363 667 1134 801"> <tr> <td>Flame was removed :</td> <td>R</td> </tr> <tr> <td>Beaker of water was placed in the freezer :</td> <td>T</td> </tr> </table>		Flame was removed :	R	Beaker of water was placed in the freezer :	T
Flame was removed :	R					
Beaker of water was placed in the freezer :	T					
	(c) T, F, F, F					