



MAHA BODHI SCHOOL  
2023 END OF YEAR EXAMINATION  
PRIMARY FIVE SCIENCE  
(BOOKLET A)

Name : \_\_\_\_\_ (     )

Class : Primary 5 \_\_\_\_\_

Date : 26 Oct 2023

Total Duration for Booklets A and B: 1 h 45 min

---

**INSTRUCTIONS TO CANDIDATES:**

1. Do not turn over this page until you are told to do so.
2. Follow all instructions carefully.
3. Answer all questions.
4. Shade your answers in the Optical Answer Sheet (OAS) provided.

This booklet consists of 16 printed pages.

**BLANK PAGE**

**BOOKLET A : [28 x 2 marks = 56 marks]**

For each question from 1 to 28, four options are given. One of them is the correct answer. Make your choice (1, 2, 3 or 4). Shade your answer on the Optical Answer Sheet.

---

1. The diagram below shows a leaf cell.

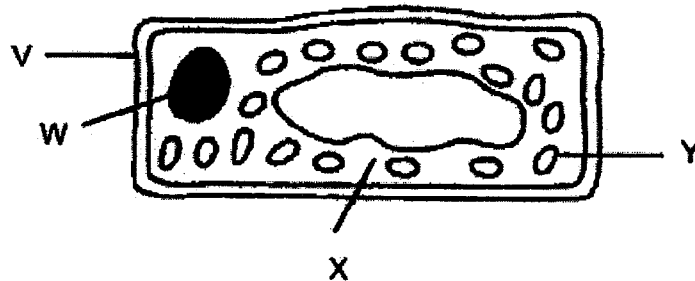

Which parts of the leaf cell are not found in animal cells?

- (1) V and W only
  - (2) V and Y only
  - (3) X and Y only
  - (4) W, X and Y only
2. Which of the following helps to give a cell its regular shape?

- (1) nucleus
- (2) cell wall
- (3) cytoplasm
- (4) cell membrane

3. Study the statements made by four pupils below.

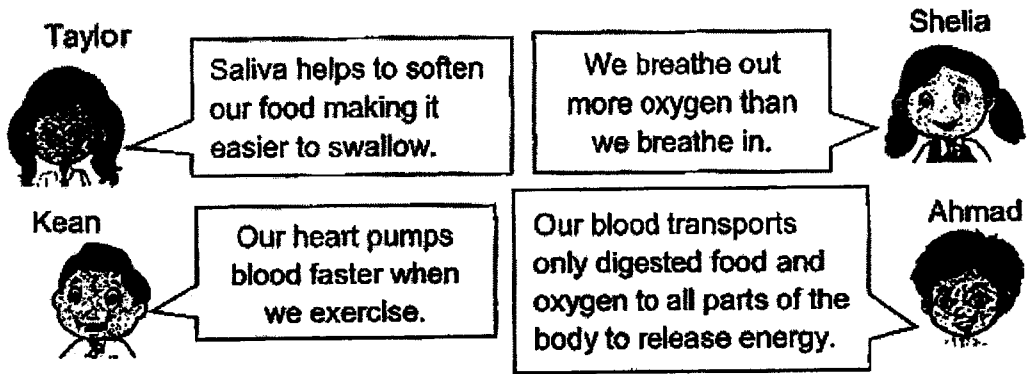

Which pupils were correct?

- (1) Ahmad and Shelia only
- (2) Kean and Taylor only
- (3) Ahmad, Kean and Shelia only
- (4) Kean, Shelia and Taylor only

4. The diagram below shows various paths taken by food and the different gases in the human body.

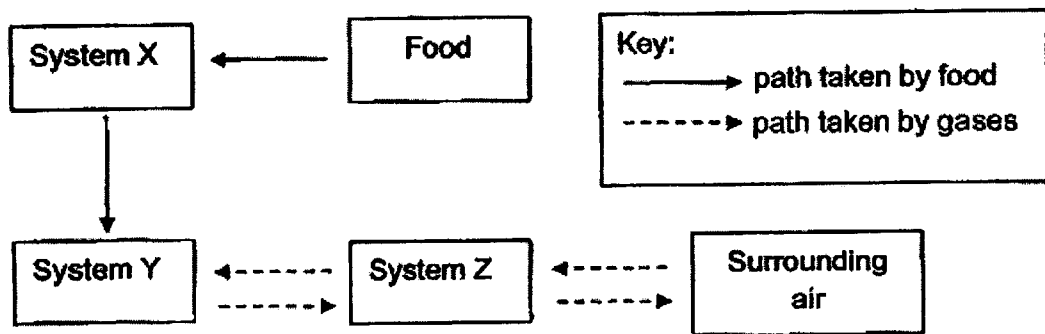

Which systems do X, Y and Z represent?

	X	Y	Z
(1)	Circulatory	Digestive	Respiratory
(2)	Digestive	Respiratory	Circulatory
(3)	Digestive	Circulatory	Respiratory
(4)	Respiratory	Circulatory	Digestive

5. The diagram below shows a plant.

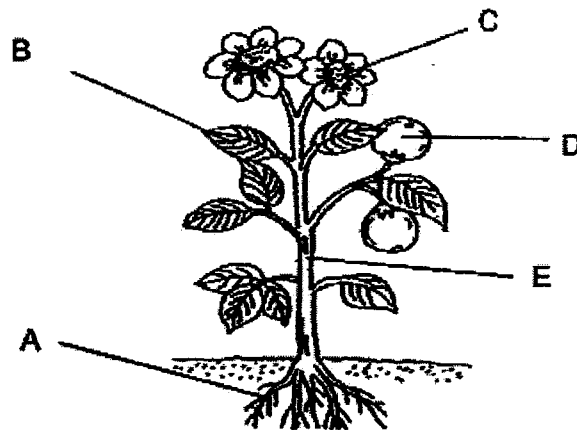

Based on the diagram, at which part(s) of the plant can food-carrying tubes be found?

- (1) B only
  - (2) B and E only
  - (3) B, D and E only
  - (4) A, B, C, D and E
6. The diagram below shows the cross section of a flower.

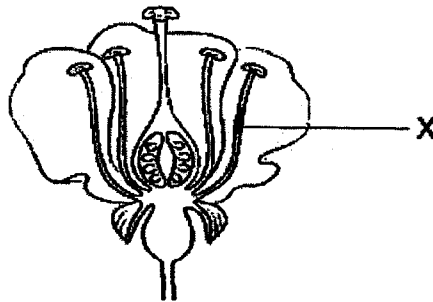

What is the flower part labeled X?

- (1) petals
- (2) anther
- (3) stigma
- (4) filament

7. In which of the following human reproductive parts is the egg produced?

- (1) womb
- (2) ovary
- (3) penis
- (4) testes

8. Which of the following characteristics are not passed down from parents to their young?

- A. length of hair
- B. type of eyelid
- C. type of earlobe
- D. length of fingernail

- (1) A and D only
- (2) B and C only
- (3) B, C and D only
- (4) A, B, C and D

9. Study the classification table below.

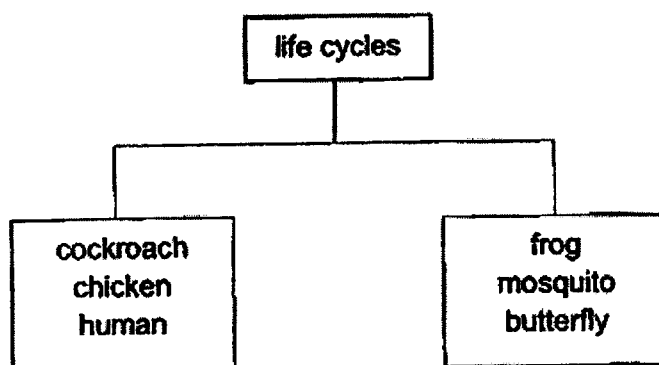

How are the animals being classified?

- (1) Based on whether they have a pupa stage.
- (2) Based on the number of stages in the life cycle.
- (3) Based on whether the young looks like the adult.
- (4) Based on whether the eggs are laid in water or on land.

10. The table below shows the parts of cell X and Y.

Parts of cell	Cell X	Cell Y
Nucleus	✓	✓
Chloroplast	x	x
Cell wall	✓	x
Cell membrane	✓	✓
Cytoplasm	✓	✓

Which of the following statements about cells X and Y are true?

	Cell X	Cell Y
(1)	It can reproduce by itself.	It is a cheek cell.
(2)	It is taken from a flower.	It is not a reproductive cell.
(3)	It can make food.	It is an animal cell.
(4)	It is taken from a rose plant.	It can make food.

11. The following shows the life cycle of a plant.

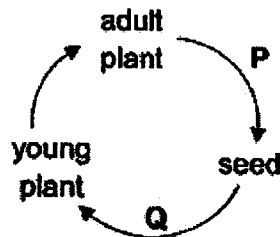

What are processes P and Q?

	P	Q
(1)	germination	dispersal
(2)	dispersal	germination
(3)	fertilisation	pollination
(4)	fertilisation	germination

12. The diagram shows the stages in the life cycle of an insect.

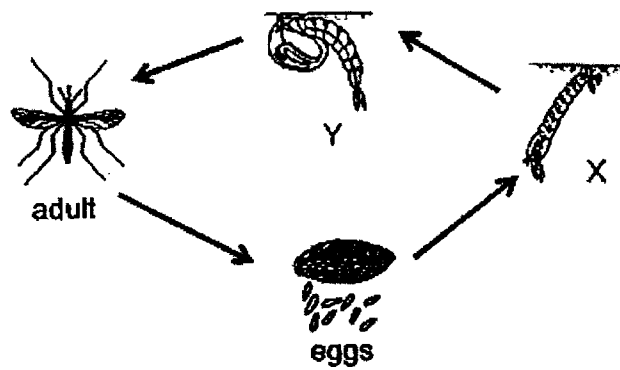

Which of the following is true about stages X and Y?

- A. X can fly.
  - B. Y does not moult.
  - C. X and Y live in water.
  - D. X and Y do not eat and move.
- (1) A and D only  
(2) B and C only  
(3) A, B and C only  
(4) B, C and D only



13. Melinda sets up an experiment using four similar leaves, P, Q, R and S of the same plant. These leaves have tiny openings known as stomata on their upper and lower surfaces.

She coated some surfaces of the leaves with oil as shown in diagram below.

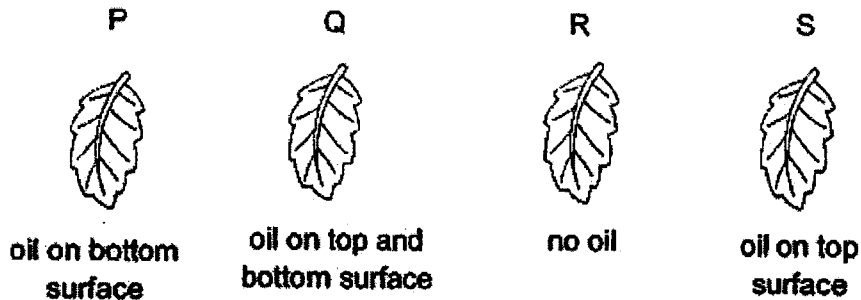

The leaves are hung and placed under bright sunlight in the garden for 2 hours. Melinda measures the mass of the leaves at regular time intervals. Leaves lose water through the stomata. The results are shown in the bar graph below.

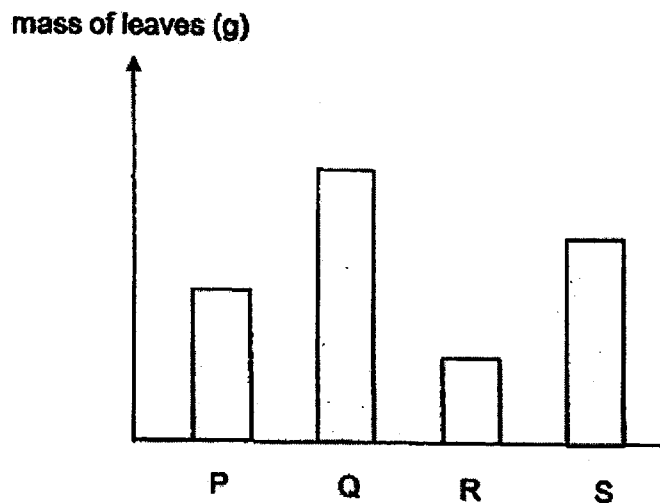

Based on the results, what can Melinda conclude about the stomata on the leaves of this plant?

- (1) More water is lost through the stomata in leaves P than Q.
- (2) There are fewer stomata found on the upper surface of the leaves.
- (3) The stomata on the lower surface of the leaves are bigger than those on the upper surface.
- (4) Leaf R lost the most amount of water because it has more stomata on the lower surface of the leaf.

14. Susan wants to find out if light is needed for the germination of seeds. She used the following set-ups for her experiment.

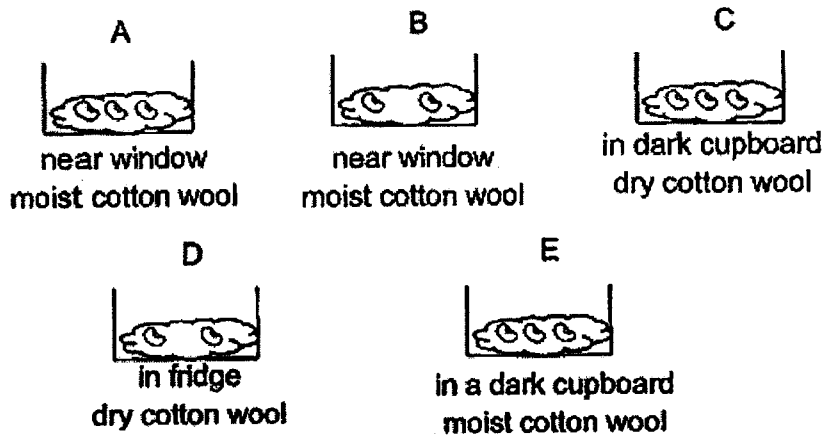

Which 2 set-ups should she use for a fair test?

- (1) A and E
  - (2) A and B
  - (3) B and D
  - (4) C and D
15. A pupil made a puppet using pieces of wood and some strings as shown below.

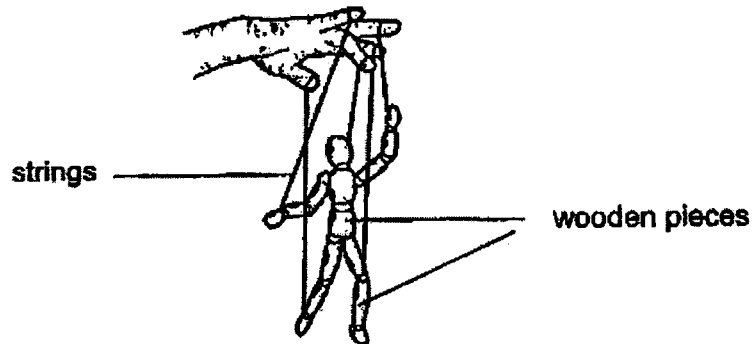

The puppet moves when the strings are pulled.  
What body system do the wooden pieces and string represent?

	strings	wooden pieces
(1)	Circulatory	Skeletal
(2)	Muscular	Digestive
(3)	Muscular	Skeletal
(4)	Respiratory	Muscular

16. The diagram below shows the changes in the states of water.

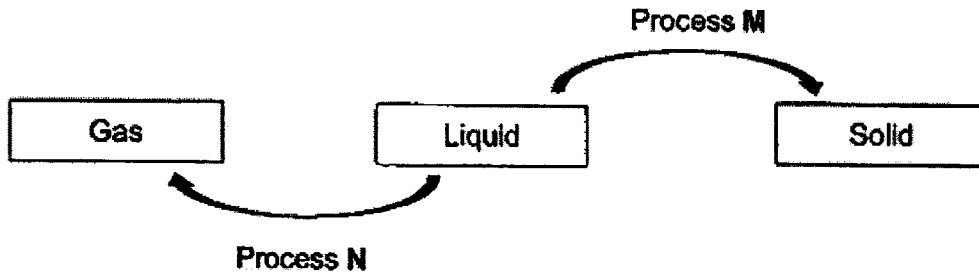

Which of the following is correct?

	Process M	Process N
(1)	Melting	Freezing
(2)	Freezing	Boiling
(3)	Freezing	Melting
(4)	Condensation	Evaporation

17. A pot of water is heated on a stove.

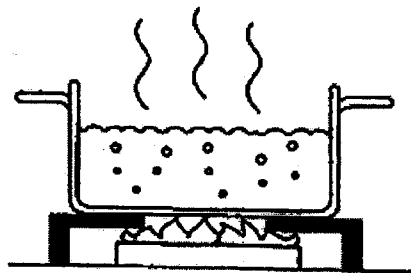

Which of the following statements are correct when the water starts to boil?

- A. There are bubbles as the water boils.
- B. The temperature of water stops increasing.
- C. The water in the pot gains heat faster from the flame.
- D. The temperature of water increases more slowly than before.

- (1) A and B only
- (2) A and D only
- (3) B and C only
- (4) B and D only

18. Thomas set up 4 different circuits.

In which of the following circuits will the bulb light up?

(1)

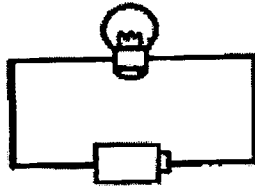

(2)

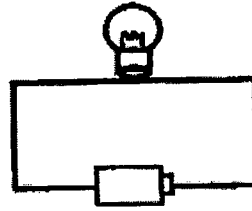

(3)

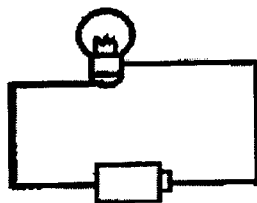

(4)

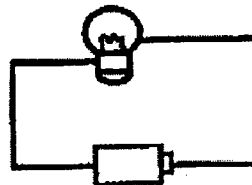

19. Sally found a magnet and wants to find out the poles of the magnet. She placed a compass near one pole of the magnet and observed the following.

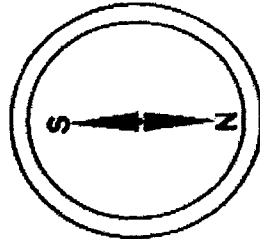

compass



magnet

What could P and Q possibly be?

	P	Q
(1)	north-pole	south-pole
(2)	south-pole	north-pole
(3)	north-pole	north-pole
(4)	south-pole	south-pole

20. The graph below shows the change in temperature of Substance P as it was heated for 50 minutes. Before heating, Substance P was a solid.

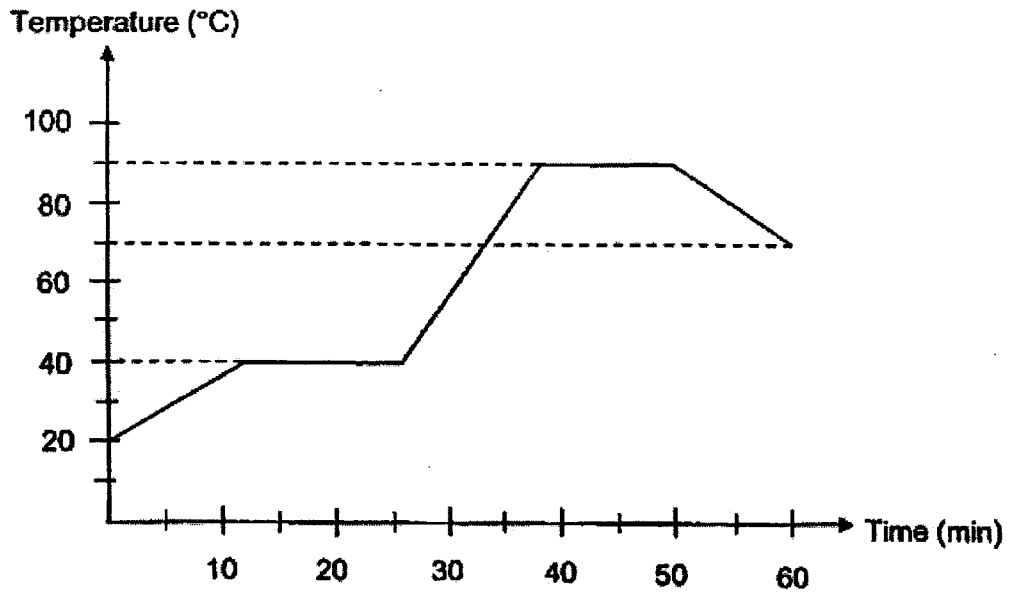

Which of the following correctly represents the melting point and boiling point of substance P?

	Melting point (°C)	Boiling point (°C)
(1)	0	100
(2)	20	70
(3)	40	90
(4)	40	70

21. Shanti poured equal volume of water into four containers which were made of the same material. The containers were left on the table in the Science Laboratory.

Which one of the containers would have the most amount of water left after a day?

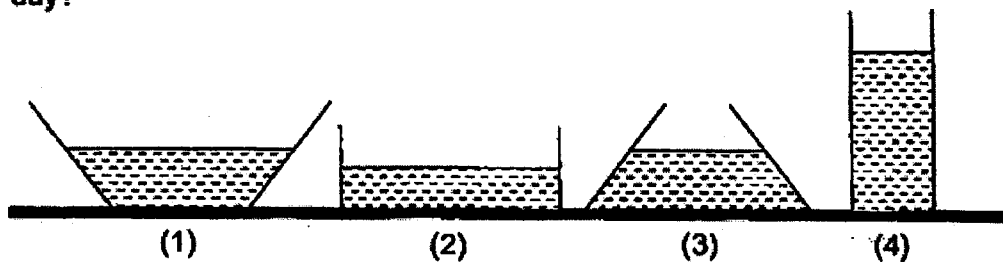

22. Kumar set up a circuit as shown below. He placed materials A, B and C in positions W, X and Y in the circuit. All electrical components are working properly.

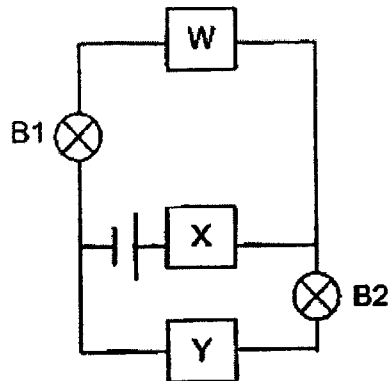

He recorded his observations below.

W	X	Y	Bulbs Lit
A	B	C	B1
C	A	B	B2

Based on his observations, what could materials A, B and C be?

	A	B	C
(1)	steel	iron	copper
(2)	wood	steel	copper
(3)	plastic	wood	steel
(4)	copper	iron	rubber

23. Study the circuit below.

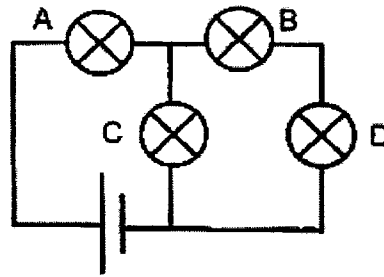

One bulb fused and three other bulbs remain lit.

Which bulb is fused?

- (1) A
- (2) B
- (3) C
- (4) D

24. Samy has  $120 \text{ cm}^3$  of oxygen in a tank. He wants to transfer all the oxygen in the tank into a container.

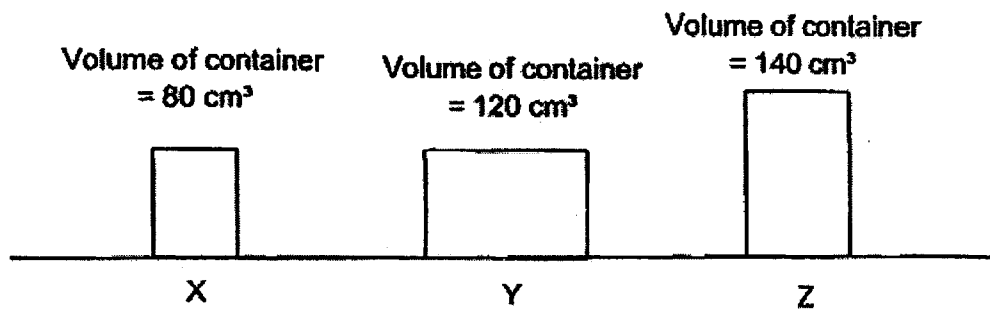

Which of the following would be able to hold all the oxygen?

- (1) Y only
- (2) Z only
- (3) Y and Z only
- (4) X, Y and Z

25. The diagrams below three objects, A, B and C made from different materials, X, Y and Z. The objects are of the same height and width.

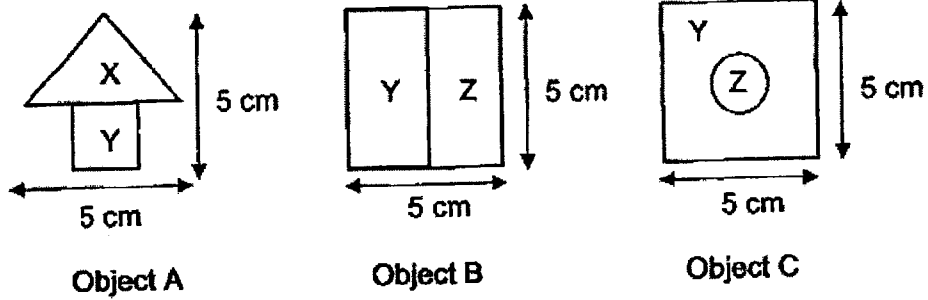

The three objects were arranged between a light source and a screen as shown below.

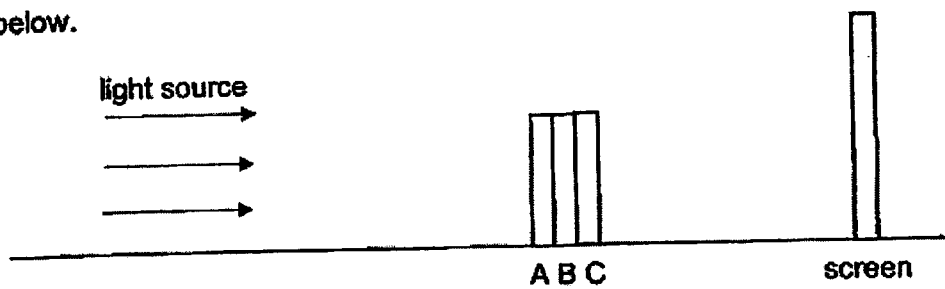

The diagram below shows the shadow captured on the screen.



Which of the following are materials X, Y and Z made of?

	X	Y	Z
(1)	clear glass	clear plastic	rubber
(2)	wood	metal	rubber
(3)	clear plastic	wood	ceramic
(4)	metal	clear glass	wood



26. The diagram below shows the side view of a cup noodle container that cooks noodles by pouring hot water inside and covering it with the lid.

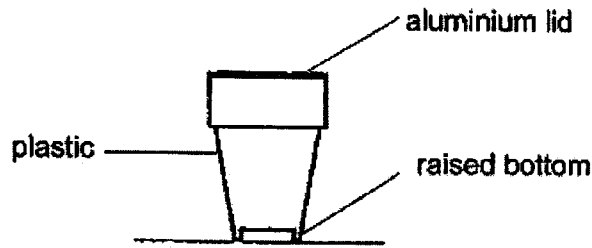

Which of the following explain(s) how the parts of the container help the noodles inside stay warm longer?

- A. The raised bottom traps air.
- B. The plastic is a poor conductor of heat.
- C. The aluminium lid is a good conductor of heat.
- D. The raised bottom reduces the surface area in contact with the table.

- (1) B only
- (2) A and C only
- (3) A, B and D only
- (4) A, B, C and D

27. Four identical blocks, A, B, C and D were at different temperatures. The diagrams below show the direction of heat flow if they were placed side by side.



Which of the following shows the possible temperatures of the blocks?

Temperature of blocks (°C)				
	A	B	C	D
(1)	110	90	70	50
(2)	90	50	110	70
(3)	50	110	70	90
(4)	70	50	90	110

28. Workers at construction sites and fishmongers at wet market wear boots. The boots are made from different materials.



boots X worn at  
construction site



boots Y worn at  
wet market

Which are the properties the boots, X and Y, must have for the different workers?

	Boots X	Boots Y
(1)	strong	transparent
(2)	waterproof	allow some light to pass through
(3)	ability to float	waterproof
(4)	strong	waterproof

**END OF BOOKLET A**

**GO ON TO BOOKLET B**



MAHA BODHI SCHOOL  
2023 END OF YEAR EXAMINATION  
PRIMARY FIVE SCIENCE  
(BOOKLET B)

Name: \_\_\_\_\_ (      )

Class: Primary 5 \_\_\_\_\_

Date : 26 Oct 2023

Total Duration for Booklets A and B: 1 h 45 min

---

**INSTRUCTIONS TO CANDIDATES:**

1. Do not turn over this page until you are told to do so.
2. Follow all instructions carefully.
3. Answer all questions.
4. Write all your answer in this booklet.

Booklet	Marks Obtained	Max Marks
A		56
B		44
Total		100

Parent's signature: \_\_\_\_\_

This booklet consists of 15 printed pages.

**BLANK PAGE**

**BOOKLET B : [44 marks]**

For questions 29 to 40, write your answers in this booklet.

The number of marks available is shown in the brackets [ ] at the end of each question or part-question.

---

29. (a) Wei Liang put a plant with white flowers into a beaker of blue-coloured water. He removed an outer ring from the stem of the plant as shown below.

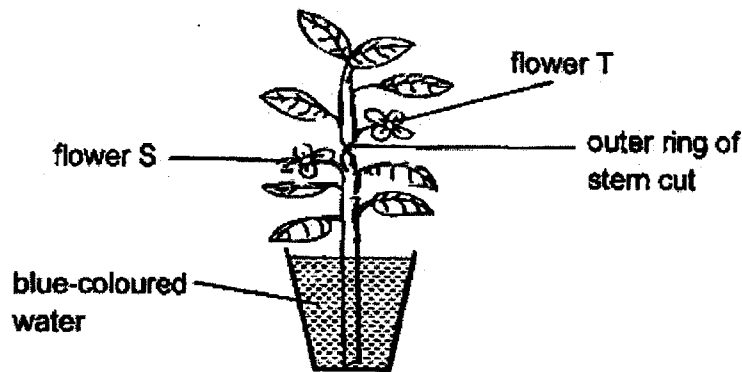

- (i) Explain why after a day, there was no change in the colour of flower T? [1]

---

---

- (ii) The leaves and flower above the cut wilt and die but the part below the cut continue to grow well. Explain why the part below the cut continue to grow well? [1]

---

---

Marks : 

/ 2
-----

29. (b) The diagram below shows the human digestive system.

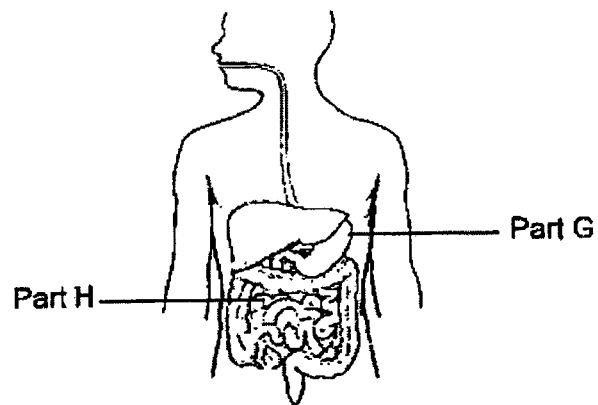

(i) Identify the parts G and H of the digestive system. [1]

Part G : \_\_\_\_\_

Part H : \_\_\_\_\_

(ii) Explain how the teeth help in the digestion of food. [1]

---

---

Marks : 

/ 2
-----

30. Xavier and Yenni exercised for 1 minute. Their heart rates were recorded before and after exercising in the graph below.

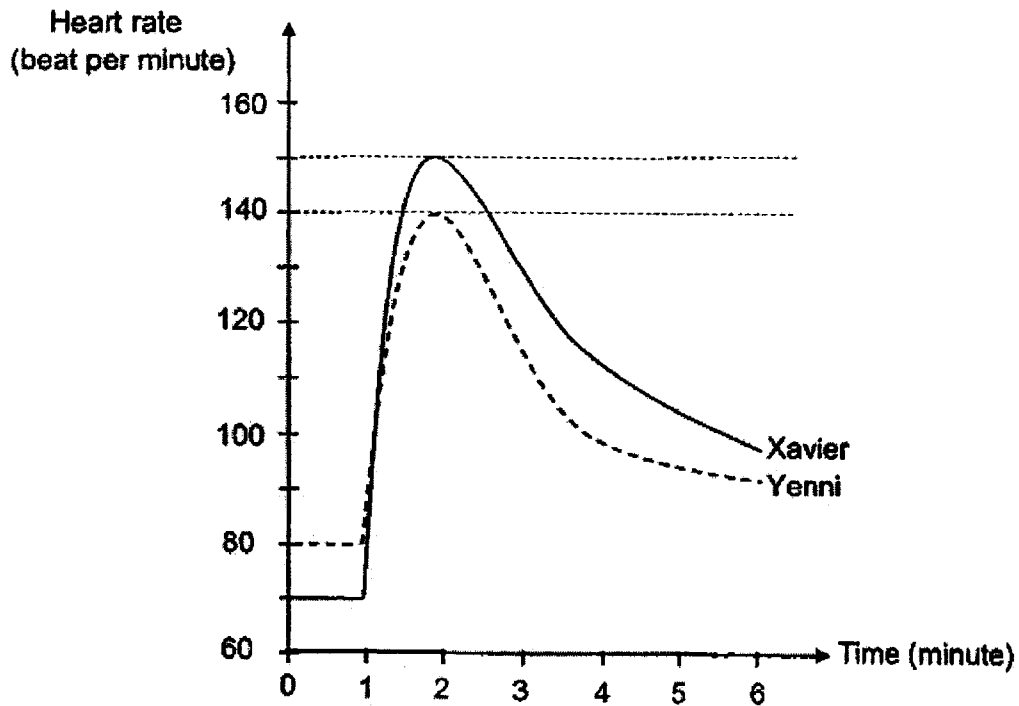

- (a) What is Yenni's heart rate after 1 minute of exercising? [1]

---

- (b) What is Xavier's heart rate at rest? [1]

---

- (c) Based on the graph, explain how both Xavier's and Yenni's heart rates change from the 1<sup>st</sup> to the 6<sup>th</sup> minute. [2]

---



---



---



---

Marks :  / 4

31. Frankie wanted to find out how the mass of a seed affects the distance it travels. He released three seeds X, Y and Z which have the same wingspan but of different mass from the same height. He measured the distance travelled by each seed and recorded the results in the table below.

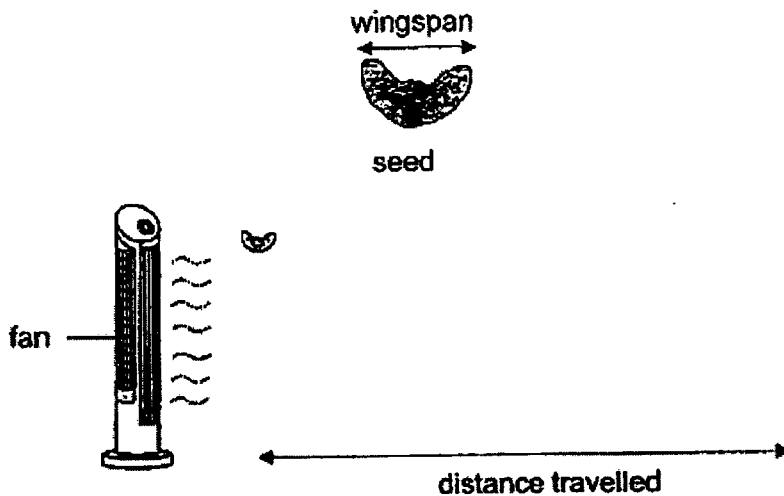

Seed	Mass of seed (g)	Distance travelled (m)
X	5	5
Y	12	3
Z	25	2

- (a) Based on his results, what is the relationship between the mass of the seed and the distance travelled? [1]

---



---

- (b) Based on the results, which seed X, Y or Z would most likely grow into the healthiest plant? Explain your answer. [2]

---



---



---

Marks : / 3



32. The diagram below shows a flower.

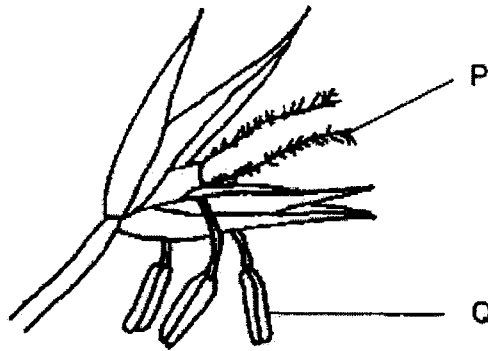

- (a) Based on the diagram, explain how the characteristic of part P of the flower helps it to be pollinated. [1]

---

---

- (b) Some parts of the flower were removed. However, it was observed that a fruit developed after a few days. Explain why. [2]

---

---

---

Marks : 

/ 3
-----

33. Linda crushed some ice blocks and put the crushed ice into a beaker. She left the beaker of crushed ice on a table as shown below.

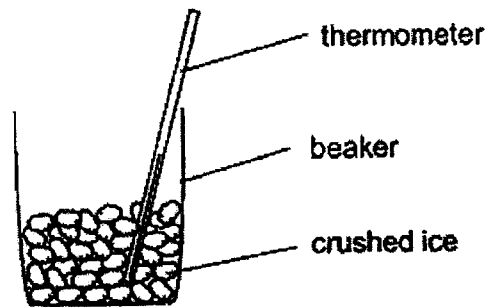

She recorded the temperature of the crushed ice every 2 minutes. The results of the experiment are recorded below.

Time (min)	Temperature ( $^{\circ}\text{C}$ )
0	0
2	0
4	0
6	2
8	4
10	6

- (a) What is the temperature change from 4 minutes onwards? [1]

---

- (b) Based on the results, explain why there was no increase in the temperature of the crushed ice during the first 4 minutes of the experiment? [1]

---

---

- (c) If she did not crush the ice blocks, will it take a shorter, longer or the same time for the temperature to start increasing? Explain your answer. [2]

---

---

---

Marks :

14

34. Jonas has three steel rings P, Q and R of the same size. He arranged the rings on a holder. His observations are shown below.

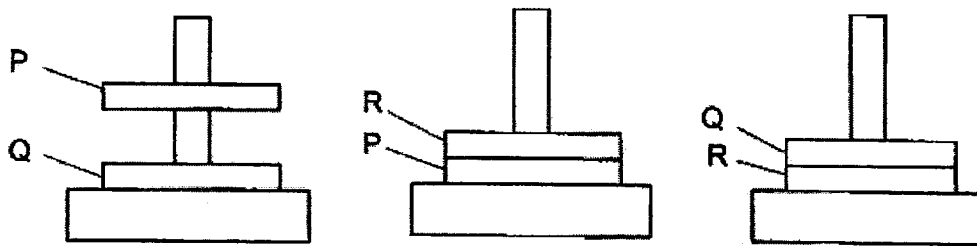

- (a) Based on his observations, state what rings P and Q are? [1]

---

- (b) Jonas concluded that R is a magnet. Do you agree? Explain why. [1]

---

---

Marks :

12

35. Study the table below carefully.

Set-ups	Temperature of water in the container (°C)	Amount of water (ml)	Exposed surface area of water (cm <sup>2</sup> )
A	60	120	35
B	28	120	20
C	28	100	20
D	70	100	35

(a) If Sabrina wants to find out how the amount of water affects the rate of evaporation, which two set-ups should she use to conduct a fair test? [1]

---

(b) From the table, which set-up, A, B, C or D, will have the highest rate of evaporation of water? Explain your answer. [1]

---

---

(c) In a reservoir, there are floating black balls covering the reservoir's surface.

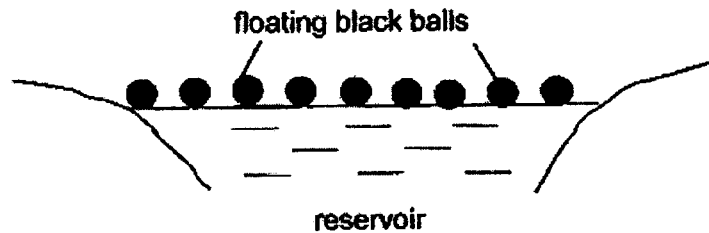

Explain how the floating black balls help to reduce water loss from the reservoir during long periods of hot weather. [1]

---

---

---

Marks :

13

35. (d) Many tall trees were planted along the reservoir as shown in the diagram below.

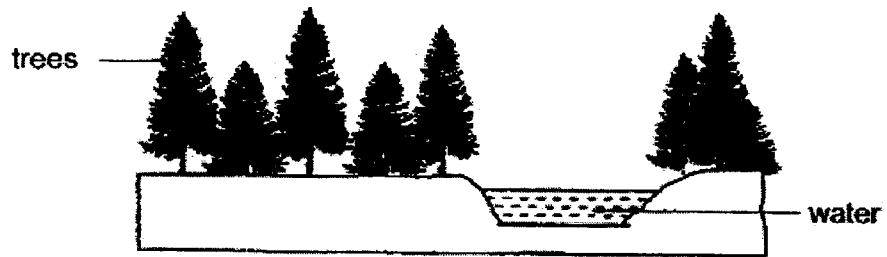

Explain how the presence of the trees help to reduce water loss from the reservoir. [1]

---

---

Marks : 

/ 1
-----

36. Ethan set up a circuit as shown below.

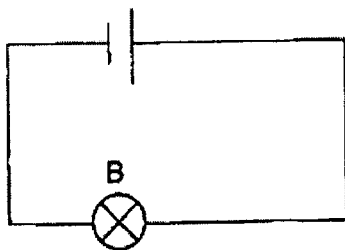

- (a) In the diagram above, **DRAW** another bulb X and wire without affecting the brightness of the bulb B. Both bulbs B and X must be lit. [1]
- (b) He setup a circuit as below. The pivot allows the iron bar to swing up and down. When the switch is closed, the light turns on and off repeatedly.

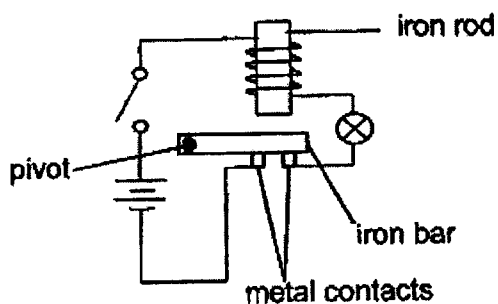

- (i) Explain why the light turns on and off repeatedly. [2]

---



---



---

- (ii) He replaced the iron bar with an aluminium bar. He observed that the bulb remained lit instead of turning on and off repeatedly. Explain why. [2]

---



---



---

Marks : 

/ 5
-----

37. Belinda had  $100 \text{ cm}^3$  of dry sand in a measuring cylinder and  $50 \text{ cm}^3$  of water in a beaker as shown below. She poured the water slowly into the measuring cylinder without spilling.

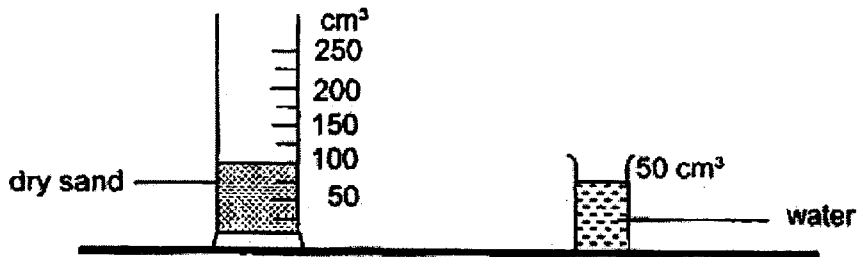

- (a) What would be the total volume of sand and water? Put a tick ( $\checkmark$ ) in the correct box and explain your answer. [1]

$100 \text{ cm}^3$	
More than $100 \text{ cm}^3$ but less than $150 \text{ cm}^3$	
$150 \text{ cm}^3$	

---



---

- (b) Belinda dried the sand and poured the sand into a  $500 \text{ cm}^3$  container. She used a cover fixed with a pipe to seal the container as shown below.

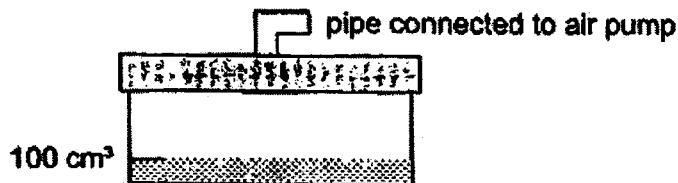

- She then pumped in  $50 \text{ cm}^3$  of air into the container through the pipe. What is the volume of air in the container? Explain your answer. [2]

---



---

Marks : 

/ 3
-----

38. In the set-up below, a lamp is at the center of the room and a boy ran from point A to point C.

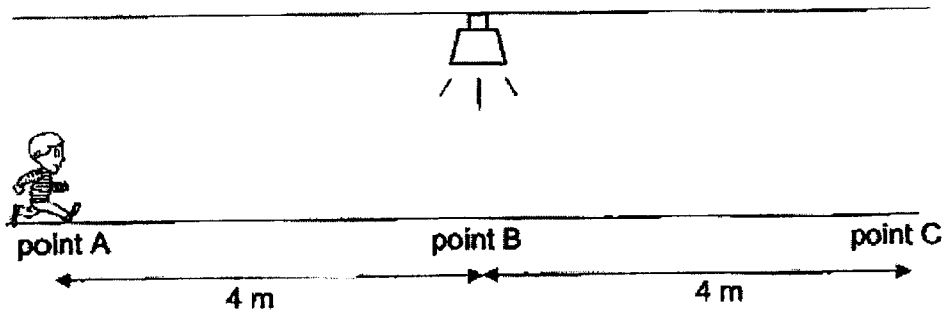

The graph below shows the length of the shadow of the boy as the boy moves from point A to point B, directly under the lamp.

length of shadow (units)

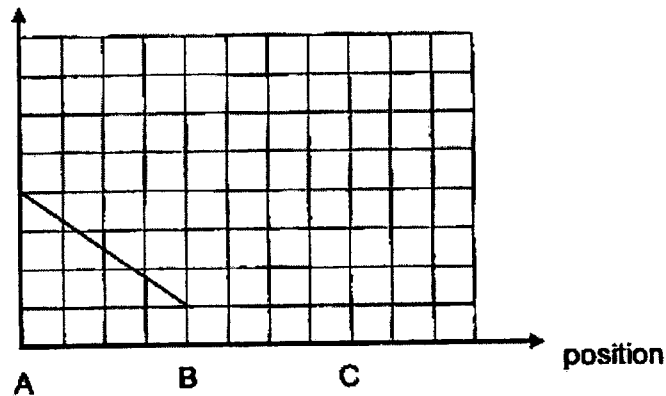

- (a) Explain how the shadow of the boy is formed on the ground. [1]

---



---

- (b) Draw in the graph above to show the length of the shadow of the boy from position B to C. [1]

- (c) Explain your answer in (b). [1]

---



---

Marks : / 3



39. In the experiment below, a weight of 1 kg was placed on material X and the distance material X was bent was recorded.

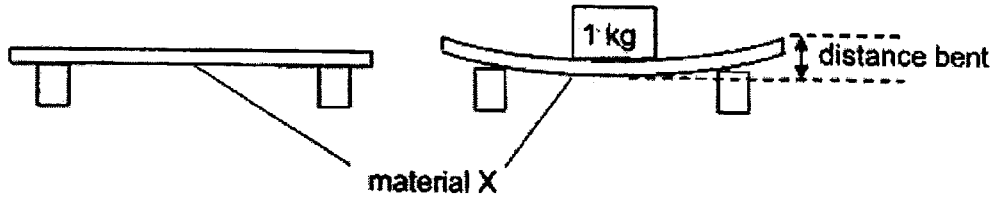

The experiment was repeated with material Y and the results is shown in the table below.

Material	Distance the material was bent (cm)
X	5
Y	10

- (a) What is the property of the materials that was tested? [1]

---

- (b) Based on the results, which material, X or Y, is more suitable for making food trays to be used at a hawker center? Explain your answer. [2]

---

---

---

- (c) What change should be made to the experiment to find out which material is stronger? [1]

---

---

Marks : 

/ 4
-----

40. The diagram below shows a glass thermometer filled with liquid P.

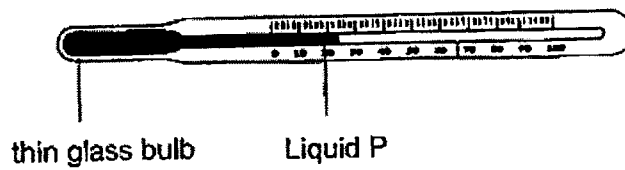

- (a) Explain how liquid P helps to measure temperature of a beaker of hot water. [1]

---

---

- (b) John thinks that a thermometer with the thin glass bulb may break easily so he used a similar thermometer but with a thicker glass bulb.



- How will the time taken for a temperature reading be affected? Explain your answer. [2]

---

---

---

Marks :  / 3

40. (c) The graph below shows the changes in volume of some liquids as the temperature increases.

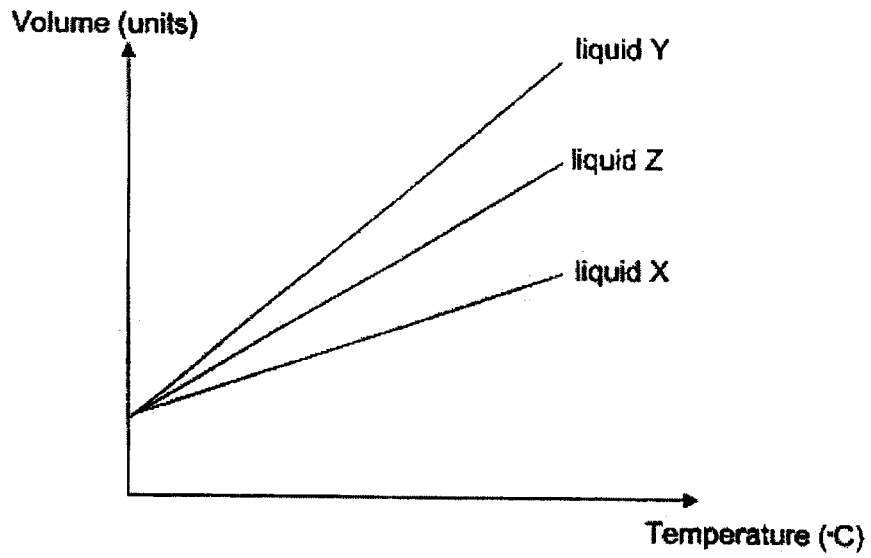

Based on the graph, which of the liquids will be best to use for measuring small changes in the temperature? Explain your answer. [2]

---

---

---

Marks :

12

~ END OF PAPER ~



**SCHOOL : MAHA BODHI PRIMARY SCHOOL**  
**LEVEL : PRIMARY 5**  
**SUBJECT : SCIENCE**  
**TERM : SA2 (2023)**

**CONTACT :**

Q 1	Q2	Q3	Q4	Q5	Q6	Q7	Q8	Q9	Q10
2	2	2	3	4	4	2	1	3	1
Q 11	Q12	Q13	Q14	Q15	Q16	Q17	Q18	Q19	Q20
4	2	1	1	3	2	1	3	2	3
Q 21	Q22	Q23	Q24	Q25	Q26	Q27	Q28		
4	4	3	4	4	3	4	4		

Q29)	<p>a)i)When the outer ring of the plant is removed, the water-carrying tubes are also removed . Hence, the blue-coloured water will not be able to be transported the flower T, causing it to remain white.</p> <p>ii)The part below the cut will be able to have food and water as there is still leaves to make food and since the water-carrying tubes are not removed, the plant will still be able to transport and receiver water, allowing it to grown well.</p> <p>b)i)Part G: stomach Part H: small intestine</p> <p>ii)Teeth helps to break the food to smaller pieces. So that there will be more (exposed) surface area for the digestive juices to act on.</p>
Q30)	<p>a)140 beats per minute</p> <p>b)70 beats per minute</p>

	<p>c) Xavier and Yenni's heart rate increased from the 1<sup>st</sup> to 2<sup>nd</sup> minute, as when they exercise they need more energy and their body needs more oxygen and digested food that is carried in their blood, causing their heart to pump faster. Their heart rate decreased from the 2<sup>nd</sup> to 6<sup>th</sup> minute as they started to rest, which takes up lesser energy. Hence, their heart will pump lesser oxygen and digested food to their body, causing their heart rate to decrease.</p>
Q31)	<p>a) The lighter the mass of the seed, the further the distance travelled by it.</p> <p>b) X as it was dispersed the furthest away from the parent plant and it would have the least competition for light, water, minerals and space.</p>
Q32)	<p>a) When the wind blows, the pollen grains from anther will be carried away by the wind and since part P is feathery, pollen grains will get caught in it, and the flower will be pollinated.</p> <p>b) The flower still had its stigma so it can still be pollinated. The flower still has its ovaries so fertilisation can take place.</p>
Q33)	<p>a) The temperature of the ice increased.</p> <p>b) The crushed ice was melting and when it melts, it gains heat but the temperature stays the same.</p> <p>c) It will take a long time as when the ice is crushed, it has a larger exposed surface area to when it is not crushed, allowing it to gain heat and melt faster.</p>
Q34)	<p>a) They are magnets.</p> <p>b) No, as rings made out of magnetic materials can also attract other magnets. To prove that R is a magnet, it has to be able to repel either P or Q.</p>

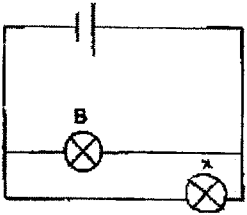
Q35)	<p>a) Set ups B and C.</p> <p>b) D. The set-up has the highest temperature of water and the most exposed surface area.</p> <p>c) Black balls reduce the exposed surface area of water hence the rate of evaporation decreases.</p> <p>d) Trees reduce the surface temperature of water hence rate of evaporation decreases.</p>						
Q36)	<p>a)</p>  <p>b)i)When the switch was closed, there was a closed circuit the iron rod would be magnetised and attract the iron rod.</p> <p>When the iron rod touches the iron bar, the circuit became open and the iron rod demagnetised and the iron bar will drop to the contacts and close the circuit again.</p> <p>ii)The aluminium bar is ab electrical conductor and it will close the circuit. Aluminium is not a magnetic material and it will not be attracted to the iron rod.</p>						
Q37)	<p>a)</p> <table border="1" data-bbox="496 1541 1110 1711"> <tr> <td>100 cm<sup>3</sup></td> <td></td> </tr> <tr> <td>More than 100 cm<sup>3</sup> but less than 150 cm<sup>3</sup></td> <td>✓</td> </tr> <tr> <td>150 cm<sup>3</sup></td> <td>✓</td> </tr> </table> <p>There will be tiny gaps in the dry sand, allowing the water to flow in and occupy the space previously occupied by air.</p> <p>Hence, the total volume will be more than 100cm<sup>3</sup> but less than 150 cm<sup>3</sup></p>	100 cm <sup>3</sup>		More than 100 cm <sup>3</sup> but less than 150 cm <sup>3</sup>	✓	150 cm <sup>3</sup>	✓
100 cm <sup>3</sup>							
More than 100 cm <sup>3</sup> but less than 150 cm <sup>3</sup>	✓						
150 cm <sup>3</sup>	✓						

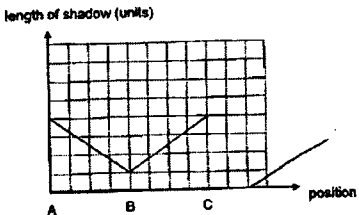
	<p>b) <math>400\text{cm}^3</math> as air has no definite shape and can be compressed. Hence, the volume of air will be able to remain the same.</p>
Q38)	<p>a) Light travels in a straight line and gets blocked by the opaque figure of the boy, forming a shadow.</p> <p>b)</p>  <p>b) As the boy moved further away from the light source, he blocked more light.</p>
Q39)	<p>a) Flexibility.</p> <p>b) X is bent less. It is less flexible and food is less likely to topple.</p> <p>c) You can put as many weights on the materials until it breaks. The material that can hold the most weights without breaking is the strongest.</p>
Q40)	<p>a) When the water is hot, liquid P will heat and expand quickly due to the thin glass bulb allowing it to measure the temperature of the hot water.</p> <p>b) The time taken will be longer as liquid P will take a longer time to gain heat and expand since there is a thicker glass bulb. Hence, it will take longer to get a temperature reading.</p> <p>c) Liquid Y, it had biggest increase in volume the temperature will have the easiest and most accurate reading.</p>