



RED SWASTIKA SCHOOL

RED SWASTIKA SCHOOL

2009 PRELIMINARY EXAMINATION

MATHEMATICS PAPER 1

Name : _____ ()

Class : Primary 6 / _____

Date : 25 August 2009

BOOKLET A

15 Questions

20 Marks

Duration of Paper 1 (Booklets A & B) : 50 minutes

Note:

1. Do not open this Booklet until you are told to do so.
2. Questions 1 - 15 are to be done on the OAS provided.
3. Read carefully the instructions given at the beginning of each part of the Booklet.
4. Do not waste time. If a question is difficult for you, go on to the next one.
5. Check your answers thoroughly and make sure you attempt every question.
6. You are not allowed to use a calculator.

Questions 1 to 10 carry 1 mark each. Questions 11 to 15 carry 2 marks each.
For each question, four options are given. One of them is the correct answer.
Make your choice (1, 2, 3 or 4). Shade the correct oval (1, 2, 3 or 4) on the
Optical Answer Sheet. (20 marks)

- 1 Round off 874 561 to the nearest thousand.

~~(1)~~ 870 000
~~(2)~~ 874 000
~~(3)~~ 875 000
 (4) 880 000

- 2 Evaluate $63 + 20 \times (56 \div 7) - 4$.

~~(1)~~ 143
~~(2)~~ 219
~~(3)~~ 332
 (4) 660

- 3 $5 + \frac{3}{5} + \square = 10.51$

The missing number in the box is _____.

~~(1)~~ 2.51
~~(2)~~ 4.91
~~(3)~~ 5.45
 (4) 5.60

- 4 If a photocopying machine prints 60 copies of a document in a minute, how long will it take to print 4 500 copies?

~~(1)~~ $1\frac{1}{5}$ h
~~(2)~~ $1\frac{1}{4}$ h
~~(3)~~ $1\frac{2}{5}$ h
 (4) $1\frac{3}{20}$ h

5 Osman had \$30. If he spent \$18, what percentage of his money had he left?

- ~~(1)~~ 3.6%
- ~~(2)~~ 5.4%
- ~~(3)~~ 40%
- ~~(4)~~ 60%

6 A rectangular tank when full contains 840 ml of water. The base measures 12 cm by 10 cm. Find the height of the tank.

- ~~(1)~~ 7 cm
- ~~(2)~~ 70 cm
- ~~(3)~~ 84 cm
- ~~(4)~~ 720 cm

7 The figure below shows a quadrant. Find its perimeter in terms of π .

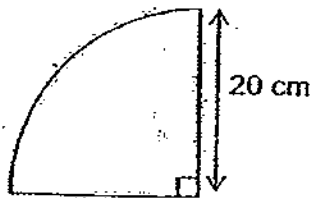

- ~~(1)~~ (10π) cm
- ~~(2)~~ (40π) cm
- ~~(3)~~ $(10\pi + 40)$ cm
- ~~(4)~~ $(40\pi + 40)$ cm

8 What is the reading at Point X?

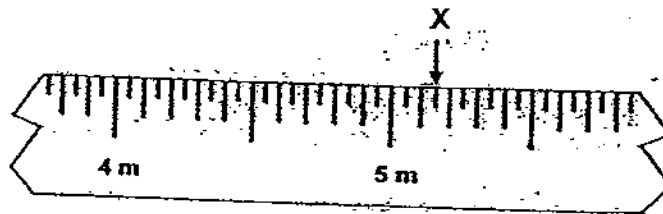

- ~~(1)~~ 5.15 m
- ~~(2)~~ 5.20 m
- ~~(3)~~ 5.25 m
- ~~(4)~~ 5.30 m

9 Which one of the following is a net of Figure A?

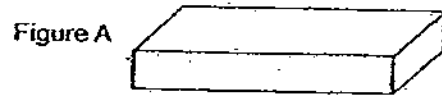

10 The figure below is not drawn to scale. ABCD is a rhombus. Find $\angle x$.

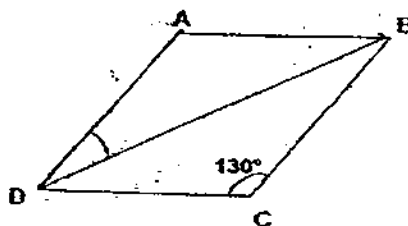

- ~~A~~ 25°
- ~~B~~ 50°
- ~~C~~ 65°
- ~~D~~ 130°

- 11 Some children were seated around a round table. A plate with 53 mini donuts on it was passed around the table. Each child took the same number of mini donuts except for Syed. He happened to take the first and the last mini donut. If he had taken a total of 5 mini donuts, how many children were there at the table?

- ~~A~~ 12
~~B~~ 13
~~C~~ 16
~~D~~ 17

- 12 A basket can hold either 12 guavas or 15 apples. If there are only 8 guavas in the basket, how many apples can be put in the same basket?

- ~~A~~ 5
~~B~~ 7
~~C~~ 10
~~D~~ 15

- 13 The figure below, not drawn to scale, shows 2 identical overlapping rectangles, forming a square at the corner. Find the total area of the unshaded parts.

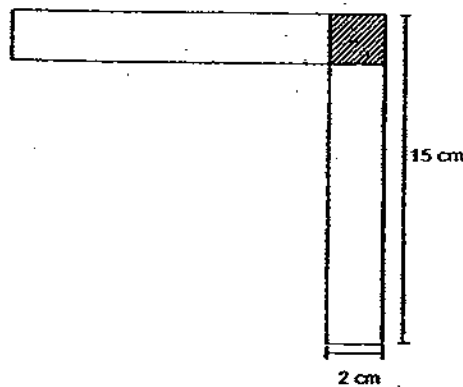

- ~~A~~ 26 cm²
~~B~~ 30 cm²
~~C~~ 52 cm²
~~D~~ 56 cm²

- 14 In the diagram below, not drawn to scale, PQ is parallel to RS. PS and RQ are straight lines. Find $\angle a$.

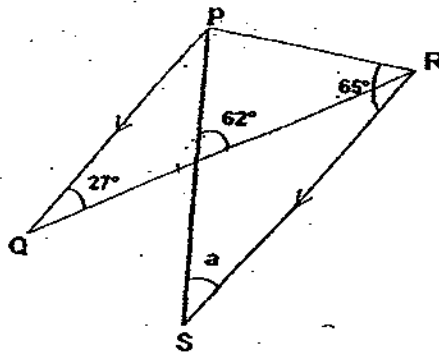

- (1) 26°
- (2) 35°
- (3) 53°
- (4) 80°

- 15 Mr Wong has many shirts of different colours in his wardrobe and they are represented by the pie chart below. EF and GH are the diameters of the circle. If he has 12 grey shirts, how many white shirts does he have?

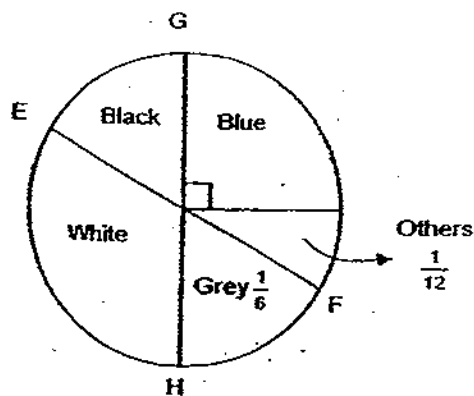

- (1) 12
- (2) 24
- (3) 48
- (4) 60



RED SWASTIKA SCHOOL

RED SWASTIKA SCHOOL

2009 PRELIMINARY EXAMINATION

MATHEMATICS PAPER 1

Name : _____ ()

Class : Primary 6 / _____

Date : 25 August 2009

BOOKLET B

15 Questions
20 Marks

MARKS

	OBTAINED	POSSIBLE
BOOKLET A		20
BOOKLET B		20
TOTAL		40

Parent's Signature : _____

Questions 16 to 25 carry 1 mark each. Write your answers in the spaces provided. For questions which require units, give your answers in the units stated. (10 marks)

A survey was conducted to find out the number of pupils who had digital watches and the number of digital watches they had. The pie chart shows the percentage of pupils in each group. Study the table and the pie chart below carefully and answer questions 16 to 18.

Group	No. of Digital Watches
A	0
B	1
C	2
D	More than 2

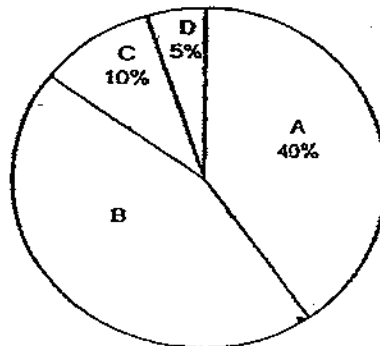

- 16 According to the survey, 80 pupils did not have a digital watch. How many pupils took part in the survey?

Ans: _____

- 17 What fraction of the total number of pupils had only 1 digital watch? Express your answer in its simplest form.

Ans: _____

- 18 How many pupils had more than 1 digital watch?

Ans: _____

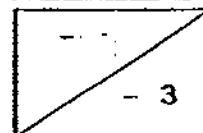

- 19 Zhiwei travelled at an average speed of 100 km/h from Town Kurau to Town Limau. The distance between the two towns was 250 km. If he reached Town Limau at 1.50 p.m., what time did he leave Town Kurau?

Ans: _____ a.m.

- 20 Four children teamed up to take part in the Singapore History Challenge. At the end of the Challenge, they found out that part of their score sheet was torn. How many marks did Arasu and Celia score respectively?

	Rodney	Arasu	Celia	Zaini	Average
Marks	89	6	7	71	73

Ans: Arasu = _____

Celia = _____

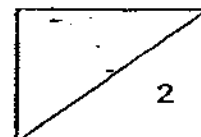

- 21 Find the perimeter of the figure below.

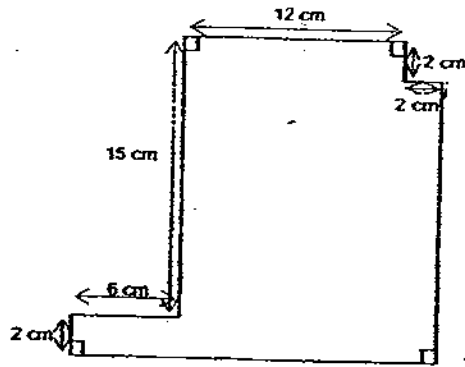

Ans: _____ cm

- 22 Evaluate $\frac{3}{10} \div 12$ and express your answer in its simplest form.

Ans: _____

- 23 Yong Liang mixed a cocktail drink for a Christmas party by mixing wine with grape juice in the proportion of 3 : 15 respectively. How much wine must he mix with 300 ml of grape juice?

Ans: _____ ml

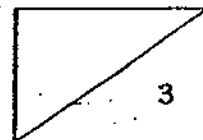

- 24 The figure below is made up of squares. Shade two squares so that the dotted line is a line of symmetry of the figure.

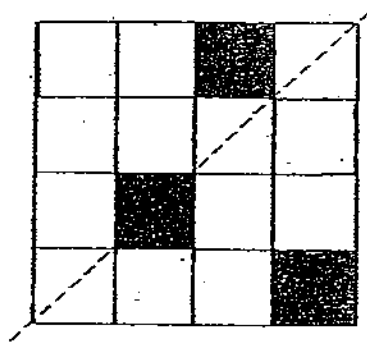

- 25 Triangle STU is not drawn to scale. Find $\angle e + \angle f + \angle g + \angle h$.

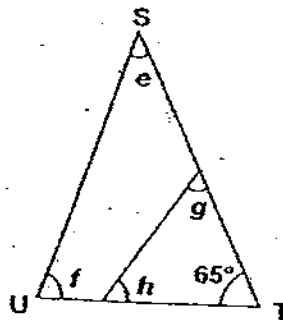

Ans: _____°

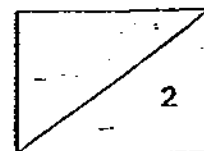

Questions 26 to 30 carry 2 marks each. Show your working clearly in the space provided for each question and write your answers in the spaces provided. For questions which require units, give your answers in the units stated.
(10 marks)

- 26 In the diagram below, not drawn to scale, PQRS is a parallelogram. Find $\angle QSR$.

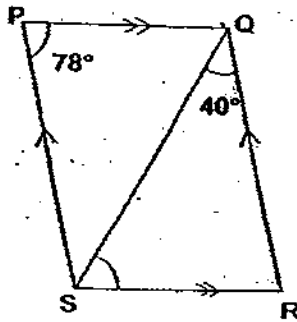

Ans: _____°

- 27 The total cost of Bag Y and Bag Z is \$ p . Bag Y costs \$7 more than Bag Z. Find the cost of Bag Z in terms of p .

Ans: \$ _____

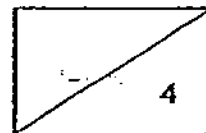

28 $8.19 \times 1\,000 = \boxed{} \div 10$

What is the missing number in the box?

Ans: _____

- 29 Place the numbers 2, 3, 4 and 5 in the boxes below.
Each number can only be used once. The sum of all the numbers must be equal when added vertically and horizontally.

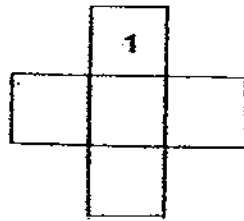

- 30 Rahmat is 1.7 m tall and he casts a shadow that is 85 cm long.
A tree next to him casts a shadow of 1.5 m long. How tall is the tree?

Ans: _____ m

END OF PAPER 1

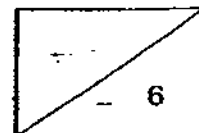



RED SWASTIKA SCHOOL

RED SWASTIKA SCHOOL

2009 PRELIMINARY EXAMINATION

MATHEMATICS PAPER 2

Name : _____ ()

Class : Primary 6 / _____

Date : 25 August 2009

18 Questions

60 Marks

Duration of Paper 2 : 1 hour 40 minutes

Note:

1. Do not open this Booklet until you are told to do so.
2. Read carefully the instructions given at the beginning of each part of the Booklet.
3. Do not waste time. If a question is difficult for you, go on to the next one.
4. Check your answers thoroughly and make sure you attempt every question.
5. You are allowed to use a calculator.

MARKS

	OBTAINED	POSSIBLE
PAPER 1		40
PAPER 2		60
TOTAL		100

Parent's Signature : _____

Questions 1 to 5 carry 2 marks each. Show your working clearly in the space below each question and write your answers in the spaces provided. For questions which require units, give your answers in the units stated.

(10 marks)

-
- 1 Chee Kiong was given \$55 on his birthday. This was 8% of his original savings. What was his original savings?

Ans: \$ _____

-
- 2 Louisa is k years old this year. Her brother is 3 years younger than she. What would their total age be in 5 years' time?
Give your answer in terms of k .

Ans: _____ years old

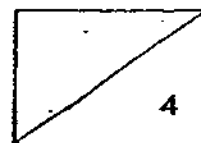

- 3 A 3-room flat has a rectangular living room with an area of 30.15 m^2 and a width of 4 m. Find the length of the living room, correct to 2 decimal places.

Ans: _____ m

- 4 Study the patterns in the table below carefully.

Pattern 1	2 grey squares + 1 white square
Pattern 2	4 grey squares + 3 white squares
Pattern 3	6 grey squares + 5 white squares
Pattern 4	8 grey squares + 7 white squares
Pattern 5	10 grey squares + 9 white squares
Pattern 6	12 grey squares + 11 white squares
⋮	⋮
⋮	⋮
⋮	⋮
Pattern 50	?

How many grey squares and white squares are there in Pattern 50?

Ans: _____ grey and _____ white

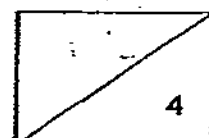

- 5 The pattern in the box shows part of a tessellation.
Extend the tessellation by drawing two more unit shapes in the space provided within the box.

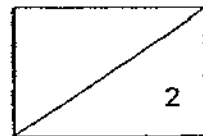
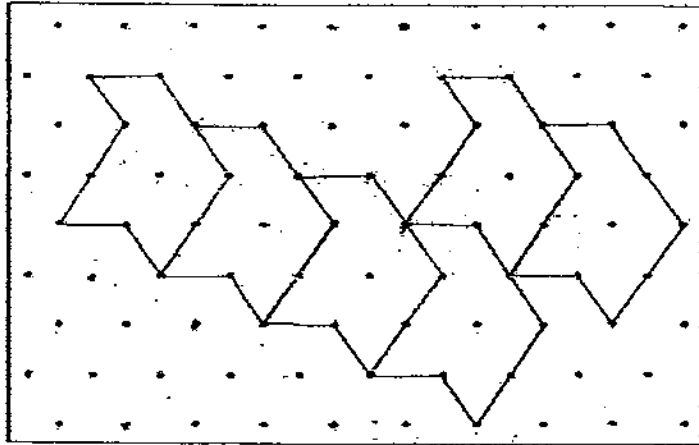

For Questions 6 to 18, show your working clearly in the space below each question and write your answers in the spaces provided.
The number of marks available is shown in brackets [] at the end of each question or part-question. (50 marks)

- 6 At a party, a box of candies was divided equally among 114 children. 38 of these children gave up their candies. As a result, there were 228 more candies shared among the remaining children. How many candies were there in the box at first?

Ans: _____ [3]

- 7 A tank was $\frac{1}{4}$ full of water. Hazlin poured 3.8 l of water into the tank and the tank became $\frac{7}{9}$ full. How much water was in the tank at first?

Ans: _____ [3]

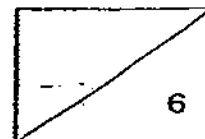

- 8 Michael spends 25% of his monthly allowance on transport. He spends 60% of the remainder on food and saves the rest. What percentage of his monthly allowance does he save?

Ans: _____ [3]

- 9 The ratio of the number of toy cars Jackson has to the number of toy cars Kris has is 3 : 5. The ratio of the number of toy cars Kris has to the number of toy cars Adam has is 3 : 4. If Jackson has 22 toy cars less than Adam, how many toy cars does Kris have?

Ans: _____ [3]

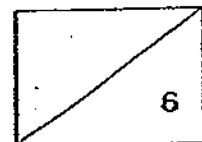

- 10 The figure below is not drawn to scale. MN is parallel to OK. O is the centre of the circle. Find $\angle NKL$.

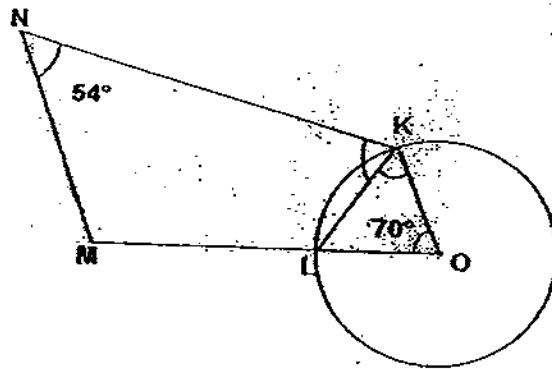

Ans: _____ [3]

- 11 HIJK is a rectangle. Find the length of HK.

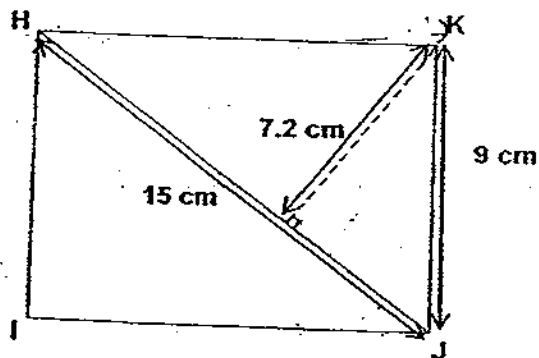

Ans: _____ [3]

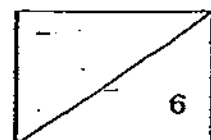

- 12 The figure shows 2 semi-circles overlapping a bigger semi-circle. The diameters of the 3 semi-circles form the sides of a right-angled triangle ABC on the biggest semi-circle where $AB = 16$ cm, $BC = 12$ cm and $AC = 20$ cm. Find the area of the shaded region. (Take $\pi = 3.14$)

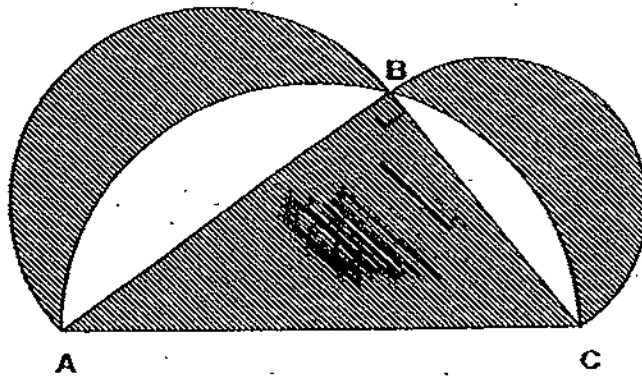

Ans: _____ [4]

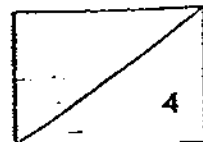

- 13 A rectangular empty tank was fitted with 3 taps. Water flowed from Tap A at a rate of 3ℓ per minute. 4 minutes later, Tap B was turned on and water flowed at a rate of 5ℓ per minute from it. 7 minutes after Tap B was turned on, Tap C was turned on and water was drained out at a rate of 9ℓ per minute. Another 8 minutes later, all the 3 taps were turned off. What was the height of the water level in the tank in the end?

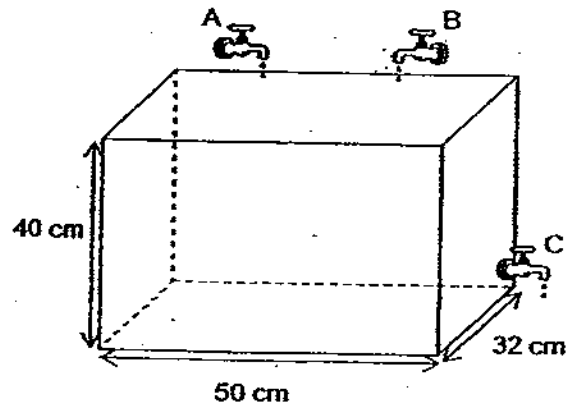

Ans: _____ [4]

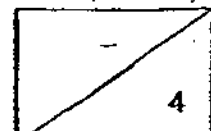

- 14 The table below shows Mdm Yong's utilities usage for the month of September.

Utilities	No. of units used	Cost per unit
Electricity	552	\$0.18
Water	11	\$1.17

- (a) How much did Mdm Yong pay for her electricity usage?
- (b) If Mdm Yong had to pay a water conservation tax of 30%, how much would her **total** utilities bill be? Correct your answer to 2 decimal places.

Ans: (a) _____ [1]

(b) _____ [3]

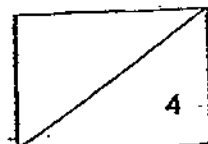

- 15 Amelia has a stamp collection. 60% of them are Japanese stamps and the rest are Korean stamps. She gave away 63 Korean stamps and 25% of the Japanese stamps. She then had $\frac{5}{8}$ of her stamp collection left. How many stamps did Amelia give away?

Ans: _____ [5]

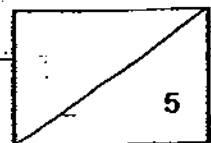

- 16 Uncle Sunny had only 2 types of plants, orchids and roses, in his nursery. There were 520 pots of orchids more than roses in the nursery in the month of June. In July, Uncle Sunny grew more orchids and the number of pots of orchids increased by 20%. In the same month, he sold some roses and the number of pots of roses decreased by 10%. If there were a total of 2 052 pots of plants in the nursery in July, how many pots of orchids were there in June?

Ans: _____ [5]

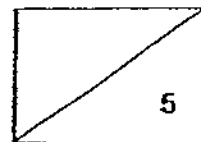

- 17 To keep herself fit, Wiyathi climbs up a flight of 30 steps every day. If she runs up 5 steps and walks up 25 steps, she will take 99 seconds. If she runs up 15 steps and walks up 15 steps, she will take 18 seconds less. How long will she take to run up all the 30 steps if she maintains the same speed?

Ans: _____ [5]

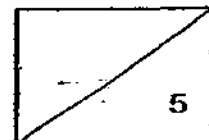

- 18 The table below shows the scoring system at a basketball tournament. A team is awarded 5 points for a win, 2 points for a draw and no point for a loss.

Win	Draw	Loss
5 points	2 points	0 point

At the end of the tournament, Team Alpha played a total of 36 matches (won, drew or lost) and accumulated 120 points. How many matches did Team Alpha win if they had lost 9 matches?

Ans: _____ [5]

END OF PAPER 2

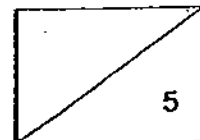



ANSWER SHEET

EXAM PAPER 2009

SCHOOL : RED SWASTIKA PRIMARY
SUBJECT : PRIMARY 6 MATHEMATICS

TERM : PRELIM

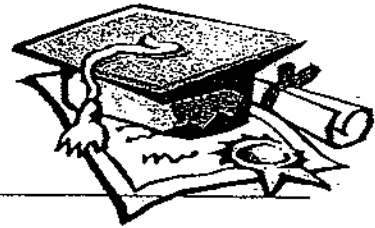

Q1	Q2	Q3	Q4	Q5	Q6	Q7	Q8	Q9	Q10	Q11	Q12	Q13	Q14	Q15
3	2	2	2	3	1	3	1	4	1	2	1	3	2	2

16)200 17)9/20 18)30 19)11.20a.m. 20)A:65 C:67

21)74cm 22)1/40 23)60ml 24)  25)230°

26)62° 27)\$(p-7/2) 28)81900 29)
$$\begin{matrix} 1 \\ 2 & 3 & 4 \\ 5 \end{matrix}$$

30)3m

Paper 2

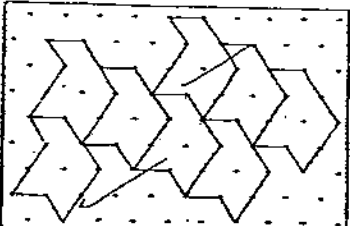
<p>1)8%-->\$55 Chee Kiong's original savings $= (\\$55 \div 8) \times 100 = \\687.50</p>	<p>2)Louisa→K years old brother→K-3years old Total age=K+5+K-3+5=2K+7</p>
<p>3)Length of the living room $= 30.15m^2 \div 4m \approx 7.54m$</p>	<p>4)Grey→$50 \times 2 - 100$ White→$(44 \times 2) + 11 = 99$</p>
<p>5) </p>	<p>6)38children→228 candies 1 child→6 candies No.of candies in the box at first $= 114 \times 6 = 684$</p>

<p>7) $28-9=19$ $19u \rightarrow 3.8L$ $1u \rightarrow 0.2L$ Amount of water = $0.2L \times 9$ = $1.8L$</p>	<p>8) 60% of 75% \rightarrow 45% percentage save = $100\% - 25\%$ - $45\% = 30\%$</p>
<p>9) $20-9=11$ $11u \rightarrow 22$ $1u \rightarrow 2$ No. of toy cars Kris have = $2 \times 15 = 30$</p>	<p>10) $(180^\circ - 70^\circ) \div 2 = 55^\circ$ $\angle NKL = 180^\circ - 54^\circ - 55^\circ = 71^\circ$</p>
<p>11) $\frac{1}{2} \times 7.2cm \times 15cm = 54cm^2$ Length of HK = $54cm^2 \div 9 \div \frac{1}{2}$ = $12cm$</p>	<p>12) $\frac{1}{2} \times 12cm \times 16cm = 96cm^2$ Unshaded area $(\frac{1}{2} \times 3.14 \times 10 \times 10cm) - 96cm^2 = 61cm^2$ $\frac{1}{2} \times 3.14 \times 8cm \times 8cm = 100.48cm^2$ $\frac{1}{2} \times 3.14 \times 6cm \times 6cm = 56.52cm^2$ $100.48cm^2 + 56.52cm^2 = 157cm^2$ $157cm^2 - 61cm^2 = 96cm^2$ Shaded region = $96cm^2 \times 2$ = $192cm^2$</p>
<p>13) $3L/min \times 4min = 12L$ $5L/min + 3L/min = 8L/min$ $8L/min \times 7 = 56L$ $56L + 12L = 68L$ $9L/min - 8L/min = 1L/min$ $1L/min \times 8 = 8L$ $68L - 8L = 60L$ $60L \rightarrow 60000cm^3$ Height of the water Level in the end = $60000cm^3 \div 50cm \div 32cm$ = $37.5cm$</p>	<p>14) a) Amount Mdm Yong paid = $552 \times \\$0.18 = \\99.36 $11 \times \\$1.17 = \\12.87 b) Total utilities bill = $\\$99.36 +$ $(\\$12.87 \div 100 \times 130)$ $\approx \\$116.09$</p>

15)105 stamps	16)2052-624=1428 2.1u→1428 1u→680 No. of orchids in June =680+520=1200
17)54 seconds	18)22 matches