

PRELIM

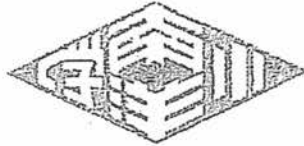

NANYANG PRIMARY SCHOOL
PRELIMINARY EXAMINATION
2017

PRIMARY 6
MATHEMATICS
PAPER 1

DURATION: 50 MINUTES

Booklet A	/ 20
Booklet B	/ 20

Paper 1 Total: / 40

Name: _____ ()

Class: Primary 6 ()

Date: 23 August 2017

Any query on marks awarded should be raised by 14 September 2017.
We seek your understanding in this matter as any delay in the
confirmation of marks will lead to delays in the generation of results.

Parent's Signature: _____

DO NOT OPEN THIS BOOKLET UNTIL YOU ARE TOLD TO DO SO.
FOLLOW ALL INSTRUCTIONS CAREFULLY.
ANSWER ALL QUESTIONS.

YOU ARE NOT ALLOWED TO USE A CALCULATOR.

PAPER 1 (BOOKLET A)

Questions 1 to 10 carry 1 mark each. Questions 11 to 15 carry 2 marks each. For each question, four options are given. One of them is the correct answer. Make your choice (1, 2, 3 or 4). Shade the oval (1, 2, 3 or 4) on the Optical Answer Sheet.

(20 marks)

1 Find the value of $873 - 418 + 229$.

- (1) 226
- (2) 684
- (3) 1062
- (4) 1520

2 Which one of the following is not a common factor of 16 and 72?

- (1) 8
- (2) 2
- (3) 3
- (4) 4

3 What does the digit 8 in 10.801 stand for?

- (1) 8 ones
- (2) 8 tenths
- (3) 8 hundredths
- (4) 8 thousandths

4 Find the value of $0.45 \div 9$.

- (1) 0.05
- (2) 0.09
- (3) 0.5
- (4) 0.9

- 5 The rectangular block of wood shown below was cut into four equal pieces. What was the volume of each piece of the wood?

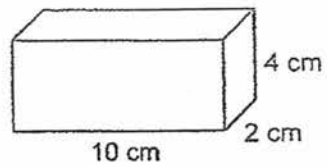

- (1) 80 cm^3
- (2) 20 cm^3
- (3) 16 cm^3
- (4) 4 cm^3

- 6 In the figure, KL is a straight line. Find the sum of $\angle a$ and $\angle b$.

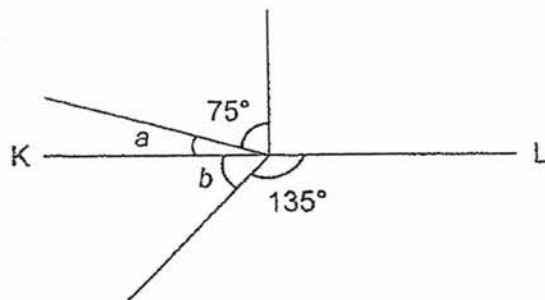

- (1) 15°
- (2) 45°
- (3) 60°
- (4) 90°

7 Which one of the following figure is **not** a net of a cube?

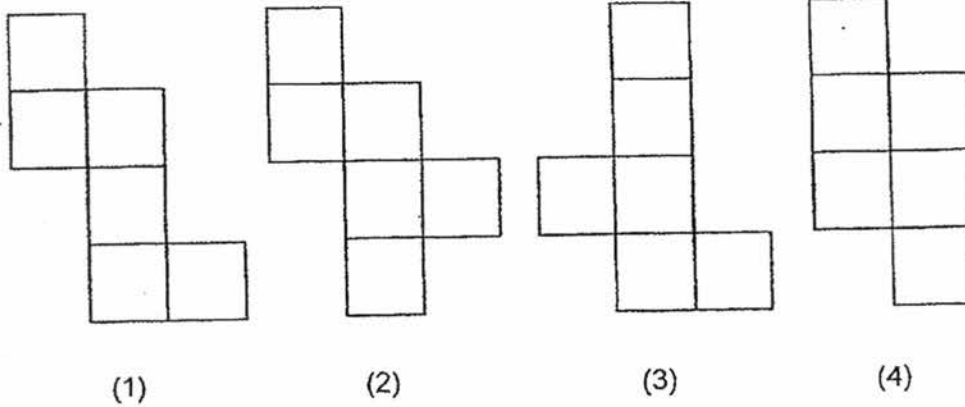

8 There are 16 students in Group A. Group A has 12 fewer students than Group B. Find the ratio of the number of students in Group A to that in Group B.

- (1) 1 : 4
- (2) 4 : 1
- (3) 4 : 7
- (4) 7 : 4

- 9 Hamzah was given a 20% discount for a pair of sneakers. How much was the discount?



- (1) \$20.30
(2) \$23.00
(3) \$81.20
(4) \$121.80
- 10 Vijay studied the population of three countries, P, Q and R. He found out that:
- Country P's population was half that of Country Q.
 - Country R's population was 15 000 less than that of Country P.

Arrange the countries from the one with the largest population to the one with the smallest population.

- (1) Country Q, Country R, Country P
(2) Country P, Country R, Country Q
(3) Country Q, Country P, Country R
(4) Country R, Country P, Country Q

11 The perimeter of a rectangle is 40 cm. The length of the rectangle is 4 cm more than its breadth. Find the length of the rectangle.

- (1) 8 cm
- (2) 12 cm
- (3) 18 cm
- (4) 22 cm

12 The solid below is made up of 1-cm cubes. How many more 1-cm cubes are needed to build a cube of edge 4 cm?

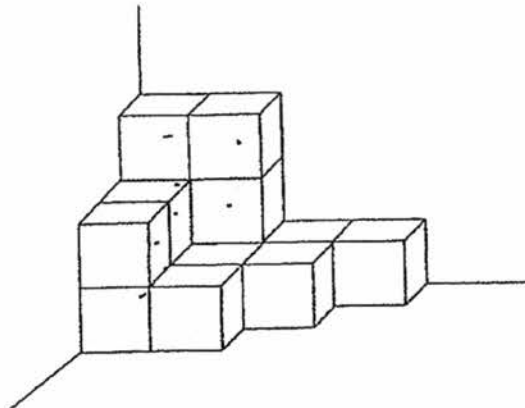

- (1) 15
- (2) 49
- (3) 53
- (4) 64

13 Refer to the square grid below.

Mr Happy is resting at point X. In which direction is the house (🏠) from point X (🌳)?

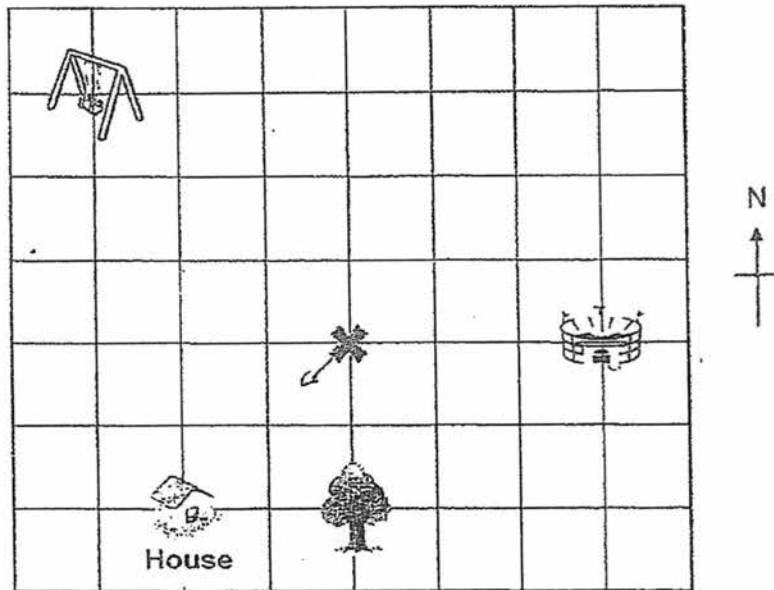

- (1) North-east
- (2) North-west
- (3) South-east
- (4) South-west

- 14 There were some blue, red, green and yellow highlighters in a shop. The pie chart below shows the number of highlighters of each colour. 60% of them were green and yellow. How many blue highlighters were there?

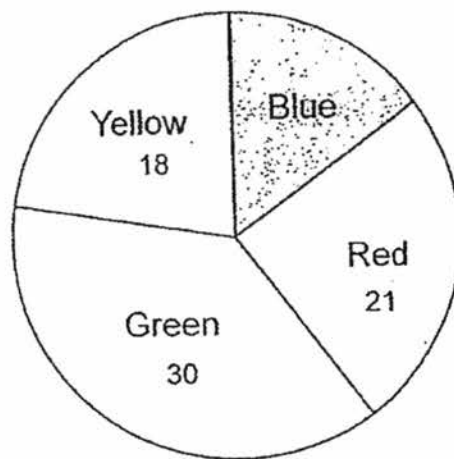

- (1) 11
- (2) 19
- (3) 31
- (4) 32

- 15 Geena had $8y$ paper clips. She used 4 paper clips and gave the rest to her friends, Megan and Bryan. Megan received twice as many paper clips as Bryan. Find the number of paper clips Bryan received in terms of y .

(1) $\frac{8y-4}{2}$

(2) $\frac{8y-4}{3}$

(3) $\frac{16y-8}{2}$

(4) $\frac{16y-8}{3}$

Name: _____ () Class: Pr 6 ()

PAPER 1 (BOOKLET B)

Questions 16 to 25 carry 1 mark each. Write your answers in the spaces provided. For questions which require units, give your answers in the units stated.

(10 marks)

- 16 Given that $12 \times 44 = 528$, what is the missing number in the box below?

$$120 \times 44 = \boxed{?} \times 528$$

Ans: _____

- 17 Find the difference between $\frac{3}{4}$ and $\frac{1}{3}$.

Ans: _____

- 18 Mingwei poured 3 litres of orange juice equally into 4 bottles. What was the total volume of orange juice in 3 such bottles? Give your answer as a mixed number in the simplest form.

Ans: _____ litres

19 Round off 29.098 to the nearest whole number.

Ans: _____

20 At 11 50, Ali left his house for the library. It took him half an hour to reach the library. What time did Ali reach the library?

Ans: _____

21 Express 30 g in kg.

Ans: _____ kg

22 In the figure, ABCD and EFGH are identical parallelograms. BC is parallel to FG, $\angle BCD = 65^\circ$ and $\angle DHE = 45^\circ$. Find $\angle CDH$.

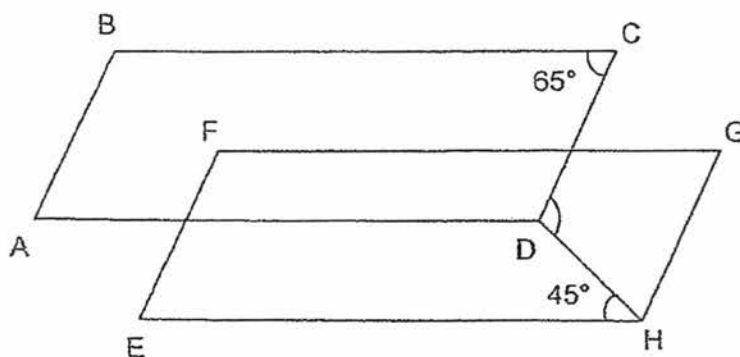

Ans: _____°

- 23 The figure is made up of identical squares and identical triangles. Shade 4 more squares to form a symmetric figure with AB as the line of symmetry.

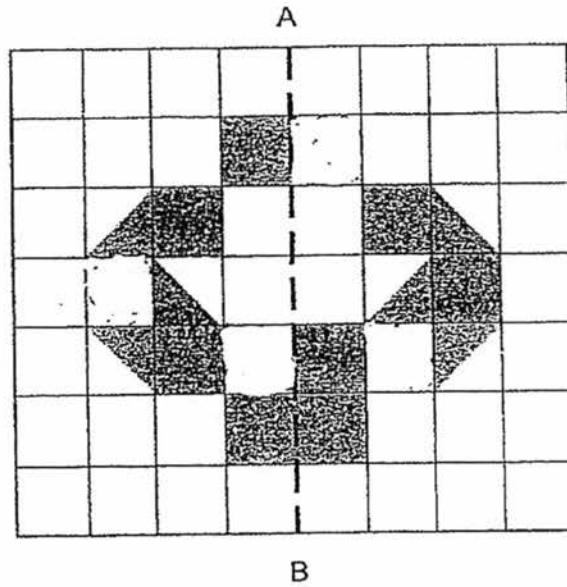

- 24 Matthew's height is 120 cm. The ratio of Matthew's height to Kelly's height is 4 : 5. Find Kelly's height.

Ans: _____ cm

- 25 Messi took 20 minutes to travel 2 km. Find Messi's average speed in m/min.

Ans: _____ m/min

Questions 26 to 30 carry 2 marks each. Show your working clearly in the space provided for each question and write your answers in the spaces provided. For questions which require units, give your answers in the units stated.

(10 marks)

- 26 Part of a tessellation is shown below. Extend the tessellation by drawing 2 more unit shapes within the grid.

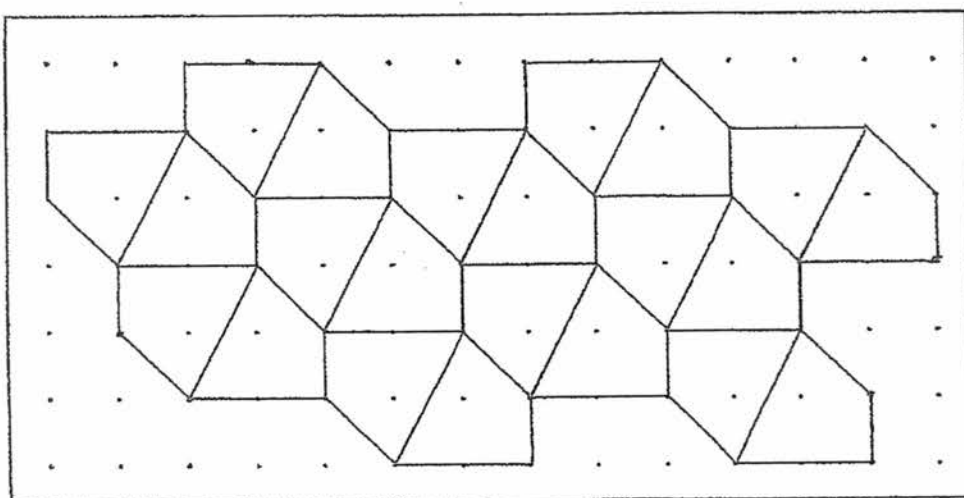

- 27 Khalid wants to cut squares of side $\frac{1}{3}$ m from a rectangular piece of paper measuring 4 m by 2 m. At most, how many of such squares can he cut?

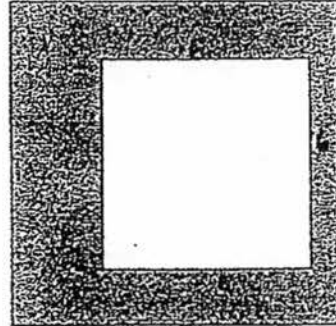

Ans: _____

- 28 The figure below is made up of two squares. The perimeter of the smaller square is 24 cm and the area of the shaded part is 45 cm². Find the length of one side of the bigger square.



Ans: _____ cm

- 29 Yesung and Minho bought some pens and some pencils from a shop at the prices shown below.

Pens	Pencils
<p data-bbox="416 517 643 551">\$4 for a pack of 3</p> 	<p data-bbox="871 517 1098 551">\$3 for a pack of 3</p> 

Yesung bought 6 more pens than Minho. Minho bought 3 more pencils than Yesung. What was the difference in the amount of money Yesung and Minho spent at the shop?

Ans: \$ _____

30 . A rectangle Y is drawn by joining dots on the square grid below with four straight lines. Lines must meet at the dots in the given grid. In the same way,

(a) draw a rectangle, with the same area as Y, that gives the largest possible perimeter. Label the rectangle R.

(b) draw an isosceles triangle with half the area as Y. Label the triangle T.

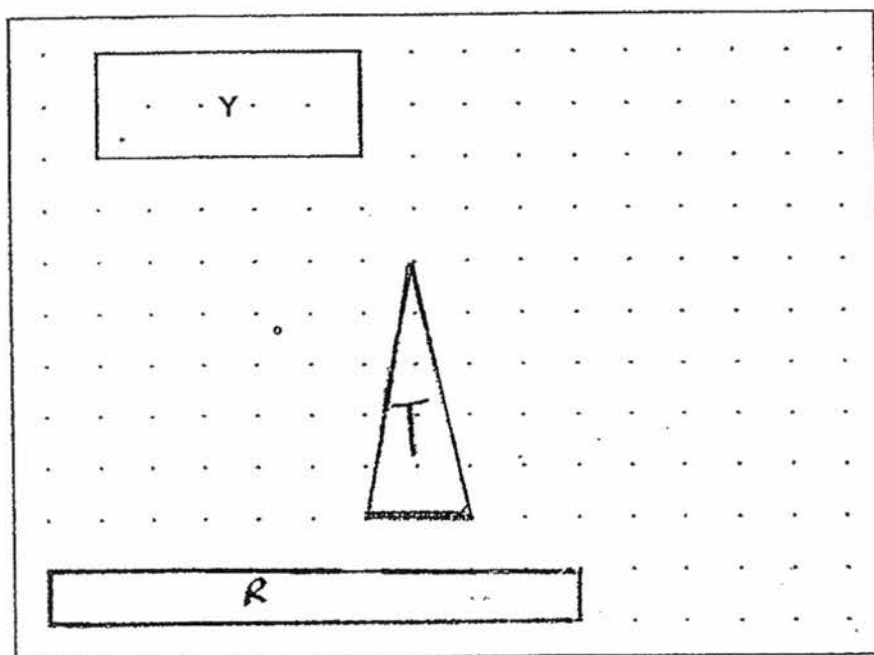

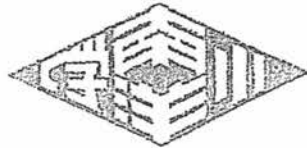

NANYANG PRIMARY SCHOOL
PRELIMINARY EXAMINATION
2017

PRIMARY 6
MATHEMATICS
PAPER 2

DURATION: 1 HOUR 40 MINUTES

Paper 2 Total	/ 60
GRAND TOTAL	/ 100

Name: _____ ()

Class: Primary 6 ()

Date: 23 August 2017

Any query on marks awarded should be raised by 14 September 2017.
We seek your understanding in this matter as any delay in the
confirmation of marks will lead to delays in the generation of results.

Parent's Signature: _____

DO NOT OPEN THIS BOOKLET UNTIL YOU ARE TOLD TO DO SO.
FOLLOW ALL INSTRUCTIONS CAREFULLY.
ANSWER ALL QUESTIONS.

YOU ARE ALLOWED TO USE A CALCULATOR.

PAPER 2

Questions 1 to 5 carry 2 marks each. Show your working clearly in the space provided for each question and write your answers in the spaces provided. For questions which require units, give your answers in the units stated.

(10 marks)

-
- 1 Reika's mass was 48 kg last year. She lost 6 kg this year. What was the percentage decrease in her mass?

Ans: _____ %

- 2 A 5-cm cube was removed from each corner of a cuboid measuring 40 cm by 30 cm by 20 cm. What was the volume of the remaining solid?

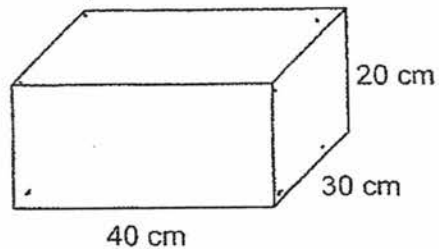

Ans: _____ cm³

- 3 Roy is 6 years older than Sue while Tom is 9 years older than Sue. The sum of their ages is 81.

The bar model below illustrates the age of the three children.

- (a) Insert a pair of brackets, (), in the mathematical expression beside the bar model, so that the mathematical expression represents Roy's age. [1]

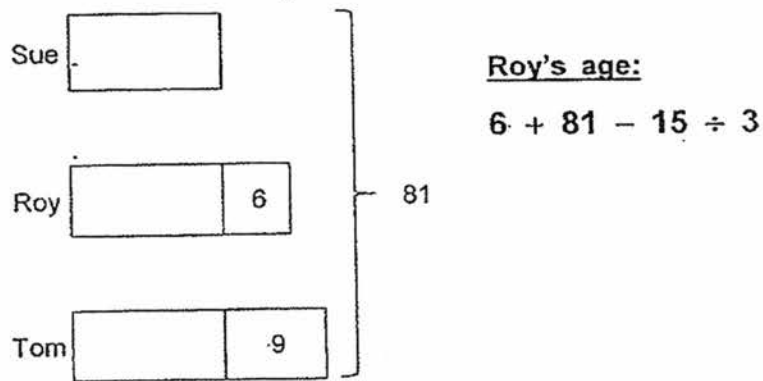

- (b) Find Roy's age.

Ans: (b) _____ [1]

- 4 The length and the breadth of a rectangle were each increased by 11 cm. Find the increase in the perimeter of the rectangle.

Ans: _____ cm

- 5 A, B and C are three 2-digit numbers. Their average is 55. The value of A is twice the value of B. Find the smallest possible value of C.

Ans: _____

For questions 6 to 18, show your working clearly in the space provided for each question and write your answers in the spaces provided.

The number of marks available is shown in brackets [] at the end of each question or part-question.

(50 marks)

- 6 Krishnan and Shobana had the same amount of money. Using all his money, Krishnan could buy 16 apricots or 24 oranges. Shobana bought 10 apricots and 5 oranges. At most, how many oranges could Shobana buy with her remaining money?

Ans: _____ [3]

- 7 Mr Kek spent $\$(4n + 5)$ on a pen and $\$7$ on a book. He divided his remaining money equally among his three children. Each of his children received $\$n$, find the amount of money Mr Kek have at first in terms of n in the simplest form.

Ans: _____ [3]

- 8 Yang bought thrice as many blue marbles as pink marbles. He spent as much money on the blue marbles as he did on the pink marbles. The difference between the cost of each blue marble and that of each pink marble was $\$0.60$. Find the cost of each pink marble.

Ans: _____ [3]

- 9 Mdm Nora paid \$11.70 for two identical sacks of rice using the Saver's Coupon as shown below. How much more would she have to pay for two such sacks of rice if she did not use the coupon?

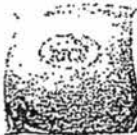
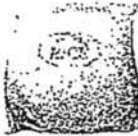
 *SAVE & SHOP SUPERMART* 

SAVER'S COUPON

Buy the 1st sack at 20% discount
and the 2nd sack at 50% discount.

Ans: _____ [3]

- 10 Shi Jin has 4 bottles labelled E, F, G and H respectively. The bar graph below shows the volume of water in each bottle. The bars that show the volume of water in Bottle E and Bottle F have not been drawn.

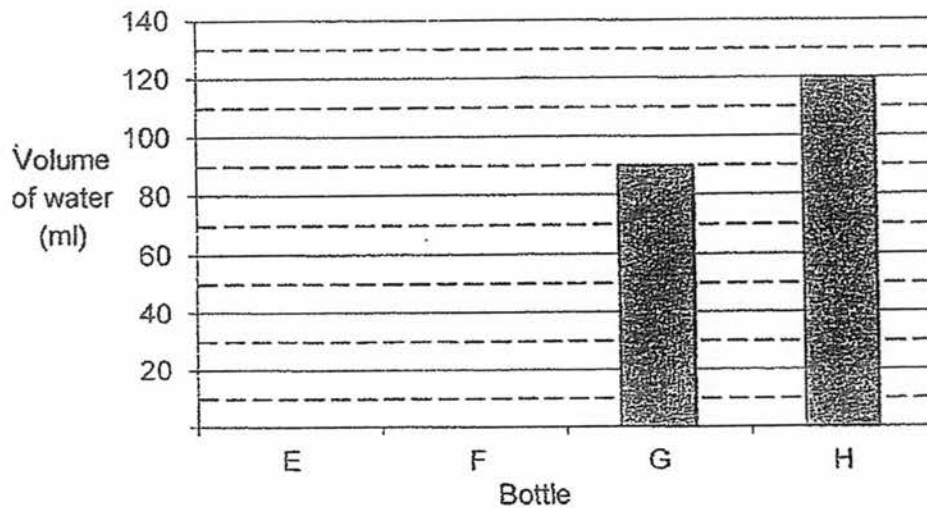

The ratio of the volume of water in Bottle E to the total volume of water in the 4 bottles is 2 : 9. Bottle F contains 40 ml more water than Bottle E. Find the total volume of water in the 4 bottles.

Ans: _____ [4]

- 11 The figure is made up of 3 identical quarter circles and a right-angled isosceles triangle. $\angle ABC = 90^\circ$ and $AB = BC$. The length of AC is 6 cm. Find the area of the figure. Take $\pi = 3.14$.

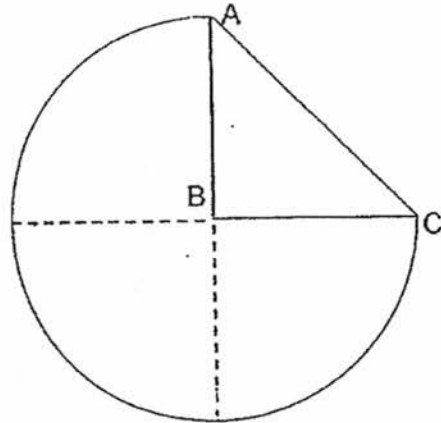

Ans: _____ [4]

- 12 The figure below shows Tap X, Tap Y, Tap Z and an empty rectangular tank measuring 50 cm by 30 cm by 60 cm. Water flows from Tap X at a rate of 2 litres per minute and from Tap Y at 3 litres per minute to fill the tank. Tap Z drains water out of the tank at a rate of 10 litres per minute.

Tap X was turned on at 2 p.m. Tap Y was turned on 5 minutes later. Tap Z was turned on at 2.20 p.m. All three taps were turned off at 2.30 p.m.

- (a) What was the volume of water in the tank at 2.30 p.m.?
(b) What was the height of the water level in the tank at 2.30 p.m.?

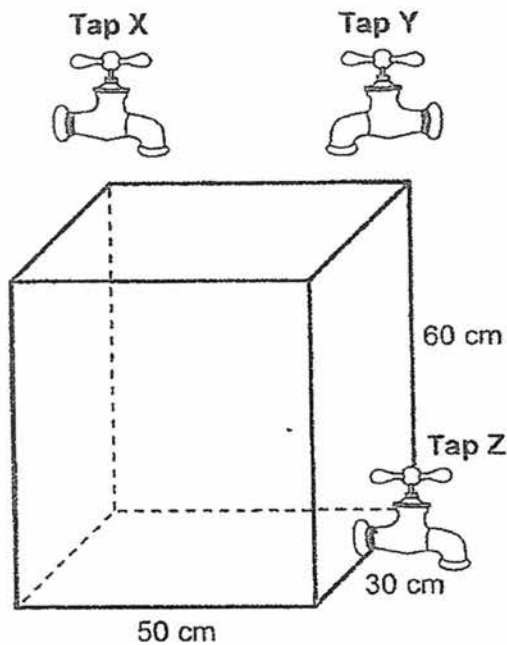

Ans: (a) _____ [2]

(b) _____ [2]

- 13 In the figure, ABCH is a rhombus. ACD, AHF and DEF are straight lines. HE is parallel to GF and HE = HF. $\angle ABC = 110^\circ$ and $\angle HFG = 20^\circ$. Find $\angle CDE$.

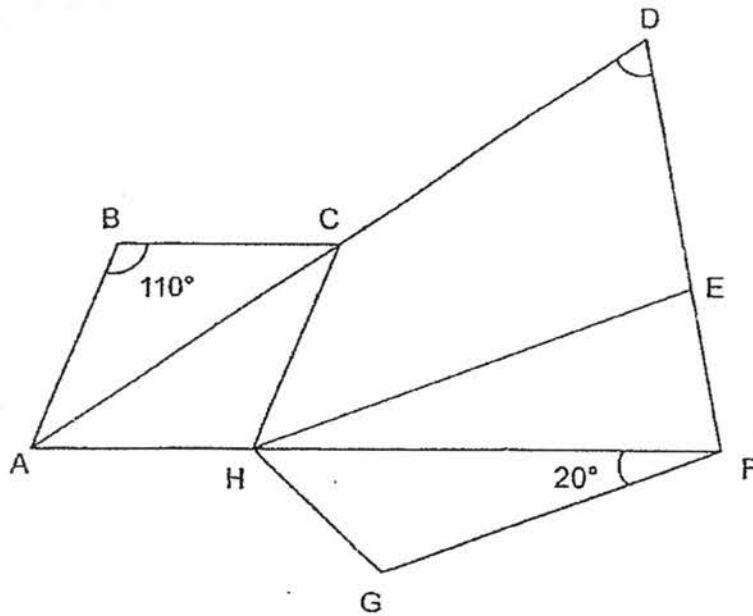

Ans: _____ [4]

14 Study the number pattern below.

12, 15, 18,, 93, 96, 99.

The pattern is made up of all the 2-digit multiples of 3 written in increasing order.

- (a) Find the sum of all the numbers in the pattern.
- (b) How many numbers in the pattern do not contain the digit 3?

Ans: (a) _____ [2]

(b) _____ [2]

15 .A brown bag and a blue bag contained some notes. They each had a mix of \$2 and \$5 notes. The brown bag had 5 more \$2 notes than the blue bag. The blue bag had 2 more \$5 notes than the brown bag. $\frac{3}{4}$ of the number of notes in the blue bag was equal to $\frac{2}{3}$ of the number of notes in the brown bag. The total number of \$2 notes in the two bags was 15.

- (a) How many \$2 notes were there in the blue bag?
(b) How much money was there in the blue bag?

Ans: (a) _____ [1]

(b) _____ [4]

- 16 Lizan bought 44 stickers at the prices shown below.

Type of sticker	Price per sticker
Big	40 cents
Medium	30 cents
Small	20 cents

She paid a total of \$12.40 for the stickers. The number of big stickers Lizan bought was the same as the number of medium stickers she bought.

- (a) How many small stickers did Lizan buy?
- (b) How much more did Lizan spend on the big stickers than she did on the small stickers?

Ans: (a) _____ [3]

(b) _____ [2]

17 At first, Box M had 18 pears and 42 lemons while Box N had 36 pears and 50 lemons. Then, some lemons were moved from Box M to Box N and some pears were moved from Box N to Box M. In the end, Box M contained pears and lemons in the ratio 3 : 4 while Box N contained pears and lemons in the ratio 1 : 2.

(a) In the end, how many lemons were there in Box M?

(b) In the end, how many more pears did Box N contain than Box M?

Ans: (a) _____ [4]

(b) _____ [1]

- 18 The distance between Town P and Town Q was 216 km. At 07 10, Timothy left Town P for Town Q. At 08 30, Steven left Town Q for Town P. Both did not change their speed throughout. The ratio of Timothy's speed to Steven's speed was 4 : 3. When they met each other, their distance from Town P was twice their distance from Town Q. Find Timothy's speed in km/h.

Ans: _____ [3]

END OF PAPER

YEAR : 2017
LEVEL : PRIMARY 6
SCHOOL : NANYANG PRIMARY
SUBJECT : MATHEMATICS
TERM : PRELIMINARY EXAMINATION

Paper 1

Q1	2	Q4	1	Q7	4	Q10	3	Q13	4
Q2	3	Q5	2	Q8	3	Q11	2	Q14	1
Q3	2	Q6	3	Q9	1	Q12	2	Q15	2

Q16 10

Q17 $\frac{5}{12}$

Q18 $2\frac{1}{4}$ litres

Q19 29

Q20 12:20 pm

Q21 0.03 kg

Q22 110°

Q23

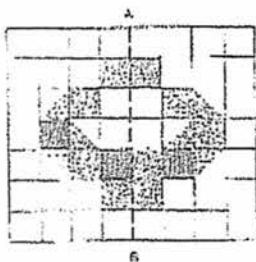

Q24 150 cm

Q25 100 m/min

Q26

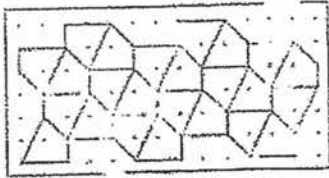

Q27 72 squares

Q28 9 cm

Q29 \$5

Q30 (a & b)

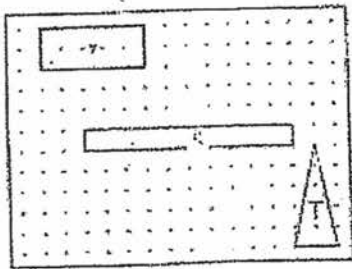

Paper 2

Q1 $\frac{6}{48} \times 100\% \Rightarrow 12\frac{1}{2}\%$

Q2 Total no. of corners $\rightarrow 8$

$$(5 \times 5 \times 5) \times 8 = 1000$$

$$40 \times 30 \times 20 = 24000$$

$$\text{Remaining volume} \rightarrow 24000 - 1000 \Rightarrow \underline{23000 \text{ cm}^3}$$

Q3 (a) Roy's age:

$$6 + (81 - 15) \div 3$$

(b) $81 - 6 - 9 = 66$

$$66 \div 3 = 22$$

$$22 + 6 \Rightarrow \underline{28 \text{ years old}}$$

NANYANG PRELIM

Q4 $11 \times 4 \Rightarrow \underline{44 \text{ cm}}$

Q5 Total $\rightarrow 55 \times 3 = 165$

$A + B + C = 165$

$A \rightarrow 98$

$B \rightarrow 98 \div 2 = 49$

$98 + 49 + C = 165$

$C = 165 - 147 \Rightarrow \underline{18}$

Q6 $10 \div 2 = 5$

$5 \times 3 = 15$

$15 + 5 = 20$

$24 - 20 \Rightarrow \underline{4 \text{ oranges}}$

Q7 1 child $\rightarrow \$n$

3 children $\rightarrow \$n \times 3 = \$(3n)$

Total amount at first $\rightarrow \$(4n + 5) + \$7 + \$(3n)$

$\$7n + \$5 + \$7 \Rightarrow \underline{\$(7n + 12)}$

Q8 $2u = \$0.60$

$1u = \$0.30$

$3u \rightarrow \$0.30 \times 3 \Rightarrow \underline{\$0.90}$

Q9 1st $\rightarrow 100\% - 20\% = 80\%$

2nd $\rightarrow 100\% - 50\% = 50\%$

Total % paid using coupon = $80\% + 50\% = 130\%$

$130\% \rightarrow \$11.70$

$1\% \rightarrow \$\left(\frac{11.70}{130}\right)$

$100\% \rightarrow \$\left(\frac{11.70}{130}\right) \times 100 = \9

$\$9 \times 2 = \18

$\$18 - \$11.70 \Rightarrow \underline{\$6.30}$

Q10 E $\rightarrow 2u$
 F $\rightarrow 2u + 40$
 G $\rightarrow 90$
 H $\rightarrow 120$
 Total = $9u$
 $2u + (2u + 40) + 90 + 120 = 9u$
 $4u + 250 = 9u$
 $5u = 250$
 $u = 50$
 $9u = 50 \times 9 \Rightarrow \underline{450 \text{ ml}}$

Q11 Area of square $\rightarrow 6 \times 6 = 36$
 Area of 1 triangle $\rightarrow 36 \div 4 = 9$
 Area of 2 triangles $\rightarrow 9 \times 2 = 18$

Area of $\frac{3}{4}$ circle $\rightarrow \frac{3}{4} \times \pi \times r \times r$
 $\rightarrow \frac{3}{4} \times \pi \times \sqrt{18} \times \sqrt{18}$
 $\rightarrow \frac{3}{4} \times 3.14 \times \sqrt{18} \times \sqrt{18}$

$\rightarrow 42.39$
 Area of figure $\rightarrow 42.39 + 9 \Rightarrow \underline{51.39 \text{ cm}^2}$

Q12 (a)

Tap X	1min $\rightarrow 2\ell$ 30min $\rightarrow 2 \times 30 = 60\ell$
Tap Y	1min $\rightarrow 3\ell$ 25min $\rightarrow 3\ell \times 25 = 75\ell$
Tap Z	1min $\rightarrow 10\ell$ 10min $\rightarrow 10\ell \times 10 = 100\ell$

Volume of water = $(60 + 75) - 100$
 $= 135 - 100 \Rightarrow \underline{35\ell \text{ or } 35000 \text{ cm}^3}$

(b) Height of water level $\rightarrow \frac{35000}{50 \times 30} \Rightarrow 23\frac{1}{3} \text{ cm}$

Q13 $\angle EHF = \angle GFH = 20^\circ$
 $\angle HEF = \angle HFE = (180^\circ - 20^\circ) \div 2 = 80^\circ$
 $\angle CAH = \angle HCA = (180^\circ - 110^\circ) \div 2 = 35^\circ$
 $\angle CDE = 180^\circ - 80^\circ - 35^\circ \Rightarrow \underline{65^\circ}$

Q14 (a) $12 + 99 = 111$
 $30 \div 2 = 15$
 $15 \times 111 \Rightarrow \underline{1665}$

(b) $30 - 6 \Rightarrow \underline{24}$

Q15 (a) No. of \$2 notes in blue bag $\rightarrow (15 - 5) \div 2 \Rightarrow \underline{5}$

(b) $\frac{3}{4}$ of blue $\rightarrow \frac{2}{3}$ of brown

$\frac{6}{8}$ of blue $\rightarrow \frac{6}{9}$ of brown

No. of notes in blue bag : No. of notes in brown bag
 $8 : 9$

1 unit $\rightarrow 5 - 2 = 3$

8 units $\rightarrow 3 \times 8 = 24$

No. of \$5 notes in blue bag $\rightarrow 24 - 5 = 19$

$(5 \times \$2) + (19 \times \$5) \Rightarrow \underline{\$105}$

- Q16 (a) Let the no. of big stickers be b .
 Let the no. of medium stickers be m .
 Let the no. of small stickers be s .

$$b + m + s = 44$$

$$b + (b) + s = 44$$

$$2b + s = 44 \text{ ---- } \textcircled{1}$$

$$1 \text{ big sticker} \rightarrow 40 \text{ ¢}$$

$$(b) \text{ big stickers} \rightarrow (40 \times b) \text{ ¢} = (40b) \text{ ¢}$$

$$(b) \text{ medium stickers} \rightarrow (30 \times b) \text{ ¢} = (30b) \text{ ¢}$$

$$(s) \text{ small stickers} \rightarrow (20 \times s) \text{ ¢} = (20s) \text{ ¢}$$

$$(40b) \text{ ¢} + (30b) \text{ ¢} + (20s) \text{ ¢} = 1240 \text{ ¢}$$

$$(70b) \text{ ¢} + (20s) \text{ ¢} = 1240 \text{ ¢}$$

$$7b + 2s = 124 \text{ ---- } \textcircled{2}$$

$$2b + s = 44 \text{ ---- } \textcircled{1}$$

$$7b + 2s = 124 \text{ ---- } \textcircled{2}$$

$$\textcircled{1} \times 2 \quad 4b + 2s = 88 \text{ ---- } \textcircled{3}$$

$$\textcircled{2} - \textcircled{3} \quad 3b = 124 - 88$$

$$b = 36 \div 3 = 12$$

$$\text{From } \textcircled{1} \quad 2b + s = 44$$

$$(2 \times 12) + s = 44$$

$$s = 44 - 24 \Rightarrow \underline{20}$$

(b) big stickers $\rightarrow (40 \times b) \text{ ¢}$
 $= (40 \times 12) \text{ ¢}$
 $= 480 \text{ ¢}$
 small stickers $\rightarrow (20 \times s) \text{ ¢}$
 $= (20 \times 20) \text{ ¢}$
 $= 400 \text{ ¢}$

$$\text{Difference} = 480 \text{ ¢} - 400 \text{ ¢} \Rightarrow \underline{80 \text{ ¢} / \$0.80}$$

NUMERICAL PRELIM

Q17 (a) Total pears $\rightarrow 18 + 36 = 54$
 Total lemons $\rightarrow 42 + 50 = 92$
 $12u + 4p = 216$
 $12u + 6p = 276$
 $2p = 276 - 216$
 $2p = 60$
 since $4u + 2p = 92$
 $4u + 60 = 92$
 $4u = 92 - 60$
 $4u \Rightarrow \underline{32 \text{ lemons}}$

(b) Since $4u + 2p = 92$
 $32 + 2p = 92$
 $2u = 92 - 32$
 $2p = 60$
 Pears in N $\rightarrow 1p = 60 \div 2 = 30$
 Pears in M $\rightarrow 3u + p = 54$
 $3u + 30 = 54$
 $3u = 54 - 30 = 24$
 Difference $\rightarrow 30 - 24 \Rightarrow \underline{6 \text{ more pears}}$

Q18 $3u - 2u = 80 \text{ min}$
 $1u = 80 \text{ min}$
 $3u = 80 \times 3 = 240$
 $240 \text{ min} = 4 \text{ h}$
 Distance travelled by Timothy in 4 h $\rightarrow 216 \div 3 \times 2 = 144$
 Timothy's speed $\rightarrow \frac{144}{4} \Rightarrow \underline{36 \text{ km/h}}$

End

