

SA1



**HENRY PARK PRIMARY SCHOOL**  
**SEMESTRAL ASSESSMENT 1 2021**

**PRIMARY 6**

**SCIENCE**

**SECTION A (56 MARKS)**

**INSTRUCTIONS TO CANDIDATES**

1. Do not turn over this page until you are told to do so.
2. Follow all instructions carefully.
3. Answer all questions.
4. Shade your answers on the Optical Answer Sheet (OAS) provided.

Name: \_\_\_\_\_ ( )

Class: Primary 6 ( )

Date: 17 May 2021

Total Time for Booklets A and B: 1 h 45 min

Sections	Marks
A	/ 56
B	/ 44
<b>Total</b>	<b>/ 100</b>

Parent's Signature: \_\_\_\_\_



**Booklet A (56 marks)**

For each question from 1 to 26, four options are given. One of them is the correct answer.

Make your choice (1, 2, 3 or 4) and shade the correct oval (1, 2, 3 or 4) on the Optical Answer Sheet.

1. Mark used the set-up below to measure the volume of gas collected in 30 minutes.

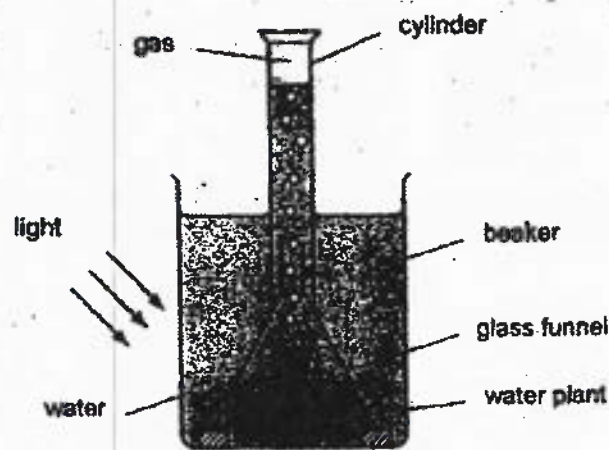

Which change will result in a larger amount of gas collected?

- (1) Adding green colouring to the water.
- (2) Moving the set-up further from the light.
- (3) Putting in a water plant with more leaves.
- (4) Using a plastic funnel instead of a glass funnel.

( )

2. Four test-tubes were set up as shown below and left in the sun for three hours.

The amount of carbon dioxide in the water in each test-tube was the same at the start of the experiment.

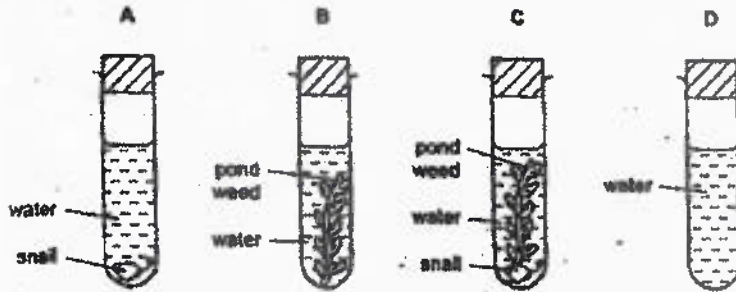

Substance X is added to each test-tube to test for the presence of carbon dioxide in water. Substance X turns orange when there is an increase in the amount of carbon dioxide.

In which test-tube(s) would substance X turn orange?

- (1) A only
- (2) B only
- (3) A and D only
- (4) B and C only

( )

3. The table shows the approximate composition of four gases in inhaled and exhaled air.

Gas	Percentage of gas in	
	inhaled air	exhaled air
P	0.01	0.04
Q	0.04	4
R	21	16
S	78	78

What is gas S likely to be?

- (1) oxygen
- (2) nitrogen
- (3) water vapour
- (4) carbon dioxide

( )

4. The diagram shows how food and various gases are transported in the human body.

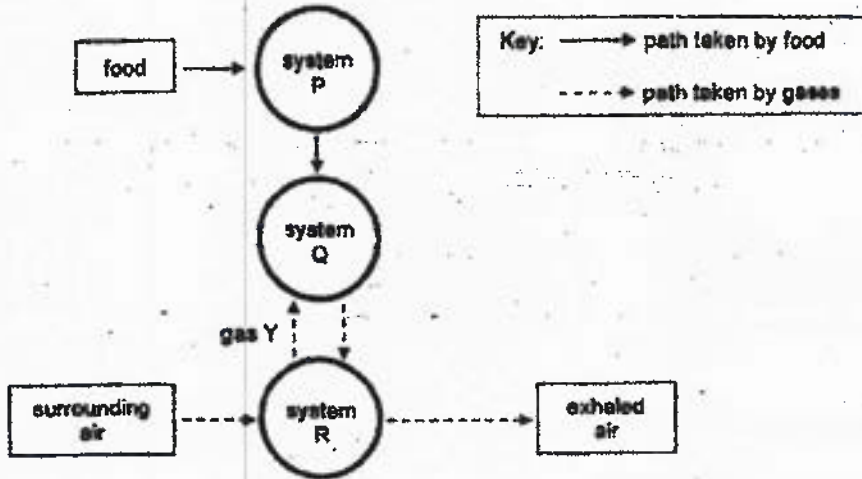

Which systems do P, Q and R represent and what is gas Y?

	System P	System Q	System R	Gas Y
(1)	circulatory	respiratory	digestive	carbon dioxide
(2)	digestive	respiratory	circulatory	carbon dioxide
(3)	circulatory	digestive	respiratory	oxygen
(4)	digestive	circulatory	respiratory	oxygen

5. Study the concept map below carefully.

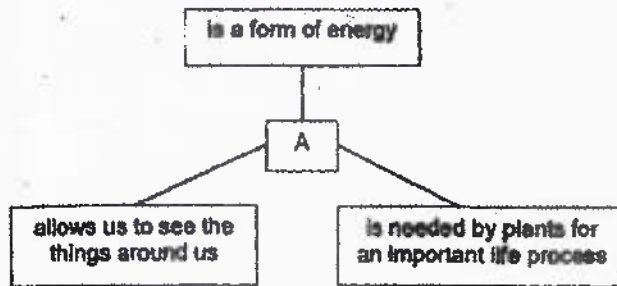

What will happen to a plant if A is missing?

- (1) It cannot carry out photosynthesis.
- (2) It cannot take in water from the soil.
- (3) It cannot undergo pollination and fertilisation.
- (4) It cannot exchange gases with the surroundings.

( )

6. The diagram shows the cross-section of a stem.

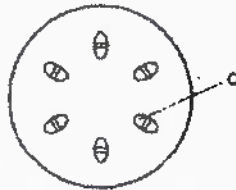

Part Q turns blue when the stem is placed in blue-coloured water for two days.

What is the function of Q?

- (1) To absorb water from the roots.
- (2) To absorb food from the leaves.
- (3) To transport water from the roots.
- (4) To transport food from the leaves.

( )

7. The diagram below shows the dispersal of seeds by plants P, Q and R.

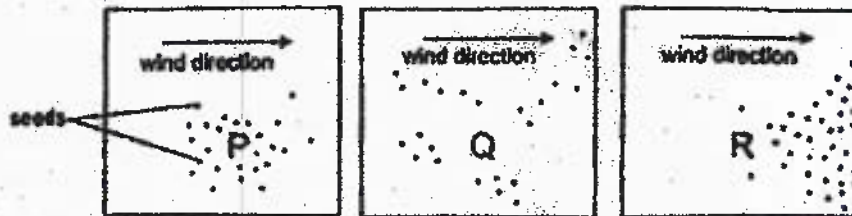

Which of the following shows correctly how plants P, Q and R are dispersed?

	Plant P	Plant Q	Plant R
(1)	animal	animal	explosive action
(2)	explosive action	animal	wind
(3)	animal	explosive action	wind
(4)	explosive action	explosive action	animal

8. The diagram below shows a flowering plant at different stages.



Stage 1



Stage 2



Stage 3

What are the conditions needed at all three stages?

- (1) air and light
- (2) air and water
- (3) warmth and oxygen
- (4) carbon dioxide, water, light

9. The diagram below shows cell G.

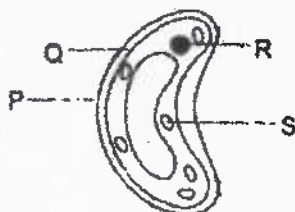

Which part controls the movement of substances in and out of cell G?

- (1) P
- (2) Q
- (3) R
- (4) S

( )

10. The diagram below shows the types of organisms found along a stretch of river near a factory.

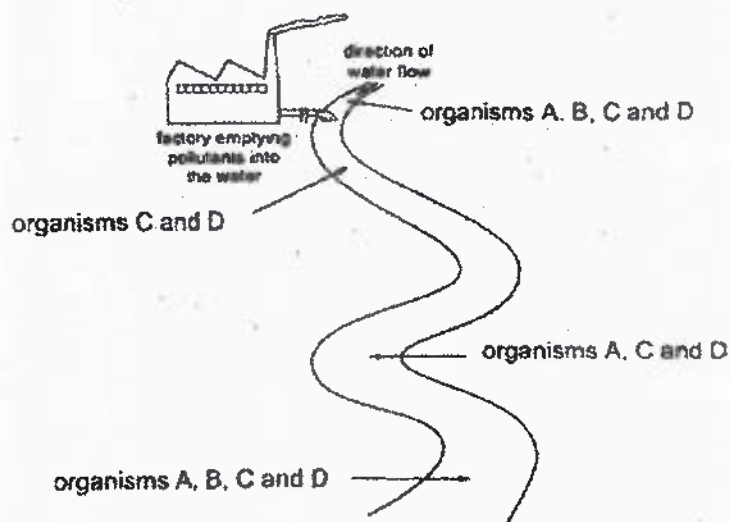

Based on the information given, which organism(s) can live in the most polluted water?

- (1) A only
- (2) C only
- (3) A and B only
- (4) C and D only

( )



11. For the past 10 years, the amount of carbon dioxide in the Earth's atmosphere has increased significantly.

Which of the following actions could cause the increase in carbon dioxide?

- A soil erosion
- B deforestation
- C rise in sea level
- D burning of fossil fuels

- (1) A and C only
- (2) B and D only
- (3) A, C and D only
- (4) B, C and D only

( )

12. Worms come to the soil surface after a heavy rain. Which characteristic of living things does this show?

- (1) Living things die.
- (2) Living things grow.
- (3) Living things reproduce.
- (4) Living things respond to change.

( )

13. Study the flowchart below carefully.

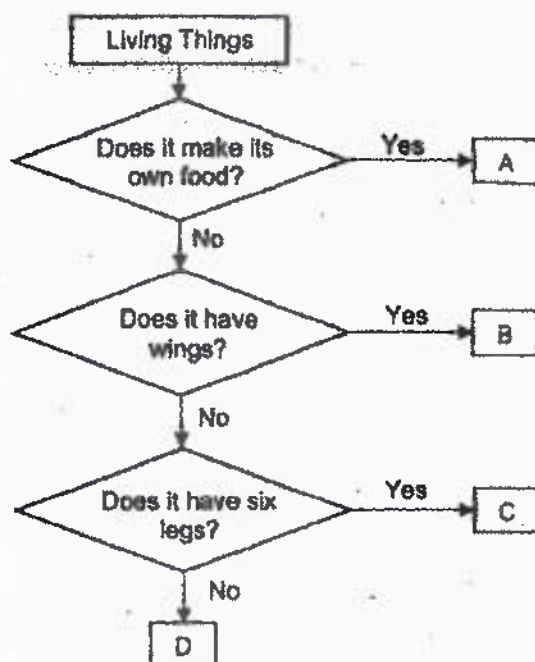

The diagram below shows living thing X which is found in a garden.



Living thing X

Where could living thing X be placed in the flowchart above?

- (1) A
- (2) B
- (3) C
- (4) D

( )

14. The diagram shows a structure at sea.  
The waves at sea cause part B to move up and down which generates electricity.

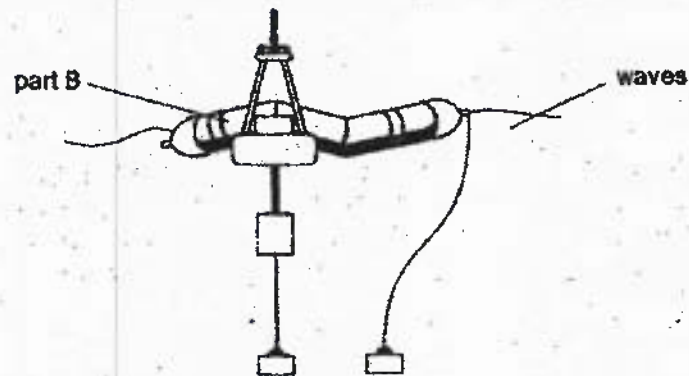

Based on the information given, which of the following is/are correct?

- A Waves are a non-renewable source of energy.
  - B Generating electricity in this way does not release greenhouse gases into the environment.
  - C The structure will not be able to generate the same amount of electricity all the time.
- (1) B only  
 (2) A and C only  
 (3) B and C only  
 (4) A, B and C

( )

15. Four identical wet towels are hung out to dry outdoors in different locations as shown in the diagrams below.

Which towel dries most quickly?

(1)

cloudy, windy

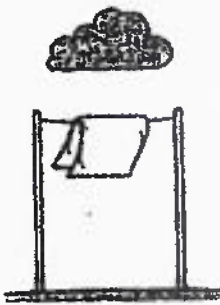

(2)

sunny, windy

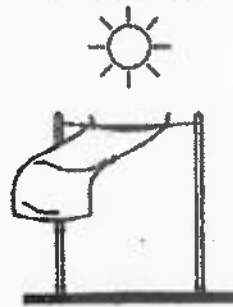

(3)

sunny

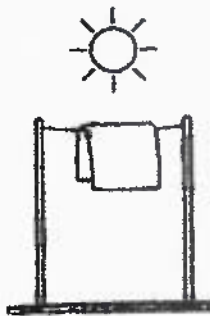

(4)

cloudy

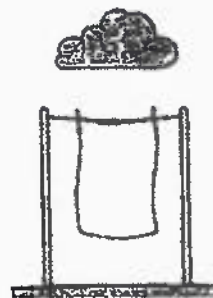

( )

16. The diagram shows an aeroplane on a runway. The aeroplane is at rest at A. It moves to B before taking off into the sky at C.

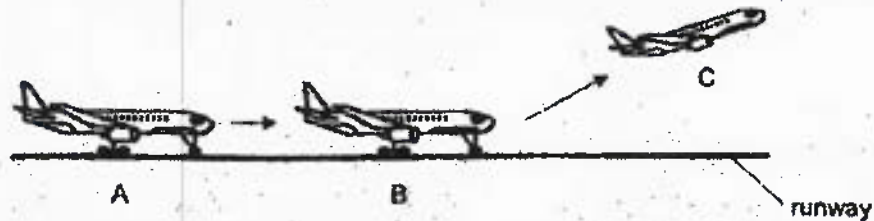

At which position(s) is/are gravity acting on the plane?

- (1) C only
  - (2) A and B only
  - (3) B and C only
  - (4) A, B and C
- ( )
17. Which of the following correctly shows the similarity or difference between boiling and evaporation?
- (1) Both boiling and evaporation require direct heating.
  - (2) Both boiling and evaporation take place at a fixed temperature.
  - (3) The liquid gains heat during boiling but no heat is gained during evaporation.
  - (4) Boiling takes place throughout the liquid while evaporation takes place at the surface of the liquid.
- ( )

18. Julia poured equal amount of hot water at the same temperature into two containers, A and B, made of the same material. She placed a thermometer in each container to measure the temperature of the water as shown in the diagram below.

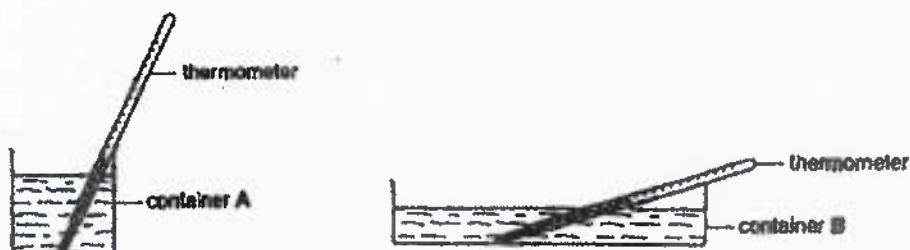

Julia recorded the temperature of the water in each container over 10 minutes.

Which graph correctly shows the changes in temperature over 10 minutes?

(1)

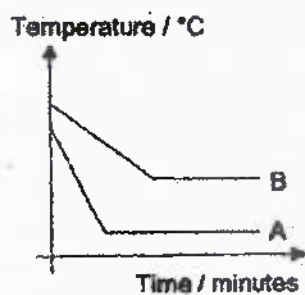

(2)

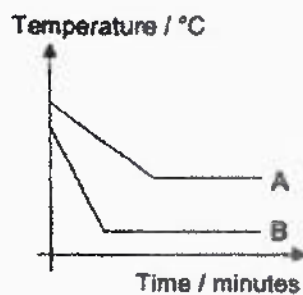

(3)

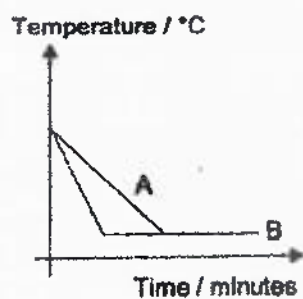

(4)

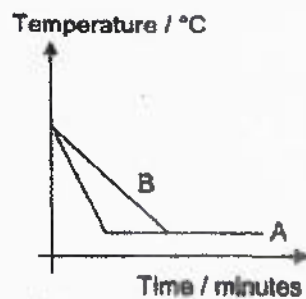

( )

19. Study the set-up below.

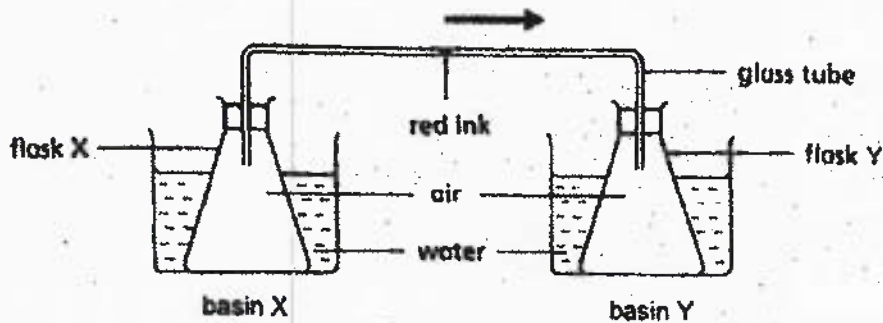

For the red ink to move towards flask Y in the shortest time, what should be the temperature of the water in the two basins?

	Temperature of water in basin X ( $^{\circ}\text{C}$ )	Temperature of water in basin Y ( $^{\circ}\text{C}$ )
(1)	35	50
(2)	50	95
(3)	50	35
(4)	95	50

20. A water tank used for flushing a toilet bowl is shown below. The flushing and re-filling system is not shown in the diagram. After flushing, water enters and re-fills the tank.



James wanted to use less water to flush the toilet bowl. He put a plastic bottle with stones into the water tank.

Which property of matter does this show?

- (1) Matter has mass.
- (2) Matter sinks in water.
- (3) Matter takes up space.
- (4) Matter can be compressed.

21. The diagram below shows a set-up that uses four identical lamps to heat food. When the lamps are brighter, they give out more heat.

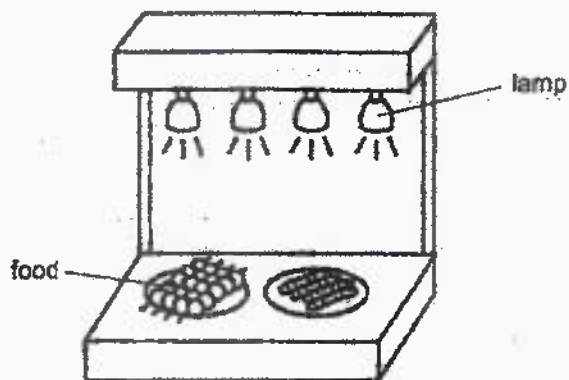

In which of the following circuits will the lamps give out the most heat?

(1)



(2)



(3)

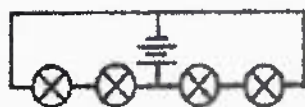

(4)



( )



22. In the set-up below, the bar magnet is repelled by the electromagnet. A pointer attached to the spring moves when the circuit is closed.

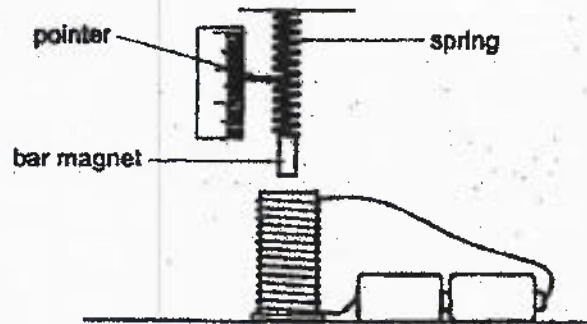

How will the pointer move when one more battery is added? Why?

	Movement of the pointer	Strength of the electromagnet
(1)	upwards	increases
(2)	upwards	decreases
(3)	downwards	increases
(4)	downwards	decreases

23. Natalie placed a hot boiled egg in a glass container of cold water.



Which of the following correctly shows the flow of heat?

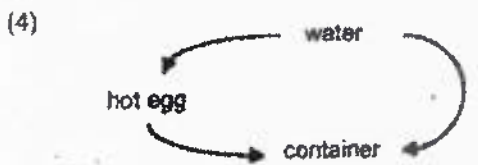
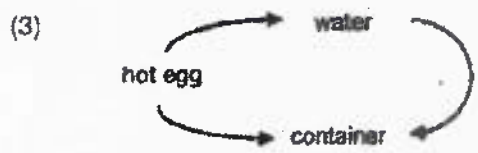
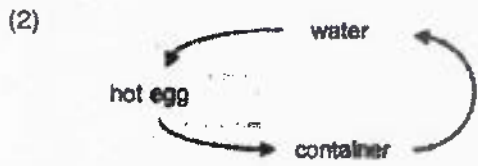
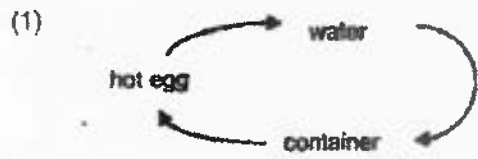

( )

24. An experiment was conducted to investigate whether light can pass through four sheets, A, B, C and D, made of different materials. The sheets were arranged in two set-ups P and Q as shown.

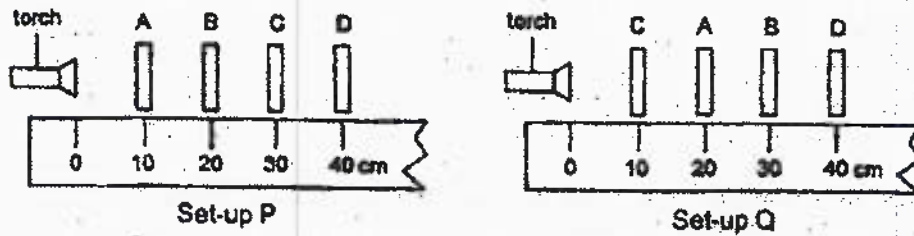

The distance travelled by the light for each set-up was measured and the results are shown in the chart below.

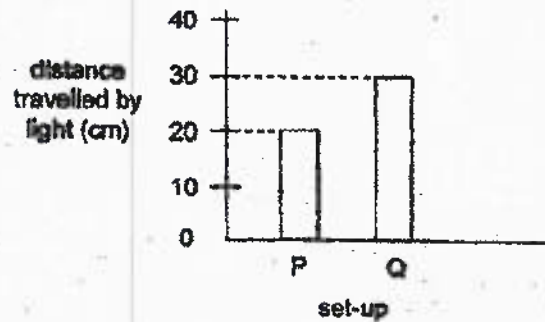

Which one of the following correctly describes sheets A, B, C and D?

Does it allow light to pass through?				
	A	B	C	D
(1)	no	not sure	yes	no
(2)	yes	no	yes	not sure
(3)	not sure	yes	no	yes
(4)	yes	no	not sure	no

25. Which of the following statement(s) describe(s) the volume of an object?

- A The volume of an object is the amount of space it takes up.  
 B The volume of an object can be measured using a weighing scale.  
 C The volume of an object increases when an object gains heat and expands.

- (1) B only  
 (2) A and C only  
 (3) B and C only  
 (4) A, B and C

( )

26. Jason recently purchased four magnets. In order to find out which is the strongest magnet, he prepared the set-up shown below.

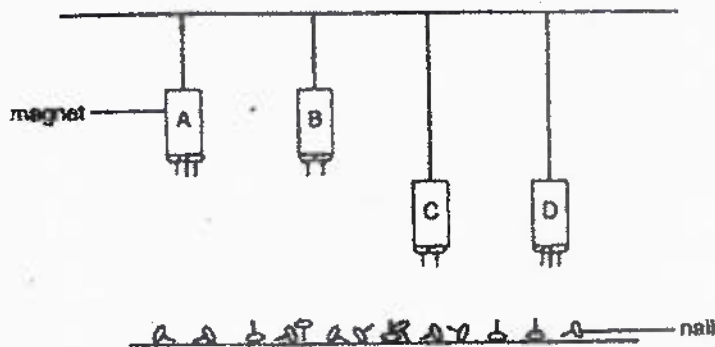

From the results given, which one of the following best describes the strength of the magnets above?

	Strongest	Weakest	Not possible to tell
(1)	C	D	A, B
(2)	A	C	B, D
(3)	B	A	C, D
(4)	D	B	A, C

( )

27. The diagram below shows a round glass bowl. A metal ball was held at P. When the ball was released, it rolled down.

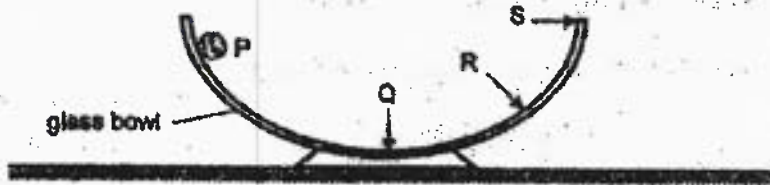

Which of the following is the most likely path of the ball after it was released?

- (1) S and out of the bowl
- (2) S and then rolled back
- (3) R and then rolled back
- (4) Q and then rolled back

( )

28. Study the circuit below. Bulbs A and B, and the three batteries are identical. At first, bulb A is unlit while bulb B is lit with a brightness of 10 units.

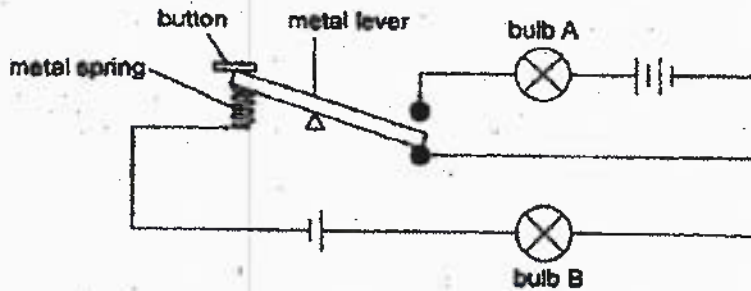

If the button is pressed and held down, what would happen to bulbs A and B?

	bulb A	bulb B
(1)	as bright as 10 units	unlit
(2)	brighter than 10 units	unlit
(3)	as bright as 10 units	brighter than 10 units
(4)	brighter than 10 units	brighter than 10 units

( )

End of Booklet A



**HENRY PARK PRIMARY SCHOOL  
SEMESTRAL ASSESSMENT 1 2021**

**PRIMARY 6**

**SCIENCE**

**SECTION B (44 MARKS)**

**INSTRUCTIONS TO CANDIDATES**

1. Do not turn over this page until you are told to do so.
2. Follow all instructions carefully.
3. Answer all questions.

Name: \_\_\_\_\_ ( )

Class: Primary 6 ( )

Date: 17 May 2021

Total Time for Booklets A and B: 1 h 45 min

Marks for Section B: \_\_\_\_\_

**Booklet B (44 marks)**

For questions 29 to 41, write your answers in this booklet:

The number of marks available is shown in brackets [ ] at the end of each question or part question.

29. The diagram shows plant cells M and N.

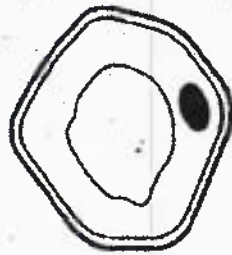

Cell M

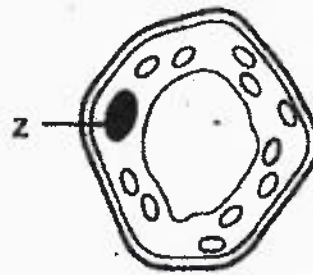

Cell N

- (a) Which cell, M or N, is able to carry out photosynthesis? [1]

Explain your answer.

---



---

- (b) Name part Z and state its function. [1]

---



---



30. A group of students used an aquatic plant to investigate the effect of temperature on the rate of photosynthesis.

The set-up is shown below.

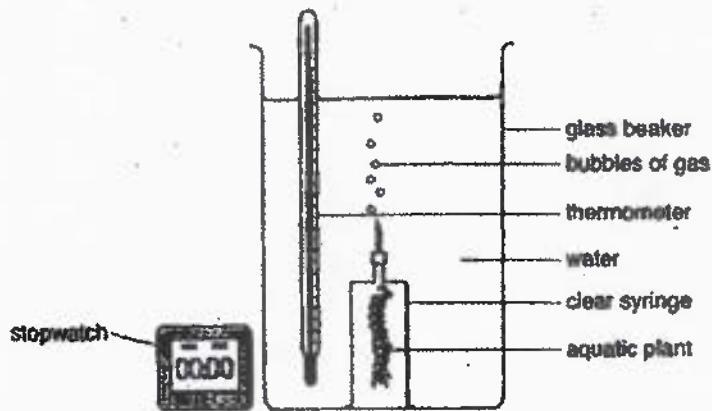

The students counted the number of bubbles of gas the aquatic plant produced in two minutes at different temperatures.

The graph shows their results.

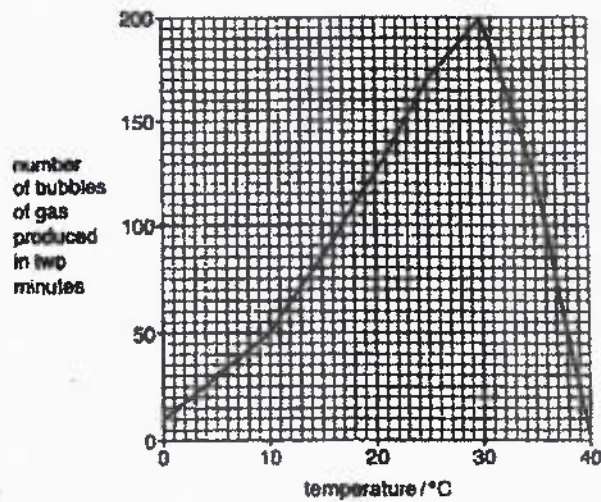



Question 30 continued

- (a) In the table shown below, tick (✓) the variables that the students should keep the same. [1]

Tick (✓)	Variable
	Type of aquatic plant
	Bubbles of gas
	Temperature of water
	Duration of experiment

- (b) Using the information from the graph, describe how the temperature affects the rate of photosynthesis. [1]

---



---

Another factor that affects the rate of photosynthesis is light.

The amount of light that passed through three materials are recorded in the table below.

Material	Amount of light passed through / units
P	200
Q	0
R	50

- (c) State which material is most suitable for making a greenhouse for growing plants. [2]  
Explain your answer.

---



---



31. The human body is made up of different organ systems working together.

(a) State the main function of the human circulatory system. [1]

---



---

(b) The diagram shows how blood flows in certain parts of the human body.

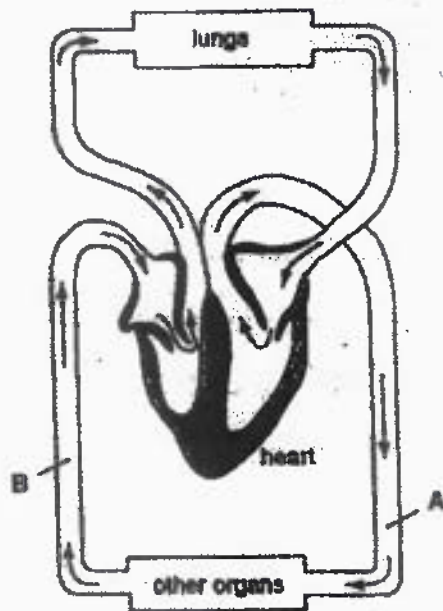

(i) State a difference between the blood in A and the blood in B. [1]

---



---

(ii) Explain your answer in (b)(i). [1]

---



---



32. The diagram shows insect P visiting a flower of plant X.

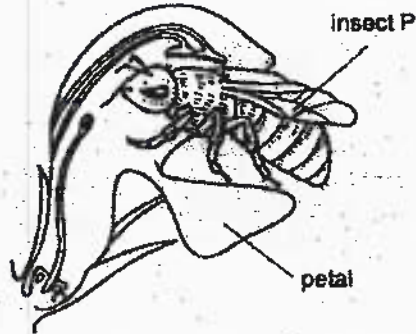

(a) Describe how insect P helps the flower to develop into a fruit. [1]

---

---

(b) Suggest two features of the flower that attracted insect P to the flower. [1]

---

---

The diagram shows parts A and B of the fruit of plant X.

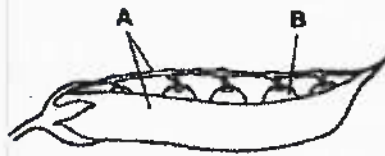

(c) Name the parts of the flower from which parts A and B have developed. [1]

Part A: \_\_\_\_\_ Part B: \_\_\_\_\_



33. Plant M has leaves that are white at the edges. Part of a leaf of plant M was covered with a thick black paper and the plant was placed in the dark for 2 days.

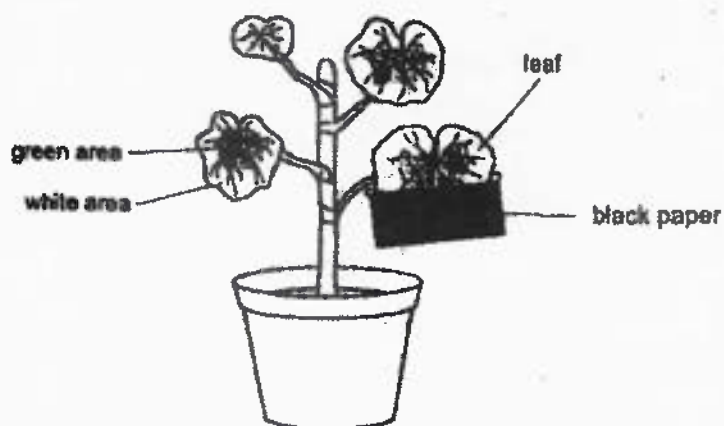

After 2 days, the plant was placed under the sun for 12 hours before the thick black paper was removed from the leaf. The leaf was tested for the presence of starch.

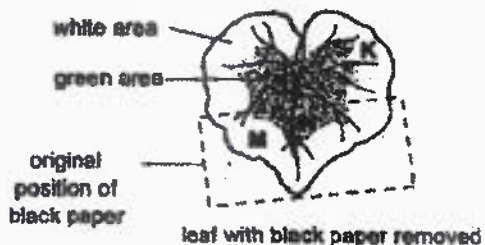

- (a) Predict which areas of the leaf will contain starch after 12 hours. Put a tick (✓) if starch is present. [1]

Area	Tick (✓)
K	
L	
M	
N	

- (b) Explain your answer for Area K. [1]

---



---



34. Stomata are tiny openings found mostly on the underside of leaves. They control water loss by opening and closing.

(a) State another function of the stomata.

[1]

Ravi investigates the effect of temperature on the movement of water through a plant. He sets up the apparatus shown in the diagram below.

Ravi carries out the following steps.

1. He records the position of the air bubble at the start of the experiment.
2. He leaves the set-up at a low temperature for 10 minutes and records the new position of the air bubble.
3. He repeats the steps at a high temperature.

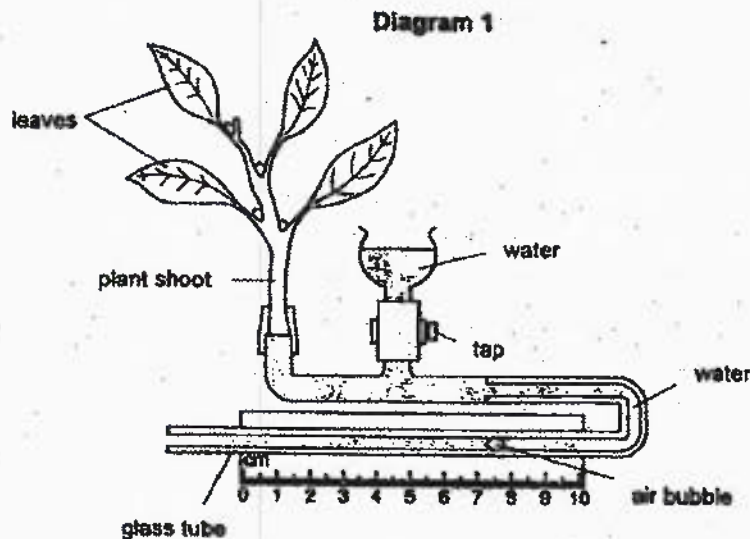

The movement of the air bubble in the set-up shows the amount of water taken in by the shoot. The table shows the results that Ravi has obtained.

Temperature	Position of bubble at the start (cm)	Position of bubble after 10 minutes (cm)	Distance moved by bubble (cm)
Low (trial 1)	2.2	3.7	1.5
Low (trial 2)	3.8	5.2	1.6
High (trial 1)	3.8	7.1	3.3



## Question 34 continued

The diagram shows the position of the air bubble at the start for trial 2 set at high temperature and its position after 10 minutes.

## Position of air bubble at high temperature (trial 2)

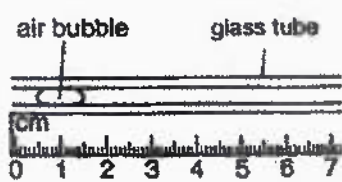

Position at the start

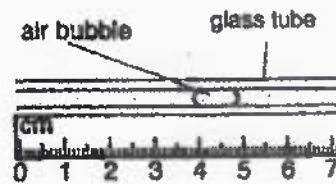

Position after 10 minutes

- (b) Study the values given below.

Based on the positions of the air bubble shown above, state the distance moved by the air bubble by circling the correct value. [1]

2.5 cm

3.4 cm

4.9 cm

- (c) Suggest why the amount of water taken in by the shoot may not be the same as the amount of water lost by the shoot. [1]

---



---

- (d) Ravi removes three leaves from the plant shoot shown in diagram 1. He observed that now the air bubble moves slower. [1]  
Give a reason for this observation.

---



---



35. Mala wanted to find out whether germinating seeds produce heat. She sets up the experiment as shown in the diagram below. The temperature of the seeds in both flasks at the start of the experiment is  $18^{\circ}\text{C}$ .

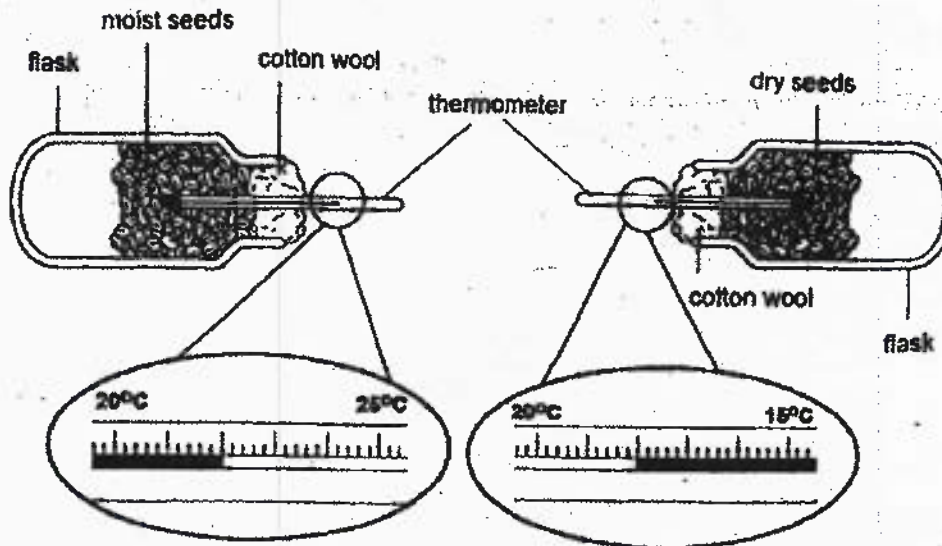

Temperatures recorded at the end of the experiment

- (a) How did Mala ensure that only the seeds in one flask germinate?  
Explain your answer.

[1]

---



---

- (b) Suggest why cotton wool was used rather than a rubber stopper in each flask.

---



---

- (c) Based on the results given, what can Mala conclude from the experiment?  
Explain your answer.

[2]

---



---



36. The diagram shows nuts with outer coverings called shell. The shell is inedible.

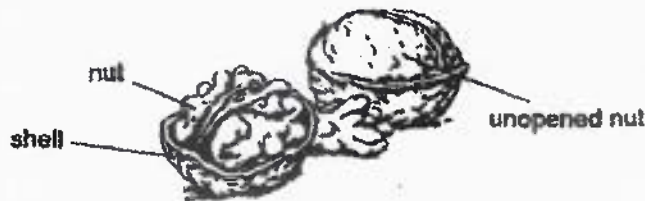

Animal C feeds on the nut. However, it is unable to break the shell by squeezing it between its beak.

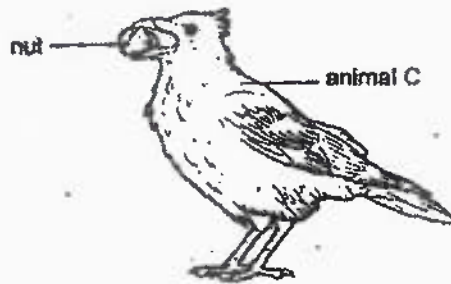

(a) Which property of the shell is observed above? [1]

\_\_\_\_\_

In order to break the shell, animal C flies off with the nut in its beak. Animal C then drops the nut on the road which causes the shell to break.

(b) Fill in the boxes below to show the energy conversion as animal C drops the nut. [2]



(c) If the shell does not break, animal C will fly even higher with the nut before dropping it. How does this help Animal C to crack the shell? [1]

\_\_\_\_\_

\_\_\_\_\_





37. Diagram 1 shows the experimental set-up Melvin used to investigate the effects of force on the extension of two different springs, A and B.

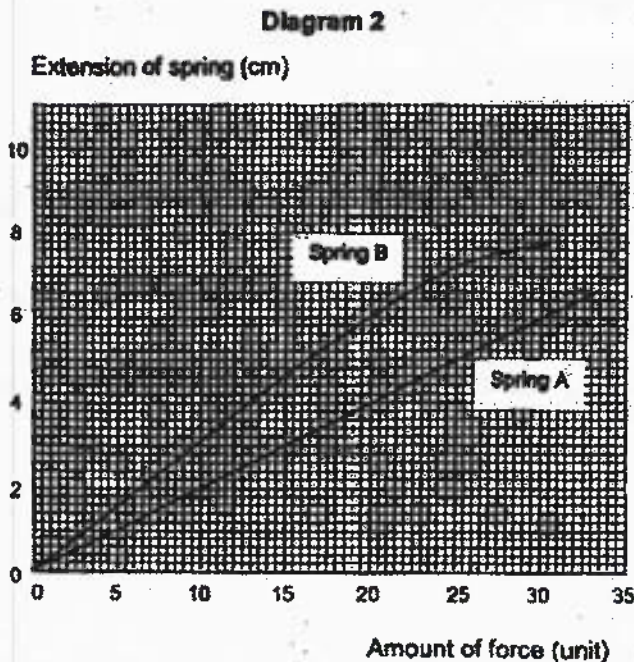
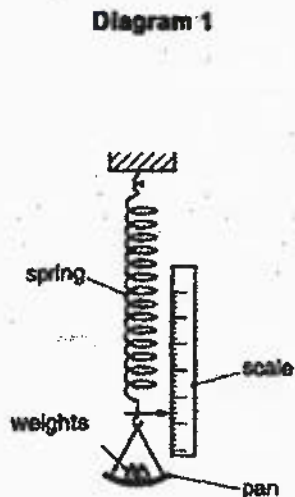

The graph in diagram 2 shows the extension of springs A and B when the weights are added.

(a) Explain the purpose of adding weights to the set-up. [1]

---



---

(b) Melvin concluded that spring B is easier to stretch than spring A. Use the results from the graph to explain whether Melvin is correct. [1]

---



---



Question 37 continued

Melvin used spring A to build a launcher shown in the diagram below.

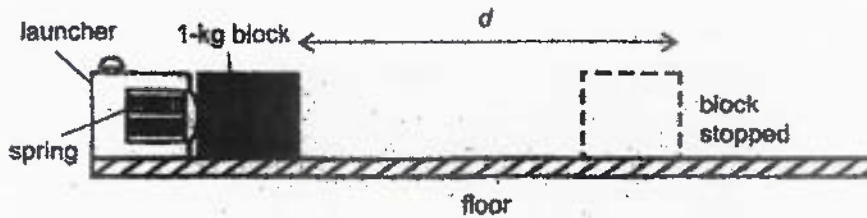

He pushed a 1-kg block towards the launcher and released it. The block moved by a distance  $d$  before stopping.

Melvin repeated the experiment using similar blocks of different mass. His results are shown in the table below.

Mass of block (kg)	$d$ (cm)
1	30
2	22
3	13
4	5
5	3

(c) Based on the results, how does the mass of the block affect the distance moved by it? [1]

---



---

Melvin conducted the experiment with a 10-kg block. He observed that the block did not move at all.

(d) Explain why the 10-kg block did not move. [1]

---



---



Question 37 continued

Steel springs are found in a battery holder as shown below.

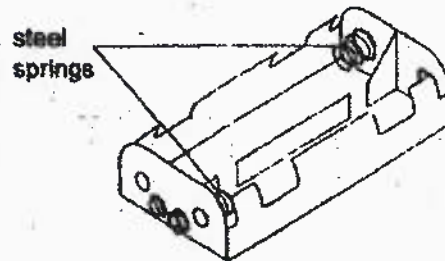

Melvin inserted batteries into the battery holder and connected it as shown in the circuit diagram below.



(e) How do the steel springs in the battery holder help it to function properly?

[1]

---

---



38. The diagram shows a Solar Still.

Seawater is poured into the Solar Still and the Solar Still is left floating on the sea. After some time, pure water is collected in part R.

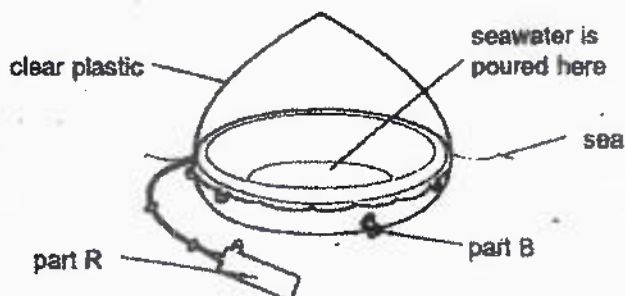

The picture below shows the cross-section of the Solar Still.



- (a) Based on the information given, describe how the Solar Still is able to collect pure water from the seawater. [2]

---



---



---

- (b) The container that holds the seawater in a Solar Still is usually made of steel. Explain why steel container is more suitable than a plastic container for holding seawater in a Solar Still.

---



---



39. A drink seller placed cans of drinks at room temperature into a box full of ice as shown in Diagram 1.

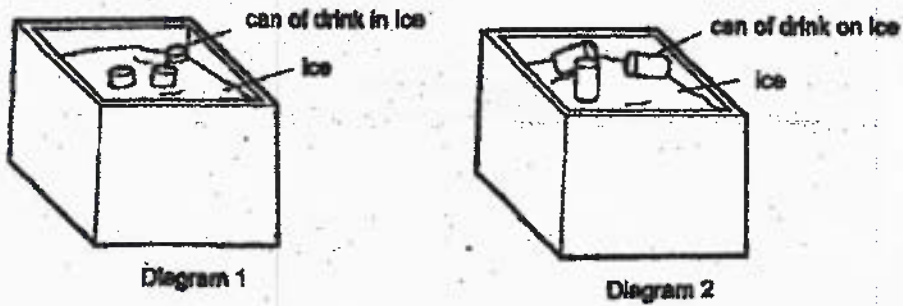

- (a) Explain why the cans of drinks cooled down after some time. [2]

---



---



---

- (b) Which method, diagram 1 or 2, will cool the cans of drinks faster? [2]  
Give a reason for your answer.

---



---



40. Reina investigates how quickly heat is conducted through four different metals. The diagram shows the experimental set-up used.

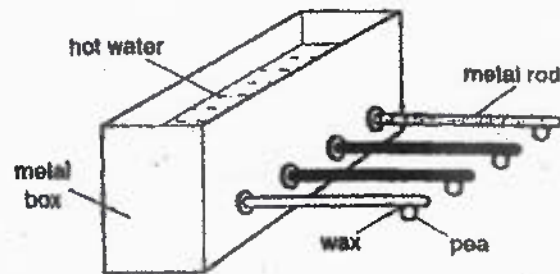

Each of the four metal rods have one end fixed into the metal box. Each rod has a pea attached to it by wax.

- (a) Describe what happens to the wax and to the pea on the metal rods after a while. [1]

---



---

- (b) State how the experimental set-up helps to identify which of the four metals is the best conductor of heat. [1]

---

Reina's teacher wants her to improve the experimental set-up. She suggests placing several peas along each rod, as shown below.

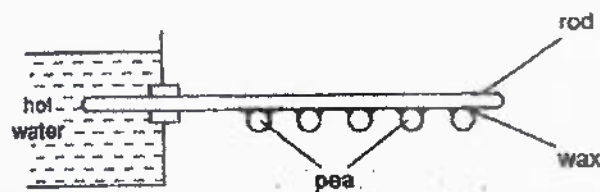

- (c) Explain how the improved set-up gives a better comparison of how quickly heat passes through the four metals. [1]

---



---



41. The diagram shows a ceiling light with three bulbs found in a restaurant.

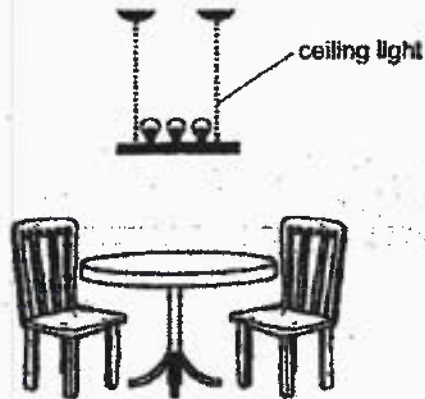

Simon noticed that when any one of the bulbs are removed, the rest of the bulbs were no longer lit.

- (a) Using only wires, complete the circuit below to show how the three bulbs are connected. [2]

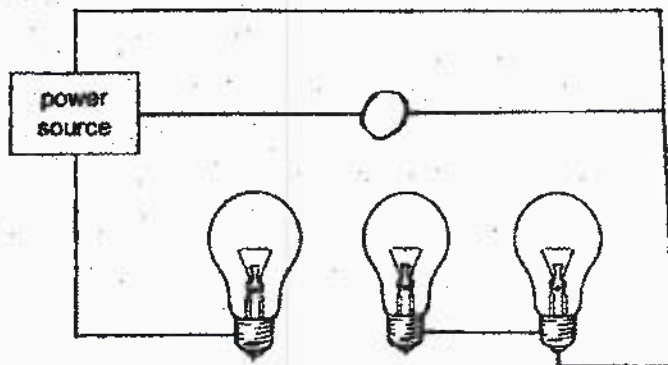

Simon wanted to add another bulb to the ceiling light such that the new light bulb will continue to be lit even when any one of the other bulbs are removed.

- (b) Add another bulb to your circuit in part (a) to show how Simon can do this. [1]  
(Note: Use the symbol for bulb in your drawing)

End of Booklet B







**EXAM PAPER 2021**

**LEVEL** : **PRIMARY 6**  
**SCHOOL** : **HENRY PARK PRIMARY**  
**SUBJECT** : **SCIENCE**  
**TERM** : **SA1**

**BOOKLET A**

<b>Q1</b>	<b>Q2</b>	<b>Q3</b>	<b>Q4</b>	<b>Q5</b>	<b>Q6</b>	<b>Q7</b>
3	1	2	4	1	3	2
<b>Q8</b>	<b>Q9</b>	<b>Q10</b>	<b>Q11</b>	<b>Q12</b>	<b>Q13</b>	<b>Q14</b>
2	2	4	2	4	3	3
<b>Q15</b>	<b>Q16</b>	<b>Q17</b>	<b>Q18</b>	<b>Q19</b>	<b>Q20</b>	<b>Q21</b>
2	4	4	3	4	3	4
<b>Q22</b>	<b>Q23</b>	<b>Q24</b>	<b>Q25</b>	<b>Q26</b>	<b>Q27</b>	<b>Q28</b>
1	3	2	2	2	3	4

**BOOKLET B**

**Q29 a)** Cell N is able to carry out photosynthesis. Cell N has chloroplasts which contain chlorophyll to taken in sunlight for photosynthesis.

**b)** Nucleus. The nucleus controls all activity going on within the cell.

**Q30 a) i)** Type of aquatic plant

**ii)** Duration of experiment

**b)** When the temperature increases from 0 to 30, the rate of photosynthesis increases. When the temperature increases from 30 to 40, the rate of photosynthesis decreases.

**c)** Material P. It is a transparent material which will allow the most sunlight to pass through the greenhouse, ensuring that the growing plants will be able to take in maximum sunlight for photosynthesis. So the rate of photosynthesis increased.

- Q31 a) It is to transport blood rich in oxygen and digested food to all parts of the body. It will also transport blood rich in carbon dioxide back to the lungs for the carbon dioxide to be removed.
- b) i) The blood in A contains more oxygen while the blood in B contains less oxygen.  
ii) The blood will take oxygen from the lungs, which will be pumped by the heart to all parts of the body.
- Q32 a) Insect P will transfer the pollen from the anther of the flower of plant X to the stigma of another flower, helping to pollinate it. After that, the flower will be able to fertilize and become a fruit.
- b) The flower has colourful petals and produces a sweet scent.
- c) Part A: Ovary                      Part B: Ovules
- Q33 a) Area L  
b) Area K is a white area, which does not have chlorophyll to trap light for photosynthesis to take place.
- Q34 a) The stomata allow gaseous exchange to take place.  
b) Ans: 3.4cm  
c) When the plant is photosynthesizing, the amount of water taken in may not be the same.  
d) When the three leaves are removed, there will only be one leaf to photosynthesis and make food. Therefore, it will need less water and the shoot will not absorb a lot of water, thus the air bubble moves slower.

- Q35** a) There is moisture in the first flask, allowing the seeds to germinate. The seeds in the other flask has no water, thus they cannot germinate. In the end, only the seeds in the first flask germinated.
- b) The cotton wool allows oxygen to enter the flask, but rubber does not allow oxygen to enter.
- c) Mala can conclude that germinating seeds produced heat. The temperature in the flask with moist seeds increased while the temperature in the flask with dry seeds decreases.
- Q36** a) The shell is strong.
- b) Nut - gravitational potential energy  $\longrightarrow$   
 Nut - Kinetic energy  $\longrightarrow$   
 Shell - sound energy + Kinetic energy
- c) The gravitational potential energy will increase and converted to more kinetic energy causing the impart to increase, thus, helping animal C to crack the shell.
- Q37** a) The weights exert a force that causes the spring to stretch.
- b) Melvin's conclusion is correct. For the same amount of force exert on each spring, B's extension is longer.
- c) As the mass of the block increases, the distance moved by it decreases.
- d) The elastic spring force exerted by the spring could not overcome the frictional force between the block and the floor.
- e) The spring pushed the battery against the metal contacts so that there was a closed circuit.
- Q38** a) The seawater will gain heat and evaporate to form water vapour, which will rise and come in contact with the water surface of the clear plastic, lose heat and condense to form water droplet. The water droplets will slide down into part R.

b) Steel is a better conductor of heat to allow the seawater to gain heat faster and evaporate faster, making it more suitable than a plastic container.

Q39 a) The temperature of the can is higher than the ice. The cans of drinks will lose heat to the ice, allowing them to cool down after some time.

b) Diagram 1. Since the cans of drinks are in ice, there is more contact area between the ice and the drinks, allowing the drinks to lose heat to the ice faster.

Q40 a) The wax will melt and the pea will drop after a while.

b) The pea that drops first makes the material the best conductor of heat.

c) The peas are closer to the hot water so results can be observed more quickly.

Q41 a)

b)

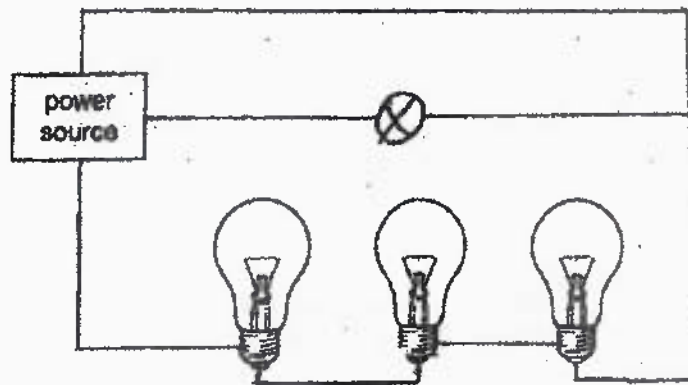

4  
END