

SA2



NANYANG PRIMARY SCHOOL
PRIMARY 6 SCIENCE
PRELIMINARY EXAMINATION
2021

BOOKLET A

Duration for Booklets A and B: 1 h 45 min

Name: _____ . ()

Class: Primary 6 ()

**DO NOT OPEN THIS BOOKLET UNTIL YOU ARE TOLD TO DO SO.
FOLLOW ALL INSTRUCTIONS CAREFULLY.**

Booklet A consists of 19 printed pages including this cover page.

Section A: Multiple Choice Questions [56 marks]

For each question from 1 to 28, four options are given. One of them is the correct answer. Indicate your choice in this booklet and shade the correct oval (1, 2, 3 or 4) on the Optical Answer Sheet provided.

1. The diagram below represents a life process that takes place in green plants on a bright day.

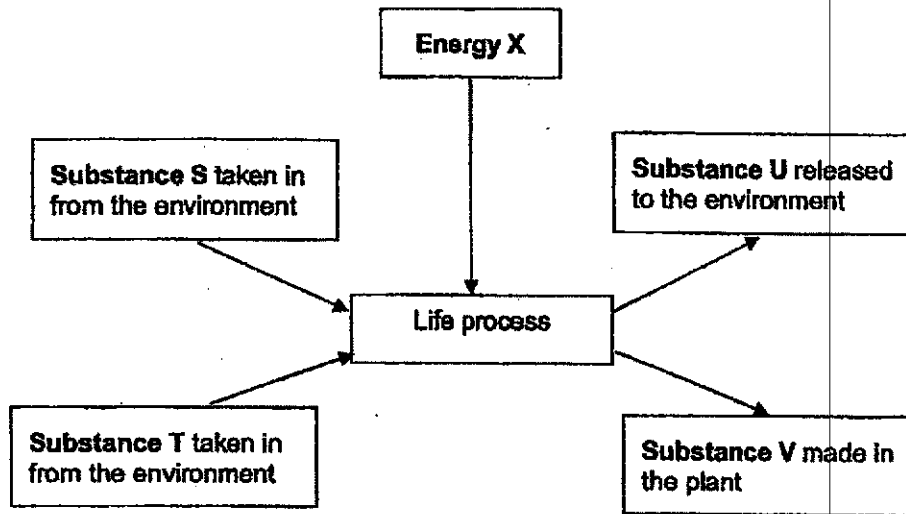

Which one of the following correctly identifies S, T, U, V and X?

	Substance				Energy X
	S	T	U	V	
(1)	oxygen	water	carbon dioxide	sugar	heat
(2)	oxygen	sugar	carbon dioxide	water	light
(3)	carbon dioxide	sugar	oxygen	water	heat
(4)	carbon dioxide	water	oxygen	sugar	light

2. Containers, A, B and C, were set up with the same amount of carbon dioxide at the start of an experiment. For 12 hours, containers A and B were kept in the presence of light while container C was kept in darkness.

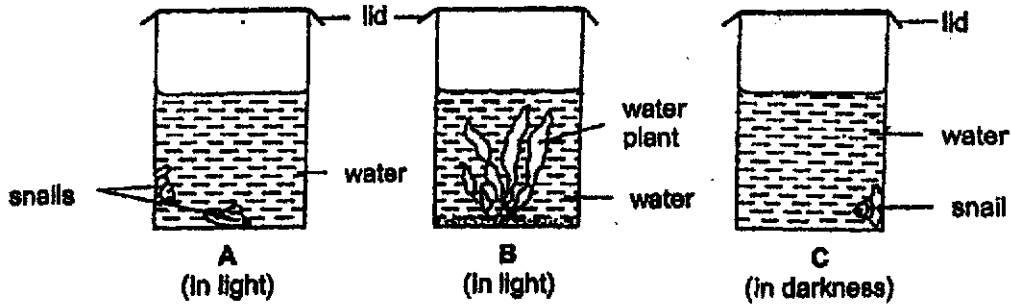

Which one of the following shows the containers arranged according to the amount of carbon dioxide in them at the end of the experiment?

	least carbon dioxide	→	most carbon dioxide
(1)	A	,	B , C
(2)	B	,	A , C
(3)	B	,	C , A
(4)	C	,	A , B

3. The diagram below shows a flower.

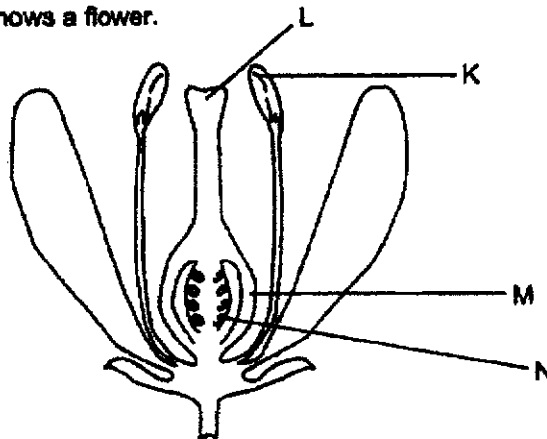

Which of the following is correct after pollination and fertilisation have taken place?

	Develops into a seed	Develops into a fruit
(1)	K	L
(2)	L	K
(3)	M	N
(4)	N	M

4. Ralph observed two fruits, R and S, as shown below.

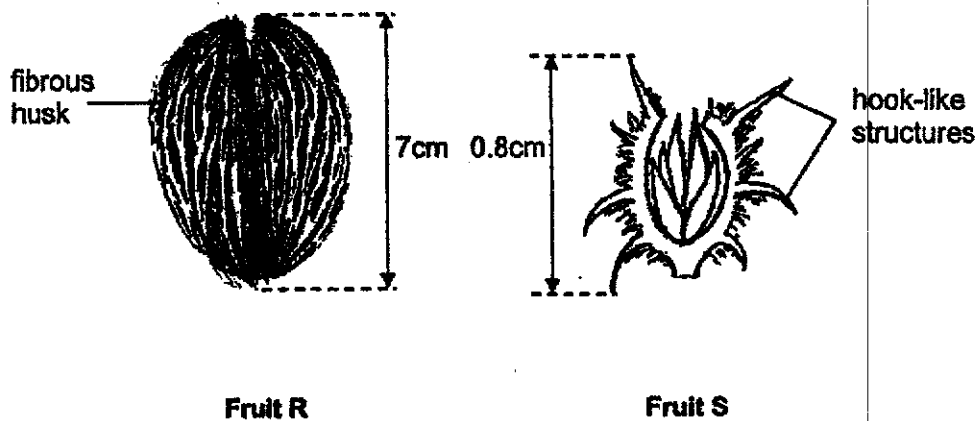

Based on the diagrams above, which of the following shows the most likely dispersal methods for fruits R and S?

	Fruit R	Fruit S
(1)	water	animals
(2)	water	wind
(3)	explosive action	animals
(4)	explosive action	wind

5. Which of the following statements are true for sexual reproduction in both plants and humans?

- A Pollination takes place before fertilisation.
 B Characteristics are passed on from parent to the young.
 C The male reproductive cell fuses with the female reproductive cell during fertilisation.

- (1) A and B only
 (2) A and C only
 (3) B and C only
 (4) A, B and C

6. Study the flowchart below carefully.

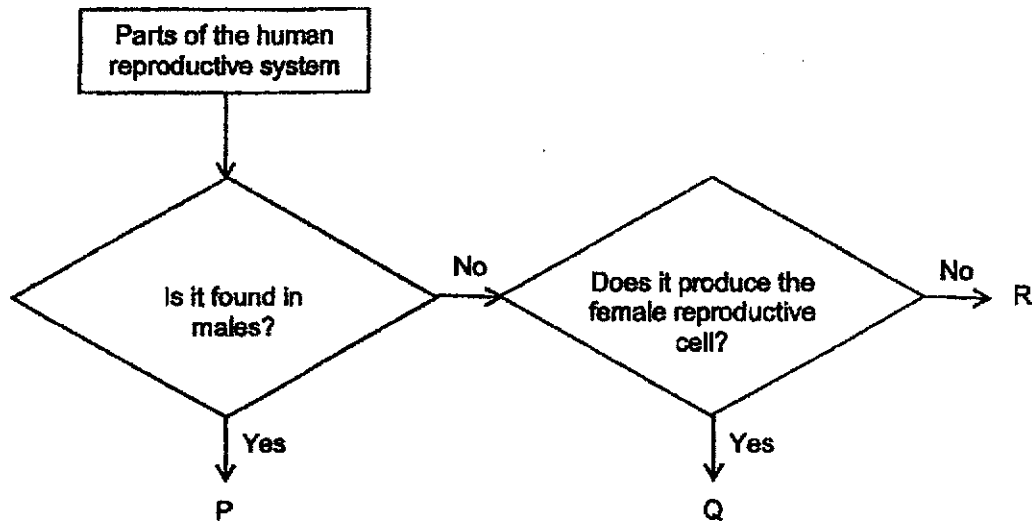

Which of the following correctly identifies parts P, Q and R?

	Part P	Part Q	Part R
(1)	vagina	ovary	penis
(2)	penis	ovule	womb
(3)	testis	ovary	womb
(4)	penis	ovule	vagina

7. Which of the following traits can be inherited?

- A Eye colour
- B Length of hair
- C Type of earlobe
- D Length of fingernails.

- (1) A and C only
- (2) B and D only
- (3) A, C and D only
- (4) A, B, C and D

8. Three cells X, Y and Z are shown below.

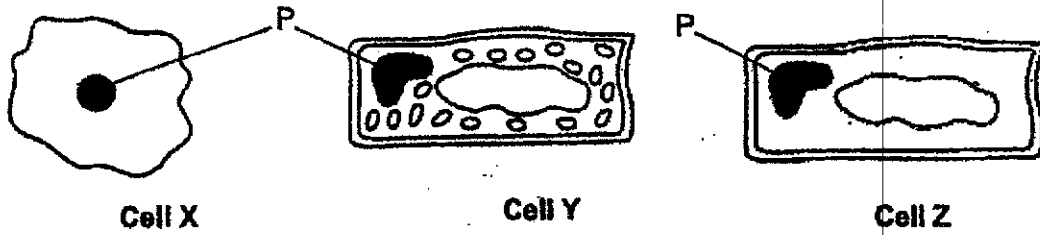

Which of the following gives the correct classification of the cells and function of part P?

	Plant Cell	Animal Cell	Function of part P
(1)	Y	X and Z	gives the cell a shape
(2)	Y	X and Z	contains genetic information
(3)	Y and Z	X	controls all the activities in a cell
(4)	Y and Z	X	gives the cell a shape

9. Ryan placed four identical fruits in four identical sealed boxes. He placed boxes A and B in the refrigerator and boxes C and D in a warm place. Substance K absorbs oxygen found in the box.

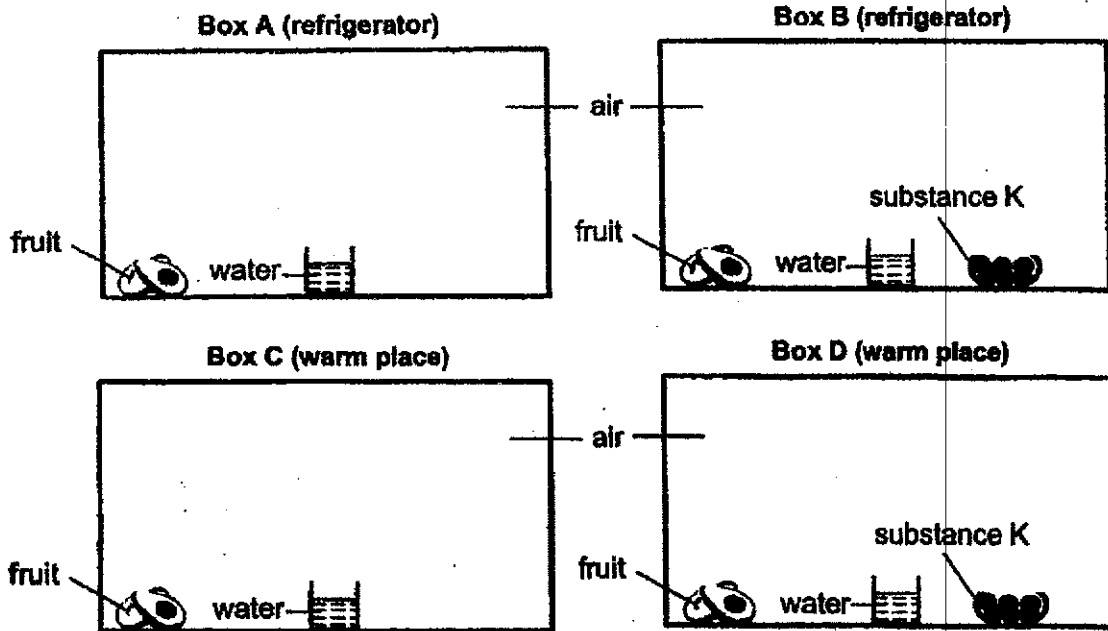

Based on the information above, in which box(es) would fungus appear on the fruit?

- (1) C only
- (2) A and C only
- (3) B and D only
- (4) A, B and D only

10. Fish use part X for gaseous exchange with the surroundings.

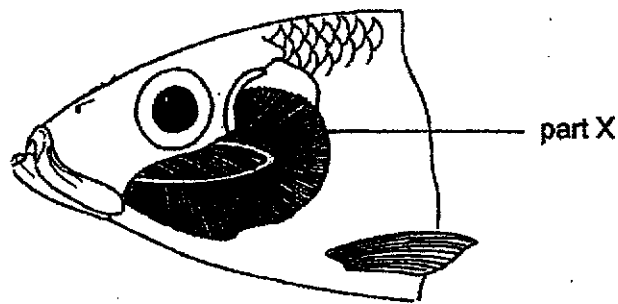

Which of the following statements about part X is correct?

- A Part X is rich in blood vessels.
 B Part X absorbs water rich in oxygen.
 C Water flows over part X for the exchange of gases.
- (1) A and B only
 (2) A and C only
 (3) B and C only
 (4) A, B and C

11. Ari removed the food-carrying tubes of a plant at position L as shown in the diagram below.

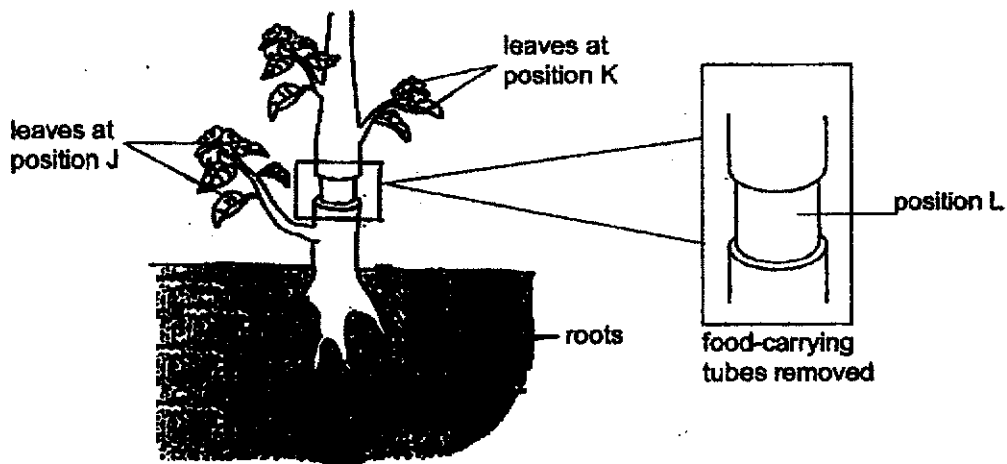

Ari then made the following predictions. Which of the following statements is correct?

- (1) The roots of the plant will die as they cannot receive food.
 (2) The plant will continue to survive as all parts can still receive food and water.
 (3) The leaves at position J will wither as they cannot receive water from the roots.
 (4) The leaves at position K will wither as they cannot receive water from the roots.

12. The food-carrying tubes of a stem were removed from a plant as shown below. The plant was left under the sun and watered every day.

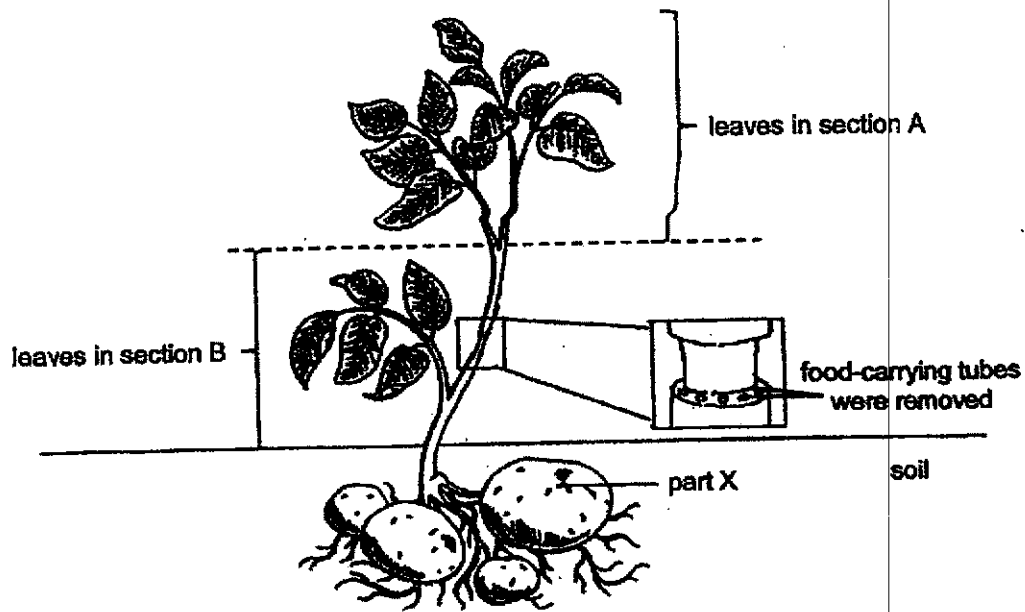

Part X was observed to be bigger after a month.

Which of the following best explains the observation?

- (1) Part X made its own food.
- (2) Food made in the leaves in section A was transported to and stored in part X.
- (3) Food made in the leaves in section B was transported to and stored in part X.
- (4) Food made in leaves in both sections A and B was transported to and stored in part X.

13. Study the diagram below. P, Q, R and S represent blood vessels.

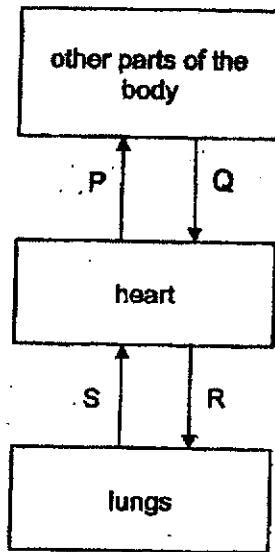

Direction of blood flow in a human

Based on the diagram above, which one of the following statements is not correct?

- (1) P, Q, R and S contain oxygen.
- (2) Q contains less oxygen than P.
- (3) R contains less carbon dioxide than S.
- (4) Q contains more carbon dioxide than S.

14. The table below shows the characteristics of two animals, A and B.

Characteristics	Animal	
	A	B
The adult has six legs.	Yes	No
The young looks like the adult.	No	No
The young and the adult are both plant-eaters.	Yes	No
The animal spends all its life stages on land only.	Yes	No

Which one of the following correctly shows what animals A and B might be?

	A	B
(1)	beetle	chicken
(2)	butterfly	frog
(3)	frog	butterfly
(4)	chicken	beetle

15. The graph below shows the number of days that insects L and M spend at each stage of their life cycle.

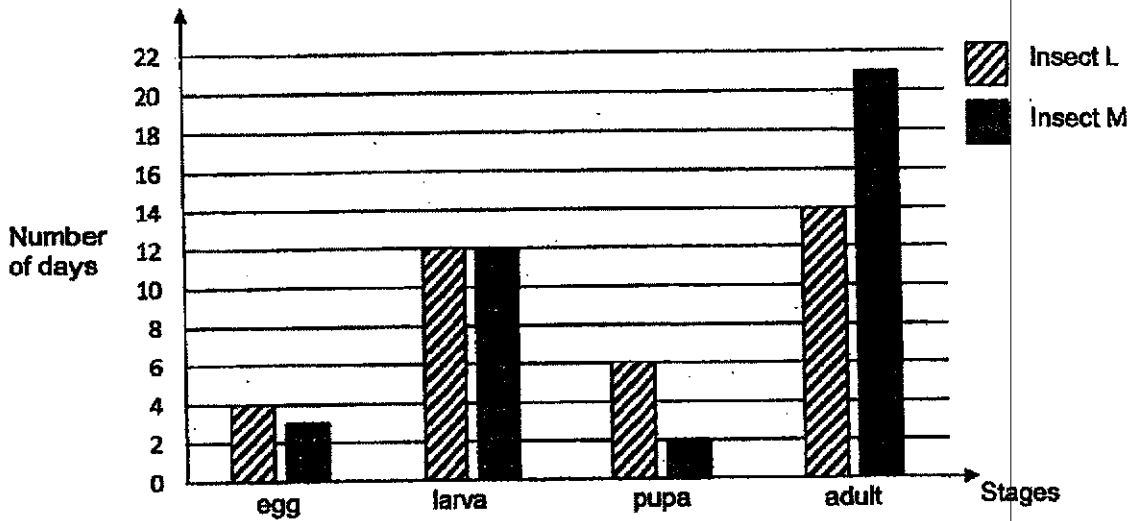

Based on the information in the graph, which of the following statement(s) is/are correct?

- A Insect L can be a beetle while insect M can be a grasshopper.
 B Insect M spends a longer time in the adult stage than insect L.
 C Both insects L and M take the same time for the young to develop into an adult after hatching from the egg.

- (1) A only
 (2) B only
 (3) C only
 (4) B and C only

16. Study the flowchart below.

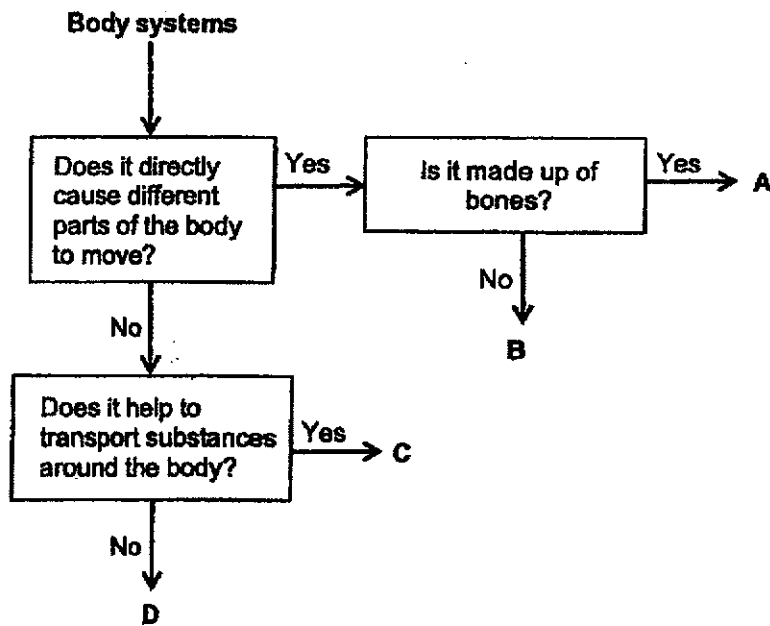

Based on the flowchart, which of the following correctly identifies human body systems A, B, C and D?

	A	B	C	D
(1)	Skeletal	Muscular	Digestive	Respiratory
(2)	Muscular	Respiratory	Circulatory	Digestive
(3)	Skeletal	Muscular	Circulatory	Digestive
(4)	Muscular	Circulatory	Digestive	Respiratory

17. Wendy wanted to conduct an experiment to test the following hypothesis:

An object with a greater mass possesses more potential energy when it is above the ground.

She set up four blocks using strings of different lengths as shown below.

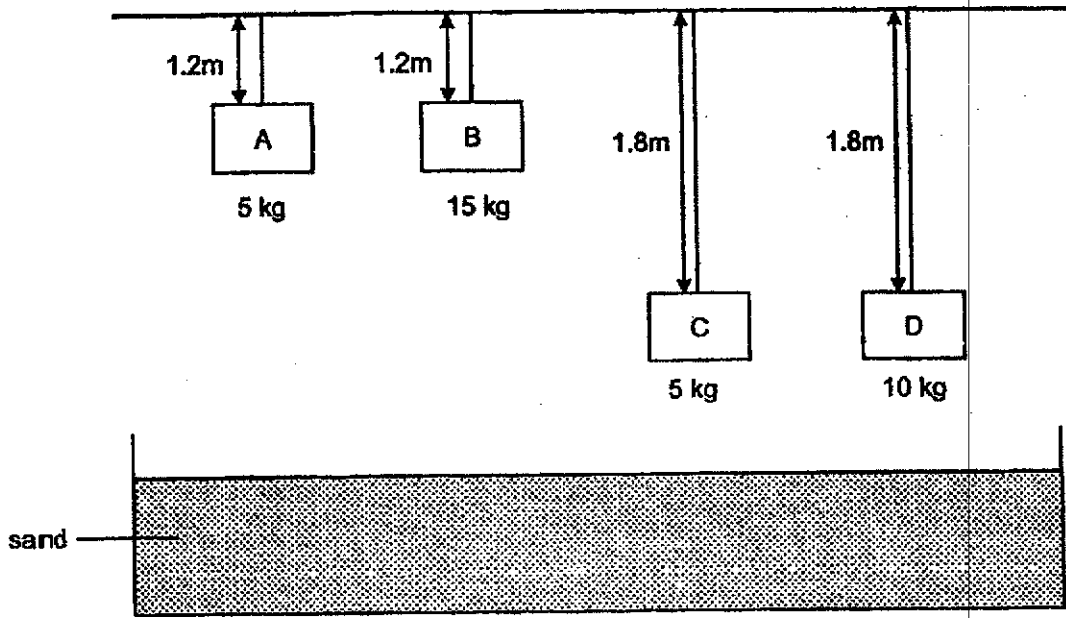

Which two blocks should she use to test her hypothesis?

- (1) Blocks A and C
- (2) Blocks A and D
- (3) Blocks B and C
- (4) Blocks C and D

18. The diagram below shows a cart on a track.

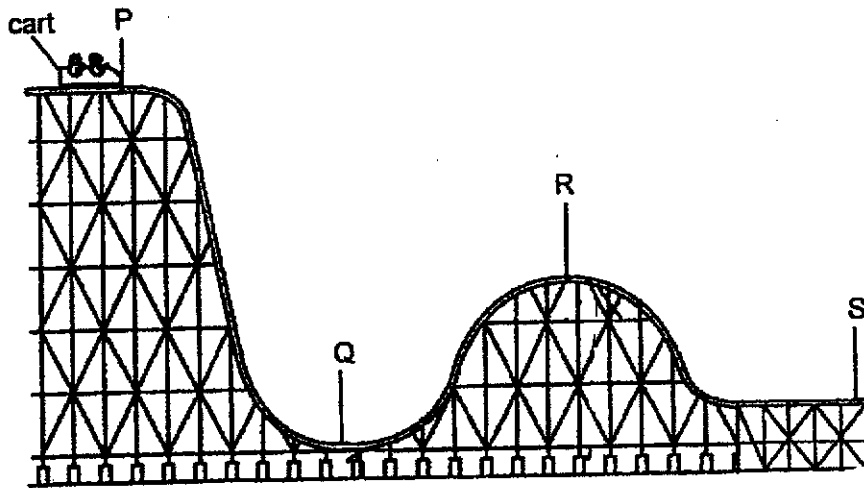

At which point would the cart have the greatest amount of potential energy?

- (1) Point P
 (2) Point Q
 (3) Point R
 (4) Point S
19. Sam used a trolley to push some boxes for delivery. He observed that the trolley moved more easily as each box was taken out.

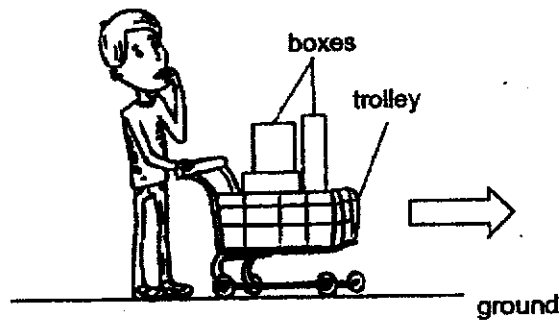

Which of the following statement(s) is/are correct?

- A There is less frictional force between the trolley and the ground when there are fewer boxes.
 B There is more gravitational force acting on the trolley and boxes as each box was taken out.
 C The amount of frictional force between the trolley and the ground is not affected by the number of boxes in the trolley.

- (1) A only
 (2) C only
 (3) A and B only
 (4) B and C only

20. The diagram below shows a beam balance with objects S and T hung at both ends. Both objects are of the same mass.

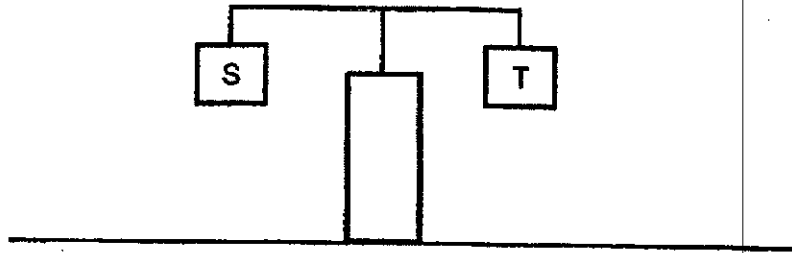

The diagram below shows what happens when an object, X, is placed below object T.

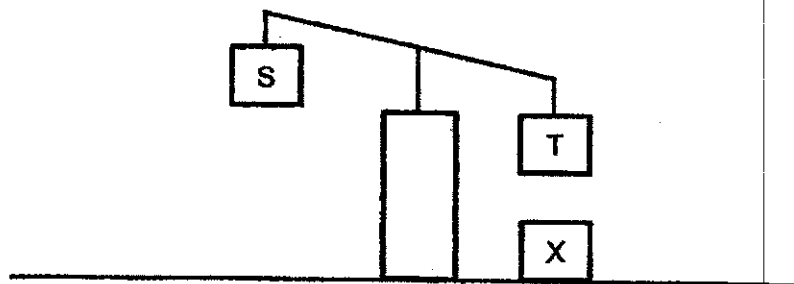

Based on the observations above, which one of the following best describes objects T and X?

	Object T	Object X
(1)	Magnet	Wooden block
(2)	Steel block	Magnet
(3)	Aluminium block	Magnet
(4)	Steel block	Plastic block

21. Sophie arranged four circuits, A, B, C and D, using batteries and bulbs that were working.

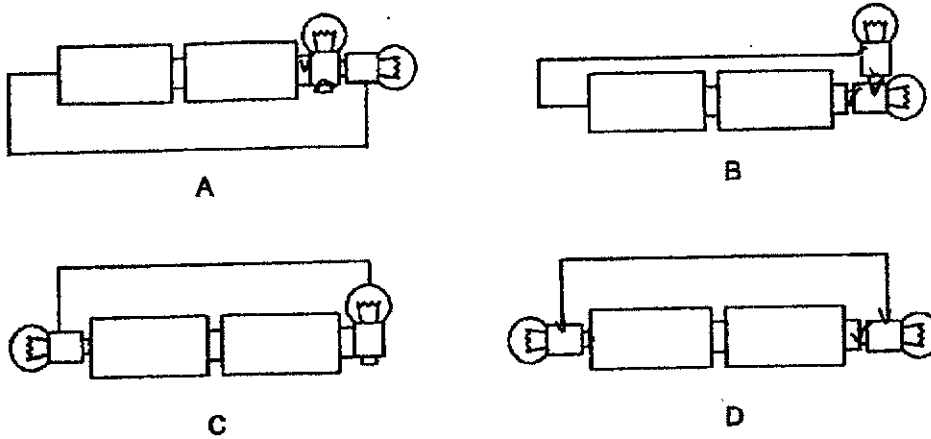

Which of the following will Sophie most likely observe?

- (1) For A and C, none of the bulbs will light up.
- (2) For B and D, both bulbs will light up in each circuit.
- (3) For A and D, only one bulb will light up in each circuit.
- (4) For B and C, only one bulb will light up in each circuit.

22. The diagram shows four working bulbs, B1, B2, B3 and B4 and four switches, S1, S2, S3 and S4 in a circuit.

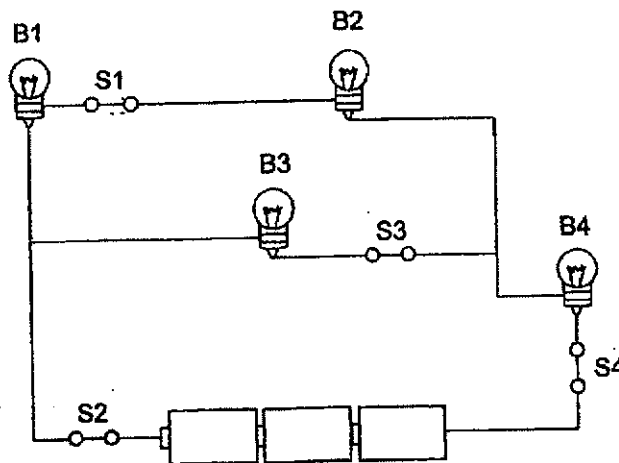

Which of the following shows the correct observation when the following switches are open?

	Open switch(es)	Observation
(1)	S1 and S2	Only B3 and B4 light up.
(2)	S1 and S3	Only B4 lights up.
(3)	S3	Only B1, B2 and B4 light up.
(4)	S4	Only B3 lights up.

23. Which of the following actions help to conserve electricity?

- A Use renewable sources of energy.
- B Choose energy-efficient appliances.
- C Turn on the air-conditioner instead of the fan.
- D Allow hair to dry naturally instead of using the hairdryer.

- (1) A and B only
- (2) A and C only
- (3) B and D only
- (4) B, C and D only

24. Tyler wanted to find out how much light can pass through three different materials, A, B and C. He placed material A between a light source and a light sensor and recorded the amount of light detected by the light sensor. He repeated the experiment using materials B and C. There was only one light source in the room.

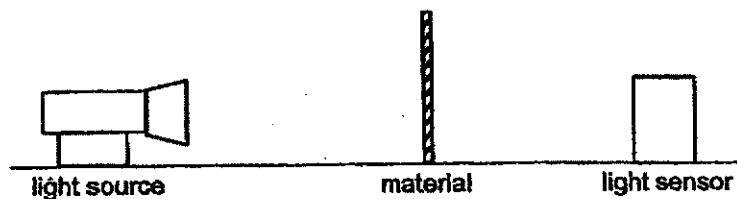

Materials	Amount of light detected by the sensor (units)
A	0
B	90
C	65
none	100

Based on the results, which of the following could represent materials A, B and C?

	A	B	C
(1)	tracing paper	clear plastic	cardboard
(2)	cardboard	tracing paper	clear plastic
(3)	cardboard	clear plastic	tracing paper
(4)	clear plastic	cardboard	tracing paper

25. Geetha sat for a test in the air-conditioned school hall for two hours. She had left 2 rulers on her table and they were unused throughout the test. She then picked up both rulers to keep in her pencil case and noticed that the metal ruler was colder than the wooden ruler.

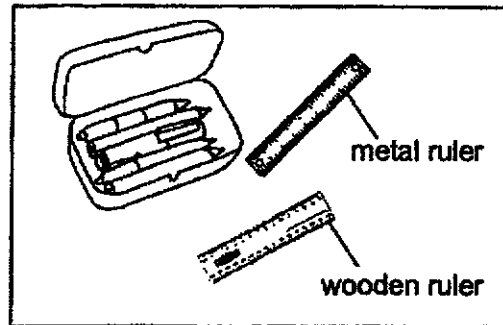

Which of the following is the correct explanation for her observation?

- (1) The wooden ruler lost more heat to the room.
 - (2) Geetha lost more heat to the metal ruler when she held it.
 - (3) Geetha gained more heat from the wooden ruler when she held it.
 - (4) The metal ruler was at a lower temperature than the wooden ruler.
26. The diagram below shows a 500 cm³ jar. It contains 200 cm³ of water. When the plunger was pushed all the way down, 150 cm³ of air in the pump went into the jar.

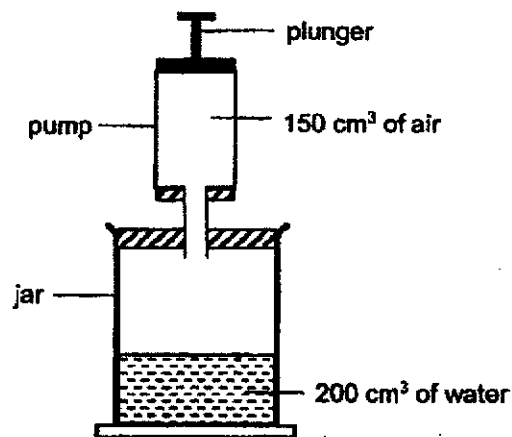

What was the volume of the air in the jar after the plunger was pushed down?

- (1) 150 cm³
- (2) 300 cm³
- (3) 350 cm³
- (4) 450 cm³

27. Tristan used the stroke method to magnetise four identical iron nails, W, X, Y and Z. He stroked the nails 15, 30, 45 and 60 times respectively.

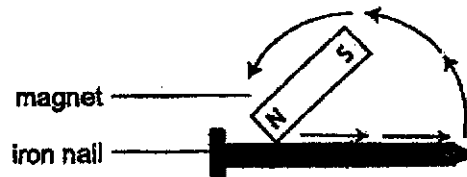

He then brought each iron nail close to a paper clip and measured the greatest distance from where the magnetised iron nail could start to attract the paper clip. He repeated his experiment three times.

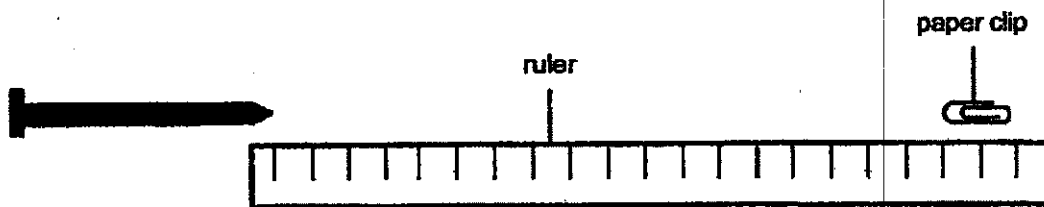

What was the aim of his experiment?

- (1) To find out how the number of times an iron nail is stroked affects its magnetic strength.
- (2) To find out how the number of times an iron nail is stroked affects the number of paper clips it attracts.
- (3) To find out how the distance at which the iron nail attracts a paper clip affects its magnetic strength.
- (4) To find out how the distance at which the iron nail attracts a paper clip affects the number of paper clips it attracts.

28. A magnet and a steel bar were fixed to a wall as shown below.

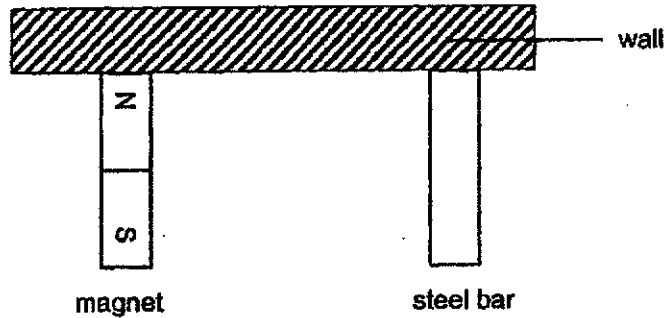

Two rods, X and Y, were brought close to the magnet and steel bar. The table below shows the observations made.

	Magnet	Steel bar
Rod X	attraction	no effect
Rod Y	repulsion	attraction

Which of the following correctly identifies rods X and Y?

	Rod X	Rod Y
(1)	iron rod	iron rod
(2)	magnet	iron rod
(3)	iron rod	magnet
(4)	magnet	magnet

~ END OF BOOKLET A ~



NANYANG PRIMARY SCHOOL

PRIMARY 6 SCIENCE

PRELIMINARY EXAMINATION
2021

BOOKLET B

Duration for Booklets A and B: 1 h 45 min

Name: _____ ()

Class: Primary 6 ()

Marks Scored:

Booklet A:		56
Booklet B:		44
Total :		100

Any query on marks awarded should be raised by the next day. We seek your understanding in this matter as any delay in the confirmation of marks will lead to delays in the generation of results.

Parent's signature:

**DO NOT OPEN THIS BOOKLET UNTIL YOU ARE TOLD TO DO SO.
FOLLOW ALL INSTRUCTIONS CAREFULLY.**

Booklet B consists of 17 printed pages including this cover page.

Blank Page

Section B: Open-Ended Questions [44 marks]

Write your answers to questions 29 to 40 in the spaces provided.

29. Minah, Nadia and Owen compared the life cycle of a cockroach with that of a mosquito and made the following statements.

Minah: Both animals have a three-stage life cycle.

Nadia: Both animals have wings in the adult stage.

Owen: The young of both animals resemble the adult.

- (a) Which two children made the wrong statements? Give a reason why their statements are wrong. [2]

(i) Name of student: _____

Reason: _____

(ii) Name of student: _____

Reason: _____

The adult mosquito can spread diseases to humans. However, it is difficult to get rid of the adult mosquito.

- (b) Based on the life cycle of the mosquito, explain how each of these actions carried out regularly would help to reduce the number of mosquitoes before they reach the adult stage. [2]

(i) Action 1: remove stagnant water that collects in the environment

(ii) Action 2. spray oil on water in drains



30. The diagram below shows fruit S.

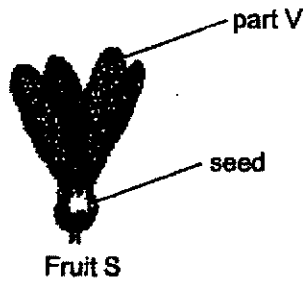

Suresh carried out an experiment with the fruit. He used one fruit S with 4 of part V and dropped the fruit from the same height above the ground. He recorded the distance, d , travelled by fruit S from the starting point to the point where the fruit landed on the ground, as shown in the diagram below.

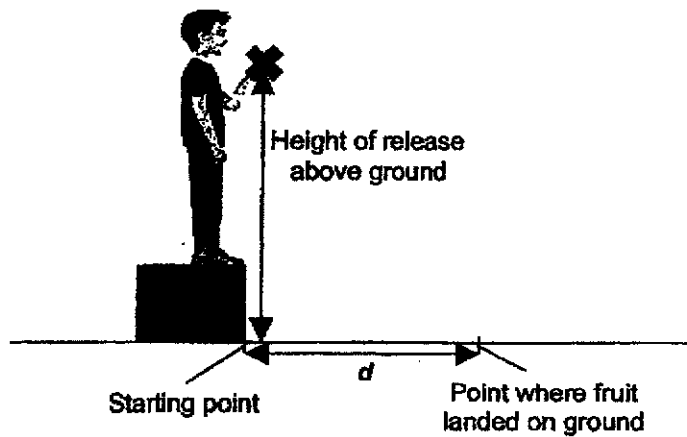

He then removed part V one at a time and repeated the experiment. The table below shows his results.

Number of part V on Fruit S	Distance, d (cm)
4	250
3	125
2	50
1	20

(a) What was the aim of Suresh's experiment?

[1]

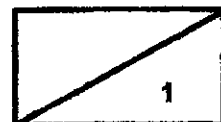

(Continue from Question 30)

(b) Based on the results recorded in the table, what is the relationship between the number of part V on Fruit S and the distance travelled by Fruit S? [1]

(c) Give a reason why his results were not reliable. [1]

(d) State two characteristics of fruits dispersed by wind. [1]

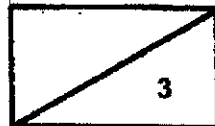

31. The diagram below shows the human respiratory system.

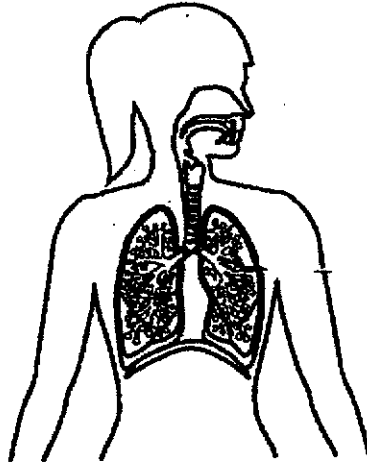

(a) In the diagram above, identify and label the part of the human respiratory system that allows gaseous exchange to take place with the blood. [1]

Wei Qi and his brother were trapped in a faulty lift for 30 minutes. Fresh air could not enter or leave the lift.

(b) (i) Describe the changes in the amount of oxygen and carbon dioxide in the lift after 30 minutes. [1]

Oxygen: _____

Carbon dioxide: _____

(ii) Explain your answer in (b)(i). [1]

32. The respiratory system works with body system X to transport oxygen to all parts of the body.

(a) Identify body system X. [1]

(b) Describe how parts of both body systems work together to remove carbon dioxide from the body to the surrounding air. [1]

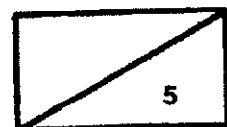

33. Adil mixed a red substance with water to form a red-coloured liquid. He then conducted an experiment to find out how presence of roots affects the amount of red-coloured liquid left as shown below.

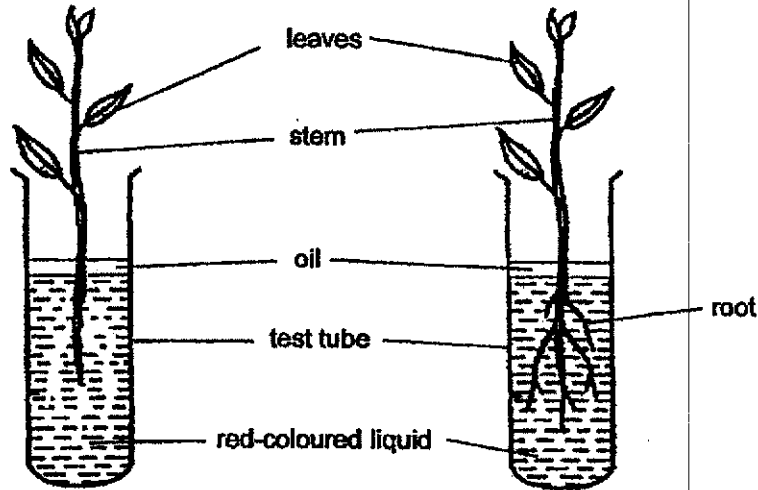

(a) What is the function of the roots that is being investigated in Adil's experiment? [1]

(b) After some time, Adil noticed that the leaves of the plants turned red. Explain his observation using the specific plant parts involved. [1]

Adil has two rulers that he could use to measure the height of the water level in the test tubes as shown below.

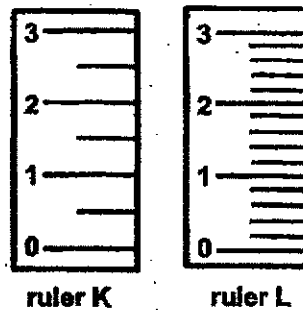

(c) Explain why ruler L is a better choice to measure the height of the water level. [1]



34. The diagram below shows the human digestive system.

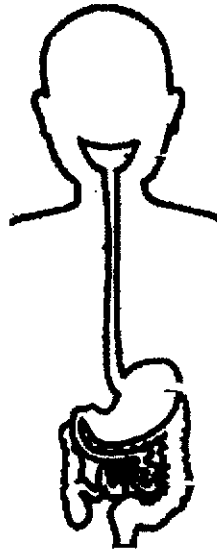

(a) (i) In the diagram above, identify and label the parts where digestion takes place. [1]

(ii) What is the function of digestive juices? [1]

Some elderly are missing a lot of teeth. They have difficulty eating big pieces of food.



(b) Explain how having fewer teeth could result in a lower rate of digestion. [2]

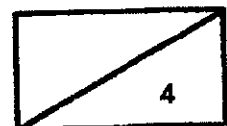

35. Xiaoli played badminton using a racket with a plastic handle. While playing, she perspired a lot and her racket kept slipping from her hand.

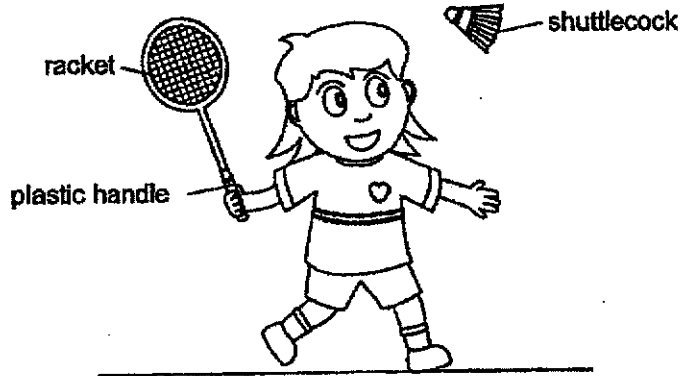

Before the next game, she taped the plastic handle with material A. Material A was not waterproof. She found that the racket did not slip from her hand during the game.

(a) Based on the information given, explain, in terms of forces, how this property of material 'A' helped Xiaoli to grip her racket better. [2]

During the game, Xiaoli hit the shuttlecock in the direction of her brother who was facing her. He then hit it back in her direction so fast that she could not hit the shuttlecock back.

(b) State the 2 effects on the shuttlecock when Xiaoli's brother hit it. [1]

(i) Effect 1: _____

(ii) Effect 2: _____

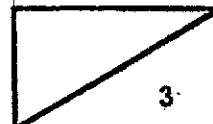

36. Wen Jie built a toy as shown in diagram 1 below. He pushed the handle down and compressed the spring to point A as shown in diagram 2. When the handle was released, ball X was launched upwards. It reached height B and fell back down to the handle again.

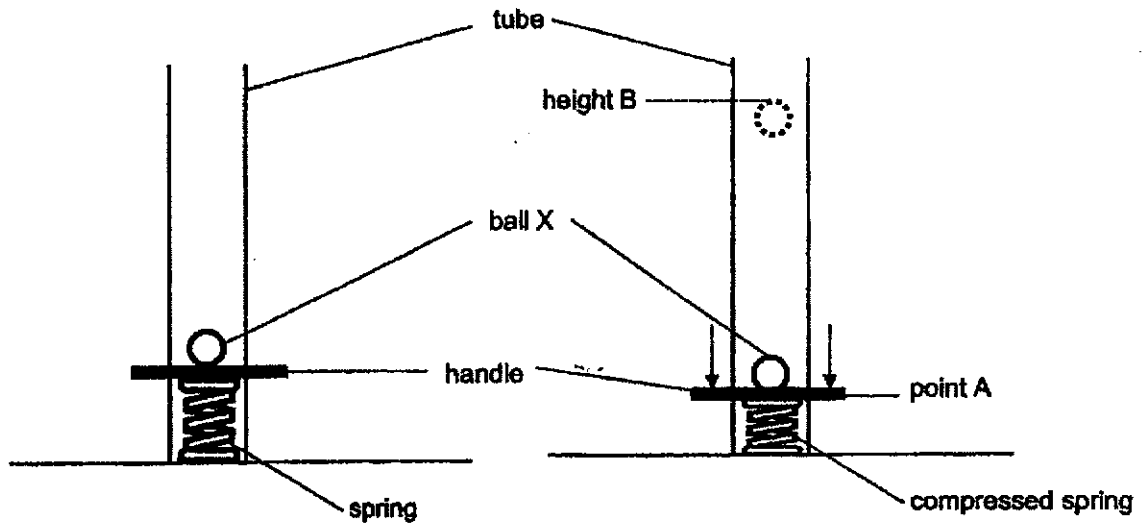
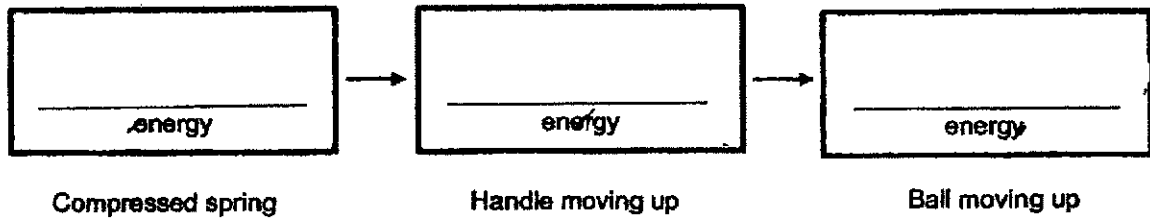

Diagram 1

Diagram 2

(a) State the main energy conversion that was taking place in the toy. [1]



Wen Jie noticed that after the ball touched the handle, it bounced back up but did not reach height B.

(b) Explain his observation in terms of energy conversion. [2]

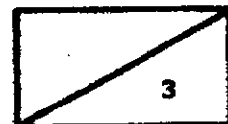

(Continue from Question 36)

Wen Jie wanted to launch ball X to a greater height, C, as shown in the diagram below.

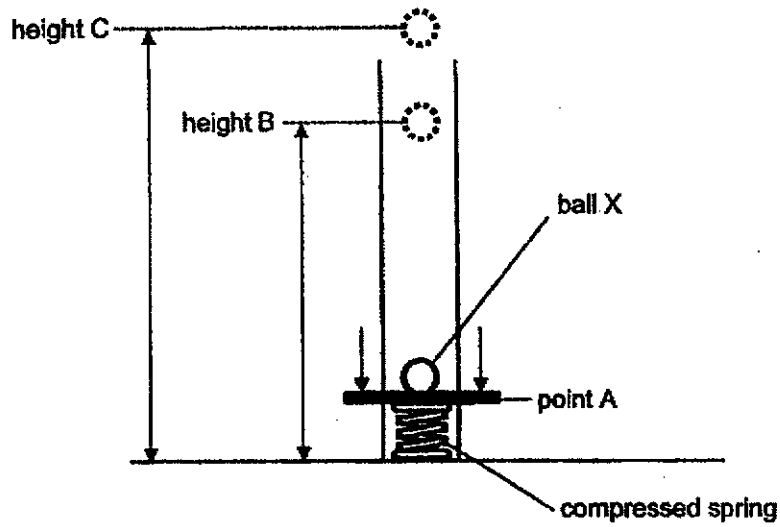

- (c) Using the same apparatus, what should Wen Jie do to launch ball X to height C instead of height B? [1]

Wen Jie replaced ball X with ball Y, which was of the same size. He then compressed the spring to point A again before launching the ball. The ball reached a maximum height that was lower than height B.

- (d) Suggest one difference between balls X and Y that could have caused this observation. [1]

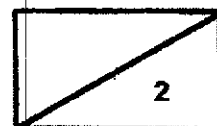

37. Jeremy was given two objects made of different materials, P and Q, to find out if they conduct electricity. He connected both objects in a circuit as shown below to test them. All the bulbs and batteries were in working condition.

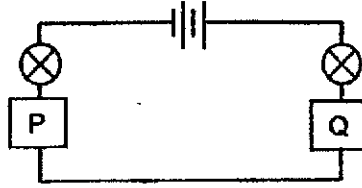

Jeremy's circuit

He observed that the bulbs did not light up and concluded that both objects P and Q did not conduct electricity.

- (a) Based on the circuit diagram above, explain why his conclusion may not be correct. [2]

Jeremy changed the arrangement of the electrical components in his circuit to confirm if objects P and Q could conduct electricity.

- (b) Using all the same electrical components, draw a circuit diagram that Jeremy could use to make a definite conclusion. [1]

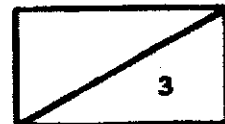

38. Mrs Tan placed four identical eggs in beakers with different amounts of water and at different temperatures. Set-ups P, Q, R and S were left for five minutes. The eggs gained heat from the water and were cooked to different extents.

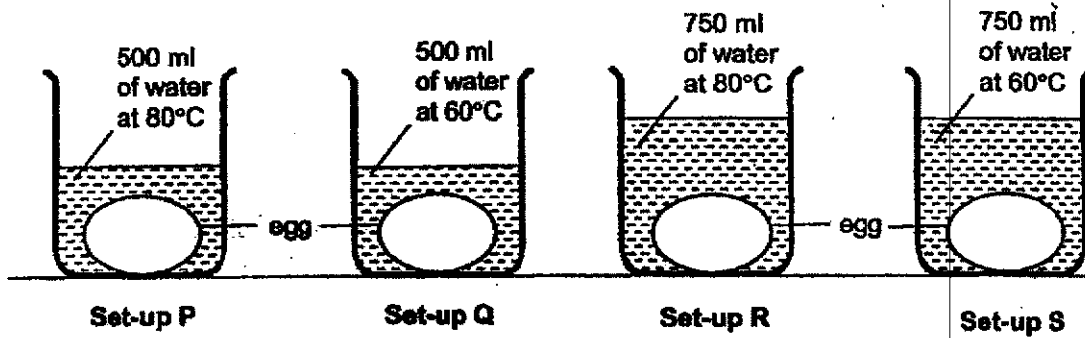

(a) After five minutes, in which set-up, P, Q, R or S, will the egg be the most cooked? Explain your answer. [2]

(b) Without changing the volume and temperature of water in set-up P, suggest another way Mrs Tan can ensure the egg in it cooks more fully. [1]

Mrs Tan then prepared another two set-ups, T and U, as shown below.

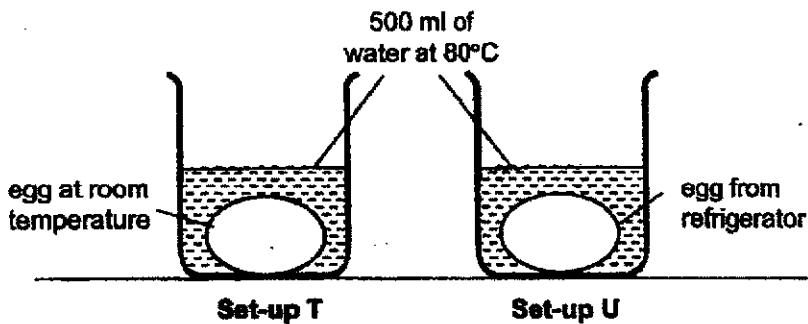

(c) Would the egg in set-up U be less cooked or more cooked after five minutes as compared to set-up T? Explain your answer. [1]

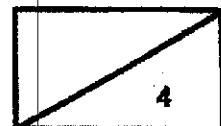

39. Vanessa carried out an experiment using a torch, a wooden ball and a screen as shown in the diagram below. She wanted to find out how the distance of the torch from the wall affects the height of the shadow formed. She carried out the following steps.
(The diagram is not drawn to scale.)

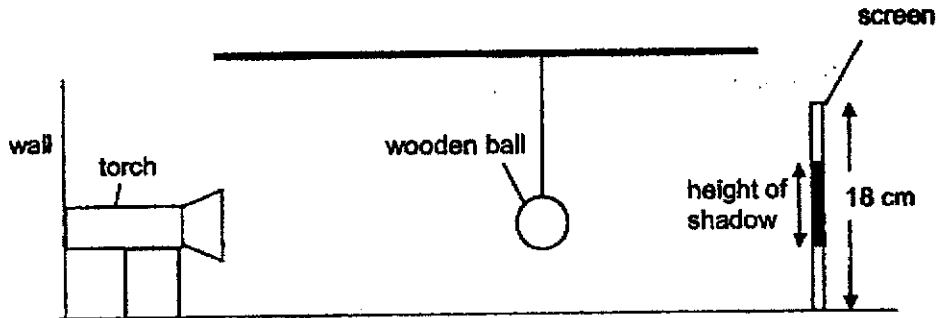

- Step 1: Switch on the torch.
 Step 2: Measure and record the height of the shadow formed on the screen.
 Step 3: Move the torch 5 cm away from the wall.
 Step 4: Measure and record the height of the shadow formed on the screen.
 Step 5: Repeat steps 3 and 4 two more times.

- (a) State a hypothesis on how the distance of the torch from the wall affects the height of the shadow formed. [1]

The table below shows her results.

Distance of torch from wall (cm)	Height of shadow (cm)
5	4
10	12
15	18
20	18

- (b) Based on the information above, how did the distance between the torch and the wall affect the height of the shadow formed on the screen? [2]

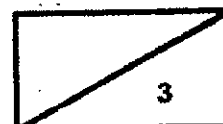

(Continue from Question 39)

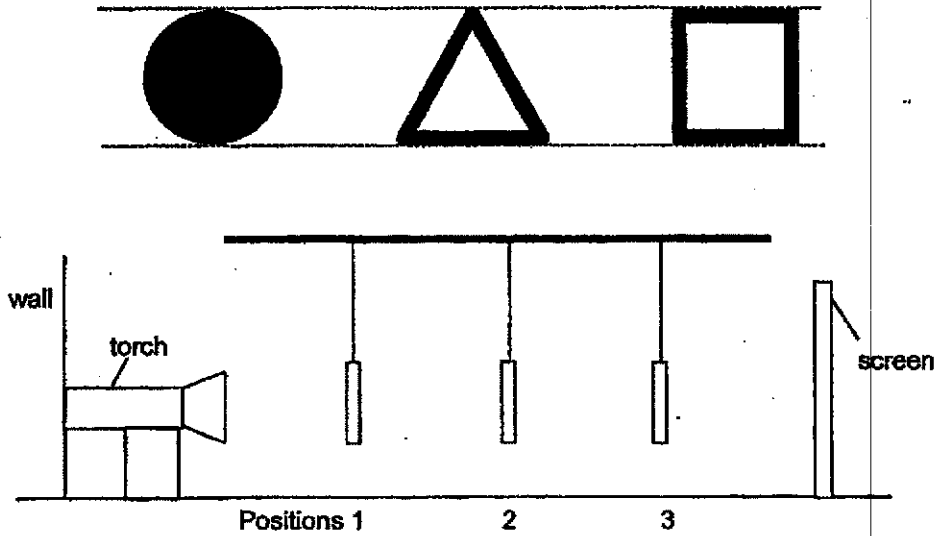

Next, she hung three cardboard shapes of the same height and width at positions 1, 2 and 3 as shown in the diagram below. Only two of them have a hole cut out in the middle.

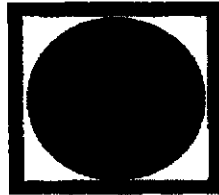

The diagram below shows the shadow that she observed on the screen.

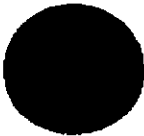

(C) Based on the shadow formed, state the positions of the shapes in the set-up above. [1]

Shape	Position in the set-up
	
	
	

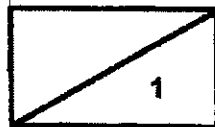

40. (a) State what melting means. [1]

Ali conducted an experiment using 2 identical blocks of ice. He placed each block of ice in a beaker and placed them in similar rooms of different temperatures as shown below.

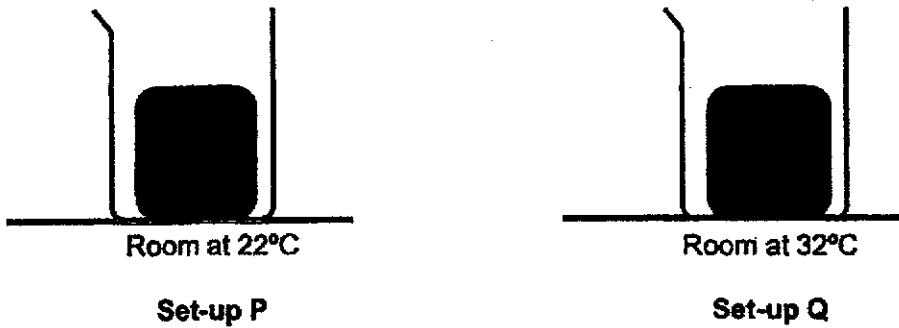

He then removed the ice blocks after 15 minutes and measured the amount of liquid collected in the beaker. He recorded his results in the table below.

Set-up	Amount of liquid in the measuring cylinder (ml)
P	35
Q	70

- (b) Explain why there was less liquid collected in set-up P compared to set-up Q [2]

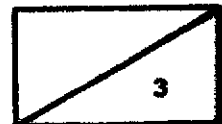

(Continue from Question 40)

Two identical glasses, X and Y, with water at 20°C were placed in similar rooms of different temperatures as shown below.

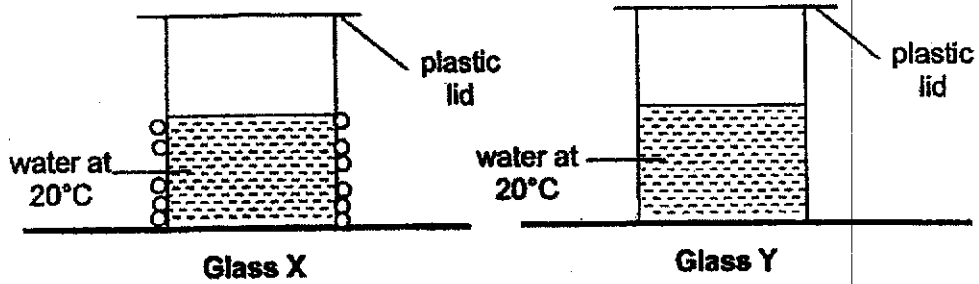

After a while, tiny water droplets were observed outside glass X but not outside glass Y. Both glasses had been left untouched.

(c) Explain why no water droplets were formed outside glass Y. [2]

~ END OF BOOKLET B ~

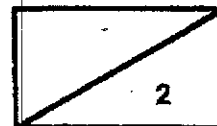

**Prelim 2021
Suggested Answers
Section A**

1	4	11	2	21	2
2	3	12	3	22	3
3	4	13	3	23	3
4	1	14	2	24	3
5	3	15	2	25	2
6	3	16	3	26	2
7	1	17	4	27	1
8	3	18	1	28	3
9	1	19	1		
10	2	20	2		

Section B

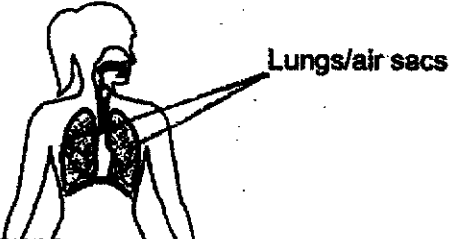
Qn No	Acceptable Answers
29.(a)	Minah. The mosquito has a four-stage life cycle but the cockroach has a three-stage life cycle. Owen. The young of the mosquito does not resemble the adult but the young of the cockroach resembles the adult.
(b)(i)	Action 1 There will be no place to lay eggs. (Effect of action) So there will be fewer eggs to hatch and develop into larva and adults. (Effect on life cycle)
(ii)	Action 2 The young of the mosquito will not be able to obtain air/ cannot breathe (0.5m) and will die (0.5m).
30. (a)	To find out <u>how</u> the number of part V affects the distance fruit S travels.
(b)	As the number of part V on the fruit decreases, the distance travelled by the fruit decreases.
(c)	He did not repeat the experiment at least 3 times.
(d)	The seed should be light, small and has wing-like structure (any 2 characteristics)
31. (a)	
(b)(i)	Oxygen: decreased Carbon dioxide: increased
(ii)	Wei Qi and his brother took in oxygen and gave out carbon dioxide.
32. (a)	Circulatory system
(b)	The <u>blood</u> in body system X transports carbon dioxide away from all parts of the body and brings it to the <u>lungs</u> to be exhaled through the <u>nose</u> .
33. (a)	To absorb water and mineral salts.

(b)	The <u>water-carrying tubes</u> transported the liquid to the leaves.
(c)	Ruler L has more scale markings and therefore will give more accurate measurements of the height of water level.
34.	
(a)(i)	Label mouth, stomach, small intestine
(ii)	Digestive juices break down food into simpler substances.
(b)	<u>Food is in bigger pieces</u> so there will be <u>less exposed surface area of food to digestive juices</u> .
35.(a)	Material A absorbed Xiaoli's perspiration so there was increased friction between Material A and her hand.
(b)	<ul style="list-style-type: none"> • The shuttlecock changed direction. • The shuttlecock changed speed.
36. (a)	potential energy \rightarrow kinetic energy \rightarrow kinetic energy/ potential energy
(b)	Some kinetic energy of the ball was converted to heat energy and sound energy. The ball had less kinetic energy to reach B.
(c)	Push the handle down more.
(d)	Ball Y had a greater mass than ball X.
37. (a)	Either object P or Q could be a conductor of electricity. However, since both objects are arranged in series with the bulbs, they will not light up as it is an open circuit.
(b)	
38. (a)	Set-up R. It had the <u>most water</u> at the <u>highest temperature</u> so the water possessed the <u>most heat</u> .
(b)	Allow the egg to cook for longer than 5 minutes.
(c)	Less cooked. The egg from the refrigerator was at a <u>lower temperature</u> so it needed to <u>gain more heat</u> to be cooked.
39. (a)	<i>(All hypothesis accepted as long as it addresses the question)</i> The <u>greater the distance of the torch from the wall, the greater the height of the shadow formed.</u>
(b)	As the distance between the torch and the wall <u>increased</u> , the height of the shadow formed <u>increased until 15cm</u> . Above 15cm, the height of the shadow formed on the screen <u>remained the same</u> .
(c)	2, 3, 1
40. (a)	When a solid gains heat and changes to a liquid at a fixed temperature.
(b)	The room for set-up P had a <u>lower temperature</u> than for set-up Q. The ice block in set-up P <u>gained less heat from the surroundings</u> than in set-up Q. Hence, the block of ice melted <u>slower</u> .
(c)	There was <u>no temperature difference</u> between the the glass of water in set up Y and the surrounding air. Hence, the <u>water vapour in the air could not lose heat and condense</u> .