

SAT

TAO NAN SCHOOL
Primary 6 Science Mid-year Examination – 2005

Name: _____ ()

Date: 12 May 2005

Class: Primary 6 ()

Duration: 1h 45min

Parent's signature: _____

Marks: _____/100

Section A (30 x 2 marks)

For each question 1 to 30, four options are given. One of the four options is the correct answer. Select the correct answer and shade its corresponding oval (1, 2, 3, 4) on the Optical Answer Sheet.

1. Which part of the digestive system absorbs water only?

- (1) gullet
- (2) stomach
- (3) small intestine
- (4) large intestine

2. Which of the following is/are function(s) of a skeleton?

- (A) It supports the body.
- (B) It gives the body shape.
- (C) It provides spaces for the organs inside the body.
- (D) It protects important organs inside the body from injury.
- (E) It allows muscles to attach themselves to enable the body to move.

- (1) C and D only
- (2) A, B and C only
- (3) C, D and E only
- (4) A,B,D and E only

71

3. Which of the following happen when our arms are straightened?



	Biceps	Triceps
(1)	contract	relax
(2)	relax	contract
(3)	contract	contract
(4)	relax	relax

4.

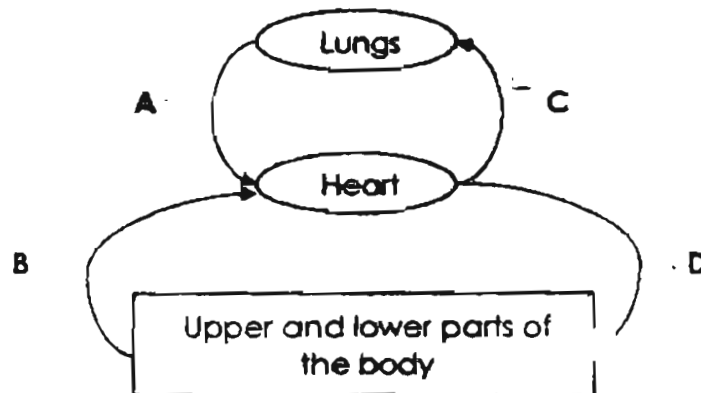

Blood flow in the body

	A	B	C	D
(1)	rich in O ₂	rich in CO ₂	rich in O ₂	rich in CO ₂
(2)	rich in O ₂	rich in O ₂	rich in CO ₂	rich in CO ₂
(3)	rich in O ₂	rich in CO ₂	rich in CO ₂	rich in O ₂
(4)	rich in CO ₂	rich in O ₂	rich in CO ₂	rich in O ₂

5. A ray of light falls on a mirror. Which of the following diagrams shows the correct path taken by the reflected ray?



6. Four beakers A, B, C and D were filled with different substances. The beakers were then left at room temperature.

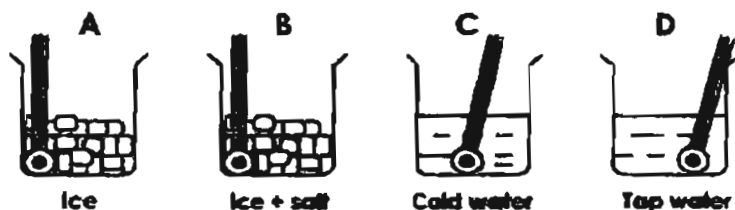

Which of the following shows the temperature of the four substances ranging from the highest to the lowest?

- (1) A, B, C, D
- (2) B, A, C, D
- (3) D, C, B, A
- (4) D, C, A, B

7. The diagram below shows a green leaf.

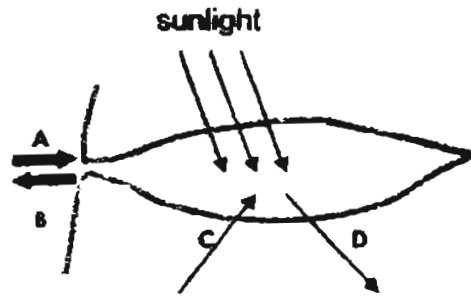

What do the arrows A, B, C and D in the diagram represent?

	A	B	C	D
(1)	glucose	water	oxygen	carbon dioxide
(2)	water	glucose	carbon dioxide	oxygen
(3)	glucose	water	carbon dioxide	oxygen
(4)	water	glucose	oxygen	carbon dioxide

8. The equation below shows how plants respire.



Which of the following best describe what happens during respiration?

- (A) It takes place in the cell.
- (B) It takes place in the dark.
- (C) Glucose and oxygen are the products of respiration
- (D) Carbon dioxide and water are the waste products.

- (1) A and B only
- (2) A and D only
- (3) B and C only
- (4) C and D only

- ✓9. Box Y contains an unknown object. X and Z are wires which are connected to the object in the box.

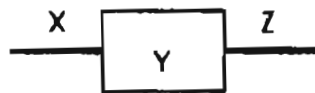

Miranda joins wire X to A and wire Z to B and the bulb lights up.

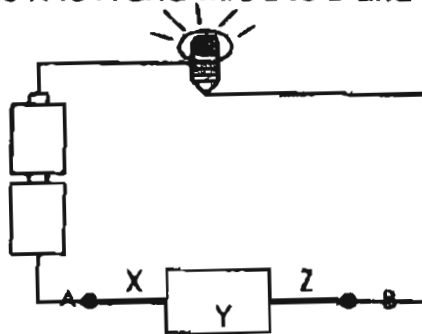

However, when she joins wire Z to A and wire X to B, the bulb did not light up.

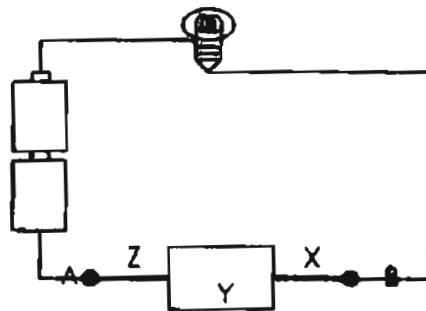

Which of the following objects could be in the box?



Aluminium foil
(1)



Pencil lead
(2)

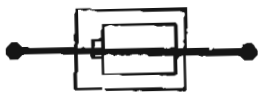

battery
(3)



wire
(4)

10. Which of the following are correctly classified according to their outer body covering?

(1)	scales	feathers	shell	hair
(2)	frog	platypus	turtle	porcupine
(3)	snail	whale	alligator	shark
(4)	dolphin	bat	terrapin	sea lion
(5)	tortoise	penguin	crab	pangolin

11. Study the classification chart below carefully.

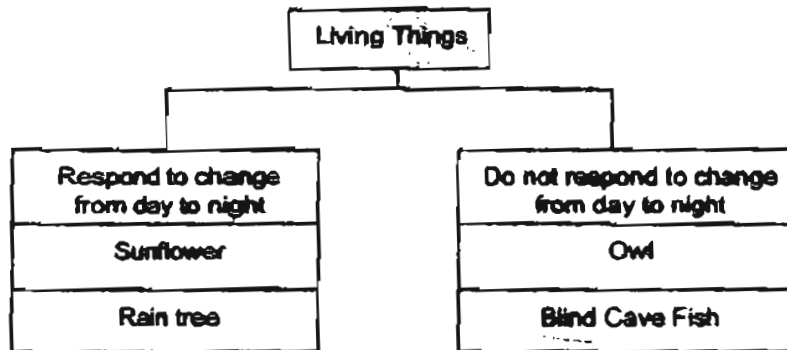

Which living thing above has been grouped wrongly?

- (1) Sunflower
- (2) Rain tree
- (3) Owl
- (4) Blind Cave Fish

✓12. Animals can be classified based on the segments on the body as shown below.

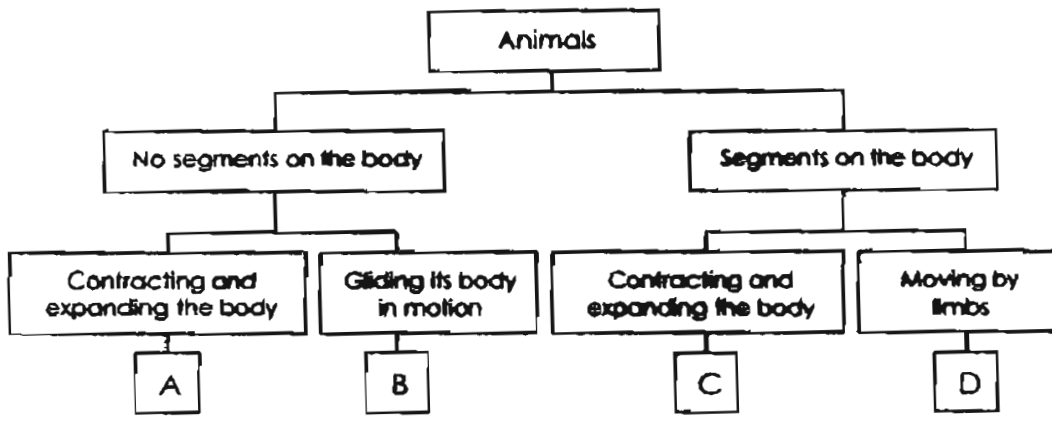

Where should 'python' and 'earthworm' be placed?

	python	earthworm
(1)	A	B
(2)	A	D
(3)	B	C
(4)	C	D

✓13. The table below shows how some objects have been classified based on certain property of their materials.

Group X	Group Y
Clear food wrap Tracing Paper Frosted glass crystal	Iron nails Steel plate Copper wire Porcelain cup

Which of the following are suitable headings for the two groups?

	Group X	Group Y
(1)	Man-made materials	Natural materials
(2)	Non-metals	Metals
(3)	Non-magnetic materials	Magnetic materials
(4)	Allow light to pass through	Do not allow light to pass through

14.

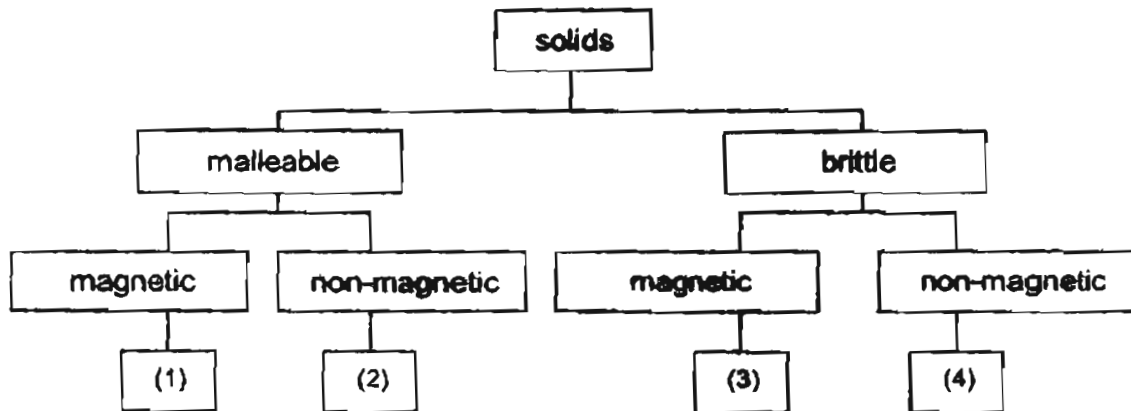

Where should 'copper' be placed?

15. The diagram below shows a dichotomous key for plants.

- A Does it have roots? Yes – go to B
No – then it is an algae.
- B Does it have seeds? Yes – go to C
No – go to D
- C Does it have flowers? Yes, then it is a mango tree.
No, then it is a pine tree.
- D Is it a land plant? Yes, then it is a stag horn fern.
No, then it is a water moss fern.

Which of the following charts correctly shows how plants are identified?

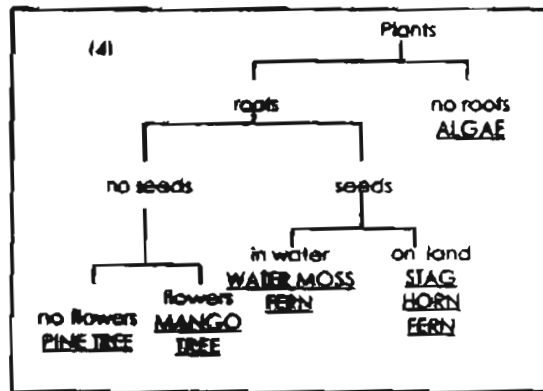
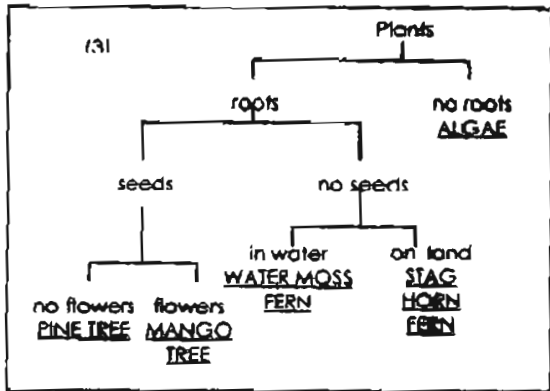
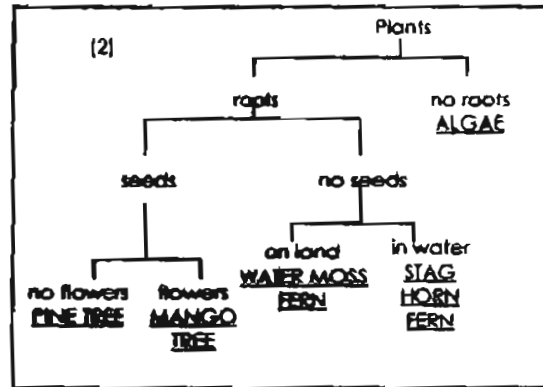
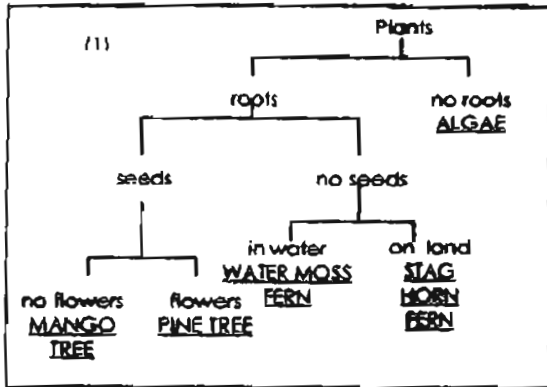

16. What forms of energy do three rotating gears have?

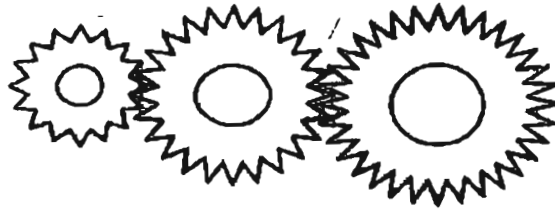

- A: Heat energy
- B: Electrical energy
- C: Sound energy
- D: Kinetic energy

- (1) A only
- (2) B only
- (3) C and D only
- (4) A, C and D only

17. Desiree touched a ping pong ball that was suspended from a retort stand with a struck tuning fork. The ball began to swing. The energy changes were recorded.

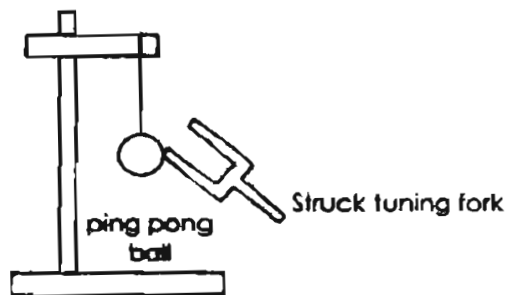

Which of the following shows the correct energy changes that she observed?

- (1) Chemical energy → Sound energy → Kinetic energy
- (2) Potential energy → Kinetic energy → Chemical energy
- (3) Kinetic energy → Sound energy → Kinetic energy
- (4) Kinetic energy → Potential energy → Kinetic energy

18. Study the flowchart below carefully.

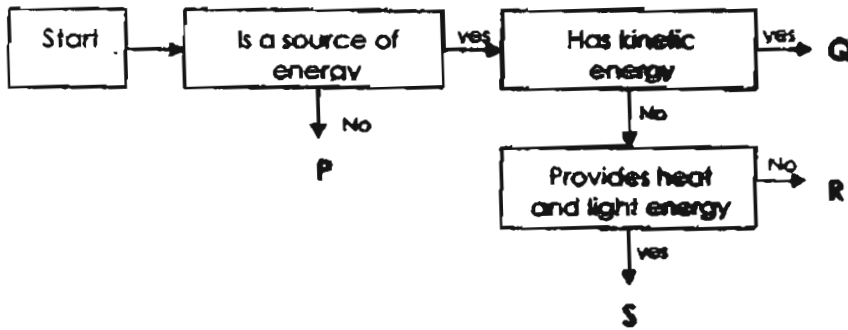

What could represent 'running water' and 'the Sun'?

	Running water	The Sun
(1)	P	Q
(2)	Q	R
(3)	Q	S
(4)	R	S

19. Four holes of the same size, A, B, C and D were made at different levels on a tall can. Each hole was fitted with a cork. The can was filled with water to the brim as shown below. All the corks were removed at the same time and water shot out from the holes.

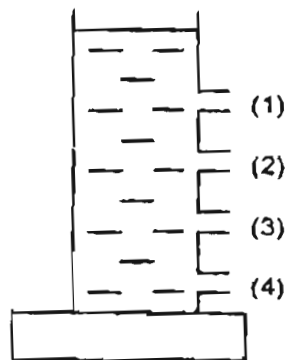

From which hole would the water shoot out the furthest from the can?

- ✓ 20. The diagram below shows a ball rolling down a track from P to Q.

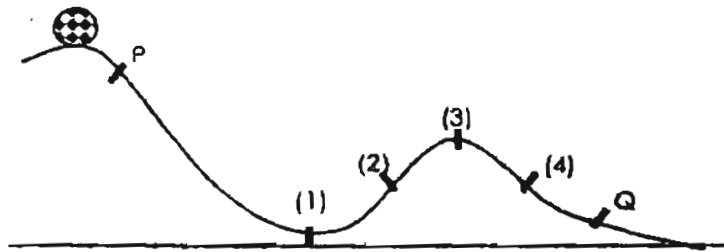

At which point between P and Q, does the ball possess the least amount of kinetic energy?

21. A basketball was dropped from a height of 400 cm. It bounced a number of times as shown in the diagram below.



The height of its rebounds decreases. Which of the following is the explanation?

- (1) The kinetic energy of the basketball is greater than its potential energy.
- (2) The potential energy of the basketball was changed to heat and sound energy.
- (3) The kinetic energy and the potential energy of the basketball remain the same throughout the rebounds.
- (4) Some of the kinetic energy of the basketball was converted to sound and heat energy during the rebounds.

✓ 22. A candle is burning in a well lit room at night. Suddenly the lamps were switched off. Which of the following can be inferred from the situation?

- (1) Light can be bent.
- (2) Light travels in straight line.
- (3) Light gives off heat energy.
- (4) The burning candle is the source of light.

23.

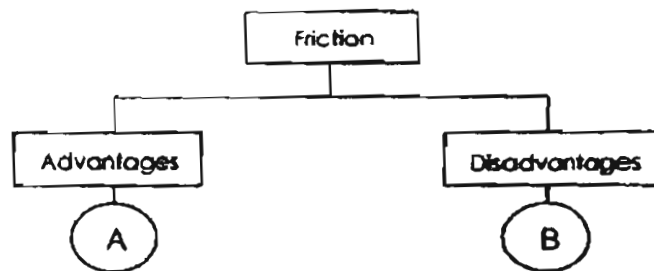

Which of the following examples below represent A and B?

	A	B
(1)	Brushing teeth	Sharpening pencils
(2)	Strumming a guitar	Erasing mistakes using an eraser
(3)	Swimming with a float	Machine parts rubbing against one another
(4)	Pushing a sofa across the room	Smoothering the wall with sand paper

24. The graph below shows how the length of a spring changes when different masses are hung on it.

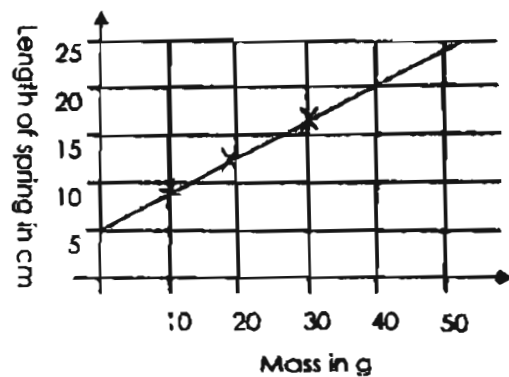

What is the extension of the spring when a 40 g mass is hung on it?

- (1) 15 cm
- (2) 17 cm
- (3) 20 cm
- (4) 22 cm

25.

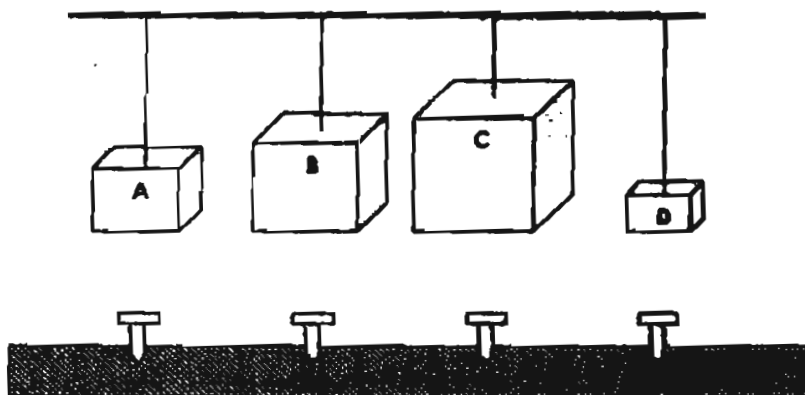

Four identical nails were placed on a piece of softwood as shown above. Four weights, A, B, C and D were dropped onto each nail. The length of each nail that went into the soft wood was measured.

Weight	Length of nail that went into the wood in cm
A	2.0
B	0.5
C	0.8
D	1.8

From the results of the experiment, which of the statements below is correct?

- (1) Weight C is the lightest.
- (2) Weight A is the heaviest.
- (3) Weight A is lighter than weight D
- (4) Weight B is heavier than weight C

26. These imaginary planets are composed of similar materials. The mass of these planets are proportionate to their sizes shown below.

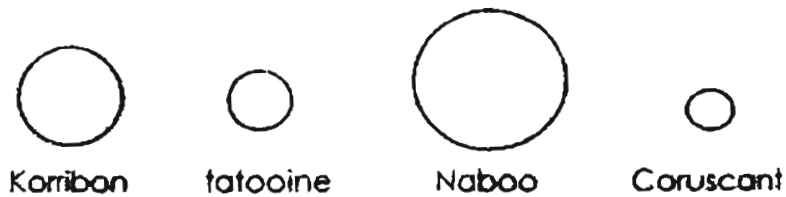

On which planet will a spaceship find it most difficult to take-off?

- (1) Korriban
- (2) tatoonine
- (3) Naboo
- (4) Coruscant

27.

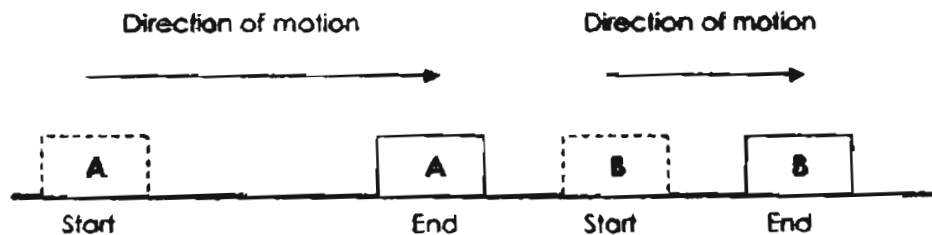

The diagram above shows two identical blocks of the same material pushed along the same surface. Block B travelled a shorter distance. Which of the following is/are possible explanation(s) for that?

- A: Block B was heavier than Block A
- B: A layer of oil was spread below Block A.
- C: A greater force was used to push Block A.

- (1) A only
- (2) C only
- (3) B and C only
- (4) A, B and C only

28. Elgin and Jia Cheng played a game on a pin ball machine. The drawing below shows how the pin ball was released. When the stretched striker was released, the pin ball moved forward. Jia Cheng's pin ball moved further than Elgin's.

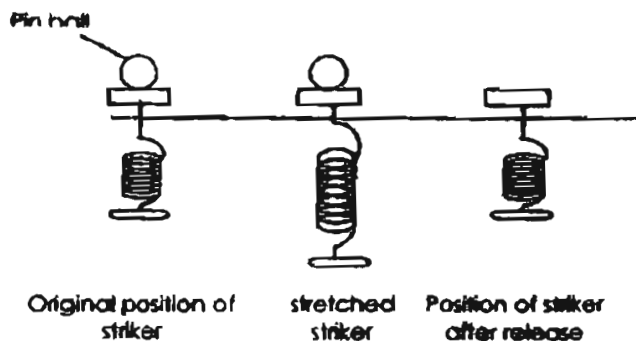

What caused Jia Cheng's pin ball to move further than Elgin's?

- (1) Elgin's spring had more kinetic energy.
- (2) Elgin's spring was shorter than Jia Cheng's.
- (3) Jia Cheng's spring was more elastic than Elgin's.
- (4) Jia Cheng's spring had more potential energy.

29. Which of the following shows the direction of friction acting on the ball in motion?

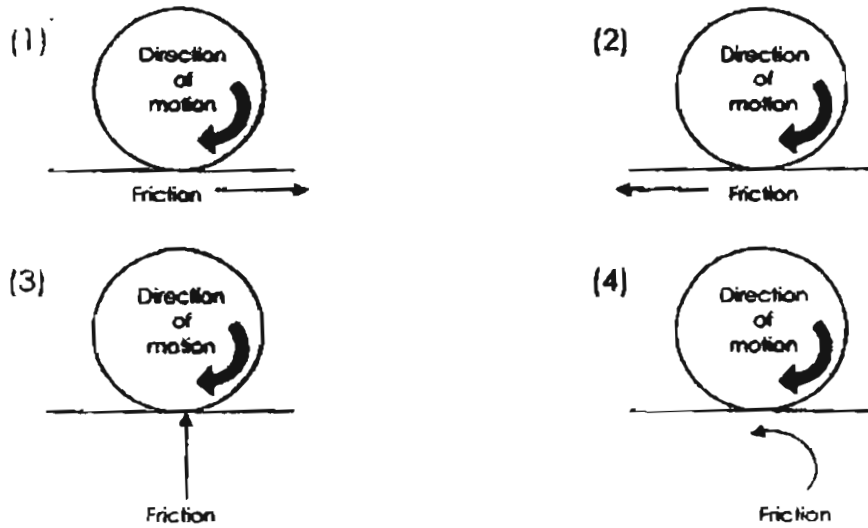

30. Two bars, X and Y, of the same diameter and length were wrapped tightly with paper as shown below. Each bar was heated over a flame for the same duration of time.



The paper on bar X was scorched but the paper on bar Y was not. What materials are X and Y most likely to be made of?

	X	Y
(1)	Iron	Wood
(2)	Wood	Copper
(3)	Wood	Glass
(4)	copper	iron

Name: _____ ()
Class: Primary 6 ()

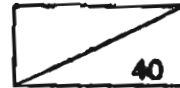

Section B (40 marks)

Write your answers for questions 31 to 46 in the spaces provided.

31. Fill in the blanks in the table below. (3 marks)

	Photosynthesis	Respiration
a) Identify the energy source.		
b) Identify the organisms.		
c) Identify the gases produced.		

32. Complete the table below to show the differences between inhaled and exhaled air in a human body. 2 of the differences are already described. List another 2 differences in the table below. (2 marks)

Inhaled air	Exhaled air
more oxygen	less oxygen
less carbon dioxide	more carbon dioxide

33. Study the skeletal system below.

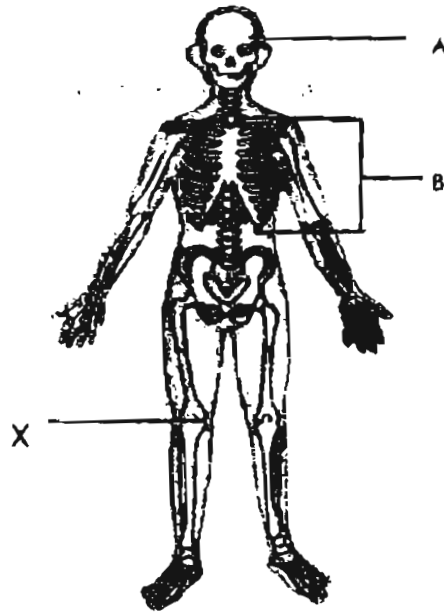

(a) Name the parts labelled A and B. Describe one function of each part in the table given below. (2 marks)

Part	Name	Function
A		
B		

(b) Name the type of joint found at X. (1 mark)

34.

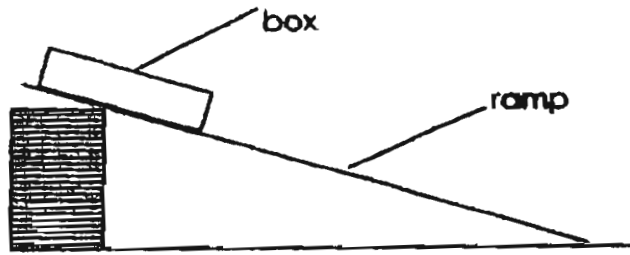

What is/are the force(s) acting on the stationary box? (2 marks)

35. You are given a metal rod. Describe the steps you would take to identify the following characteristics of the metal rod.

(a) The metal rod is made of a ~~non~~-magnetic material. (1 mark)

(b) The metal rod is made of a magnetic material. (1 mark)

(c) The metal rod is a magnet. (1 mark)

36. Two empty tins, P and Q, of identical size, were put under the sun together with a thermometer each as shown in the diagram below. One tin is painted white and the other black. The readings on the thermometers were taken every 3 minutes and recorded in the table below.

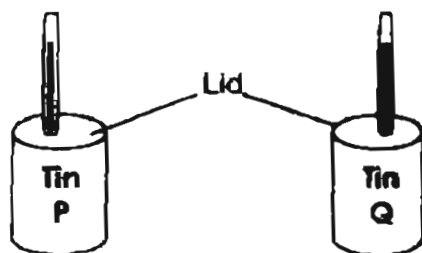

Time in min	0	3	6	9	12	15
Thermometer reading in tin P in °C	25	27	30	32	34	35
Thermometer reading in tin Q in °C	25	26	28	29	29	30

(a) Fill in the blanks with 'Black' or 'white' (1 mark)

Tin	Colour painted
P	
Q	

(b) Put a tick (✓) in the table below if the statement is 'True', 'False' or 'Not possible to tell'. (2 marks)

	True	False	Not possible to tell
i) Tin P has gained heat from Tin Q.			
ii) The black paint has produced heat for the air in Tin Q.			
iii) Tin Q has absorbed more heat than tin P in 15 minute.			
iv) The air in Tin P has gained more heat than the air in tin Q.			

37. The table below shows how a solution changes colour according to the amount of carbon dioxide present.

Colour of solution	Amount of carbon dioxide
Red	More carbon dioxide than in air
Yellow	Same amount of carbon dioxide as in air
Green	Lesser amount of carbon dioxide than in air

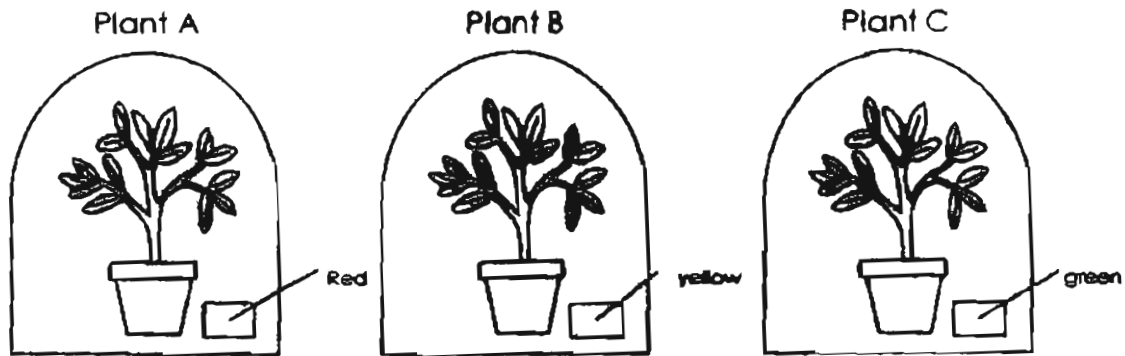

(a) If an iodine test is carried out, which plant will give a positive test? (1 mark)

(b) Explain your answer in part (a). (2 marks)

38. The diagram below shows a circuit with 4 metal rods connected to an instrument that measures the amount of electricity in the circuit.

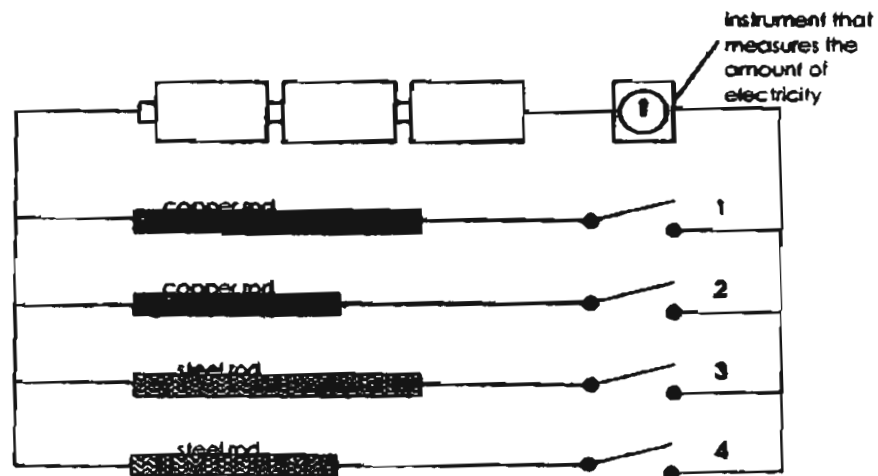

Elizabeth closed switch 1 and kept the other switches open. She then observed the reading on the instrument. She repeated the experiment by closing switches 2, 3 and 4 in turn. She made sure only one switch was closed at any one time.

- (a) List one possible aim of Elizabeth's experiment. (1 mark)

- (b) State one variable that was kept the same for the experiment to be a fair one. (1 mark)

39. A group of living things A, B, C, D, E and F are classified in the table below. Use the information in the table to answer the questions.

Make their own food		Find their own food	
Live in water	Live on land	Live in water	Live on land
A	B	C F	D E

(a) How is C similar to D? (1 mark)

(b) How is A similar to F? (1 mark)

(c) How is B different from E? (1 mark)

40. Study the list of items below.

Mirror	Aluminium foil	Clear food wrap	Copper wire
Test tube	Tracing paper	One dollar coin	Safety pin

(a) What property will you use to group the items such that there are 4 items in each group? (1 mark)

(b) State another property you will use to re-group the items into 2 groups such that there is 3 in one group, 5 in another group. (1 mark)

41. The circuit shown below was left closed to keep the bulb lighted up. After some time, the bulb did not light up.

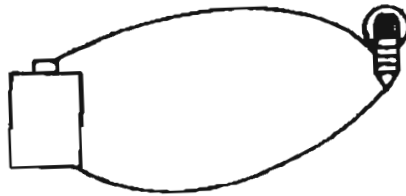

(a) Identify the source of energy in the above diagram? (1 mark)

(b) What can you say about the source of energy over a period of time? (1 mark)

42. Study the diagram below. When Yvett placed object Q near the magnet, the ping pong ball was pushed off the table by the magnet.

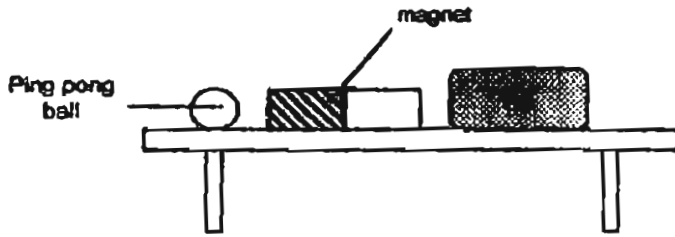

(a) What is object Q? (1 mark)

(b) What must be done to object Q if it is to be brought near the magnet without causing the ping pong ball to move? (1 mark)

43. Study the diagram below.

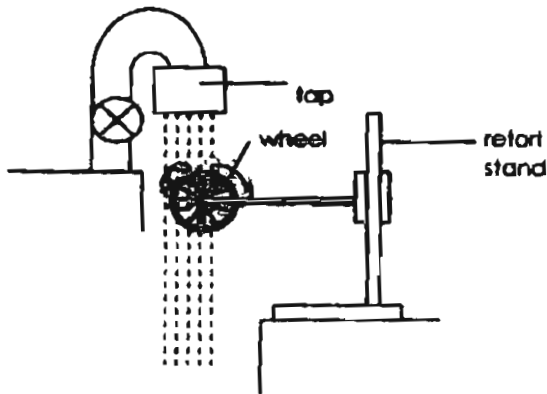

State two ways to make the wheel spin faster. (Use only the same set-up)

(2 marks)

i)

ii)

44. The lengths of a spring when different weights were placed on it are recorded below.

(a) Calculate the extension of the spring. (1 mark)

Mass in g	Length in cm	Extension in cm
0	10	
10	12	
20	14	
30	16	
40	18	
50	20	

(b) Plot a graph to show the extension of the spring. (2 marks)

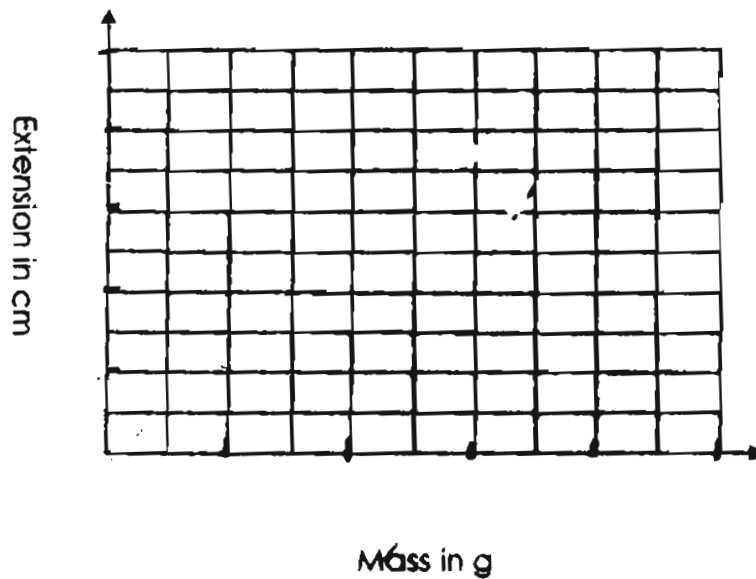

(c) From the graph, determine the extension of the spring when a mass of 35g is placed on it. (1 mark)

45.

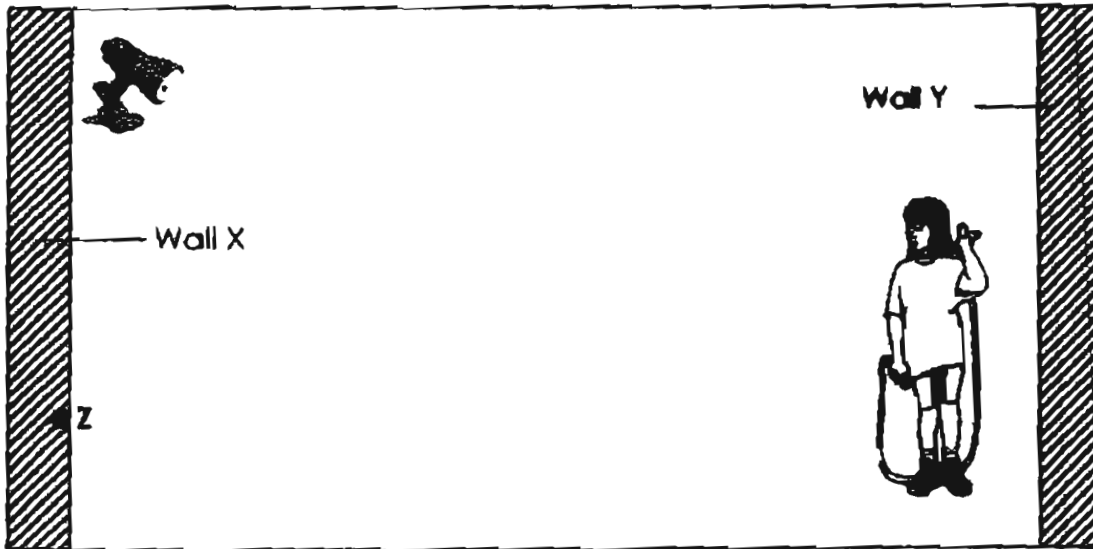

The diagram above shows a girl standing between 2 walls (x and Y). A light source is placed on wall X.

(a) What would happen to the length of her shadow cast on the wall Y if she walks towards the light source? (1 mark)

(b) What would happen to the length of her shadow cast on the wall Y if she walks towards the light source when the position of the light source was changed to Z? (1 mark)

46. The diagram below shows a magnet which pulls a paper clip up when suspended above it.

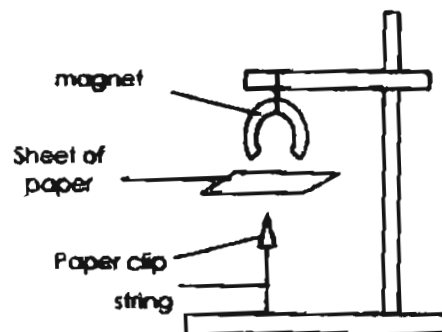

- (a) The paper clip did not fall when a piece of paper is placed between it and the magnet. Why? (1 mark)

- (b) What could happen to the paper clip if the piece of paper is replaced by an iron sheet? (1 mark)

End of paper

TAO NAN SCHOOL
PRIMARY SIX
SCIENCE
MID YEAR EXAMINATION - 2005

- | | | |
|---------|---------|---------|
| 01. 4 | 11. 3 | 21. 4 |
| 02. 4 | 12. 3 | 22. 4 |
| 03. 2 | 13. 4 | 23. 3 |
| 04. 3 | 14. 2 | 24. 1 |
| 05. 2 | 15. 3 | 25. 2 |
| 06. (4) | 16. 4 | 26. (3) |
| 07. 2 | 17. (3) | 27. (3) |
| 08. (2) | 18. 3 | 28. (4) |
| 09. 3 | 19. 4 | 29. 1 |
| 10. 4 | 20. 3 | 30. 2 |

- 31) a) sun food
 b) plants plants, animals
 c) oxygen carbon dioxide.
- 32) cool warm
 Not so clean more clean
- 33) Skull It protects the brain
 Ribcage It protects the hearts and lungs.
 b) Hinge joint
- 34) Gravitational force and frictional force.
- 35) a) Place a magnet near the metal rod. If it is not attracted to the metal rod, it is made of a non-magnetic material.
 b) Place a magnet near the metal rod. If it is attracted to the metal rod, it is made of a magnetic material
 c) Place a steel rod beside the metal rod. If the steel rod is attracted to the metal rod, the metal rod is a magnet.
- 36) a) Black
 White
 b)

	✓	
	✓	
	✓	
✓		
- 37) a) Plant C
 b) Plant C is taking in carbon dioxide from the air to make food which is starch. That is why there is less carbon dioxide in the air. When there is a presence of starch, iodine will change from brown to dark blue, which gives a positive test.

- 38) a) To investigate whether different length of metal rods will affect the amount of electricity flowing in a circuit.
- b) The thickness of the metal rods.
- 39) a) Both C and D find their own food.
- b) Both A and F live in water.
- c) B makes their own food while E finds their own food.
- 40) a) Whether they are metal or non-metal.
- b) Metal and non-metal.
- 41) a) Battery b) The chemical energy was used up.
- 42) a) Object Q is a magnet.
- b) Object Q must be turned around so that the magnet and Object Q are facing each other with unlike poles.
- 43) i) Adjust the tap so that more water gushes out.
- ii) Place the wheel further down the retort stand.
- 44) a) 0
- 2
- 4
- 6
- 8
- 10
- b)
- c) 7 cm
- 45) a) It will be bigger
- b) Her shadow will become longer
- 46) a) The magnetic force was strong enough to pass through the paper.
- b) The paper clip would fall.