

NANYANG PRIMARY SCHOOL
PRIMARY 6 SCIENCE
PRELIMINARY EXAMINATION



Date : 25 August 2005

Duration : 1 h 45 min

Name: _____ ()

Class: Primary _____ ()

Marks Scored

Booklet A		60
Booklet B		40
Total		100

Parent's Signature : _____

DO NOT OPEN THIS BOOKLET UNTIL YOU ARE TOLD TO DO SO.
FOLLOW ALL INSTRUCTIONS CAREFULLY.

Section A (60marks)

For each question from 1 to 30, four options are given. One of them is the correct answer. Make your choice (1, 2, 3 or 4).

Shade the correct oval (1, 2, 3 or 4) on the Optical Answer Sheet.

1. Study the classification table below.

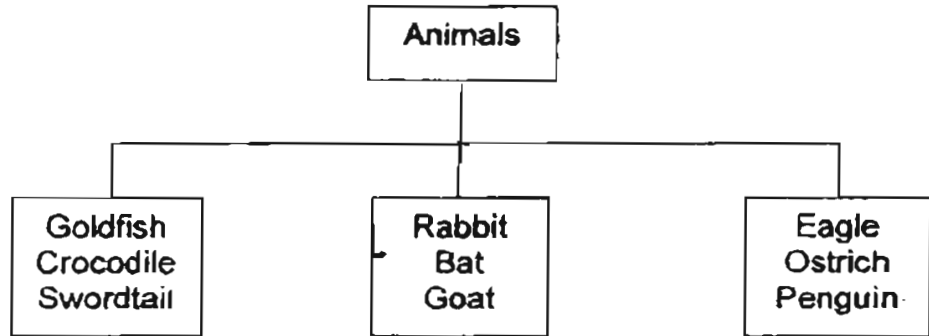

How are the animals above grouped?

- (1) according to the way they move
- (2) according to their body coverings
- (3) according to the way they reproduce
- (4) according to the type of food they eat ()

2. The table below shows some animals which are grouped according to their habitats.

Habitat	Animals
P	dolphin, jellyfish, starfish
R	earthworm, wood louse, centipede
S	grasshopper, butterfly, spider
T	snakehead, mosquito larva, dragonfly nymph

In which one of these habitats are you most likely to find a praying mantis?

- (1) P
- (2) R
- (3) S
- (4) T ()

3. Study the flowchart below.

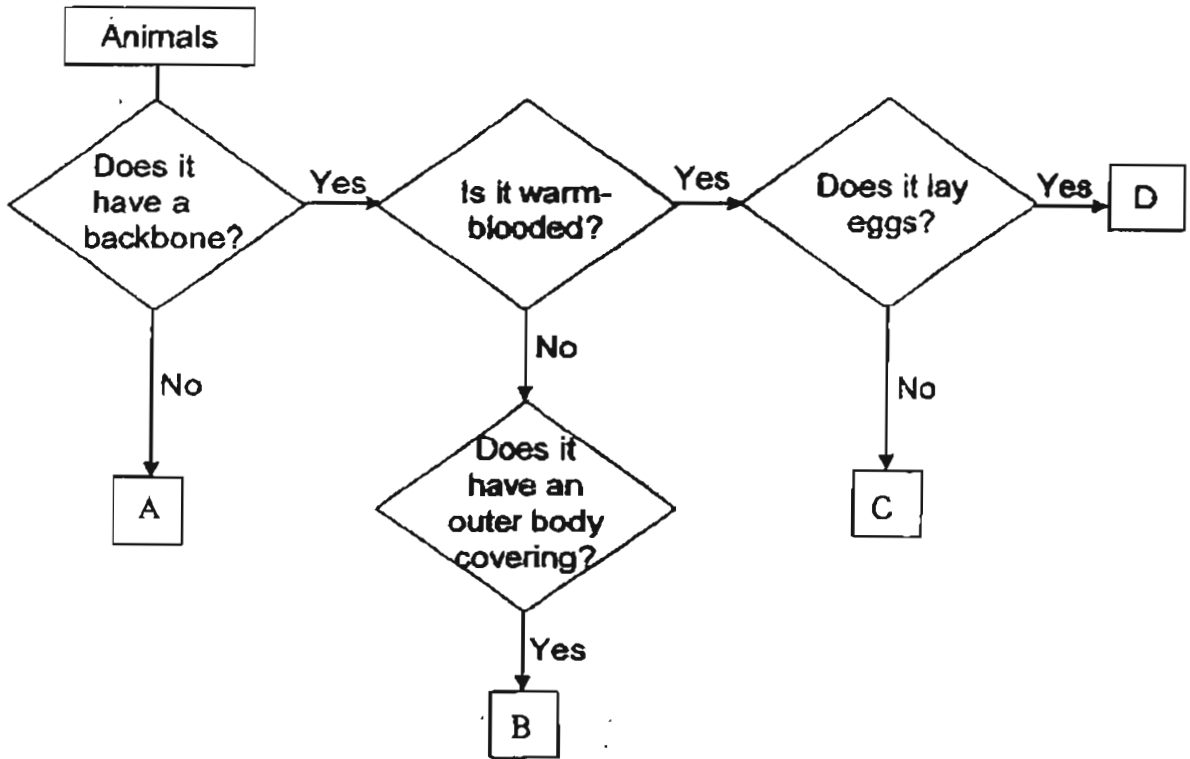

Which of the following can be represented by A, B, C and D?

	A	B	C	D
(1)	earthworm	snake	platypus	pigeon
(2)	ant	turtle	walrus	platypus
(3)	earthworm	seal	swordtail	snake
(4)	ant	shark	cockroach	vulture

()

4. Study the graphic organizer below.

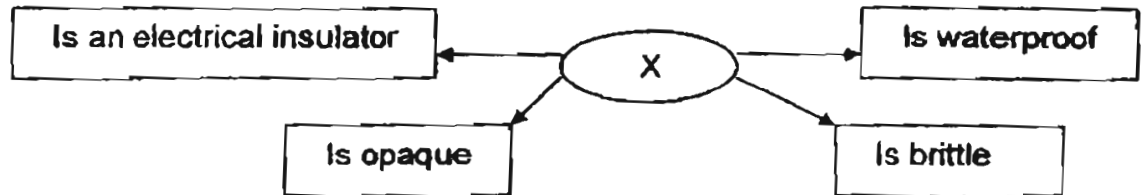

Which one of the following is object X most likely to be?

- (1) twig
- (2) towel
- (3) copper coin
- (4) porcelain cup

()

5. Below are statements about Fungi made by four pupils.

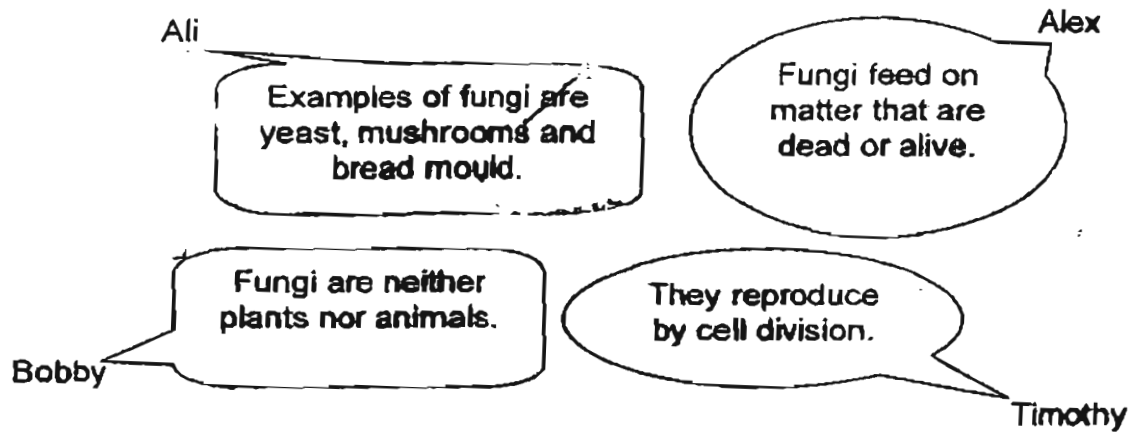

Which one of the pupils has made a wrong statement?

- (1) Ali only
- (2) Alex only
- (3) Bobby only
- (4) Timothy only

()

6. Study the diagram of the water cycle as shown below.

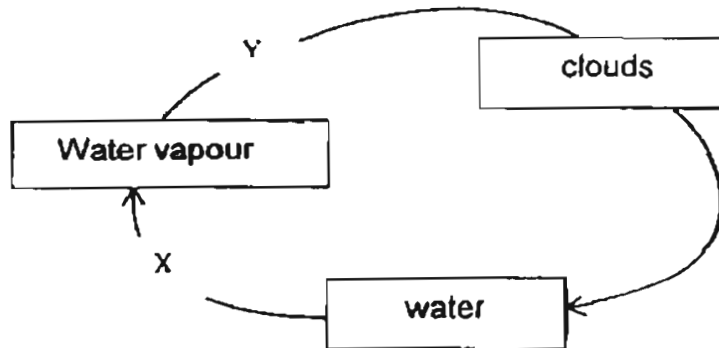

Which one of the following statement(s) about the water cycle is/are correct?

A.	At stage X, the water loses heat to the surroundings.
B	At stage X, the water gains heat from the surroundings.
C	At stage Y, the water vapour loses heat to the surroundings.
D	At stage Y, the water vapour gains heat from the surroundings.

- (1) A only
 (2) B only
 (3) A and D only
 (4) B and C only ()

7. An experiment was conducted using a spring balance. Its original length was 7 cm. Different weights were added and the lengths of the spring were measured.

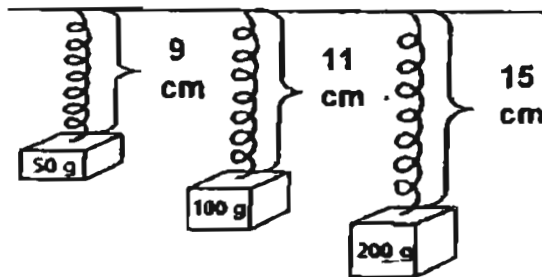

What would be the extension of the spring when the load was 125g?

- (1) 2 cm
 (2) 3 cm
 (3) 4 cm
 (4) 5 cm ()

8. Azizah set up the circuit below. She was told that one of the objects A, B, C or D in the circuit was an electrical insulator.

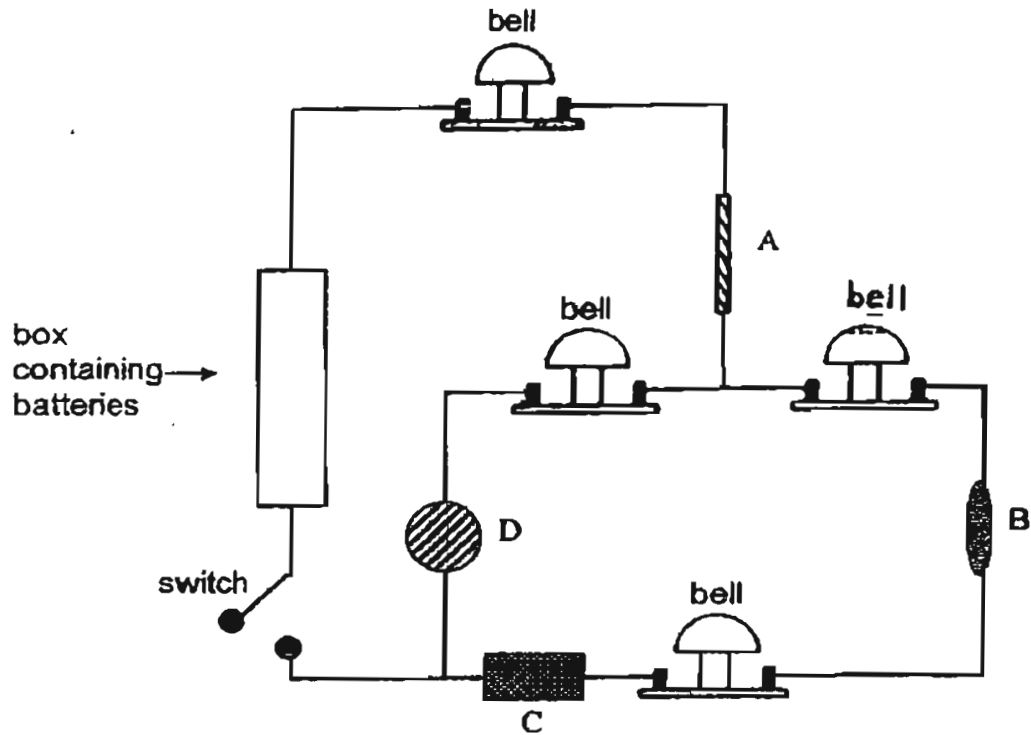

When she closed the switch, she observed that only 3 bells in the circuit rang.

Which one of the 4 objects, A, B, C or D, was the insulator?

- (1) A
- (2) B
- (3) C
- (4) D

()

9. Study the diagrams of the machines below.

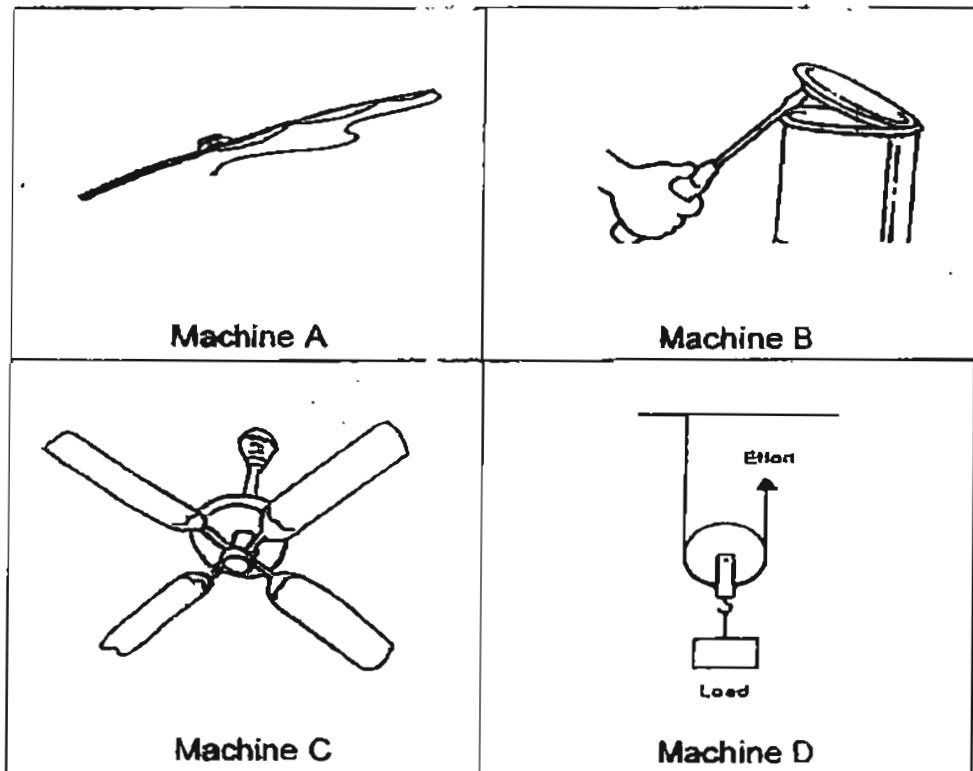

When these machines are in use, they satisfy certain conditions as listed in the table below:

The effort moves a shorter distance than the load.
The effort and the load move in the same direction.
The effort needed to move the load is larger than the load.

Which of these machines, A, B, C or D, satisfies/satisfy all the 3 conditions listed above?

- (1) Machine A only
- (2) Machine B only
- (3) Machines A and C only
- (4) Machines A and D only

()

10. Study the set-up below.

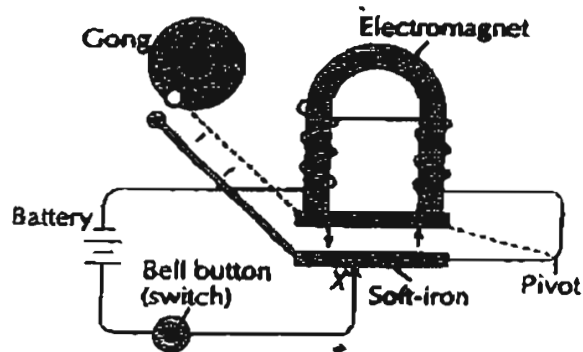

Which is the energy change when the bell button is pressed?

- (1) Chemical energy \rightarrow kinetic energy \rightarrow sound energy + heat energy
- (2) Chemical energy \rightarrow electrical energy \rightarrow kinetic energy \rightarrow sound energy + heat energy
- (3) Chemical energy \rightarrow electrical energy \rightarrow kinetic energy + sound energy + heat energy
- (4) Chemical energy \rightarrow kinetic energy \rightarrow electrical energy + sound energy + heat energy

()

11. Which one of the following is not an energy source?

- (1) oil
- (2) sun
- (3) rock
- (4) waterfall

()

12. Tom wanted to compare the shadows cast by objects X and Y. He carried out the following experiment with object X and drew the shadows that were formed as he shifted the position of the object. Then he repeated the experiment with object Y.

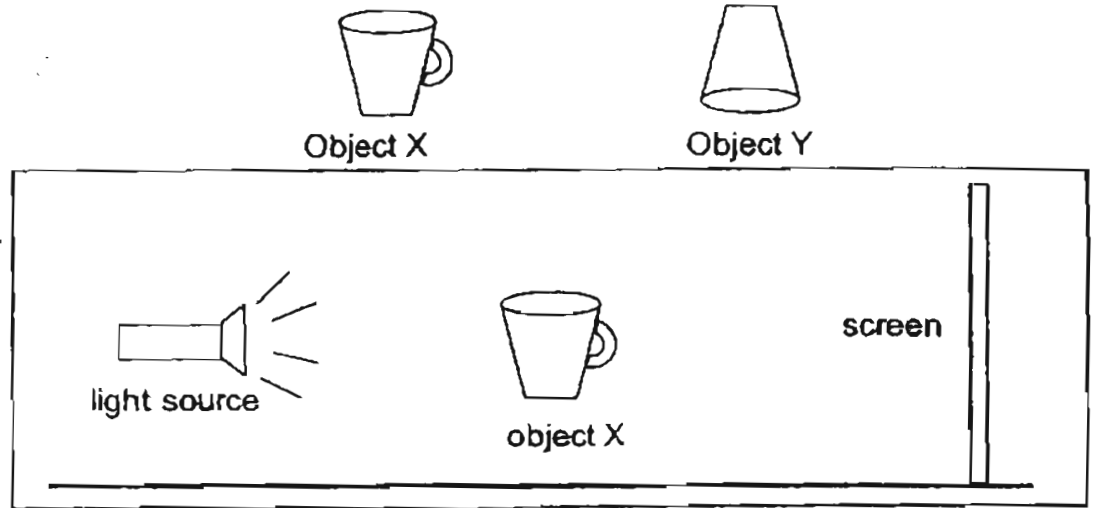

Some shadows formed by the two objects were shown below. Which of these shadows was/were seen for both objects X and Y ?

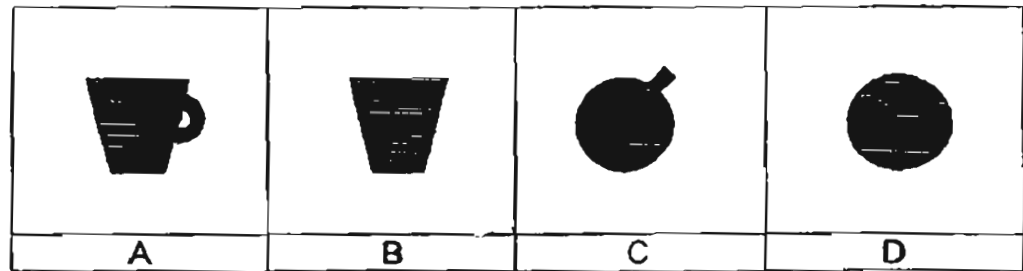

- (1) A only
 (2) B only
 (3) C only
 (4) B and D only

()

13. In which of the following description(s) is/are friction being put to good use?

- A A tyre becoming bald
 B A car coming to a stop
 C A knife being sharpened
 D A nail holding 2 wooden boards together

- (1) A only
 (2) B only
 (3) A and C only
 (4) B, C and D only

()

14. Siti carried out the experiment shown below.

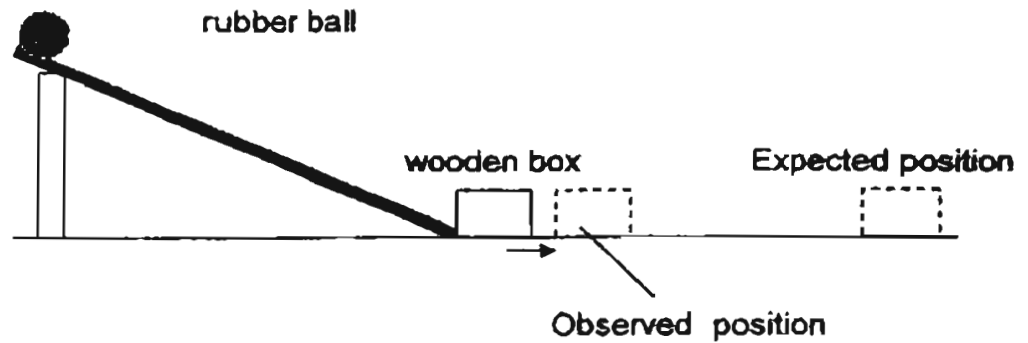

When she released the rubber ball, the box did not move as far as she had expected. What could she do to the set-up to ensure that the box would reach the expected position or beyond?

- A Use a heavier ball.
- B Smoothen the ramp.
- C Let the box stand on its smallest face.
- D Lower the starting position of the ball.

- (1) A only
- (2) A and B only
- (3) B and C only
- (4) C and D only

()

15. Which one of the following does not give out light?

- (1) fire
- (2) star
- (3) Sun
- (4) moon

()

16. The diagram below shows part of a ginger and carrot.

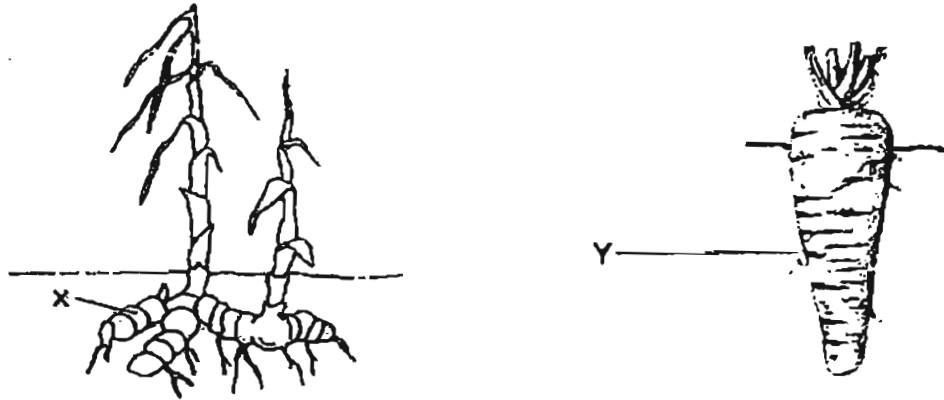

Which of the following statements correctly state the similarities between part X and Y ?

- A. Both parts store food.
- B. Both parts are underground stems.
- C. Both parts absorb water and minerals salts.
- D. Both parts provide additional anchorage to the plant .

- (1) A and D only
- (2) B and C only
- (3) A, B, and C only
- (4) A, B, C and D

(5)

17. Which of the following statements(s) about a pond community is/are definitely true ?

- A. All the fishes form a population.
- B. All the living things in the pond form a community
- C. All the floating and submerged plants form a population
- D. All insects that breathe through air bubbles form a population.

- (1) B only
- (2) C and D only
- (3) A and D only
- (4) A, B,C and D

()

18. Which one of the following diagrams correctly shows the exchange of gases between living things and the surroundings at night?

(1)

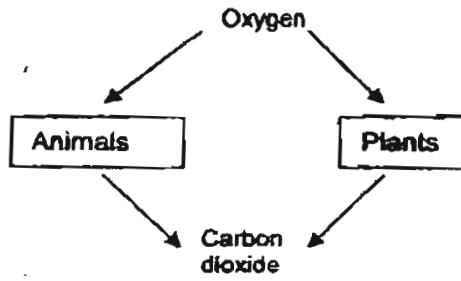

(2)

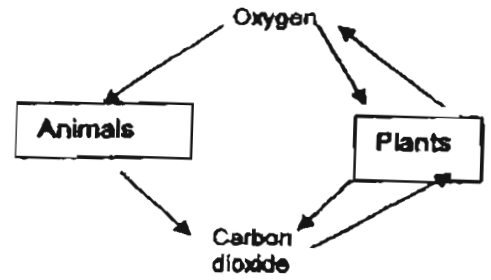

(3)

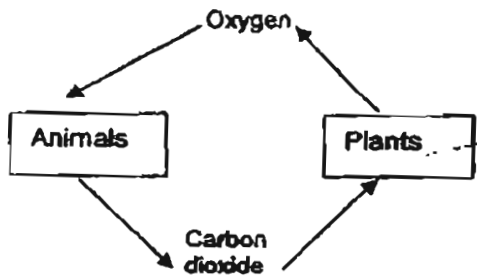

(4)

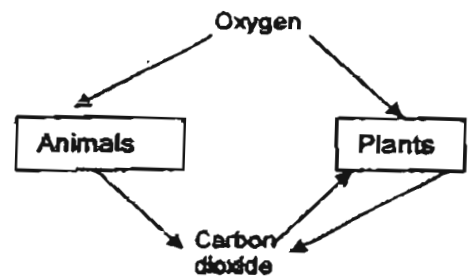

()

19. Which one of the following graphs below correctly shows the interaction between 2 factors found in the environment?

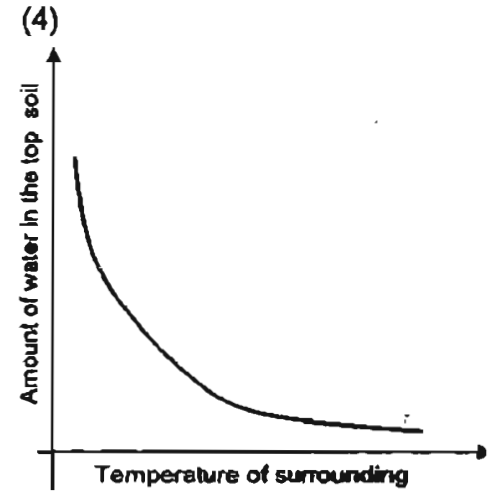
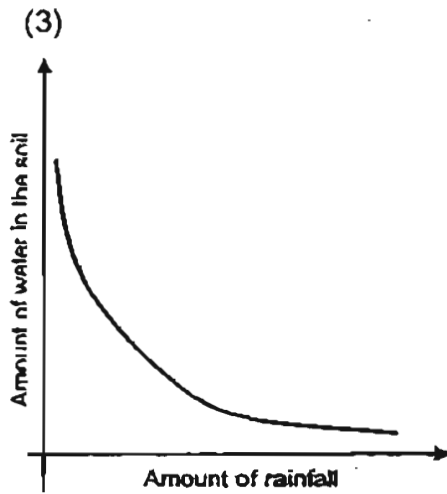
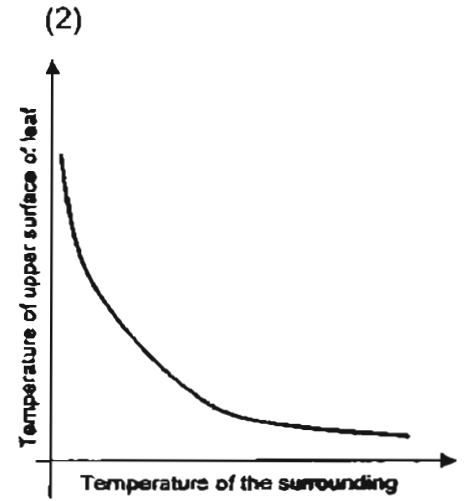
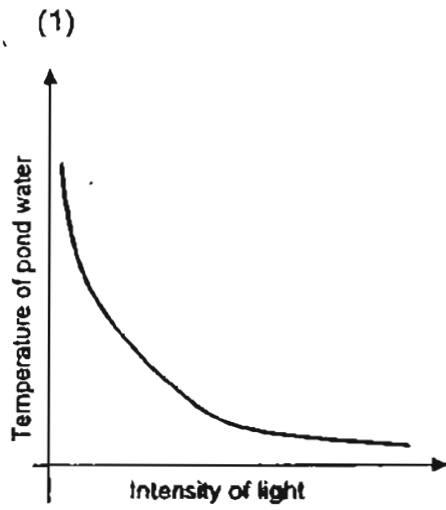

()

For Questions 20 and 21, refer to the food web shown below:

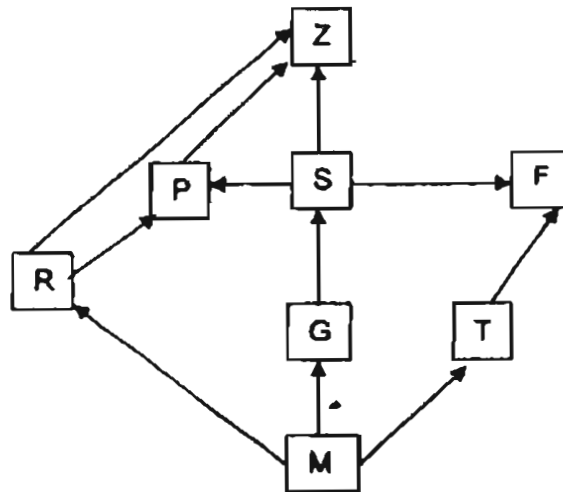

20. Which one of the following shows the correct grouping ^{for} the various organisms in the food web ?

	Prey only	Predator only	Both prey and predator
(1)	M,R,G,T	Z	P,S,F
(2)	M,G	F	P,T
(3)	R,G,T	Z,F	P,S
(4)	R,T,S	P	F,Z,G

()

21. How many food chains are there in the food web?

- (1) 5
- (2) 6
- (3) 7
- (4) 8

()

22. Minah wanted to find if dead maggots produce carbon dioxide. She placed 5 dead maggots in a container and attached a delivery tube, linking a tube of limewater to the container.

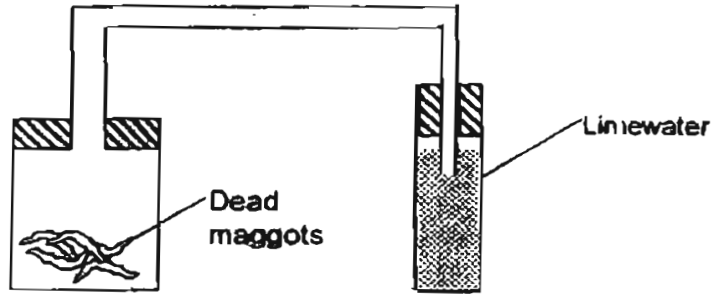

Which one of the following set-ups could be used as a control for her experiment ?

(1)

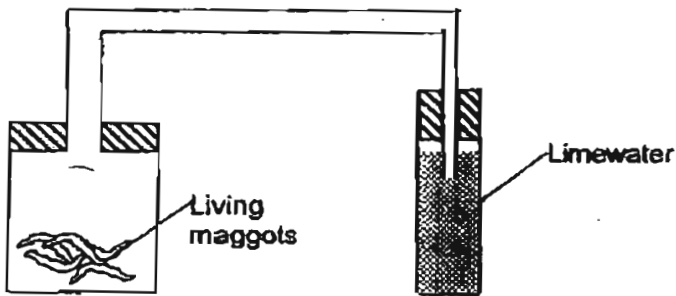

(2)

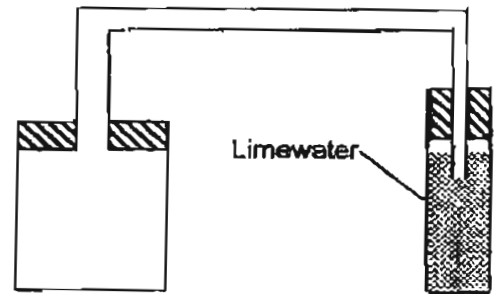

(3)

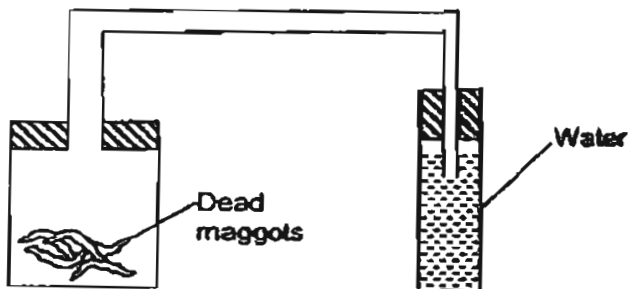

(4)

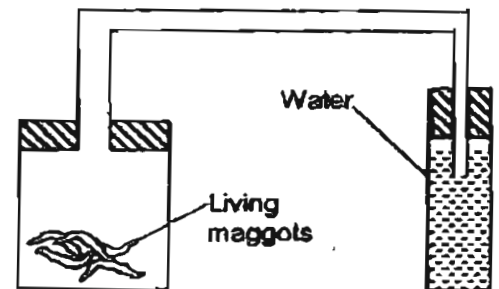

()

23.

An experiment was carried out using 2 groups of red bean seeds. One group of seeds was grown in the presence of light and the other grown in the dark. The rest of the conditions were kept the same for both groups of seeds. The average heights of the seedlings of the seedlings over 10 days were as shown below.

Days	Average height of seedlings (mm)	
	Grown in light	Grown in dark
2	3	5
4	7	9
6	14	20
8	22	34
10	33	49

Another experiment was carried out with red bean seeds again but this time the seeds were grown in the dark for 6 days before transferred into light and continued to be grown for another 4 days. The rest of the conditions were similar to the previous experiment. The average heights of the seedlings over 10 days were as shown below.

Days	Average height of seedlings (mm)
2	4
4	8
6	P
8	28
10	Q

Which of the following pairs of readings are most likely to be P and Q ?

	P	Q
(1)	10	35
(2)	20	39
(3)	8	28
(4)	16	54

()

24. Which one of the following statements is true ?

- (1) A plant cell has a cell wall but no cell membrane.
- (2) A plant cell divides faster because it does not have cytoplasm.
- (3) Starch may be found in the plant cell but not in an animal cell.
- (4) An animal cell does not require energy because it does not have chloroplasts to trap light energy. ()

25. Which one of the following adaptive features of the various organisms is correctly matched with its function ?

	Name of organism	Adaptive feature	Function of adaptive feature
(1)	Polar Bear	Stiff hairs on underside of paws	For fast gliding movement on ice
(2)	House lizard	Long sticky tongue	To catch prey easily
(3)	Grasshopper	Has a green body	To camouflage from prey
(4)	Pitcher plant	Leaf modified as pitcher	To trap insects as food

()

26. Some pond animals are grouped as shown below.

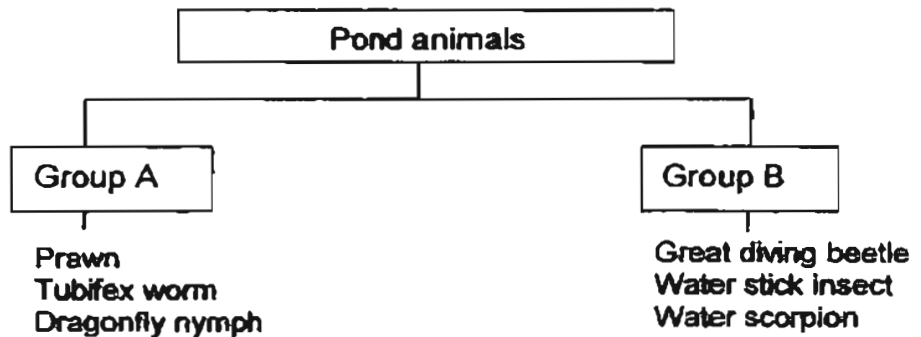

What are the characteristics used to group the animals into group A and B ?

	Group A	Group B
(1)	Herbivores	Omnivores
(2)	Breathe through gills	Breathe through breathing tube
(3)	Breathe in dissolved oxygen	Breathe in atmospheric oxygen
(4)	Found at any part of the pond	Found only on the surface of the pond

()

27. Which one of the following plants is not a climber ?

- (1) Bougainvillea (2) Sweet potato
(3) Money plant (4) Morning glory

()

28. The diagram below shows part of the skeleton of an animal W.



Based only on the diagram, which of the following statement(s) is/are definitely true about W ?

- A. It breathes through lungs.
- B. It is a mammal.
- C. It lives on land.
- D. It cannot fly.

- (1) A only
- (2) B and D only
- (3) B and C only
- (4) A, C and D only

()

29. Below is a simplified diagram of the circulatory system of man. The arrows represent blood vessels in the body.

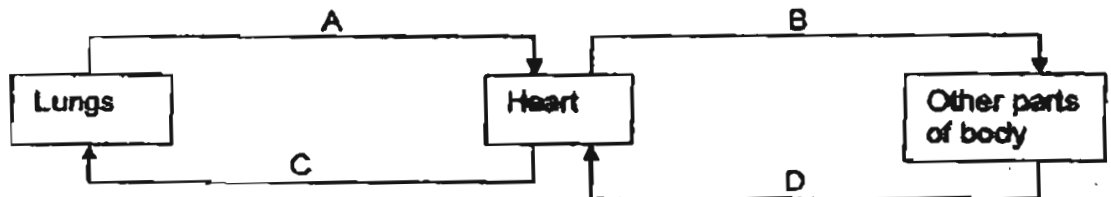



Which pairs of blood vessels are rich in carbon dioxide and poor in oxygen ?

- (1) A and B
- (2) A and D
- (3) B and C
- (4) C and D

()

30. Which one of the following bar charts best represents the composition of nitrogen, oxygen and carbon dioxide in inhaled and exhaled air?

 In inhaled air
 In exhaled air

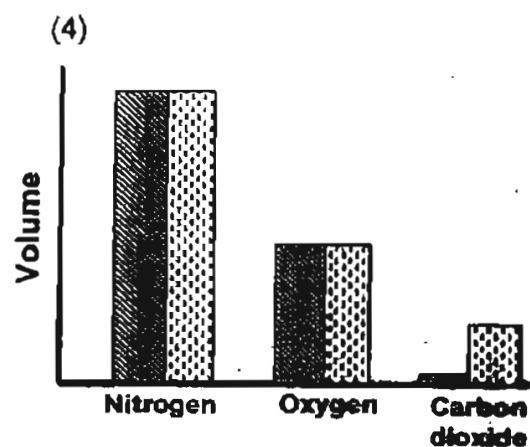
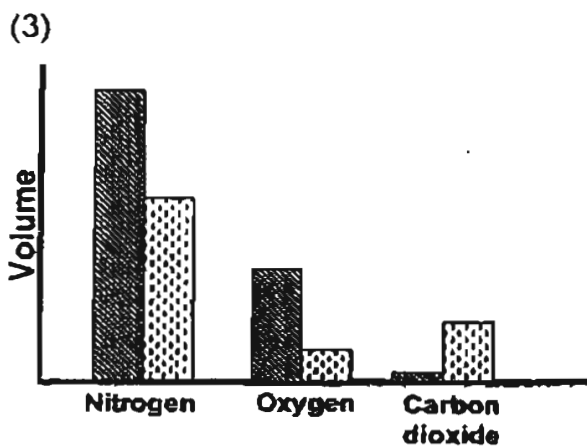
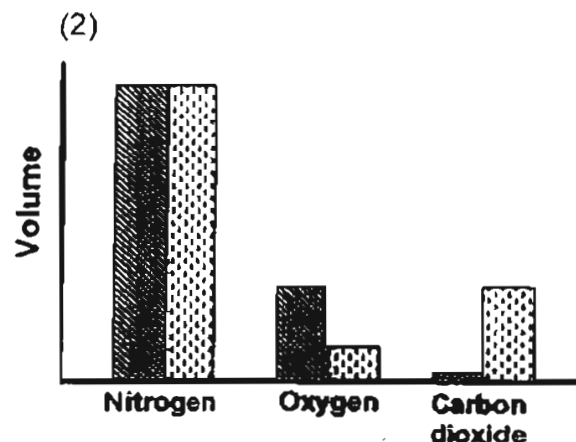
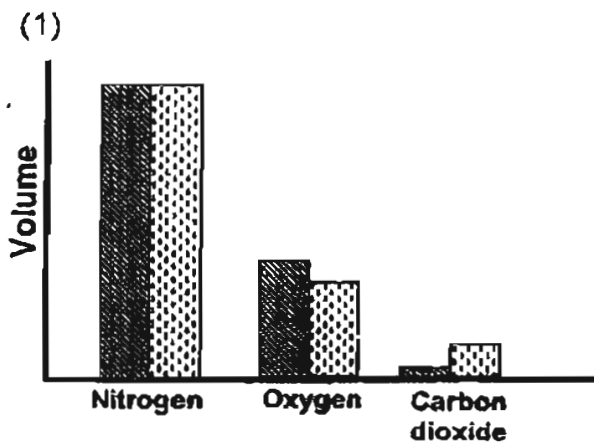

()

**NANYANG PRIMARY SCHOOL
PRIMARY 6 SCIENCE
PRELIMINARY EXAMINATION**



Date : 25 August 2005

Duration : 1 h 45 min

Name: _____ ()

Class: Primary _____ ()

Marks Scored

Booklet A		60
Booklet B		40
Total		100

Parent's Signature : _____

**DO NOT OPEN THIS BOOKLET UNTIL YOU ARE TOLD TO DO SO.
FOLLOW ALL INSTRUCTIONS CAREFULLY.**

Section B (40marks)

Write your answers to questions 31 to 46 in this booklet.

31. Diagram 1 below showed three beakers, X, Y and Z containing small stones, water and oil respectively.

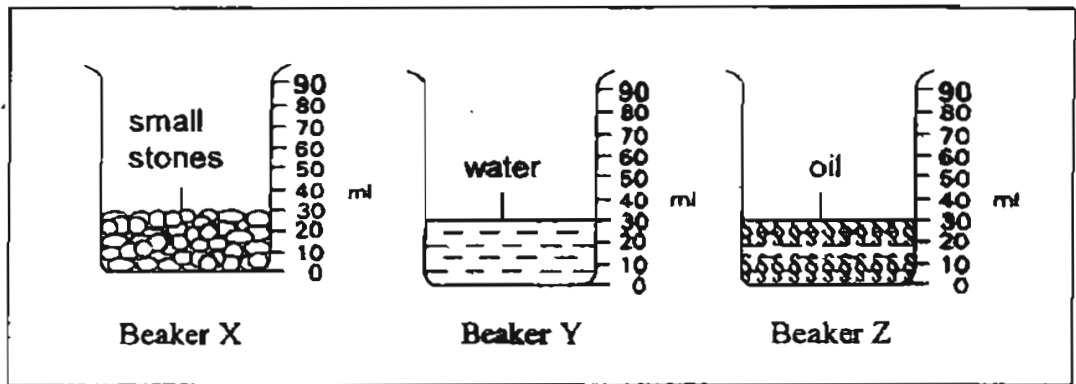

Diagram 1

- (a) Contents in Beakers Y and Z were poured into Beaker X. In Diagram 2 below, draw and label the contents after they had settled in Beaker X, given that the final level of the contents was 75 ml.

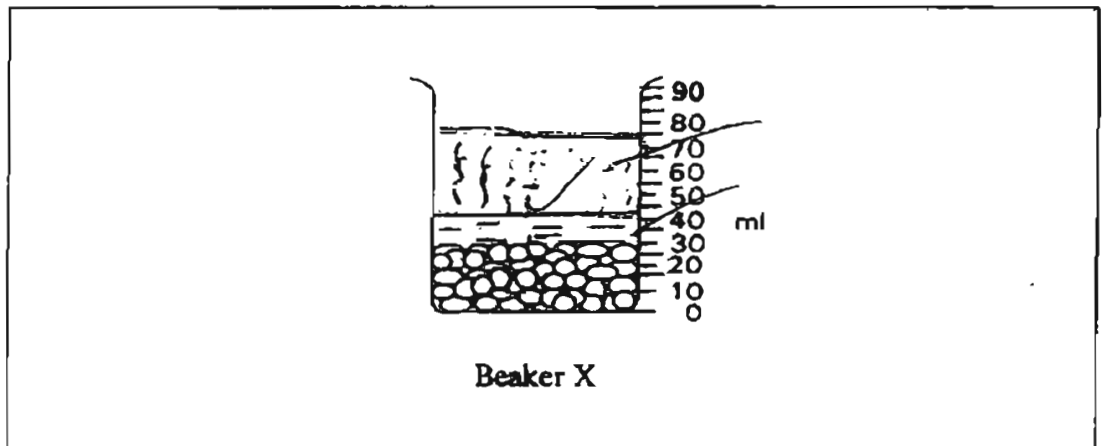

Diagram 2

- (b) Write down two properties of matter illustrated in Diagram 2 after the contents had settled. [2]

- (i) _____

- (ii) _____

32. Study the 2 gear systems below.

System A

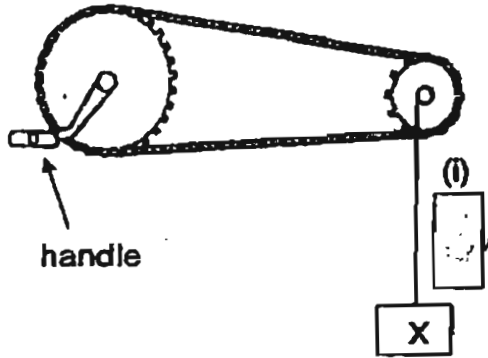

System B

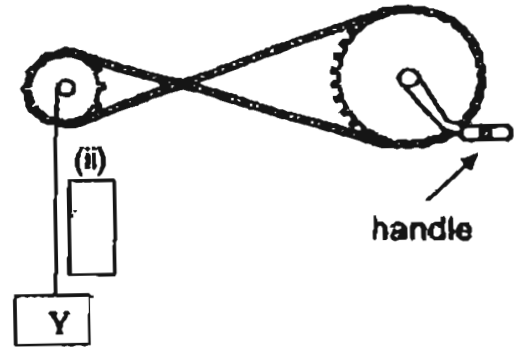

- (a) If the handles of both systems are turned clockwise, the loads, X and Y, will also move. Draw the direction of their movements in the boxes (i) and (ii) provided above. [1]
- (b) State and explain how these gear systems make work easier. [1]

33. Kenny used the same setup as shown below to find out how fast water can pass through 4 different soil samples A, B, C and D.

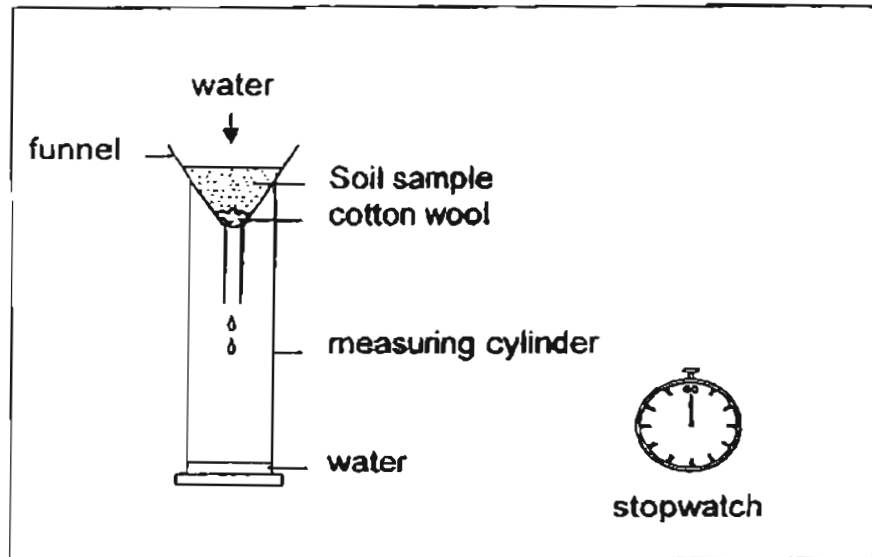

He measured the time taken for the water to collect in the measuring cylinder and recorded them in the table below.

Soil samples	A	B	C	D
Time taken (s)	38	20	34	13

- (a) Write down a variable which must be kept constant for the experiment.

[1]

(Question 33 is to be continued on the next page)

33(b) (i) Which one of the soil samples, A, B, C or D, is most suitable for a plant to grow well in the sandy desert? [1]

(ii) Put a tick in the correct box(es) below to show the type of root system which is most suitable for such a plant in b(i). [1]

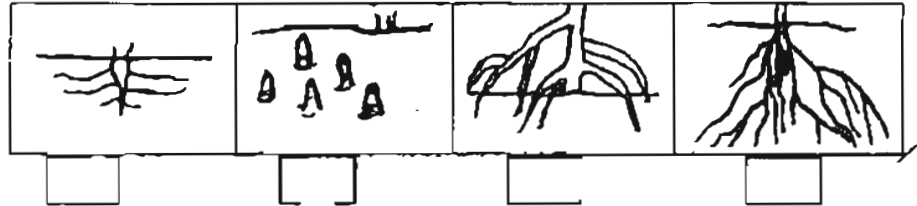

(iii) Explain your answer in (ii). [1]

34. Ali and Siti were comparing their new torchlights.

Ali: My torchlight is bigger. It will certainly shine more brightly than yours!

Siti: No, that may not be true although we are using new batteries. Let's switch on the torchlights.

Ali: You're right. My light is dimmer than yours!

State and explain 2 possible reasons why Ali's torchlight was dimmer than Siti's torchlight. [2]

(a) _____

(b) _____

35. Amat dropped a plastic ball from a height of 1 metre above the ground. It bounced to a lower height each time it hit the ground, as shown below until it finally stopped.

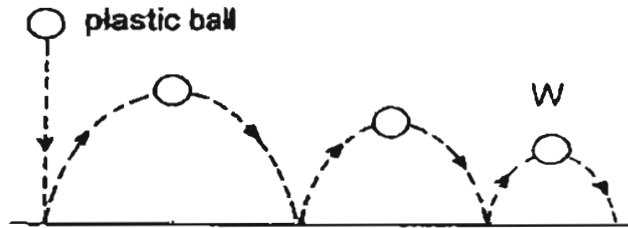

- (a) Identify the force that was acting continuously on the ball. [1]

- (b) (i) Apart from the sound produced, what difference would be observed if Amat used a similar-sized hollow rubber ball instead? [1]

- (ii) Explain your answer in (i). [1]

36. Meimei used similar wires and batteries of the same voltage to conduct 3 experiments using the setups shown below

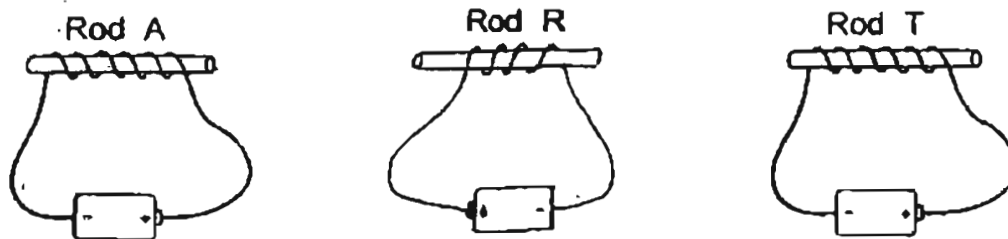

He recorded the number of paper clips that were attracted to each rod in the table below.

Rod	A	B R	C T
No. of paper clips	6	3	0

Write down 2 possible explanations for the difference in results for the following rods: [2]

- (a) A and R

- (b) A and T

37. Study the classification table and fill in the boxes.

[2]

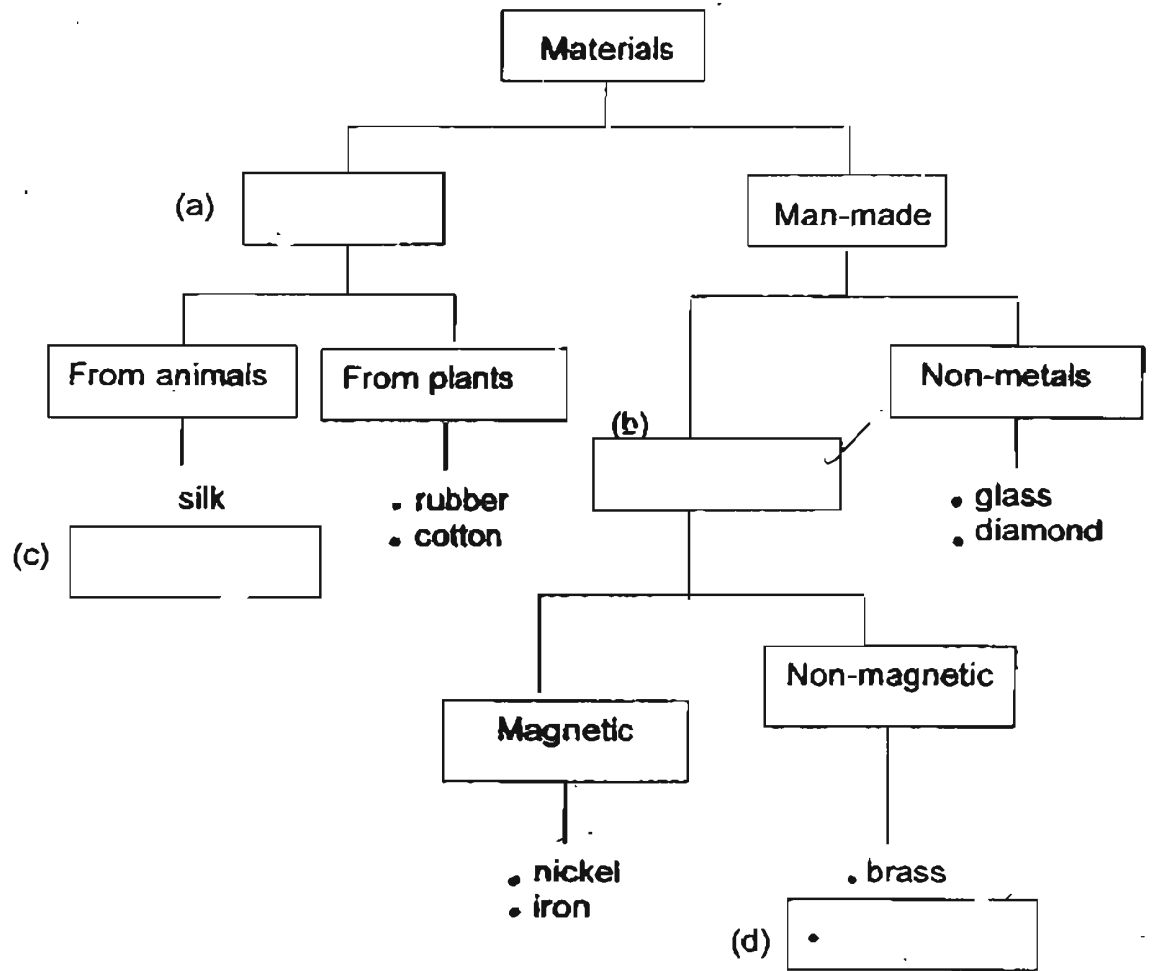

38. Study the set-up below.

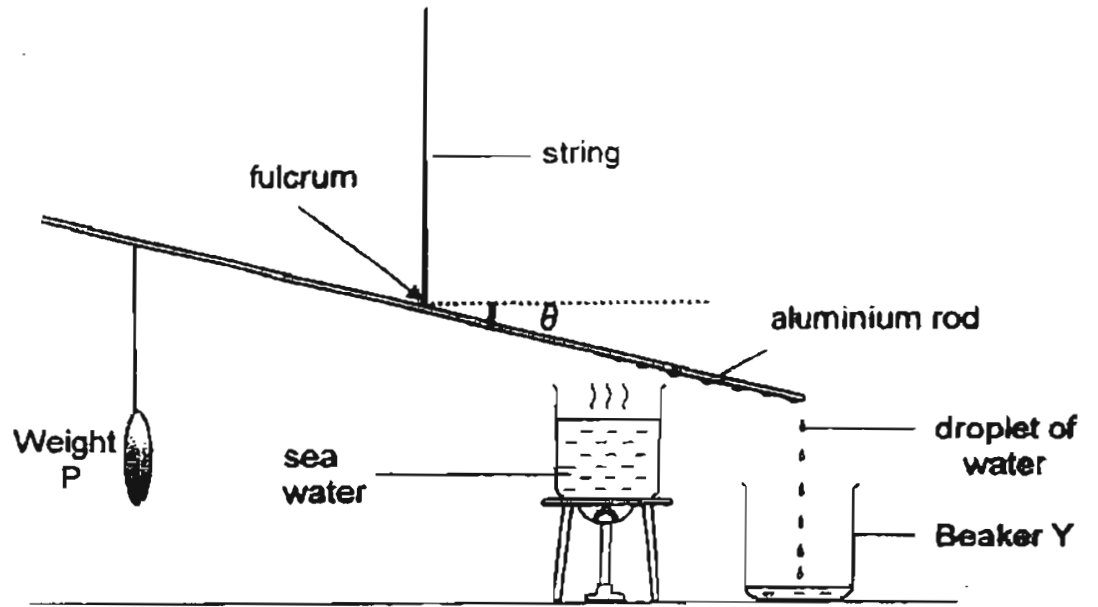

State 2 ways in which we can decrease the angle θ without changing the rod and the weight. [2]

(a) _____

(b) _____

39. Explain how the accumulation of greenhouse gases in the atmosphere would lead to global warming. [2]

40. (a) Explain why the young of some animals survive well because they live with their parents. [1]

(b) Explain why it is better for young plants to grow far away from their parent plant. [1]

41. The graphs below show the pattern of growth of a fish and an insect to adulthood.

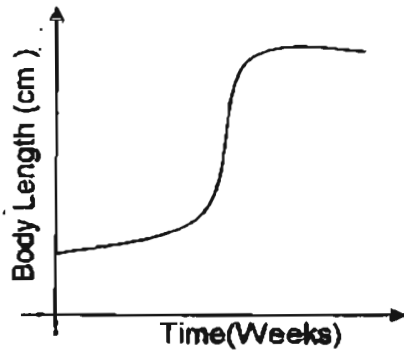

Growth pattern of fish

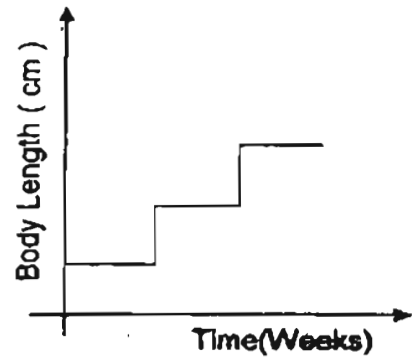

Growth pattern of insect

- (a) Describe one similarity between the growth of the 2 organisms [1]

- (b) An insect nymph F moults 3 times before reaching adult stage. When it moults the third time, it has a body length of 4cm in the 8th week. Complete the graph below to show the growth pattern of F to its adult stage. [2]

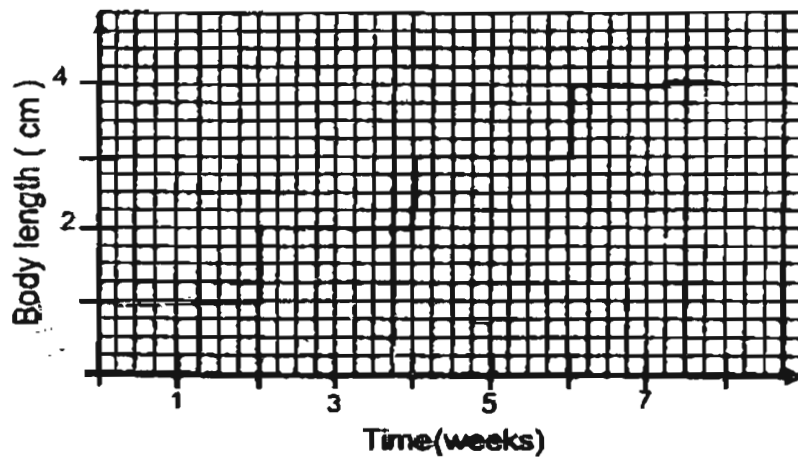

Growth pattern of F

42. The diagram below represents a cross section of a flower R.

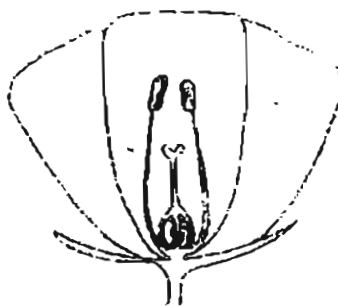

- (a) On the diagram, label the part(s) which produces/produce the pollen grains. [1]
- (b) Looking at the diagram, All concluded correctly that R would not likely undergo wind pollination. Explain why. [1]

43. The muscles of the heart and stomach are important for their functions.

- (a) In the table below, state the functions of the muscles of the two organs. [2]

Organ	Function of muscles of organ
Heart	
Stomach	

- (b) Name a substance which is absorbed by the large intestine. [1]

44. The diagram below shows a germinating seed with parts labelled B, C and D.

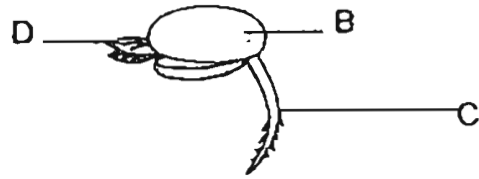

Based on the diagram, for each of the statements below, put a tick (✓) in the appropriate box to indicate if it is true, false or not possible to tell. [2]

	Statements	True	False	Not possible to tell
(i)	B provides food for both C and D.			
(ii)	D grows faster than C when the seed grows into a young plant that makes its own food.			
(iii)	D responds to water by growing towards it.			
(iv)	At the stage as shown above, C does not absorb mineral salts			

45. The transport system of a plant consists of a set of vessels for transporting water and another for transporting food.

- (a) In the table below, put a tick (✓) in the box only when the vessels are present in the organs stated. [1]

Organ	Vessels transporting water	Vessels transporting food
Leaf		
Root		

- (b) The 2 types of vessels do not transport gases. How does gaseous exchange with the surroundings occur in land plants? [1]

46. The diagram below shows the set-up of a test that could be used to find out the amount of energy released when food such as the peanut is burnt.

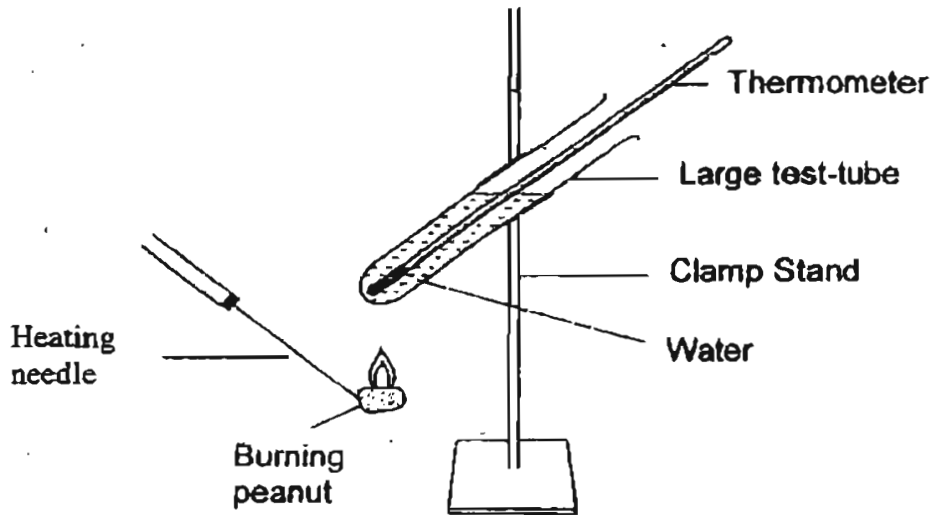

Procedure of test

- The temperature of the water in the large test tube is noted.
- A heating needle is used to hold a peanut in a strong flame until it catches fire.
- The burning peanut is immediately placed beneath the large test tube until the flame goes out.
- The temperature of the heated water is noted.
- The difference in temperature of the water before and after heating is used to calculate the amount of energy released using a formula.

- (a) Complete the energy chain below by filling appropriate word(s) in the boxes to show the conversion or transfer of energy from the sun to the peanut and lastly to the water in the above test.

[1]

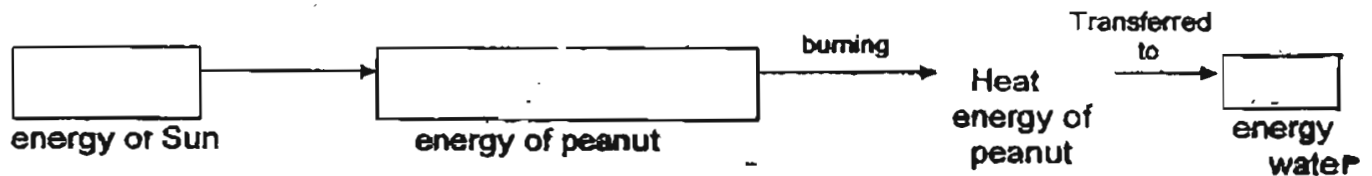

- (b) To ensure a fair test, explain why the amount of water in the large test tube must be kept the same when using the set-up to compare the amount of energy in different types of food?

[1]

- (c) The set-up was used to test 3 types of food E, F and G. The data obtained was shown below.

Food	Temperature of water in °C	
	Before heating	After heating
E	25	32
F	21	40
G	23	33

Using only data shown above, which food E, F or G must be consumed in the largest quantity to obtain as much energy as the others ?

[1]

- (d) Name the process which occurs in our body to release the energy from the peanut when it is consumed.

[1]

End of Paper

Setters: Mrs Lily Lee
Mr Pang K.K.

NANYANG PRIMARY SCHOOL
PRIMARY 6 SCIENCE
PRELIMINARY EXAMINATION 2005

- 1) 2
- 2) 3
- 3) 2
- 4) 4
- 5) 4
- 6) 4
 - b) i) Liquids and solids have a fixed value.
 - ii) Oil is lighter than water.
- 7) 4
- 8) 4
 - 32) a) i) \uparrow ii) \downarrow
- 9) 3
 - b) The effort moves a greater distance than the load.
- 10) 2
- 11) 3
 - 33) a) Amount of soil.
 - b) i) D
 - ii)
 - iii) The root must be long in order to reach the water deep in the ground.
- 12) 2
- 13) 4
- 14) 2
- 15) 4
 - 34) a) More batteries, more electricity.
 - b) Ali's torchlight bulb could be a lower voltage compared to Siti's so there is more electricity flowing in her torchlight.
- 16) 1
- 17) 1
- 18) 1
 - 35) a) Gravitational force.
 - b) i) The rubber ball would bounce higher.
 - ii) The rubber ball is elastic so less gravitational potential energy was changed to sound and heat energy so the ball has more kinetic energy to bounce higher.
- 19) 4
- 20) 3
- 21) 2
- 22) 2
- 23) 2
 - 36) a) There were less coils around Rod R compared to Rod A. Hence, the magnetism was weaker in R.
 - b) Rod A is magnetic but Rod T is not magnetic.
- 24) 3
- 25) 2
- 26) 3
 - 37) a) once alive b) metals c) wool d) copper
- 27) 2

38) a) Move the weight P away from the fulcrum.

b) Add more water.

39) Greenhouse gases in the atmosphere trap heat from the sun. Trapped heat warms the earth.

40) a) Their parents protect them and feed them.

b) The young plant would then need not compete for sunlight nutrients and water with the parent plant.

41) a) For both organisms the body length increases with weeks.

b)

42) a)

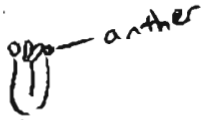

b) As the reproductive parts is inside the flower, it is not likely to be pollinated by wind.

43) a) To pump blood to the rest of the body.

To churn and grind the food into a watery substance.

b) Water

44)

✓		
		✓
	✓	
		✓

45) a)

✓	✓
✓	

b) The plant uses the stomata in the leaves

46) light chemical potential heat

b) For the same amount of heat released, temperature of water is higher if volume of water is less.

c)E

d) respiration