



MAHA BODHI SCHOOL
2010 PRELIMINARY EXAMINATION
PRIMARY SIX (STANDARD) SCIENCE

Name : _____ ()

Date : 26 August 2010

Class : Primary 6 ()

Duration: 1 hour 45 minutes (Booklets A and B)

Booklet A : [30x 2 marks = 60 marks]

For each question from 1 to 30, four-options are given. One of them is the correct answer. Make your choice (1, 2, 3 or 4).

Shade your answer on the Optical Answer Sheet.

1. Which one of the following characteristics for the organisms in the table below is not correct?

	Organism	Characteristic
(1)	Plants	Can make food
(2)	Fungi	Feed on living and non- living things
(3)	Animals	Can move from one place to another
(4)	Bacteria	Made up of many cells

2. Which one of the following statement(s) is/are true of a cockroach and a butterfly?

- A. Their young do not have wings.
- B. Their young look like the adults.
- C. They have 4 stages in their life cycle.

- (1) A only
- (2) C only
- (3) A and B only
- (4) B and C only

3. The diagram below shows the cross-section of a flower.

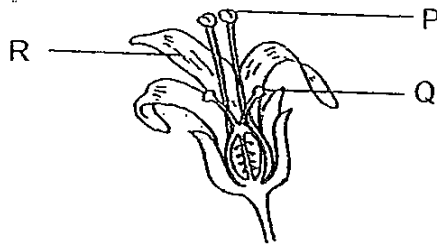

This flower will develop into a fruit after fertilisation.





Which of the following statements about the flower is/are correct?

- A. It has two anthers.
- B. Its fruit will have more than one seed.
- C. Its pollen grains are transferred from P to Q.
- D. After fertilisation, only R will wilt and drop off.

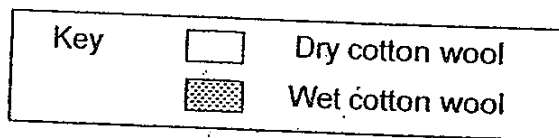
- (1) A only
- (2) A and B only
- (3) B and C only
- (4) C and D only

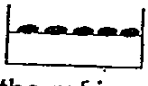
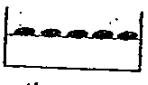
4. Which one of the following set-ups should be used to find out if seeds need warmth to germinate?

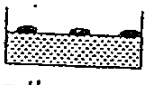
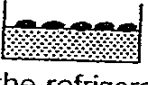

- | | | |
|-----|--|--|
| (1) | 
In the room | 
In the refrigerator |
| (2) | 
In the room | 
In the refrigerator |
| (3) | 
In the room | 
In the refrigerator |
| (4) | 
In the room | 
In the refrigerator |

5. The diagrams below show the fruits of three different plants, A, B and C.



Fruit of Plant A
Has wing-like structure



Fruit of Plant B
Splits open when ripe



Fruit of Plant C
Fleshy and juicy when ripe

The maps below show the dispersal pattern of the seeds of the plants.

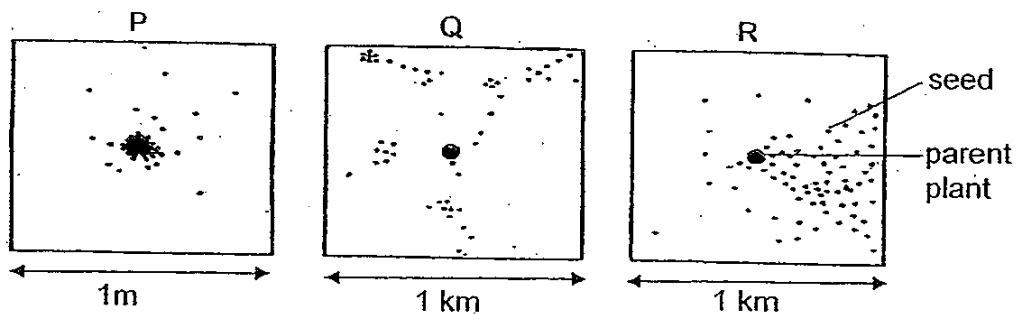

Which one of the following shows the dispersal pattern of seeds for fruits of plants A, B and C?

	Seeds of		
	Plant A	Plant B	Plant C
(1)	R	P	Q
(2)	Q	P	R
(3)	R	Q	P
(4)	P	Q	R

6. Which of the following functions are carried out by both plants and animals?

- A. Response to external factors
 - B. Taking in food from the surroundings
 - C. Transport of materials within the organism
- (1) A only
 (2) B only
 (3) A and C only
 (4) B and C only

7. The diagram below shows the flow of blood in the body.

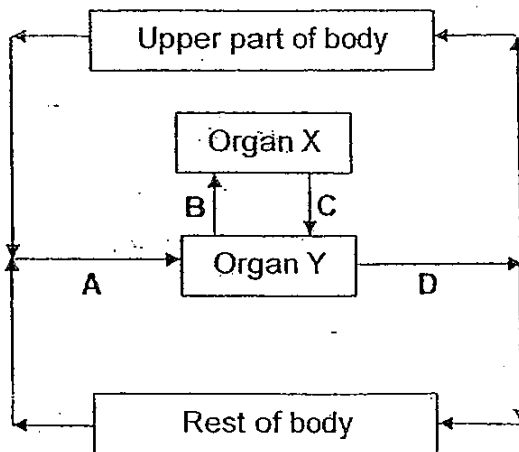

A, B, C and D represent blood vessels.

What are the characteristics of blood in blood vessels A, B, C and D?

	Organ X	Organ Y	Blood rich in _____			
			A	B	C	D
(1)	Heart	Lungs	carbon dioxide	carbon dioxide	oxygen	oxygen
(2)	Heart	Lungs	oxygen	oxygen	carbon dioxide	carbon dioxide
(3)	Lungs	Heart	oxygen	carbon dioxide	carbon dioxide	oxygen
(4)	Lungs	Heart	carbon dioxide	carbon dioxide	oxygen	oxygen

8. The following food relationship was observed among four organisms, P, Q, R and S in a habitat.

P feeds on R.
 Q is eaten by R.
 S feeds on R.
 Q is eaten by P.

Which one of the following shows how the organisms can be classified?

	Producer	Herbivore	Omnivore	Carnivore
(1)	R	S	Q	P
(2)	Q	R	P	S
(3)	P	Q	R	S
(4)	Q	P	S	R

9. Joy smeared different surfaces of two identical leaves with Vaseline and hung them in an airy place. She weighed the leaves every day.

Vaseline gives a waterproof covering to the surface.

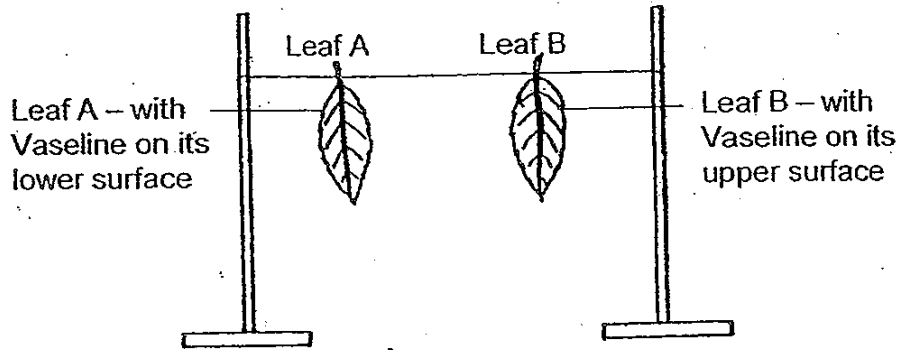

Which one of the following graphs shows the change in weight of the leaves?

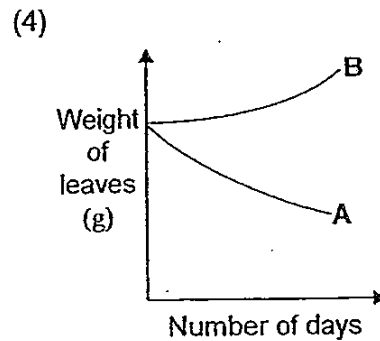
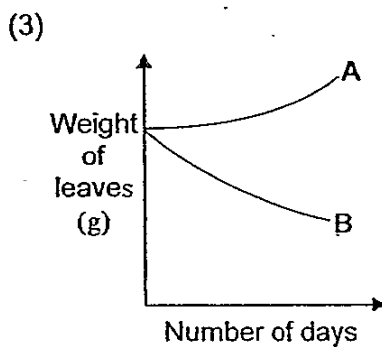
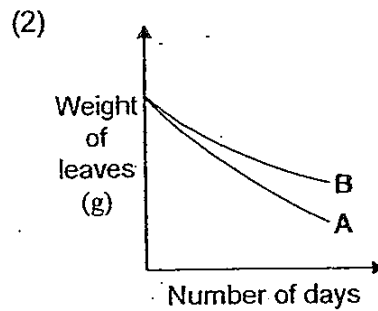
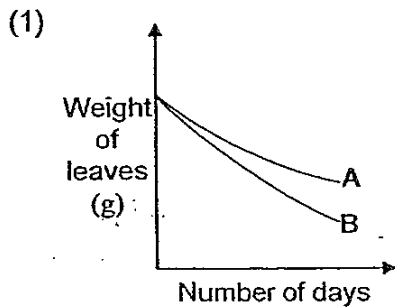

10. Organisms A, B, C, D and E are found in a field community. The table below shows the food for some of the organisms.

Consumer	Feed on
A	B, C
B	C, E
D	B, E
E	A

Which one of the following shows the food relationship in the community?

(1)

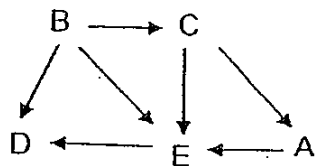

(2)

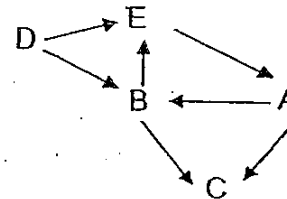

(3)

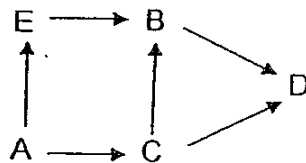

(4)

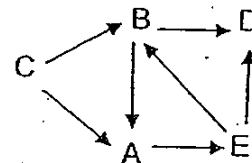

11. Study the food web below.

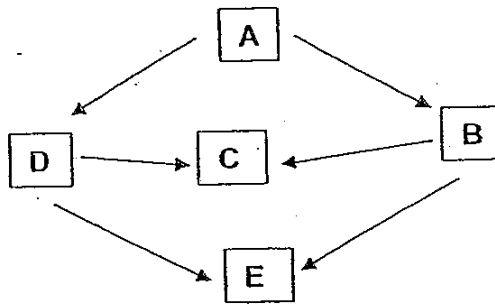

If the entire population of D were completely removed from the food web, which one of the following graphs shows what would happen to the populations A, B and C?

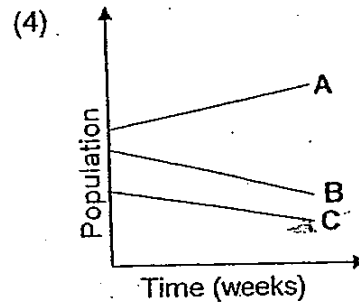
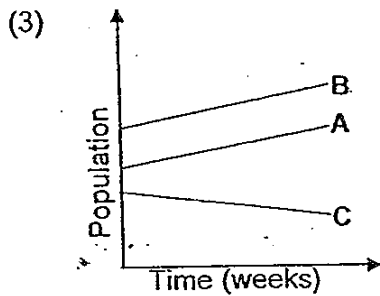
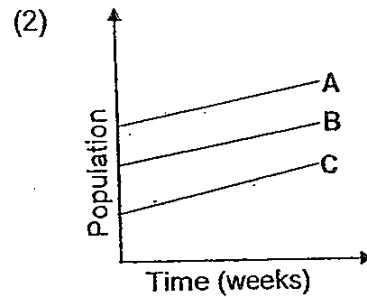
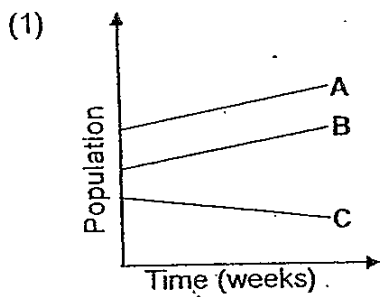

12. Which one of the following classification is correct?

(1)

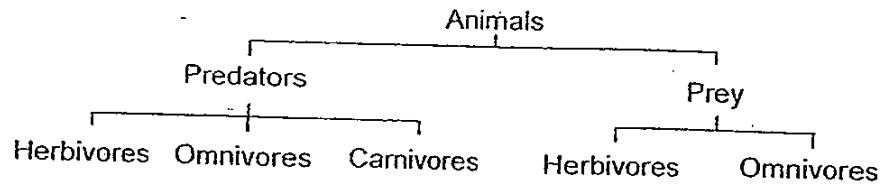

(2)

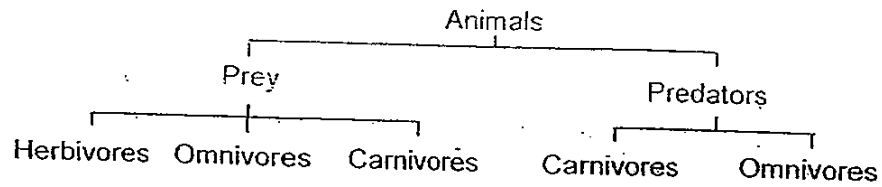

(3)

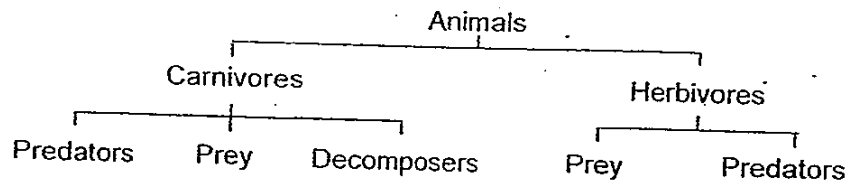

(4)

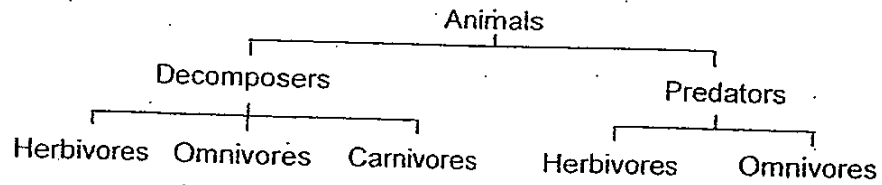

13. Which one of the following statement(s) is/are correct?

- A. Fertilisers are food for plants.
- B. Only living things have energy.
- C. Energy transfer decreases along a food chain.
- D. Living things do not need energy when they are at rest.

- (1) B only
- (2) C only
- (3) A and C only
- (4) B and D only

14. Two similar potted plants are put into sealed glass cases as shown in the diagram below. The plants are watered at the beginning of the experiment:

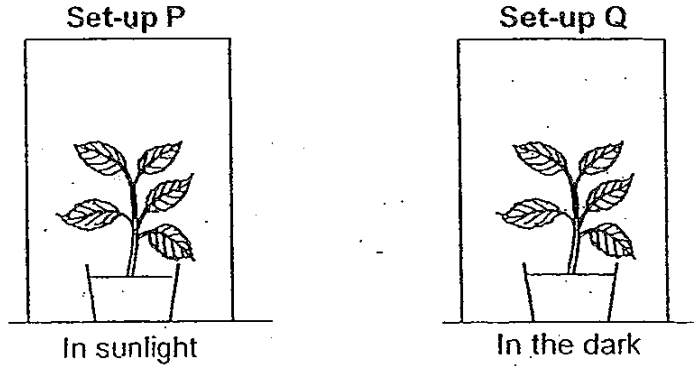

The graphs below show the change in the amount of oxygen and carbon dioxide over a period of time.

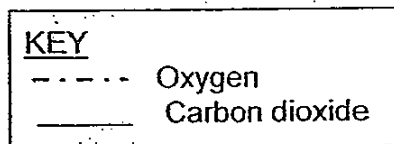
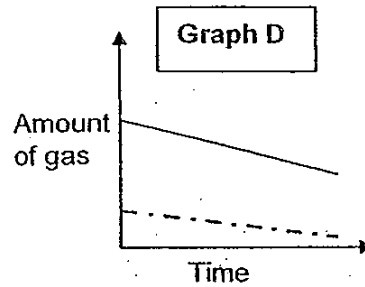
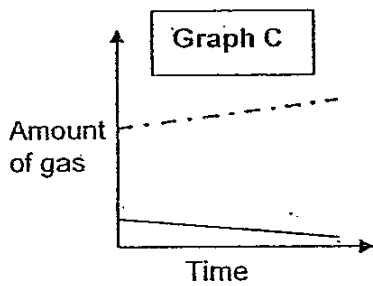
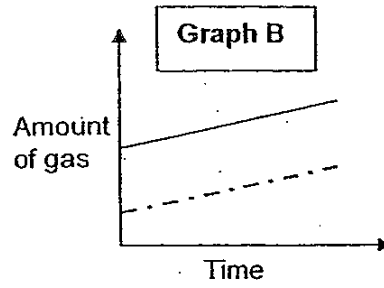
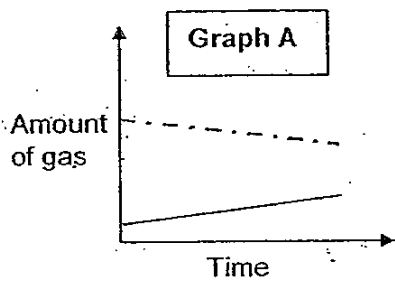

Which of the graphs above represent the change in the amount of oxygen and carbon dioxide in each set-up during the experiment?

	Set-up P	Set-up Q
(1)	A	C
(2)	B	D
(3)	C	A
(4)	D	B

15. Zenn sets up the following experiment to investigate the gases involved during the germination of seeds.

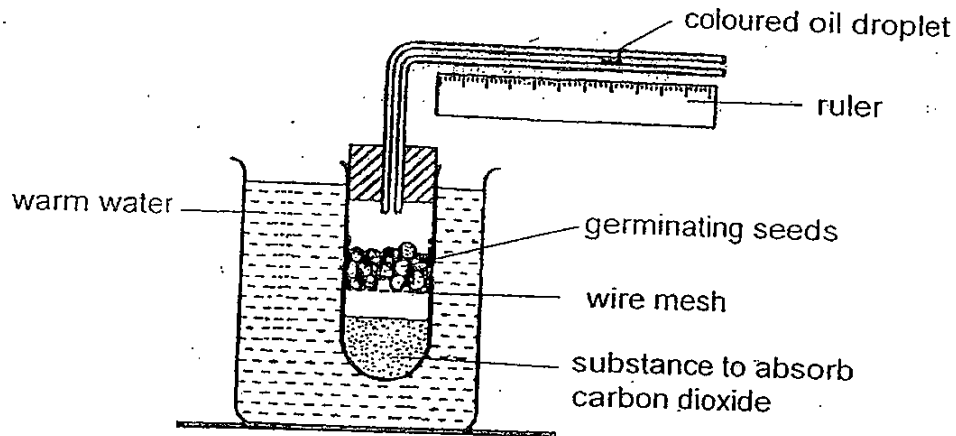

What can Zenn measure using this set-up?

- (1) Amount of oxygen used up
- (2) Amount of oxygen released
- (3) Amount of carbon dioxide used up
- (4) Amount of carbon dioxide released

16. The six materials listed below can be classified into two groups with three materials in each group.

Iron	Ceramic	Water	Copper	Wood	Glass
------	---------	-------	--------	------	-------

Which one of the following are headings for Group A and B?

	Group A	Group B
(1)	Metals	Non-metals
(2)	Magnetic	Non-magnetic
(3)	Conducts electricity	Does not conduct electricity
(4)	Allow light to pass through	Does not allow light to pass through

17. Joy wanted to investigate the ability of two objects to float or sink in liquids A, B and C. The two objects are made of different materials.

The diagram below shows the results of her experiment.

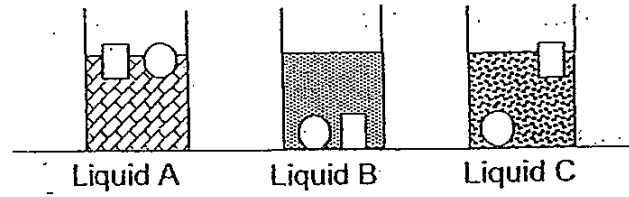

If Joy puts both objects in a cylinder containing all three liquids, which one of the following will show the position of the objects?

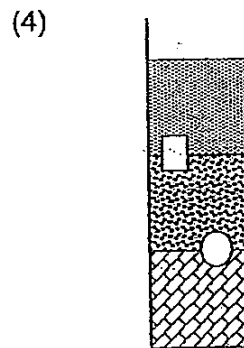
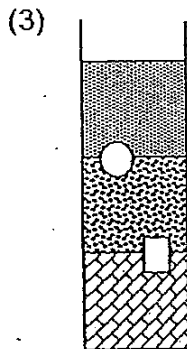
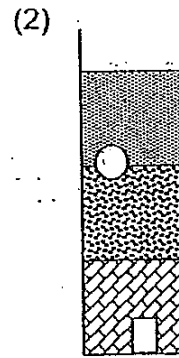
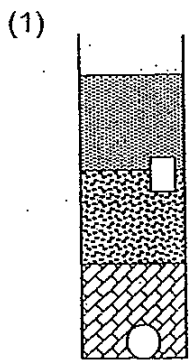

18. Zenn put a dish of water in a container. He sealed the container so that nothing could get in or out of the container. The total mass of the container and its contents is 500g.

12 hours later, some of the water in the dish has evaporated. Again he weighed the container and its contents.

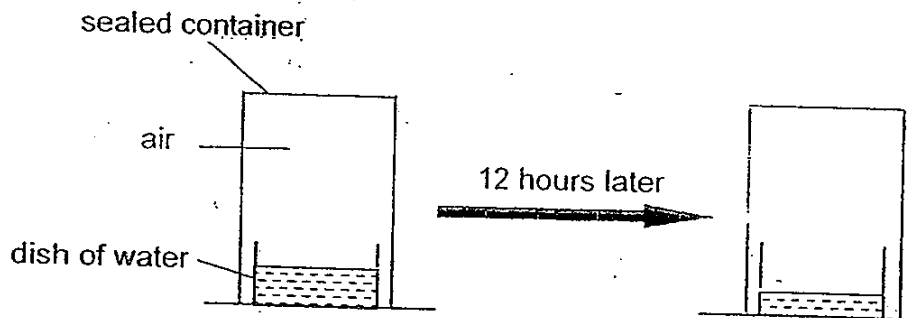

According to the results of Zenn's experiment, which one of the following shows the mass of the container and its contents 12 hours later?

- (1) 200g
 - (2) 300g
 - (3) 500g
 - (4) 600g
19. Which of the following statement(s) about the water cycle is/are correct?
- A. Warm air cools as it rises.
 - B. Clouds are made up of water vapour.
 - C. Evaporation takes place at 100°C only.
 - D. The water cycle follows a repeated pattern.
- (1) A only
 - (2) B only
 - (3) A and D only
 - (4) A, B, C and D

20. Joy placed a container of cold water and ice cubes in a glass box as shown in the diagram below.

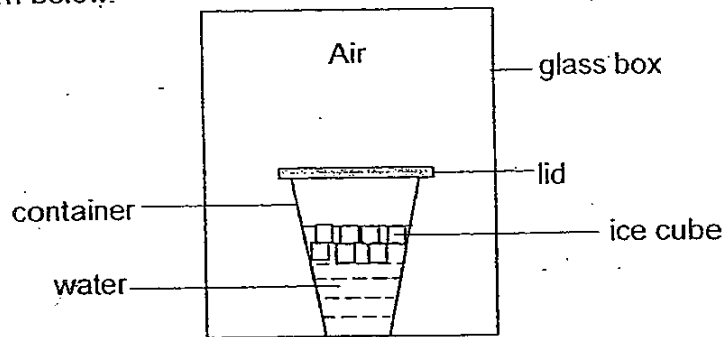

What will happen to the air in the glass box after 20 minutes?

	Temperature	Amount of water vapour
(1)	Decrease	Decrease
(2)	Increase	Increase
(3)	Increase	Decrease
(4)	Decrease	Increase

21. The diagram below shows four circuits with different arrangements of identical batteries and identical bulbs. The bulbs in all the circuits lit up.

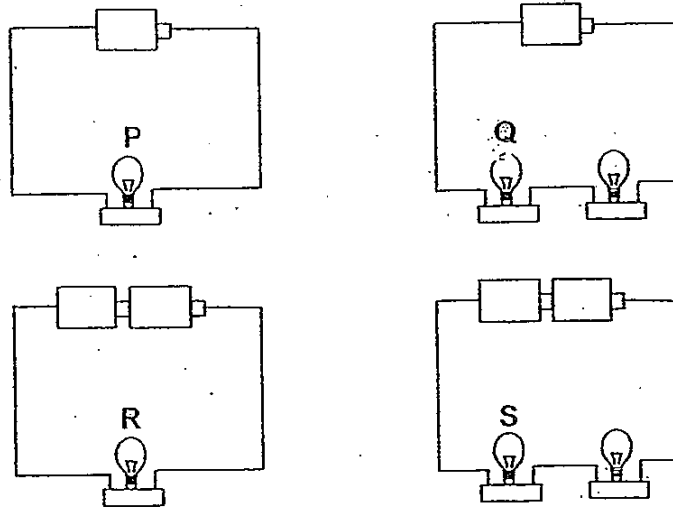

Which one of the following shows the brightness of the bulbs P, Q, R and S?

Brightness of bulbs		
Low	Medium	High
(1) Q	P	S
(2) Q	S	R
(3) S	R	Q
(4) S	P	R

22. WX, XY, YZ and ZW are thin wires made of different materials connected at points W, X, Y and Z.

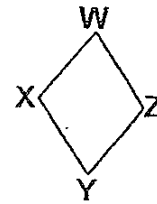
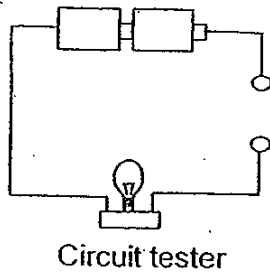

Zenn tested the wires with the circuit tester and recorded his observation in the table below.

Circuit tester connected to	Did bulb light up? Yes/No
XZ	Yes
ZY	No

Based on the results of Zenn's experiment, which of the following statements is/are definitely true?

- A. Wire WX is a conductor of electricity.
 - B. Wire XY is a conductor of electricity
 - C. Wire ZY is not a conductor of electricity.
 - D. Wire WZ is not a conductor of electricity.
- (1) A only
- (2) B and C only
- (3) C and D only
- (4) A and C only

23. Joy set up the circuit as shown below. The switch was closed for 8 minutes and then left open.

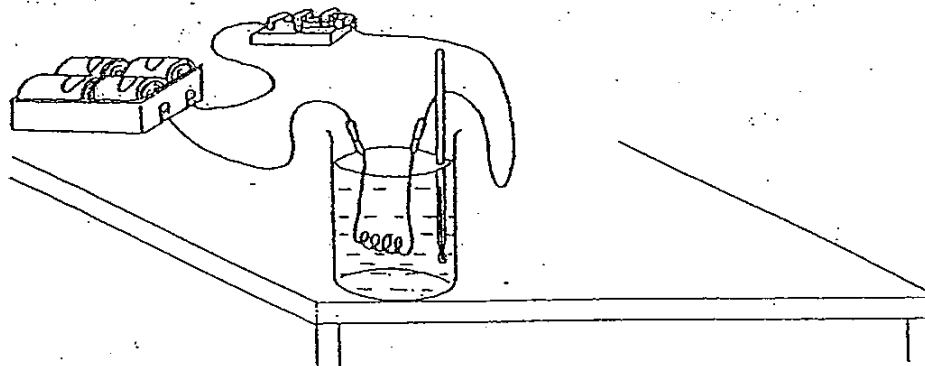

Which one of the following graphs shows the change in temperature of the water with time?

(1)

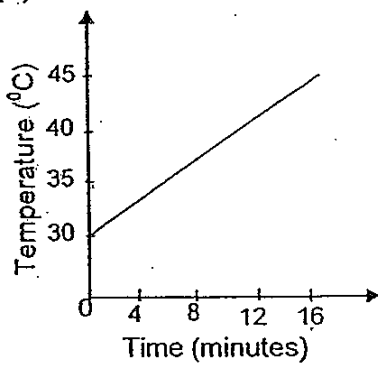

(2)

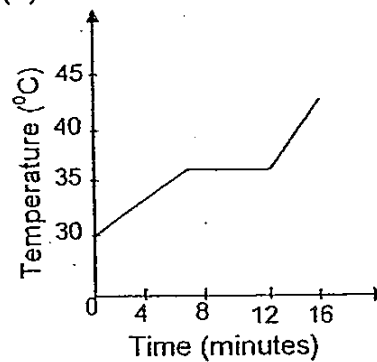

(3)

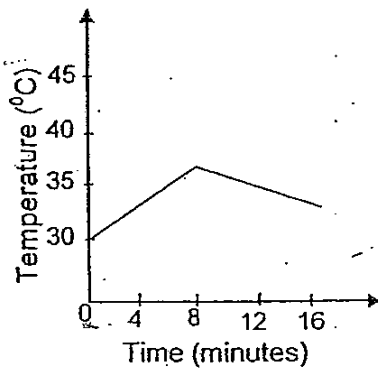

(4)

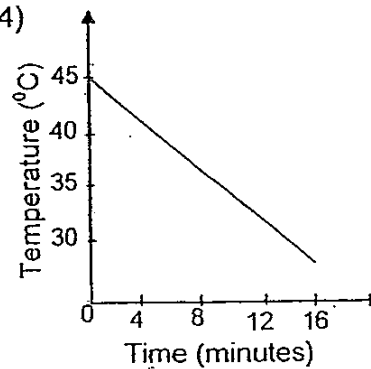

24. Zenn suspended a magnet on a retort stand as shown in the diagram below.

He brought one end (marked X) of Object A towards the S-pole of the magnet, and then brought the other end (marked Y) towards the same pole of the magnet. He recorded his observation in the table below.

He repeated his experiment with two more objects B and C, which also have their ends marked X and Y.

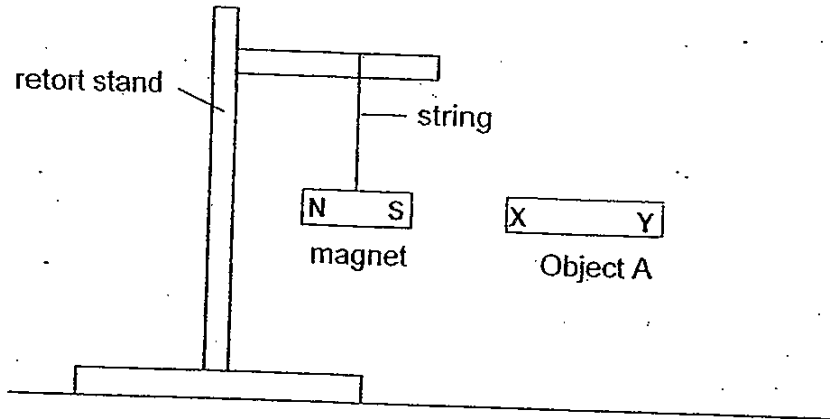

Object	End of object	Is the magnet attracted to the object or repelled by it?
A	X	Attracted
	Y	Attracted
B	X	Remained stationary
	Y	Remained stationary
C	X	Attracted
	Y	Repelled

From the results of Zenn's experiment, what could objects A, B and C be?

	Object A	Object B	Object C
(1)	steel screw	magnet	iron nail
(2)	iron nail	copper strip	magnet
(3)	magnet	iron nail	steel screw
(4)	copper strip	steel screw	magnet

25. Which of the following statements is/are false?

- A. There is no friction between two smooth surfaces.
- B. There are forces acting on a stationary car on a slope.
- C. Gravitational force acts only on objects placed above the ground.

- (1) A only
- (2) B only
- (3) A and C only
- (4) A, B and C

26. Zenn conducted the following experiment.

He took two identical pieces of paper. He crumpled one into a ball. He stood on the chair and dropped both pieces of paper from the same height at the same time. He observed which piece of paper landed on the floor first.

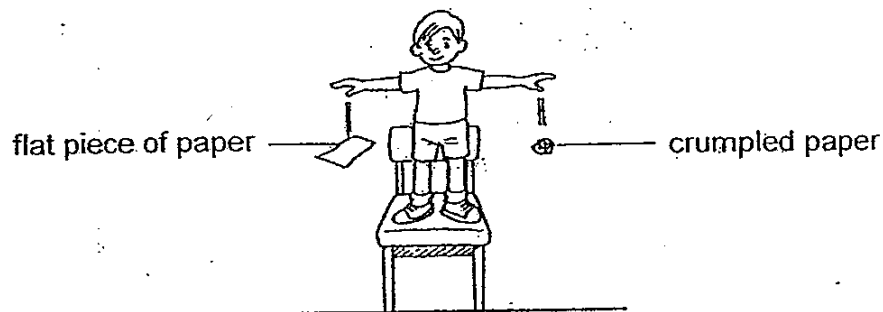

Which one of the following shows his observation and the explanation for his experiment?

	Observation	Explanation
(1)	The flat piece of paper landed first.	There was more gravitational force acting on it.
(2)	The flat piece of paper landed first.	It experienced less air resistance.
(3)	The crumpled paper landed first.	There was more gravitational force acting on it.
(4)	The crumpled paper landed first.	It experienced less air resistance.

27. Joy wanted to find out how quickly water and sand heat up and cool down. She filled two similar containers, one with water and the other with sand. She used a light bulb as the source of heat.

The light bulb was switched on for 9 minutes and then switched off.

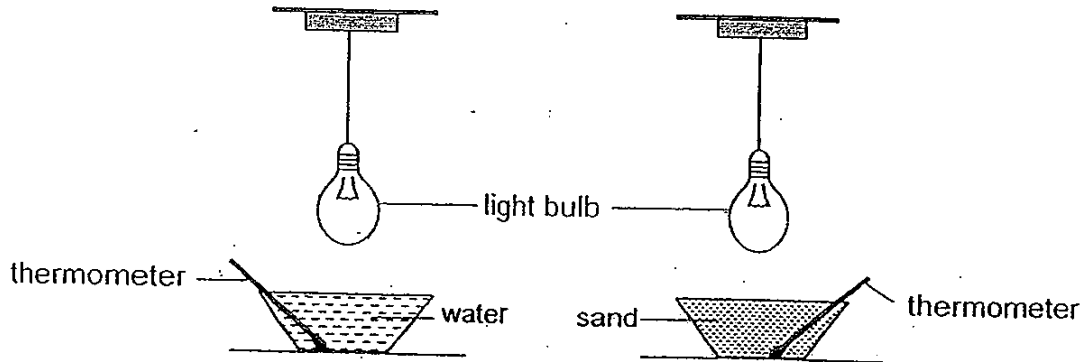

She recorded her results in the table below.

Time (minutes)	Temperature ($^{\circ}\text{C}$)	
	Water	Sand
0	20	20
3	22	24
6	24	28
9	26	32
12	25	29
15	24	26

Based on the results of Joy's experiment, we can conclude that water heats up A and cools down B than sand.

What can A and B be?

	A	B
(1)	more quickly	more quickly
(2)	more quickly	more slowly
(3)	more slowly	more slowly
(4)	more slowly	more quickly

28. Zenn put a thermometer in three set-ups A, B and C placed on the same table as shown in the diagram below.

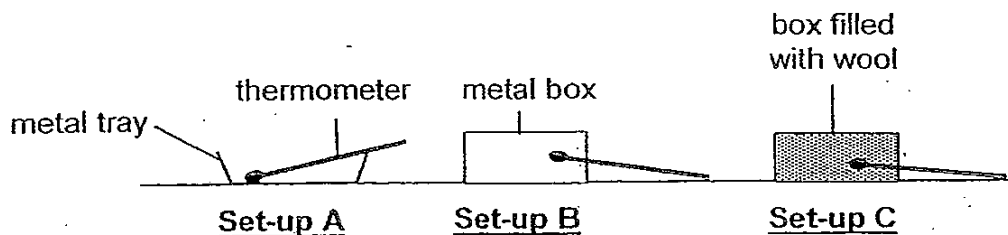

He recorded the temperature of the three set-ups at the start of the experiment. The temperature in the room was 30°C .

Set-up	Temperature at the start of experiment ($^{\circ}\text{C}$)
A	30
B	30
C	30

The temperature in the room remained the same during the experiment. An hour later, Zenn again recorded the readings on the three thermometers.

Which one of the following shows the temperature on the three thermometers?

	Set-up A	Set-up B	Set-up C
(1)	30	33	33
(2)	30	27	33
(3)	30	33	27
(4)	30	30	30

29. Joy is holding a red book in her hand. She is standing in a room that has only one door and no windows.

Her friend switches off the only light in the room and closes the door. The room is in total darkness.

Which of the following statements is true after Joy's eyes have adjusted to the darkness?

- (1) Joy cannot see the book.
- (2) Joy can see the red book.
- (3) Joy can see a faint red outline of the book.
- (4) Joy can see the book but not the red colour.

30. Zenn walks from point A to point C. He passes a lamp post at point B. The lamp at point B is the only light source nearby.

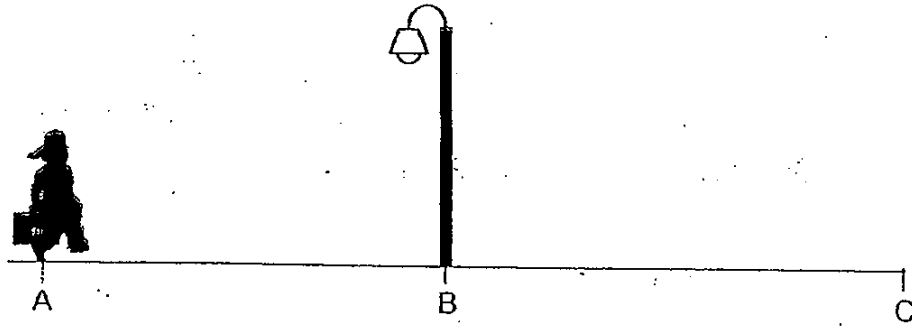

Which one of the following graphs below shows how the length of Zenn's shadow changes from point A to point C?

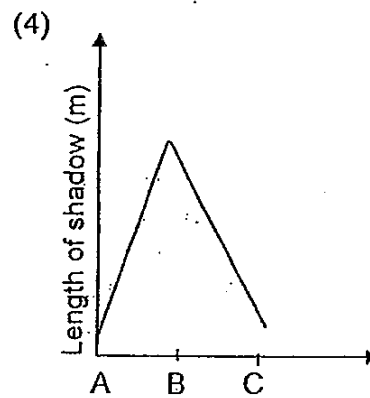
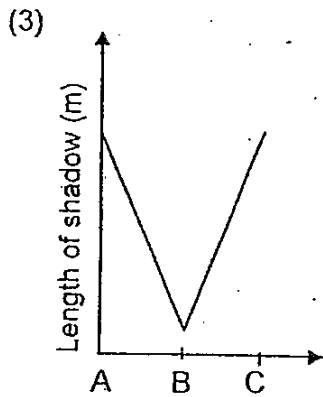
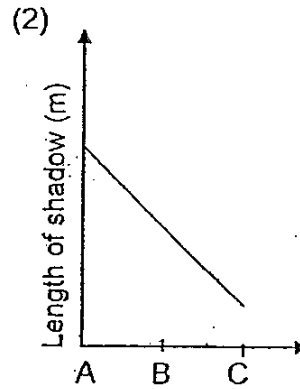
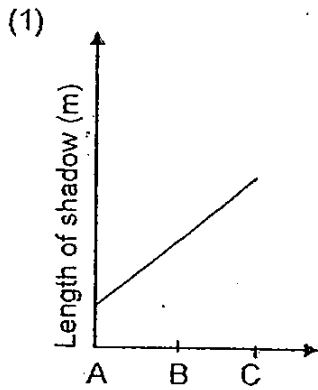

END OF BOOKLET A

GO ON TO BOOKLET B



MAHA BODHI SCHOOL
2010 PRELIMINARY EXAMINATION
PRIMARY SIX (STANDARD) SCIENCE

Name : _____ ()

Class : Primary 6 _____)

Duration : 1 h 45 min (Booklets A and B)

Date : 26 August 2010

Parent's Signature: _____

Booklet A (60 marks)	
Booklet B (40 marks)	
Total (100 marks)	

Booklet B: (40 marks)

For questions 31 to 44, write your answers in this booklet.

The marks available are shown in brackets [] at the end of each question.

31. Study the classification of the organisms given below.

Group A	Group B	Group C
Cat	Chicken	Balsam plant
Whale	Butterfly	Papaya tree

(a) How are the organisms classified? [1]

(b) Based on the classification above, can Bird's Nest Fern be classified under Group C? Explain your answer. [½]

(c) How does the Bird's Nest Fern obtain its food? [½]

Marks : 12

32. Zenn set up 3 similar sealed jars, A, B and C as shown in the table below.

Five days later, he lowered a lighted candle into Jar A and recorded the time the candle burned before going out. He repeated the same procedure for Jar B and Jar C, using similar candles.

He recorded the result of his experiment in the table below.

Jar	Condition in jar	Burning time of candle (seconds)
A	5 seeds on moist cotton wool	12
B	5 seeds on dry cotton wool	24
C	Empty	30

(a) From the result of Zenn's experiment, are the dry seeds living things? Explain your answer. [1]

(b) (i) Identify the life process that is happening to the seeds in Jar A but not in jar B? [½]

(ii) Where do the seeds get its energy for this life process? [½]

(c) Some animals behave in a similar way as the seeds in Jar B during winter. State two ways this behaviour helps the animals survive the winter. [1]

(i)

(ii)

33. The diagram below shows how our organ systems work together to ensure that our body functions properly.

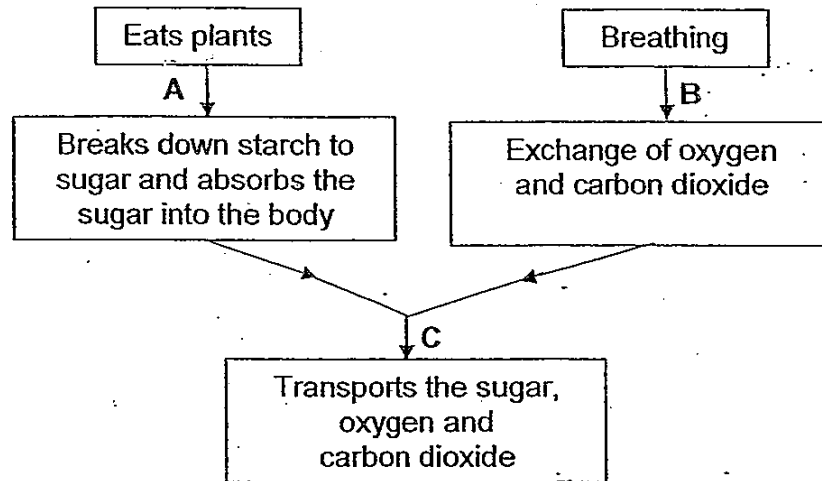

- (a) Identify the organ systems involved at each stage. The first one, A, has been done for you. [1]

	Organ system
A	Digestive system
B	
C	

- (b) How does chewing help in the digestion of food? [1]

- (c) Where does the exchange of oxygen and carbon dioxide take place in organ system B? [1]

34. Zenn shone a torch light through some water from pond A. He recorded the amount of light collected on a piece of white paper at the base of the tripod stand.

The diagram below shows the set-up for his experiment.

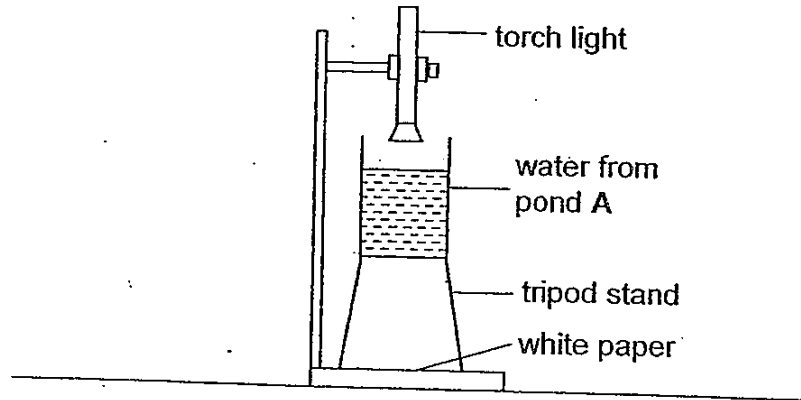

Zenn repeated his experiment with the same amount of water from ponds B, C and D using similar set-ups.

He recorded the results of his experiment in the table below.

Water from pond	Amount of light on the white paper
Pond A	Very bright
Pond B	Dim
Pond C	Bright
Pond D	Very dim

- (a) From the results of Zenn's experiment, in which pond would submerged aquatic plants have difficulty growing? Explain your answer.

[1]

- (b) State another factor that could affect how much light could reach into the pond water on a clear sunny day.

[1]

34. (c) State and explain two structural adaptations of aquatic plants that enable them to survive in the pond named in (a). [1]

(i)

(ii)

Marks : 1/1

35. Joy identified the parts of cells A, B and C under the microscope. She recorded her observation in the table below.

	Type of cells		
	Cell A	Cell B	Cell C
Nucleus	✓	✓	✓
Cell wall	✓	✓	X
Cell membrane	✓	✓	✓
Cytoplasm	✓	✓	✓
Chloroplast	X	✓	X

KEY

✓ - present in cell
X - absent in cell

- (a) Based on what Joy observed, which of the cells is/are plant cells? Explain your answer.

[1]

- (b) On which part of the plant can the cell(s) in (a) be found?

[1]

- (c) Using the information given in the table above, draw and label Cell C. [1]

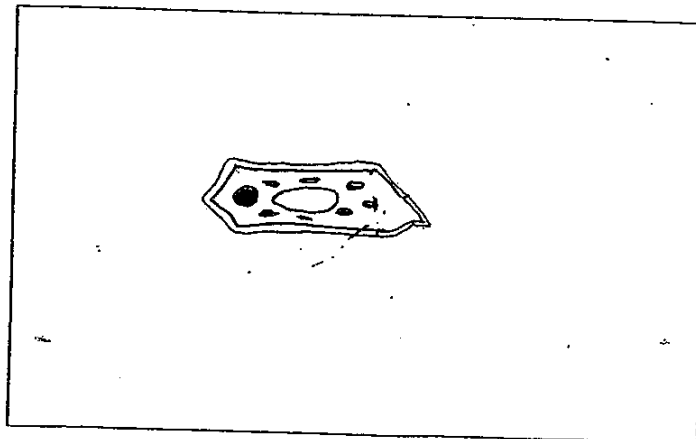

36. Most organisms have adaptations that enable them to live in their natural habitats.

(a) Explain how the following adaptations help the organisms survive in their natural habitat. [1]

Organism	Adaptation	Function
Polar bear.	Stiff hair on the soles	
Zebras	Live in large groups	

(b) Adaptations for survival in an organism's natural habitat are usually not suitable for survival in another habitat.

Why is this so? [1]

(c) Predators do not need camouflage.

Is this statement true or false? Explain your answer. [1]

Marks: / 3

37. Joy set up three similar containers, X, Y and Z as shown below. All three containers contain carbon dioxide indicator. The containers were left under sunlight for 12 hours.

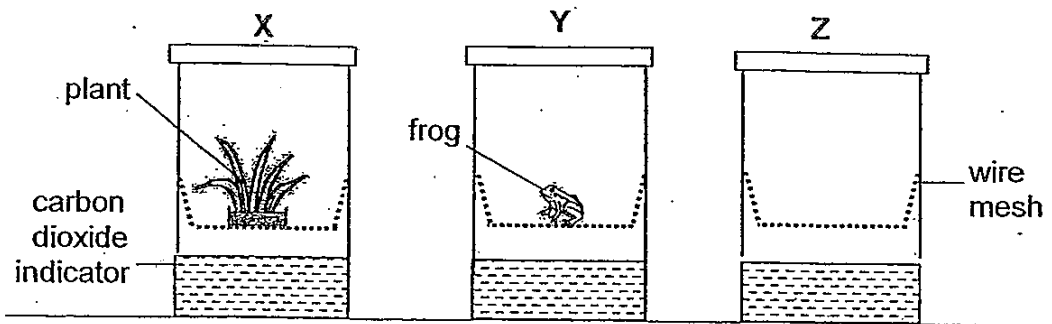

The colour of the carbon dioxide indicator will change according to the amount of carbon dioxide present as shown below.

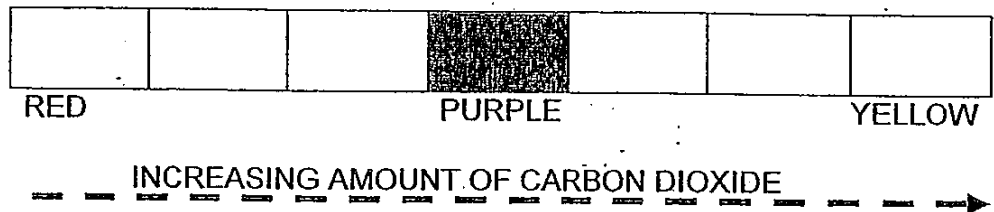

At the beginning of the experiment, the carbon dioxide indicator in each container was purple in colour.

- (a) Mark in the scale below the colour of the carbon dioxide indicator for containers X and Y twelve hours later.

The colour for container Z has been done for you.

[1]

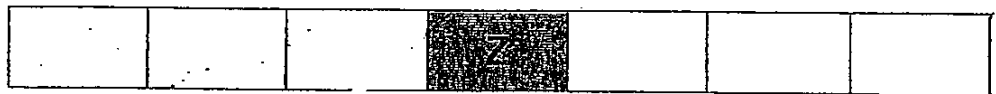

- (b) Explain the colour change for container X.

[1]

- (c) Why was it necessary to set up container Z?

[1]

38. Zenn put hot water in set-up A and cold water in set-up B.

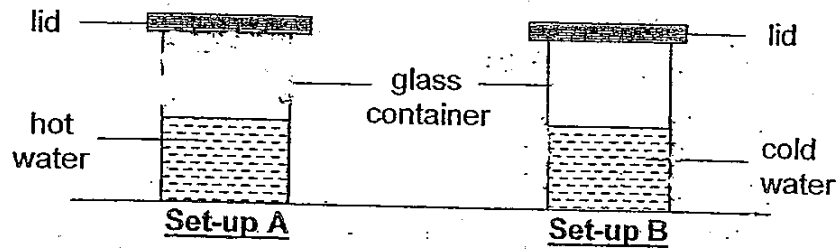

He observed that water droplets are formed in both set-ups after a few minutes.

(a) Show where the water droplets are formed by drawing in the diagrams above. [1]

(b) Where do the water droplets for each set-up come from? [1]

(i) Set-up A:

(ii) Set-up B:

(c) Explain how the water droplets are formed in set-up A. [1]

Marks /3

39. Joy wanted to find out the effect of size of ice cubes in lowering the temperature of water.

She used large ice-cubes in set-up A and small ice-cubes in set-up B. The total mass of the ice-cubes in each set-up is the same. She used similar containers with equal amount of water at the same temperature for both set-ups.

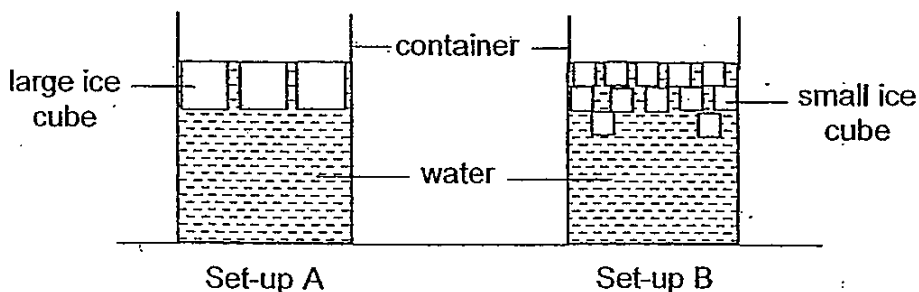

She recorded the time for the temperature of water to reach 20°C, 15°C and 10°C in the table below.

Temperature of water (°C)	Time to reach temperature (minutes)	
	Set-up A	Set-up B
20	1.0	0.5
15	2.0	1.0
10	3.0	1.5

- (a) Explain how ice cubes could lower the temperature of the water? [1]

- (b) Based on the results of Joy's experiment, in which set-up, A or B, is the temperature of water lowered more quickly? Why is this so? [2]

Marks	<u>13</u>
-------	-----------

40. The diagram below shows the electrical circuit for bulbs in a house.

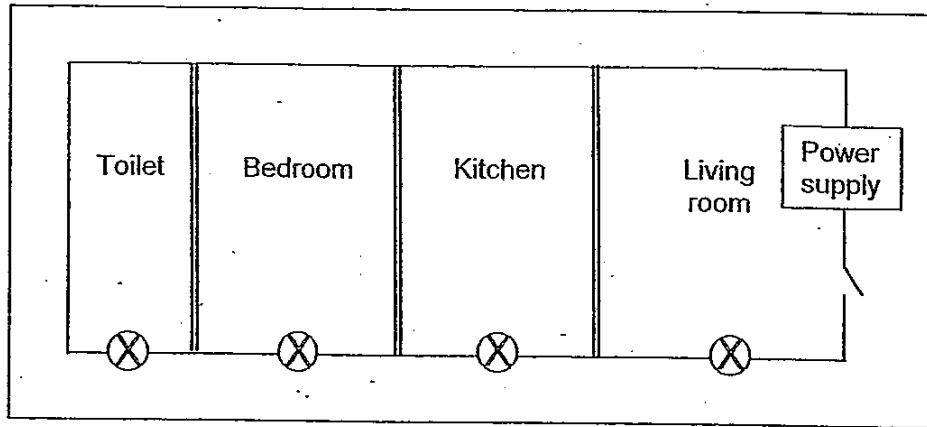

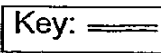
Key:  wall

(a) Give two reasons why this is not the best way to connect the bulbs. [1]

(b) In the diagram below, show how the connection of bulbs can be improved to solve the problems mentioned in (a).

Use only electrical circuit symbols, 4 bulbs and the given power supply. You may use more than one switch. [2]

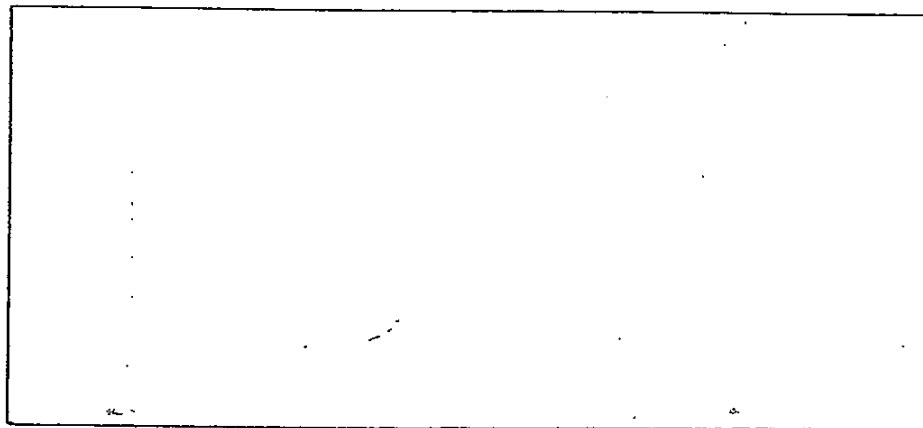

Marks : / 3

41. Zenn fixed a bar magnet on a table.

He moved two ring magnets towards the bar magnet. Ring magnet A was attracted to the bar magnet. Ring magnet B was repelled by the bar magnet.

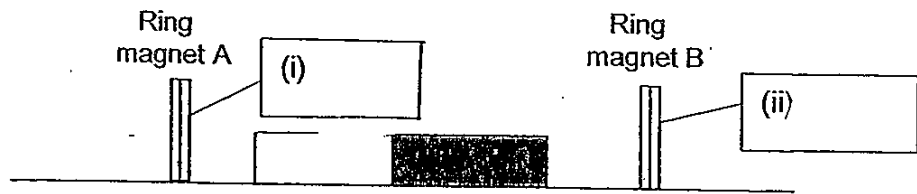

(a) State the poles of the ring magnets, A and B, in the boxes (i) and (ii) provided in the diagram above. [1]

(b) Using only a ruler, a bar magnet and a paper clip, describe how you can determine whether the N-pole or the S-pole of the bar magnet is stronger. List the steps for the investigation below. [2]

Step 1	

Marks : / 3

42. Zenn built a very tall tower on the Earth.

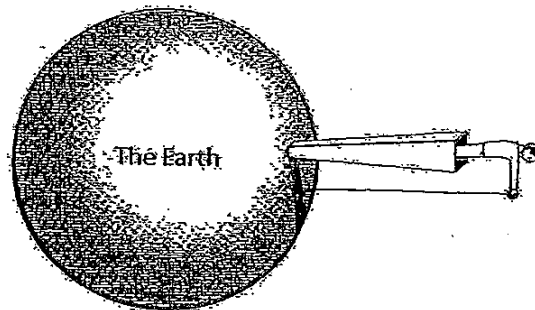

(a) Zenn stands at the top of the tower and drops a ball.
On the diagram above, draw a line with an arrow (from the hand holding the ball) to show the path the ball will travel when it is dropped from the tower. [1]

(b) Explain why the ball drops the way your arrow shows in (b). [1]

(c) State the energy conversion involved when the ball is released. [1]

Marks : 3

43. Joy placed a test-tube of hot water in a beaker of cold water.

She measured the temperature of the water in the beaker and in the test tube at the start of the experiment.

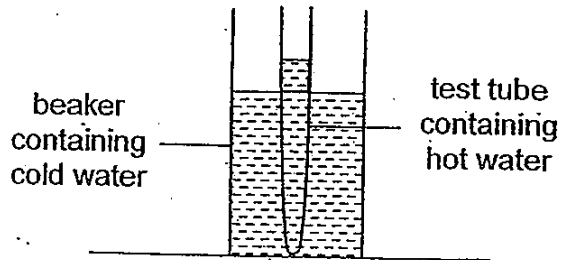

(a) What would happen to the temperature of the water in the beaker after 20 minutes? Explain your answer. [1]

(b) A refrigerator uses electrical energy to maintain the temperature inside at 4 °C.

Joy's teacher advised her to allow hot food to cool before placing it in the refrigerator as this will help to save electricity.

Explain how cooling down the food first help to save electricity. [1]

Marks : / 2

44. Zenn used a similar cardboard material to fold different beams of the same mass and length.

He wanted to find out which beam is the strongest.

He suspended each beam between two desks to form a bridge and added weights to a scale pan until the beam just collapsed. He fixed the distance between the two desks and used the same scale pan and length of string for each beam.

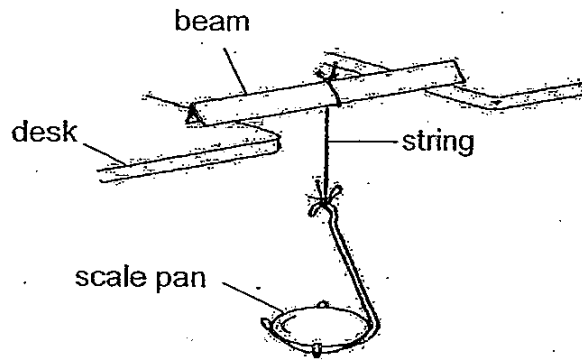
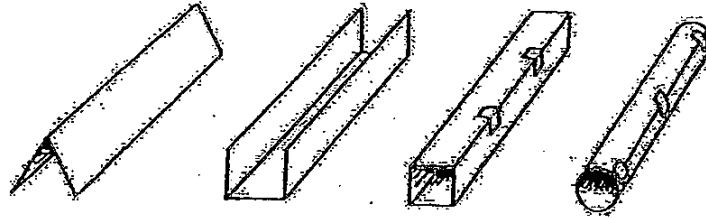

- (a) State 2 other variables that Zenn must keep the same to have a fair test. [1]

(i) _____

(ii) _____

- (b) What must he measure to determine which beam is the strongest? [1]

- (c) Zenn's teacher advised him to increase the weights by small amounts in this experiment.

Explain why it is important to do so.

[1]

Marks : / 1

- END OF PAPER -

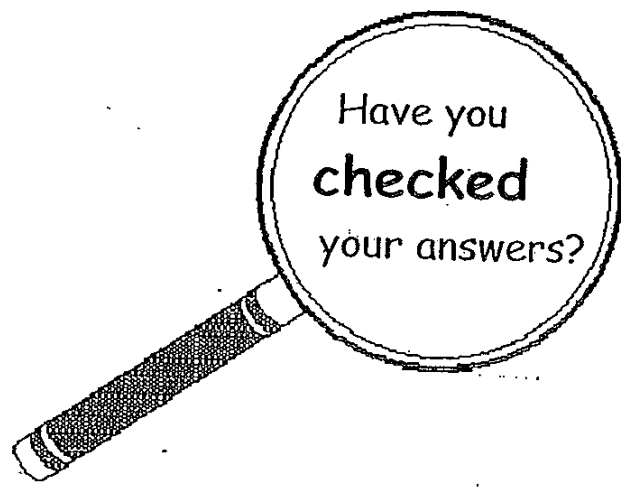

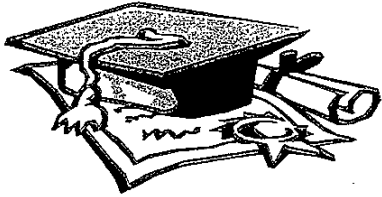

ANSWER SHEET

EXAM PAPER 2010

**SCHOOL : MAHA BODHI PRIMARY
SUBJECT : PRIMARY 6 SCIENCE**

TERM : PERLIMINARY

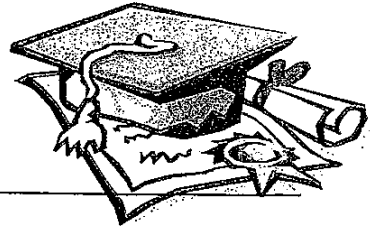

Q1	Q2	Q3	Q4	Q5	Q6	Q7	Q8	Q9	Q10	Q11	Q12	Q13	Q14	Q15	Q16	Q17
4	1	3	4	1	3	4	2	1	4	4	2	2	3	1	3	4

Q18	Q19	Q20	Q21	Q22	Q23	Q24	Q25	Q26	Q27	Q28	Q29	Q30
3	3	1	2	4	3	2	3	4	3	4	1	3

- 31)a)They are classified based on the method of reproduction.
b)No. It reproduces from spores.
c)It makes its own food through photosynthesis.

- 32)a)Yes, they respired as oxygen was used up.
b)i)Germination ii)seed leavers
c)i)It helps the animals conserve energy.
ii)It helps the animals cope with food scarcity/lack of food.

- 33)a)B: Respiratory C: Circulatory system
b)It breaks down the food to smaller piece to speed up digestion to help in swelling.
c)lungs.

- 34)a)Pond D. The plants would not have enough light to carry out photosynthesis/ to make food.
b)Amount of floating plants on the water surface that could block from entering the water.
c)i)Roots that traps air to keep it a float.
ii)Leaves growing above or floating on the water surface.

- 35)a)Cell A because it has a cell wall. Cell B because it has a cell wall and chloroplast.
b)Cell A can be found in the root. Cell B can be found in the stems/leaf that are green.

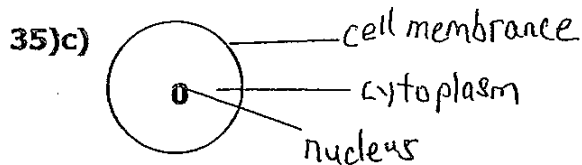

36)a) Enables the polar bear to walk on ice without slipping.

Help one another look out predators.

b) An adaptation is a special characteristic that enable the organism to cope with the conditions in its natural habitat. The conditions in another habitat are different so the adaptations may not be suitable.

c) False. Predators (like the tigers) use camouflage to increase their chance of catching their prey/so that can approach nearer to their prey without being detected.



b) The leaf used the carbon dioxide to carry out photosynthesis, so the amount of carbon dioxide in container X decreased.

c) It is used as a control to show that the change in the amount of carbon dioxide is due to the organisms present.

38)a)

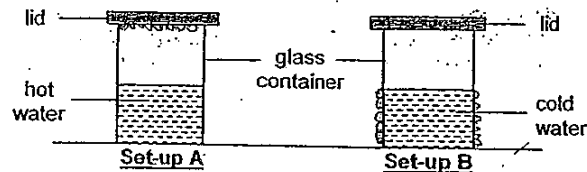

b)i) From the hot water vapour in the container/from the hot water.

ii) From water vapour in the air outside/outside the glass container in the surrounding air.

c) The hot water evaporates to form water vapour which rises. When the water vapour touches the cool inner surface of the lid, it condenses to form tiny water droplets.

39)a) For the ice cube to melt, it must gain heat from the water/water loss heat to the ice. So the temperature of water decreases.

b) Set-up B. The smaller ice cubes have a larger total surface area in contact with water than the bigger ice cubes of the same mass. Hence the smaller ice cubes can gain heat faster from the water to melt.

40)a) When the switch is on/ all the lamp in the house will be lighted up/ cannot control individual lamp.

When a lamp fuses/all the lamps will not light up.

40)b)

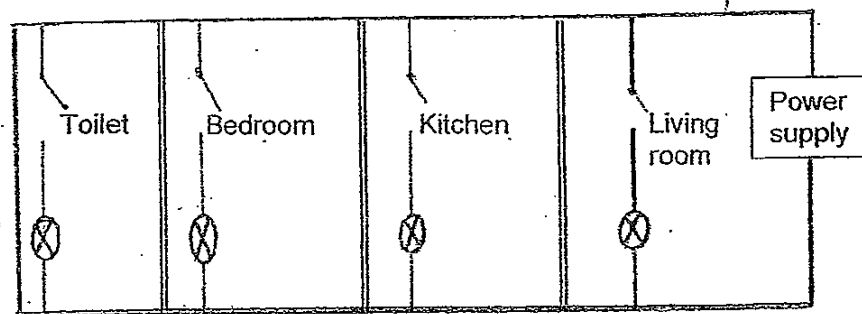

41)a)i)North-seeking pole ii)South-seeking pole

- b)1)Place the paper clip some distance from the N-pole of the bar magnet.
- 2)Move the paper clip slowly towards the N-pole.
- 3)Use the ruler to measure and record the distance at which the paper clip is attracted to the N-pole.
- 4)Repeat steps 1 to 3 with the S-pole of the bar magnet.
- 5)The pole that attract the paper clip from the further distance is stronger.

42)a)

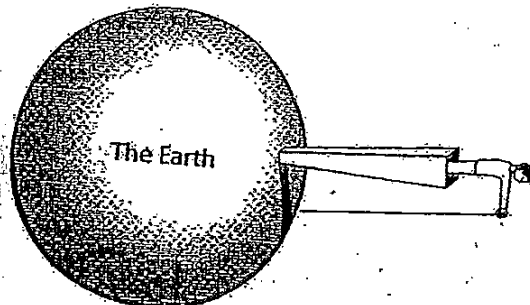

b)All object will fall forwards the Earth when dropped because of gravity/gravitational force/gravitational pull.

c)Gravitational potential energy \rightarrow kinetic energy + sound energy + Heat energy

43)a)It will increase because the cold water in the water gains heat from the hot water in the heat tube heat travels from the hot water in the test tube to that cold water in the beaker.

b)The hot food would lose heat to the air in the refrigerator and raises the temperature in the refrigerator. As a result, more electrical energy is required to cool the refrigerator to 4°C .

44)a)i)Position of the scale pan on the beam.

ii)The way the weight are placed on the scale pan.

b)The maximum weight the beam can support.

c)To have accurate result.

