

28

--	--	--	--	--	--	--	--	--	--

SINGAPORE CHINESE GIRLS' SCHOOL (PRIMARY)

PRIMARY SIX PRELIMINARY ASSESSMENT 2016

NAME: _____ ()

DATE: 26 August 2016

CLASS: PRIMARY 6

Parent's Signature:

**SCIENCE
BOOKLET A**

30 questions

60 marks

Total time for Booklets A & B: 1 h 45 min

DO NOT OPEN THIS BOOKLET UNTIL YOU ARE TOLD TO DO SO.

FOLLOW ALL INSTRUCTIONS CAREFULLY.

Part I (60 marks)

For each question from 1 to 30, four options are given. One of them is the correct answer. Make your choice (1, 2, 3 or 4). **Shade the correct oval (1, 2, 3 or 4) on the Optical Answer Sheet.**

1. Study the flow chart below carefully.

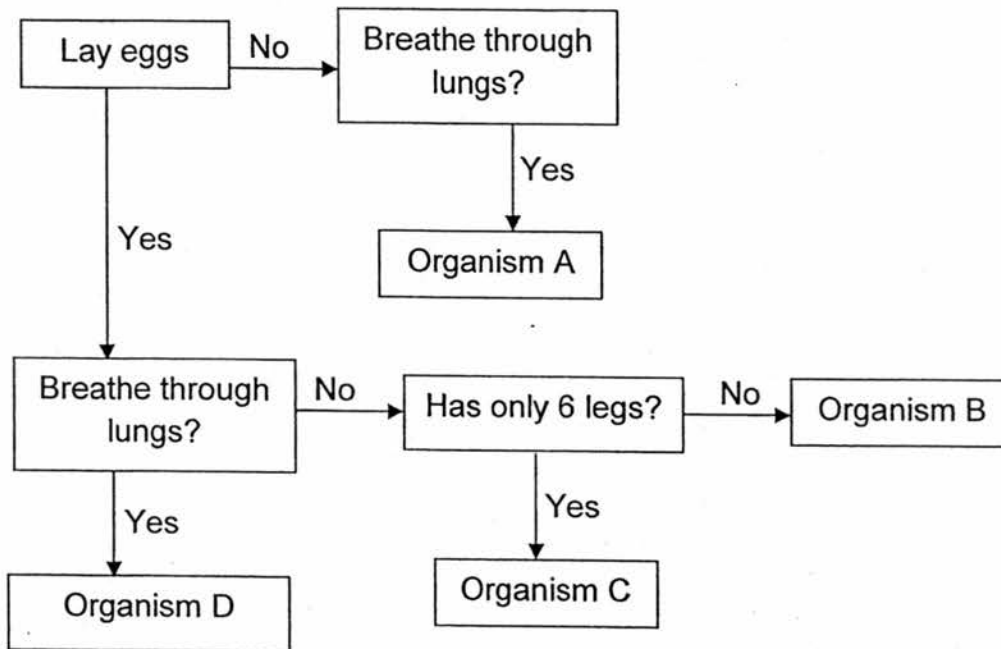

Based on the flow chart above, which of the organisms is an insect?

- (1) Organism A
- (2) Organism B
- (3) Organism C
- (4) Organism D

2. The graph below shows the amount of undigested food at each organ just before being passed to the next organ in the digestive system.

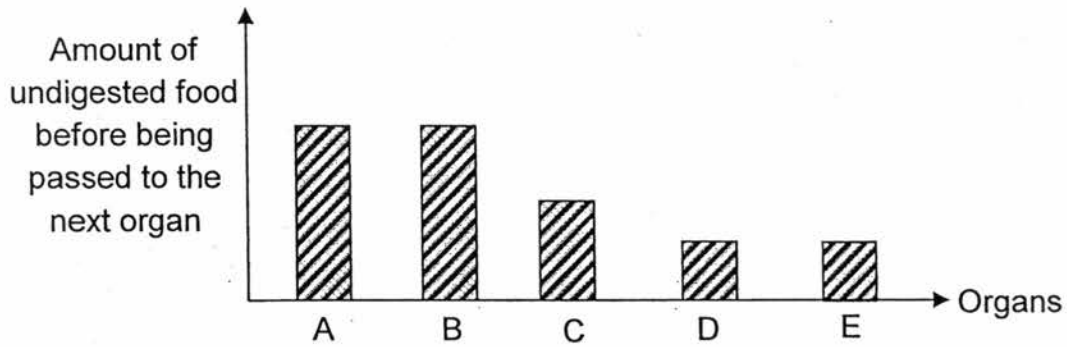

Based on the graph only, in which organs was food digested?

- (1) A and B
 (2) C and D
 (3) A, B and D
 (4) A, C and E
3. Kelly cut some cell samples from a hibiscus plant and observed them under a microscope.
 Which of the following cells are likely to come from a leaf and a root of the plant?

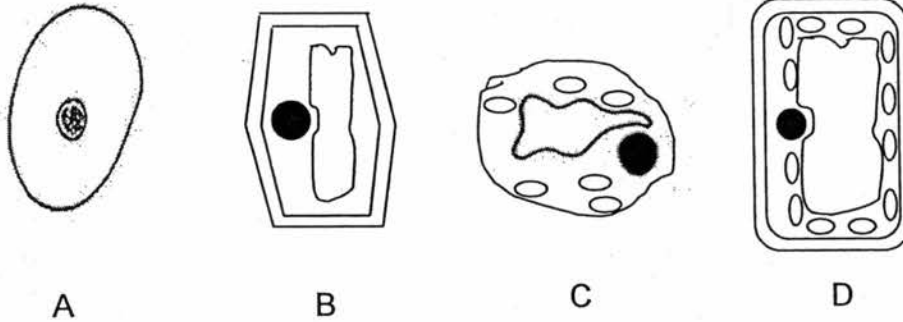

	Leaf	Root
(1)	B	D
(2)	C	A
(3)	D	B
(4)	C	B

4. Janice sealed some leaves in a clear plastic bag as shown below. Both the bag and leaves are at room temperature.

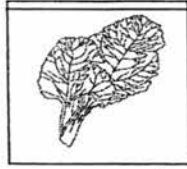

**Leaves sealed in
plastic bag for 1 hour**

Which of the following is likely to be observed after 1 hour?

- (1) The bag becomes deflated as the leaves take in more air.
- (2) The leaves become bloated as the leaves take in water vapour.
- (3) Water droplets can be seen inside the bag as the leaves gave out water vapour.
- (4) Water droplets can be seen outside the bag which is warmer than the water vapour in the room.

5. The doctor collected 4 different blood samples from Jana. The graph below shows the amount of carbon dioxide present in her blood.

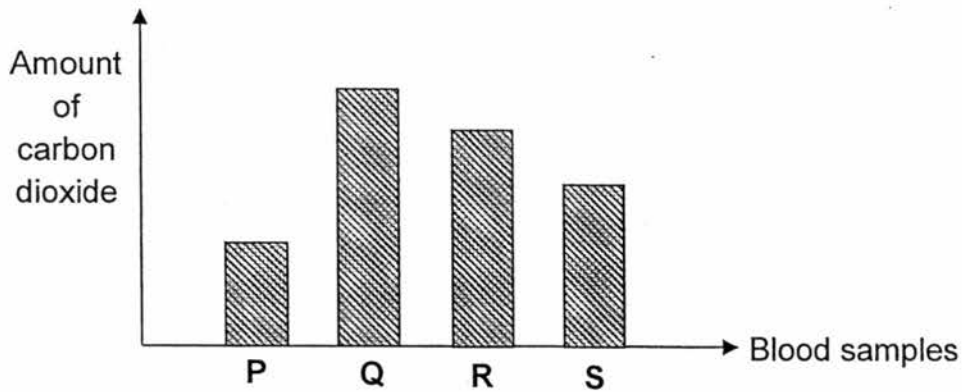

The diagram below shows Jana's heart with 4 main blood vessels, A, B, C and D and the directions of blood flow.

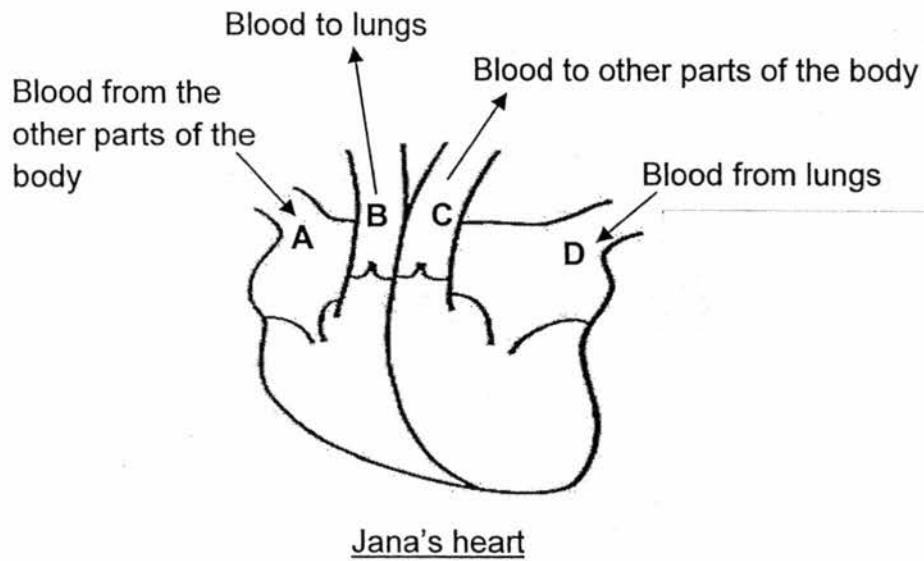

Which blood vessel was blood sample Q most likely collected from?

- | | |
|-------|-------|
| (1) A | (3) C |
| (2) B | (4) D |

6. Yale removed only food-carrying tubes from the outer part of a plant as shown below.

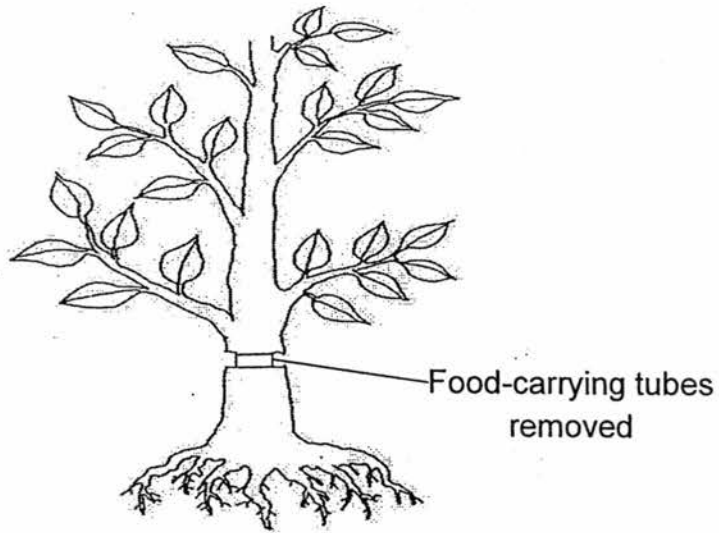

Which of the following diagrams will represent the appearance of the stem after some time?

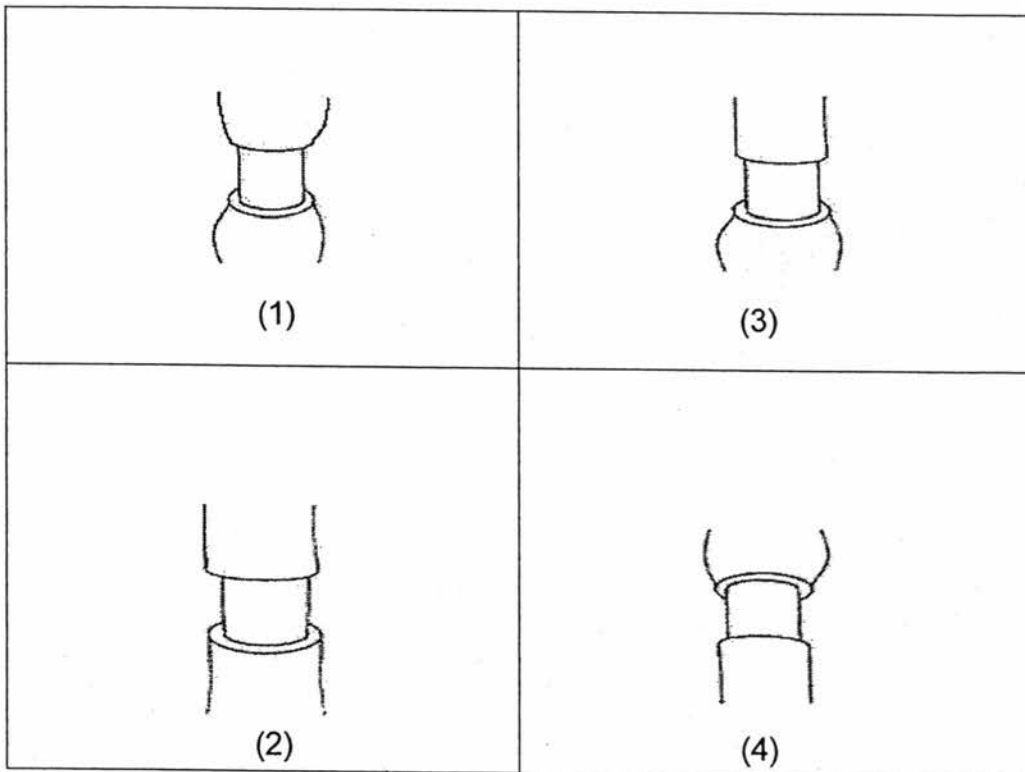

7. Yuki kept 3 plants, X, Y and Z, each in a black box. She gave each plant equal amounts of water. In each set-up, she kept the distance between the plant and the light source constant but she changed the size of the opening of the black boxes as shown below.

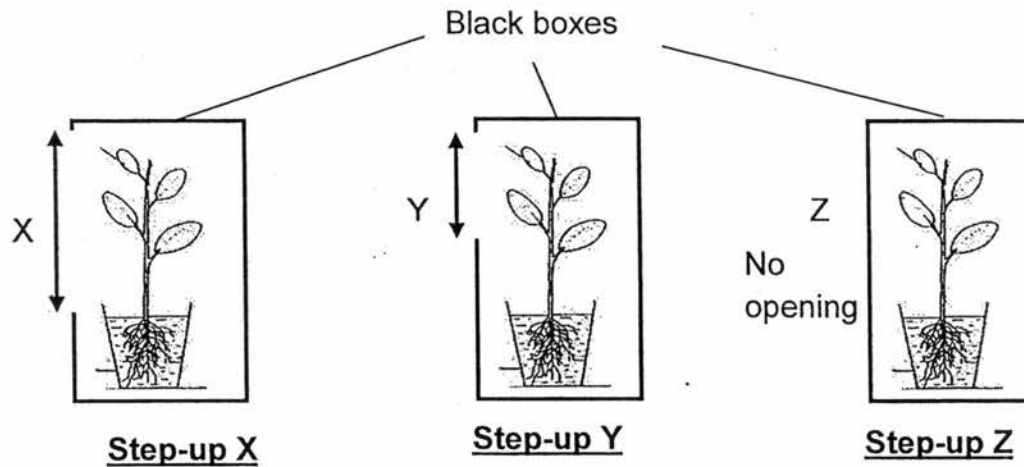

After one week, she plucked a leaf from each set-up and put equal amount of iodine onto each leaf and observed the colour of the iodine on the leaves.

Iodine test: Iodine will turn dark blue in the presence of starch.

Which one of the following results of the iodine colour correctly matches her observation of Plants X, Y and Z?

	Iodine remains brown	Iodine turned dark blue immediately	Iodine turned dark blue after 5 minutes
(1)	X	Y	Z
(2)	X	Z	Y
(3)	Y	Z	X
(4)	Z	X	Y

8. The diagram below shows a plant.

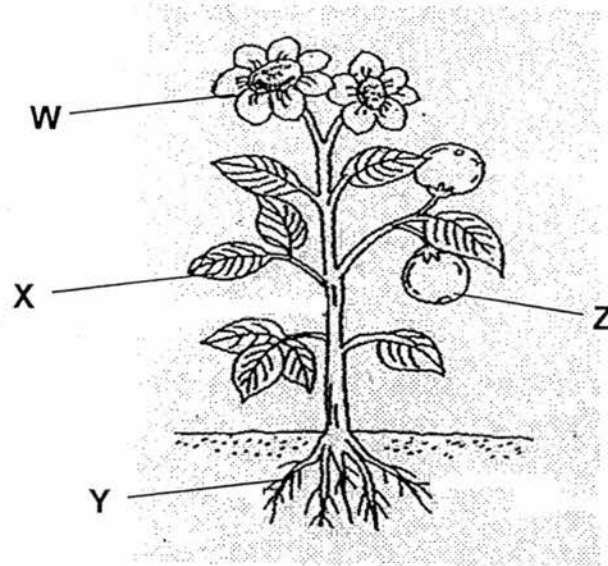

Part	Function
W	Help the plant to produce seeds.
X	Allow plant to take in water to make food.
Y	Hold the plant upright.
Z	Help the plant to make food.

Which plant part has been matched correctly to its function?

(1) W

(3) Y

(2) X

(4) Z

9. The food web below shows the relationship among organisms, P, Q, R, S, T and U.

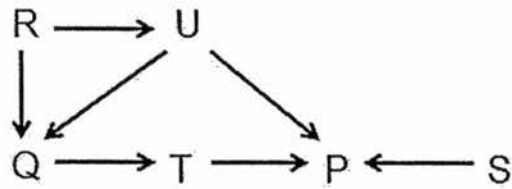

Which of the following shows the correct classification of the organisms?

	Food Producer	Carnivore	Omnivore
1)	R	T and S	Q and P
2)	R and S	T	Q and P
3)	R and S	T and P	Q
4)	R	T, P and S	Q

10. Study the food chain below carefully.



Based on the food chain above, which one of the following statements is correct?

- (1) Organism D is likely to have the highest population among A, B, C and D.
- (2) Organism C is likely to have a lower population than Organism B.
- (3) Organism A does not need any energy to stay alive.
- (4) Organisms B, C and D get equal amounts of energy from organism A.

11. Jason has 2 adult plants close to each other in her garden as shown below. Plant A and B are of the same species. Jason provided each plant with equal amounts of water and sunlight each day.

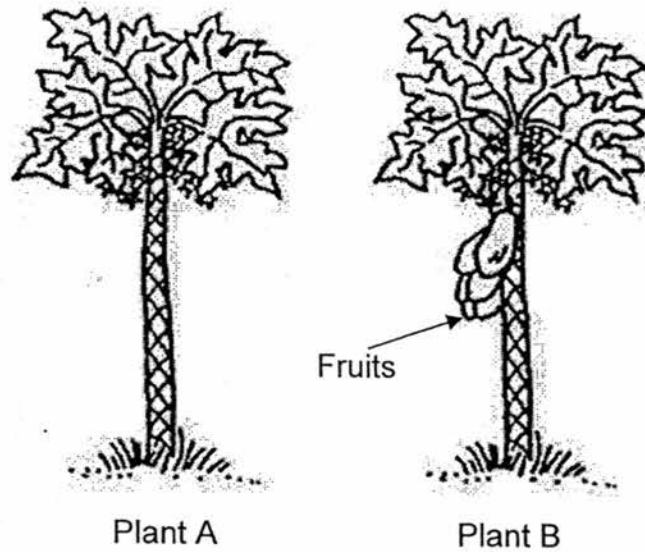

Only adult plant B bears fruits.
The flowers of Plant A and Plant B look different from each other even when they are the same species.
What can Jason most likely infer about the flowers of plants A and B?

- (1) Both Plant A and Plant B has only males flowers.
- (2) Both Plant A and Plant B have both male and female flowers.
- (3) Plant A has only female flowers but plant B has only male flowers.
- (4) Plant A has only male flowers but Plant B has only female flowers.

12. Animal A has strong jaws but it does not chew its food. As Animal A swallows its prey, bits of food get stuck in its teeth, causing possible diseases.

Animal B picks and eats the bits of food in Animal A's mouth without getting harmed or eaten by Animal A.

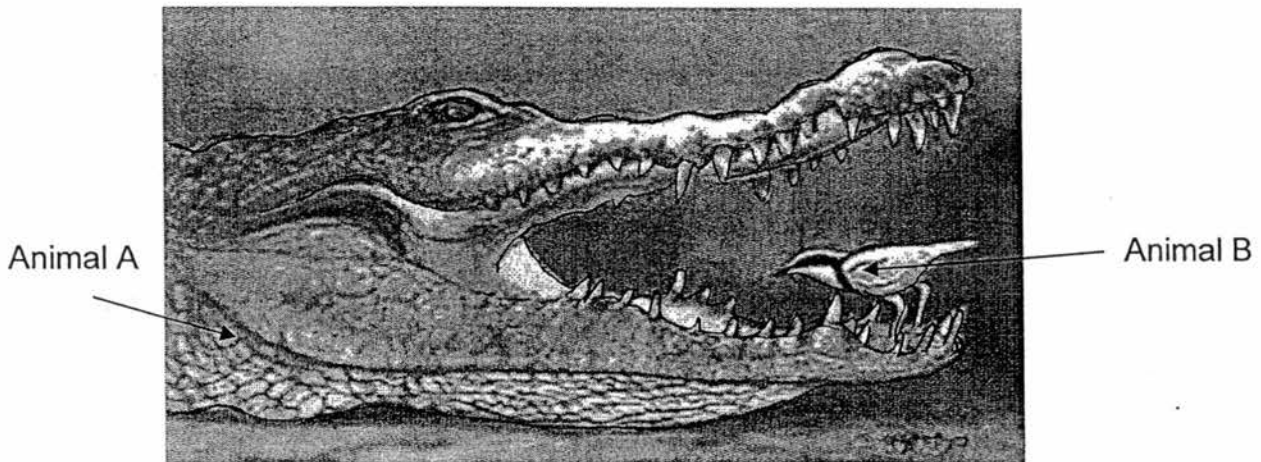

Which of the following is most likely correct about the relationship between Animal A and Animal B?

- (1) Only A benefits from the relationship.
- (2) Animal A can survive better without Animal B.
- (3) Both animals help each other survive better.
- (4) Animal B can survive better without Animal A.

13. The graph below shows the relationship between the wind speed and the distance of seeds/fruits dispersal by plants A and B.

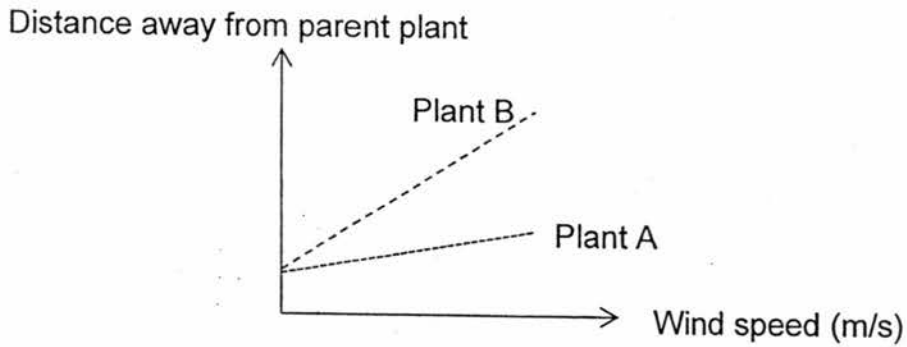

Which one of the following characteristics correctly represents the fruits/seeds of plants A and B?

	Plant A	Plant B
1)	Has wing-like structure	Has dried pods
2)	Has wing-like structure	Has hooks
3)	Has fibrous husk	Has dried pods
4)	Has dried pods	Has wing-like structure

14. Study the diagram of the human female reproductive system shown below.

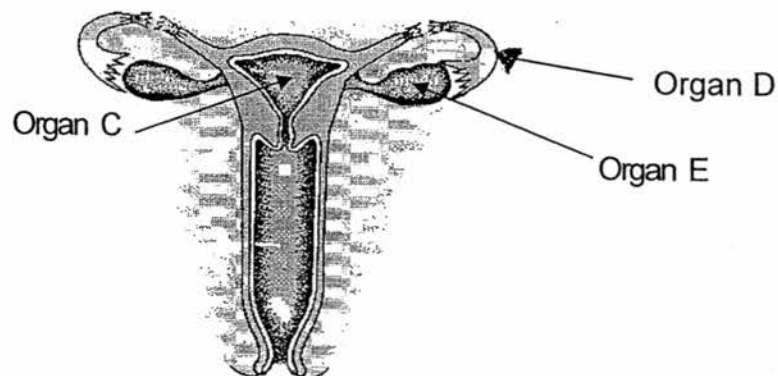

Which one of the following correctly represents Organs C, D and E?

	Egg travels through here	Eggs are produced here	Foetus develops here till birth
1)	Organ C	Organ D	Organ E
2)	Organ D	Organ C	Organ E
3)	Organ D	Organ E	Organ C
4)	Organ E	Organ C	Organ D

15. The graph below shows the number of days for each stage of the life cycle of organism S and P.

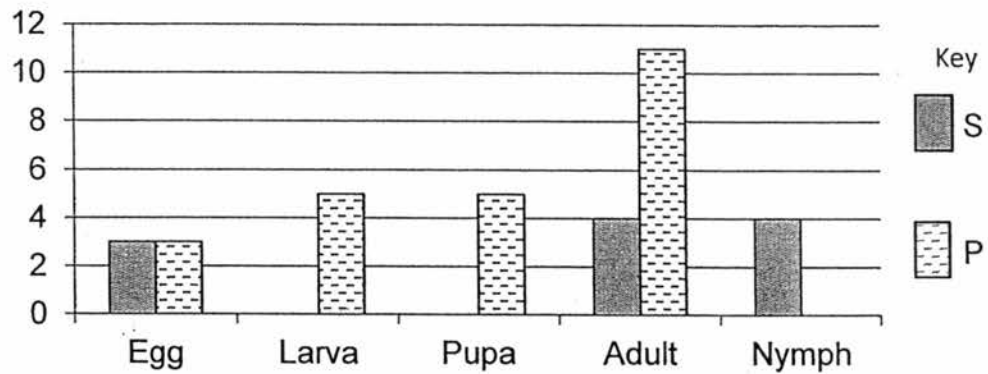

Based on the graph above, which of the following statements are true?

- A: Organism S has 3 stages in its life cycle.
- B: Organism S has longer life span than Organism P.
- C: The male of organism P dies immediately after fertilizing the eggs.
- D: It takes 7 days for organism S to become an adult after the eggs are laid.

- (1) A and D only
- (2) B and D only
- (3) B and C only
- (4) A, B and D only

17 Study the circuit below carefully.

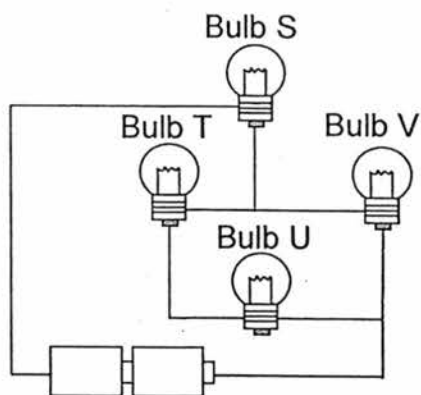

Which bulbs will light up if bulb V is fused?

- (1) Bulb S and T only (3) Bulb S, T and U
 (2) Bulb S and U only (4) None of the bulbs

18. The diagram below shows four circuits, A, B, C and D with different arrangements of identical batteries and identical bulbs. The bulbs in all four circuits light up.

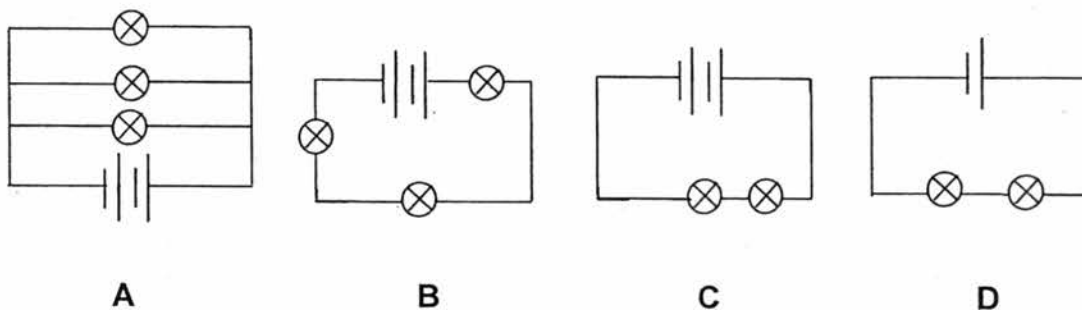

Which one of the following set-ups shows the correct brightness of the bulbs?

	Brightness of bulb			
	Dimmest			>Brightest
1)	A	C	B	D
2)	B	C	D	A
3)	D	B	C	A
4)	C	D	B	A

19. Pauline made a game set as shown below. The bulb lights up when the loop of Object X is in contact with Object Y.

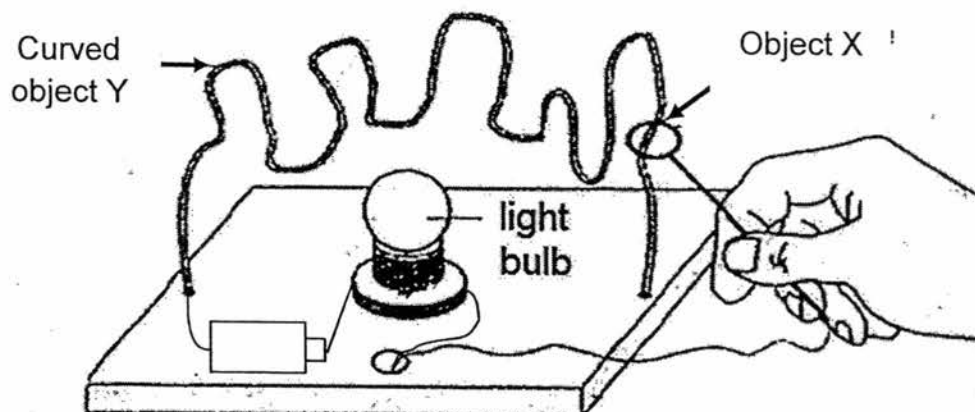

Based on the game set above, what can the player conclude about objects X and Y?

- (1) Only Object X is a conductor of electricity.
- (2) Only Object Y is a conductor of electricity.
- (3) Both Objects X and Y are non-conductors of electricity.
- (4) Both Objects X and Y are conductors of electricity.

20. Jessica made 4 toy cars, A, B, C and D, as shown below. There is a magnet on the top of each toy car.

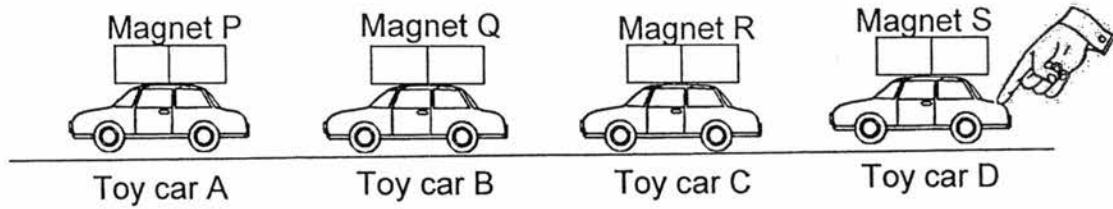

The toy cars are moving at a distance away from each other when Jessica pushes **only** toy car D. Which one of the following correctly shows how the magnet on each toy car is arranged?

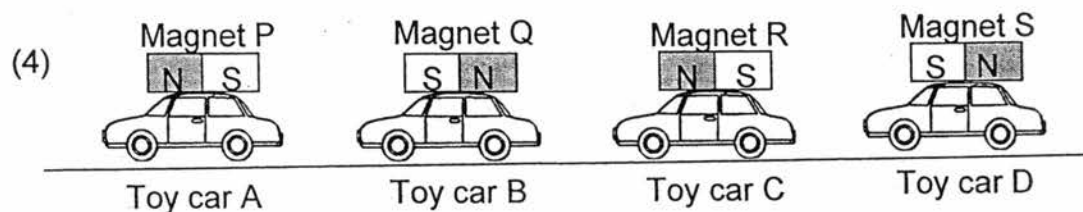
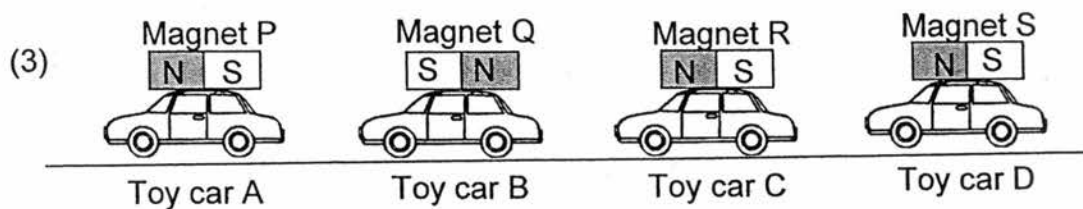
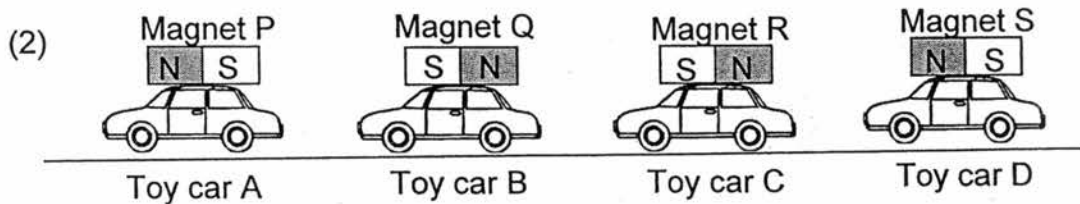
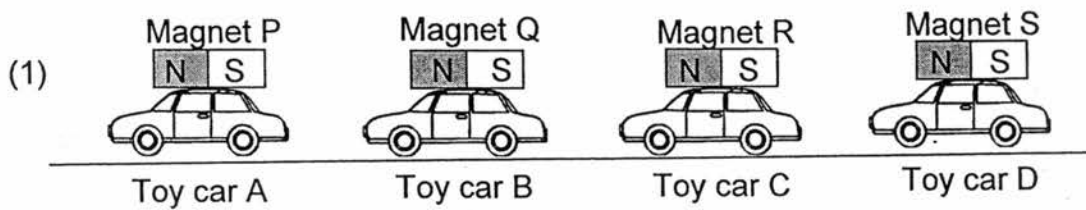

21. The table below shows the change in temperature of Substance X as it was heated over 60 minutes. Before heating, Substance X was a solid.

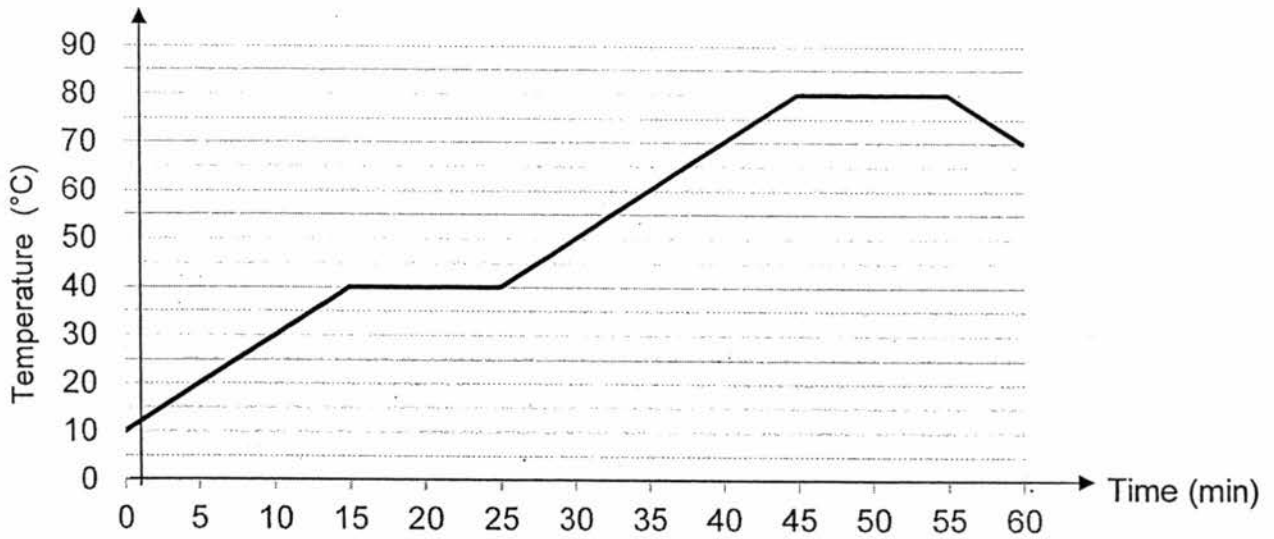

Which one of the following correctly represents the melting and boiling point of Substance X?

	Melting point	Boiling point
1)	40°C	80°C
2)	40°C	100°C
3)	10°C	80°C
4)	0°C	100°C

22. Shaun placed a piece of bread into a sealed bag. The bread contained 15% of moisture.

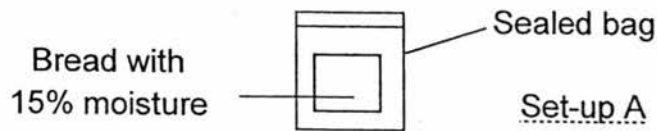

Which one of the following set-ups should Shaun choose to compare with Set-up A so that he can conclude that moisture is needed for decomposition to take place?

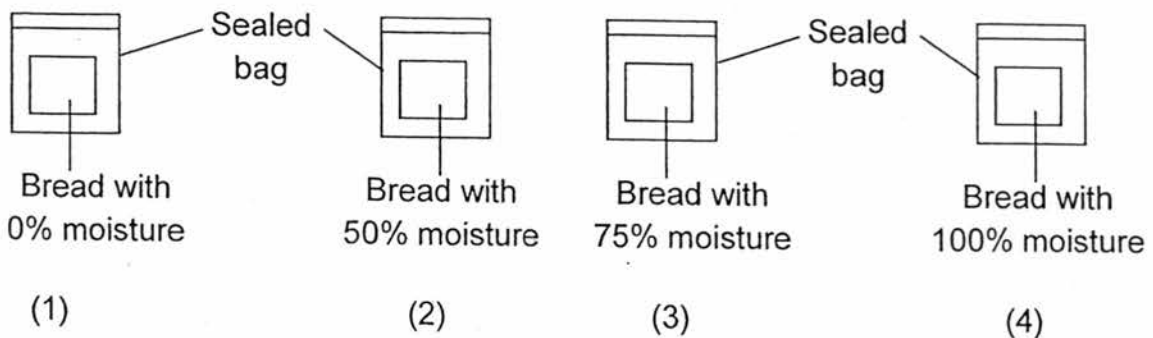

23. Ryden put some seeds into 4 small containers for the seeds to germinate. The seeds are placed under different conditions as shown in the table below.

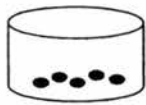

A
Dry at 0°C

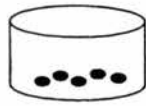

B
Dry at 30°C

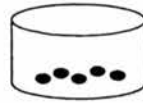

C
Wet at 0°C

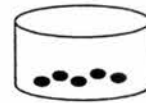

D
Wet at 30°C

Condition	Observation
A	Did not germinate
B	Did not germinate
C	Did not germinate
D	Germinate

Based on her experiment, which are the conditions required for seeds to germinate?

- (1) Water and air
- (2) Water and warmth
- (3) Air and warmth
- (4) Water, air and sunlight

24. The set-up below shows light from a torch shining through 3 cut-outs, R, S and P, which are made of different materials as shown below.

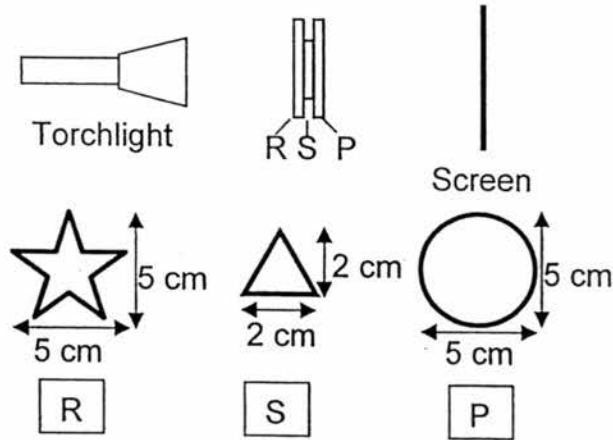

The diagram below shows the shadow that was formed on the screen.

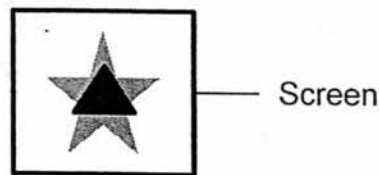

Based on the shadow formed above, which of the following bar graphs show the amount of light that had passed through Objects R, S and P?

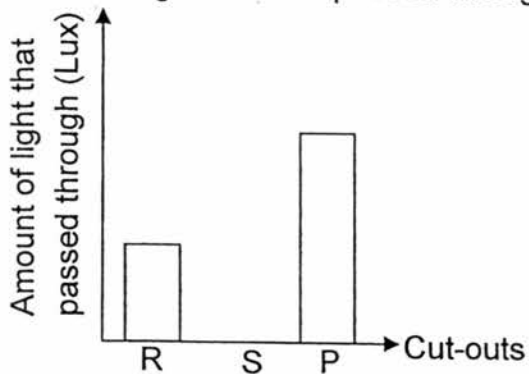

(1)

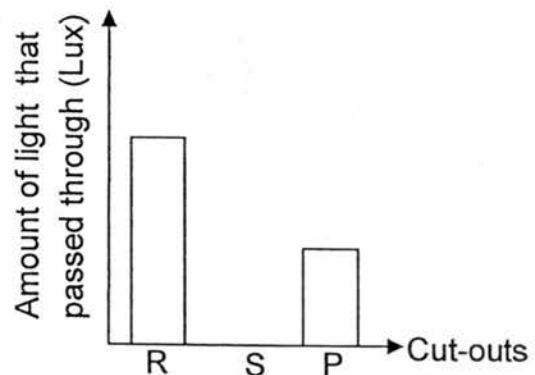

(3)

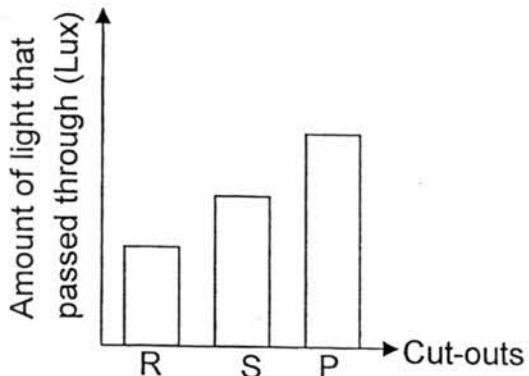

(2)

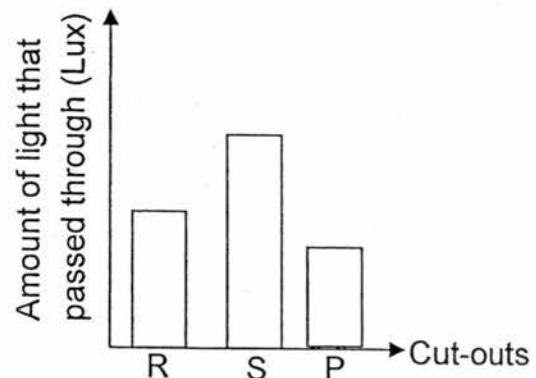

(4)

26. Beaker A contained water while Beaker B contained marbles as shown in the diagrams below.

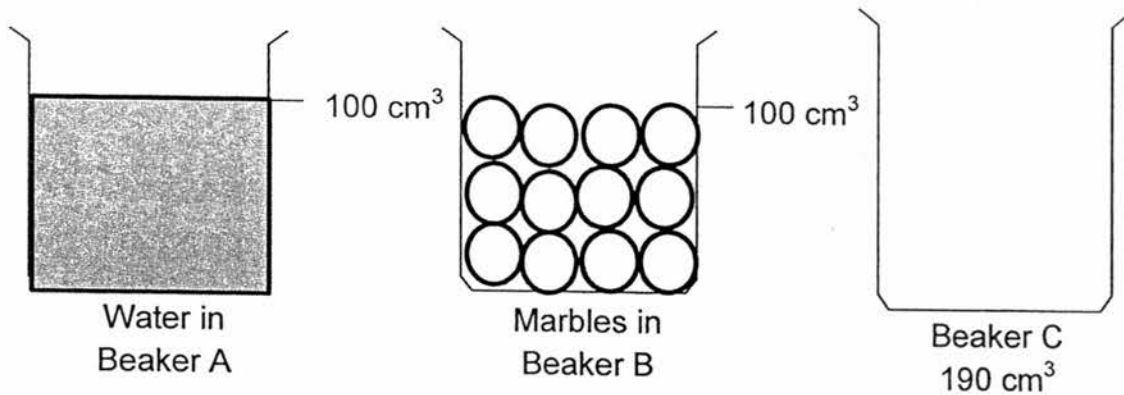

The capacity of Beaker C is 190 cm^3 , but it can hold all the water from Beaker A and all the marbles from Beaker B without overflowing. Why is this possible?

- (1) The marbles will take up the space occupied by the water.
- (2) Water can be compressed to take up less of the space.
- (3) Some of the water takes the place of the air occupying the spaces in between the marbles.
- (4) Some of the marbles are shifted to occupy less spaces so that the water can be poured in without overflowing.

27. Olive wets 3 identical towels, A, B and C, with equal amounts of water. She then hangs the 3 towels, A, B and C, using different ways as shown below.

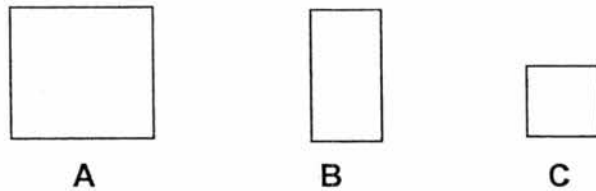

Towel A is the original size of the towel. Towel B is folded once into halves. Towel C is folded twice into quarters. At the end of 5 hours, she weighs them to compare their mass.

What is the aim of Olive's experiment?

- (1) She wants to find out if the size of the towel will affect the mass of the towels.
 - (2) She wants to find out if the exposed surface area of the towels will affect the rate of evaporation.
 - (3) She wants to find out if the size of the towel will affect the rate of evaporation.
 - (4) She wants to find out if the mass of the towels will affect the number of folds of the towels.
28. The metal ball **cannot** pass through the metal ring at first.

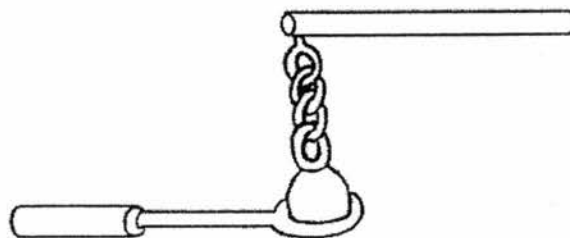

State and explain what will happen after the ball is put in iced water for 3 minutes.

	Result	Explanation
(1)	Ball can pass through.	The ball contracted upon cooling.
(2)	Ball can pass through.	The ring expanded upon heating.
(3)	Ball cannot pass through.	The ring contracted upon cooling.
(4)	Ball cannot pass through.	The ball expanded upon heating.

29. Alice conducted an experiment using a spring and some loads. She measured the length of the spring as she increased the mass of the loads in the diagram below.

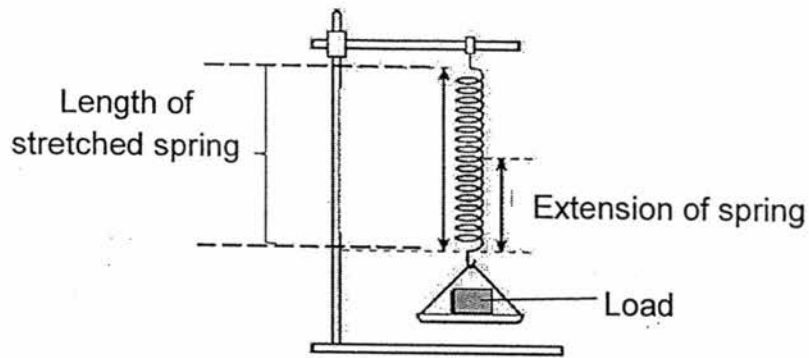

Next, she represented her results of her experiment by plotting 4 different graphs as shown below.

Which of the graphs correctly represents Alice's results?

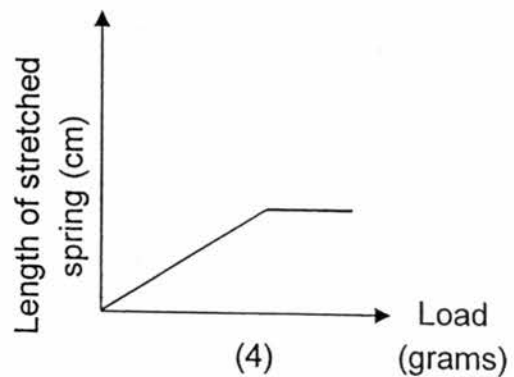
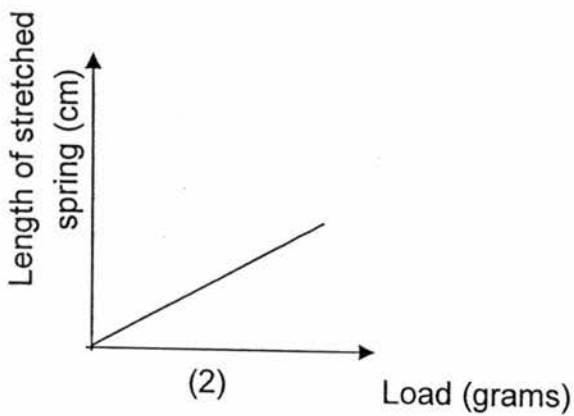
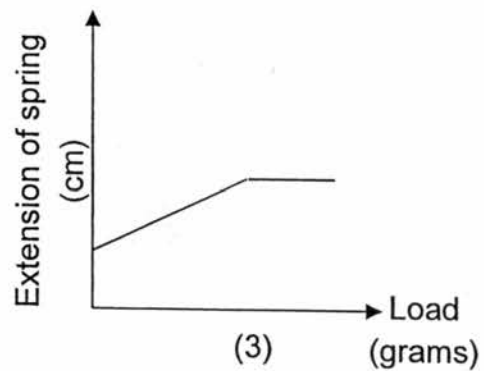
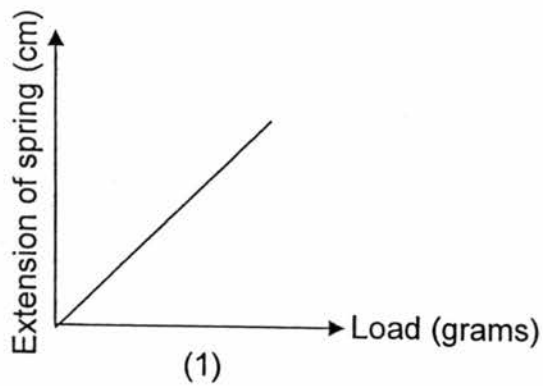

30. The diagram below shows some plastic sheets laid on the mountains after the all the plants are removed from it. There is a busy road at the bottom of the mountains as shown below.

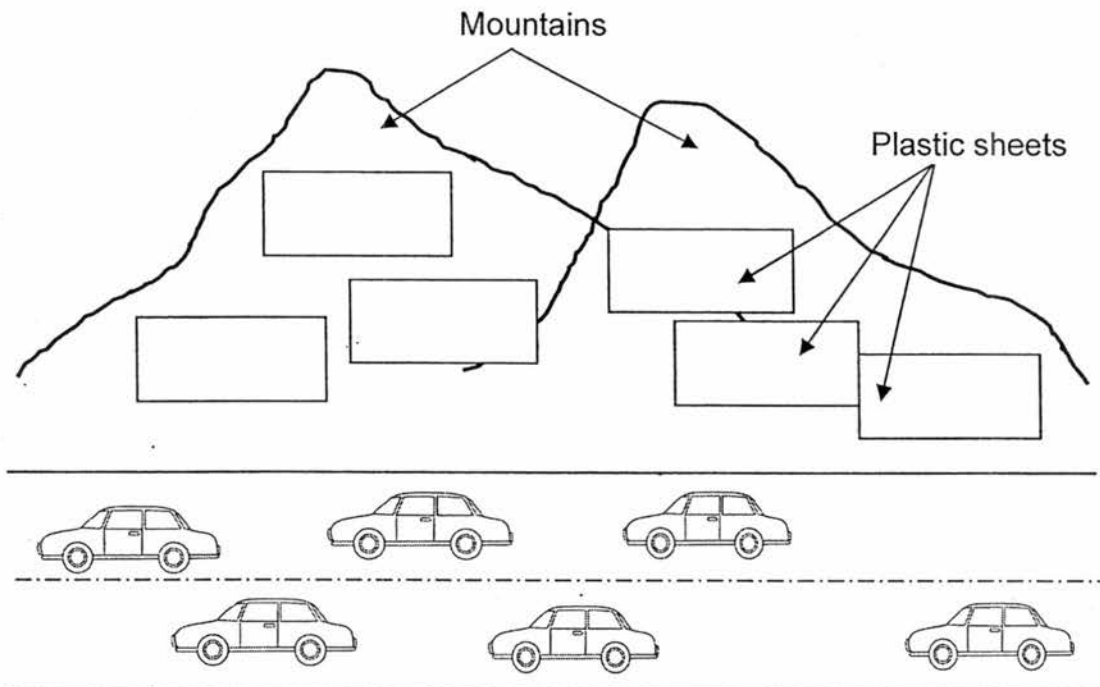

The purpose of having the big plastic sheets on the mountains after deforestation is to _____.

- (1) create new space for plants to grow.
- (2) prevent the rain from washing the soil down.
- (3) prevent the mountains from getting wet and flooded by rain.
- (4) protect the motorists from air pollution caused by flying dust from the soil.

End of Booklet A

					-	
--	--	--	--	--	---	--

SINGAPORE CHINESE GIRLS' SCHOOL (PRIMARY)

PRIMARY SIX PRELIMINARY ASSESSMENT 2016

NAME: _____ ()

DATE: 26 August 2016

CLASS: PRIMARY 6 SY / C / G₁ / SE / P

Parent's Signature:

SCIENCE

BOOKLET B

	Total Actual Marks	Total Possible Marks
Booklet A		60
Booklet B		40
Total		100

14 questions

40 marks

Total time for Booklets A & B: 1 h 45 min

DO NOT OPEN THIS BOOKLET UNTIL YOU ARE TOLD TO DO SO.

FOLLOW ALL INSTRUCTIONS CAREFULLY.

Part II (40 marks)

Answer all the following questions.

31. Study the flowchart about living things below.

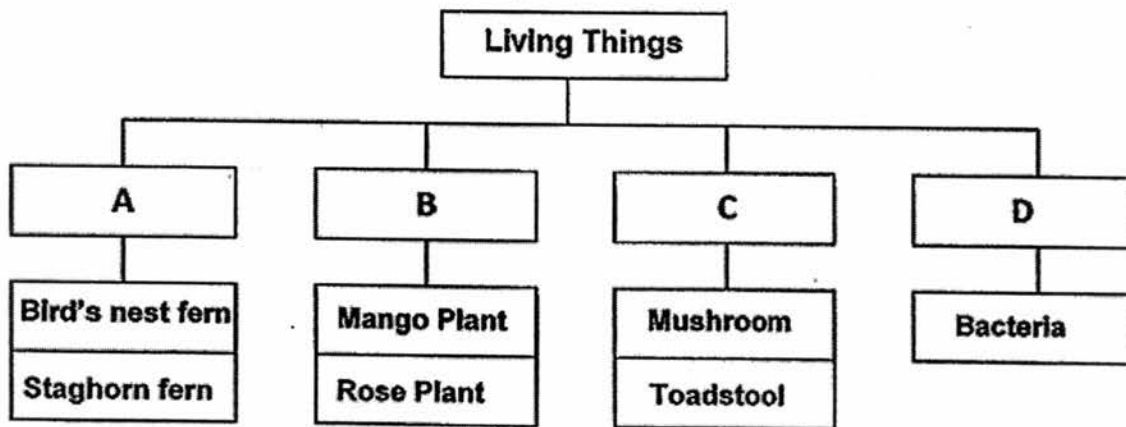

a) Which 2 groups reproduce by spores? (1m)

b) Which 2 groups break dead and waste matter down into simpler substances? (1m)

c) Increasing the populations of which 2 groups is able to help Man reduce global warming? Explain your answer. (2 m)

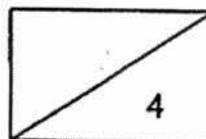

32. The food web below shows the food relationships of Organisms, A, B, C, D and E. Study the food web to answer questions (a) and (b).

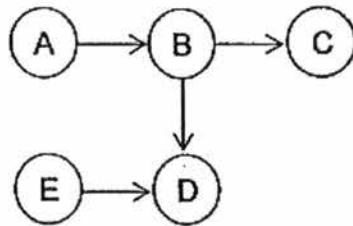

a) How would the decrease in the number of Organism C cause the number of Organism D to increase? (1m)

b) The diagram below shows the seeds of Organisms A,

Juicy flesh and
non-digestible
seeds

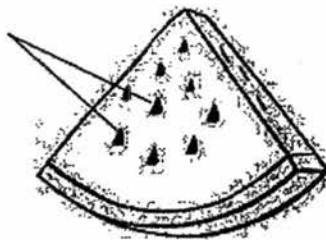

Explain how Organism B is able to help Organism A in Organism A's seed dispersal. (2m)

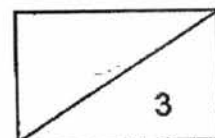

33. Lianne observed and recorded the physical conditions of 4 different types of communities in the table below.

Conditions	Community P	Community Q	Community R	Community S
Sunlight	Bright	Shady	Bright	Shady
Temperature	33° C	25° C	29° C	27° C
Moisture is present	A little	Moist	Very Wet	Very Wet
Examples of organisms found	Grasshopper Grass	Wood louse Bracket fungus	Coconut trees Horseshoe crab	Hydrilla Pond skater

- a) Based on the conditions of the Communities P, Q, R and S, given in the table above, identify which of them are the following communities. (1m)
- i) seashore community: _____
- ii) rotting log community: _____
- b) State one thing that the grasshoppers in Community P will do to survive if all the plants in the habitat are removed because of a building project. (1m)

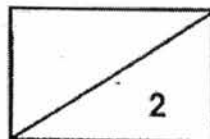

34. a) Eden constructed an electric circuit as shown below.

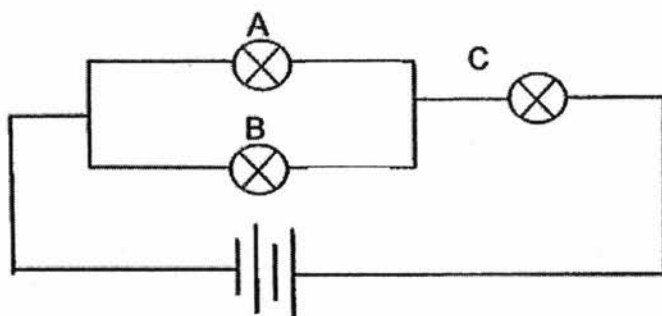

She needed 2 switches, M and K, that could control light bulbs A, B and C as shown in the table below.

Bulb	Only switch K is closed	Only switch M is closed
A	lights up	Did not light up
B	Did not light up	lights up
C	lights up	lights up

Mark an "K" to represent switch K and "M" to represent switch M in the above circuit . (1m)

b) Jenny has a doll house which has 3 rooms as shown below. There are 2 light bulbs in the bedroom, 1 light bulb in the kitchen and 3 light bulbs in the living room. 2 batteries are used to light up her doll house.

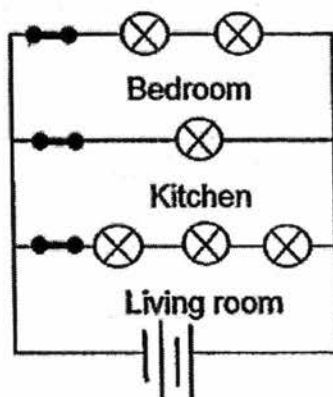

Which one of the rooms will have the dimmest bulbs? (1m)

35. The diagram below shows the water level during the high tide and low tide of a habitat which Plant W lives in. The adult of Plant W grows in mud.

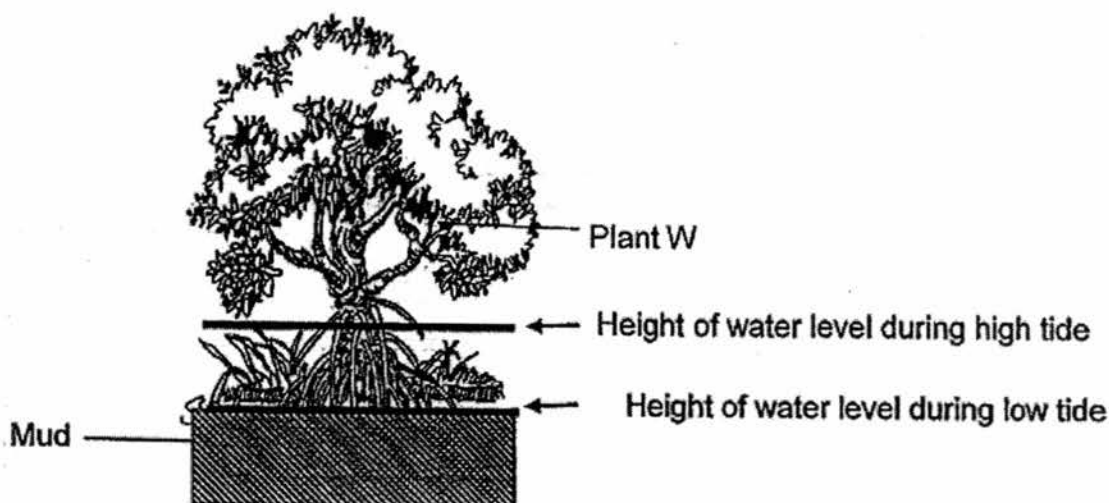

The seeds of plant W does not fall when ripen. The seeds start to germinate in the fruit while it is on the parent plant W. The fruits of Plant W will drop during low tide after the seeds have germinated. The seeds then continue to grow under their parent plant.

The fruit of Plant W hangs downwards on adult Plant W.



Shape A



Shape B

- a) Explain why Shape A works better than Shape B as the seed of Plant W. (1m)

- b) Explain how germinating the seeds on the tree can be an advantage to the plant. (1m)

- c) Explain how dropping the seeds below the parent tree can be an disadvantage to the plant. (1m)

36. Lily took a can of drink, Can A, weighing 225g from the refrigerator and left it on the weighing scale in the Room A for 15 minutes. She then observed that Can A became heavier as shown below.

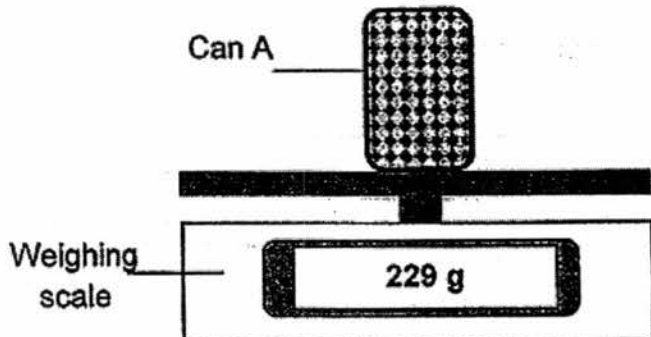

Lily took a similar can of drink weighing 225g, Can B, from the refrigerator and left it on the weighing scale for 15 minutes in Room B.

The temperature of the 3 areas are specified in the table below.

Area	Temperature
Refrigerator	4°C
Room A	24°C
Room B	16°C

- a) Circle the most likely mass of Can B 15 minutes after it was taken out of the refrigerator. (1m)

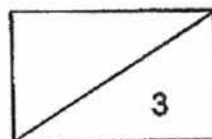

224g	227g	230g
------	------	------

- b) Explain your answer in (a). (2m)

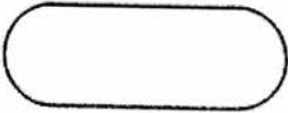
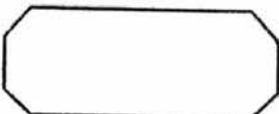

37. Kelly's class is designing a float to take part in a race with other classes. They had to decide on the shape of the float which will allow them to pull the float most quickly along the swimming pool.

The table below shows 3 shapes, X, Y and Z, Kelly's class has come up with.

Shape	Top View of the Float
X	
Y	
Z	

Which shape should Kelly's class choose if they want to win the race?
Explain. (2m)

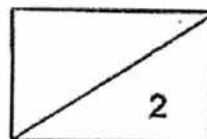

38. The diagram shows how an instant household water heater works.

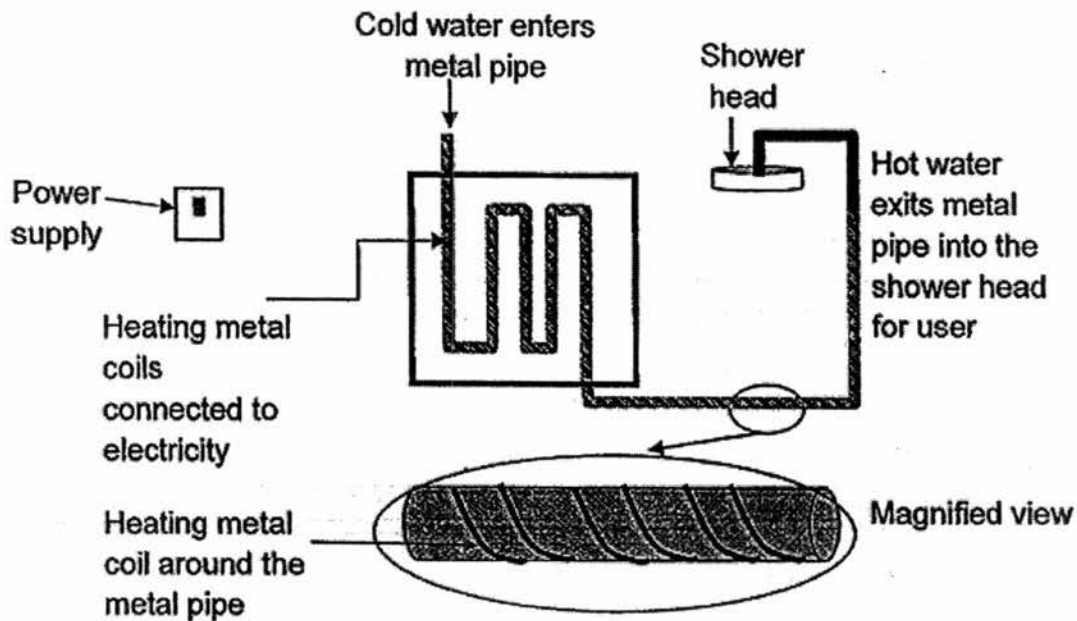

a) Based on the diagram above, state in the boxes below how energy changes in the instant water heater to provide hot water for the user. (1m)

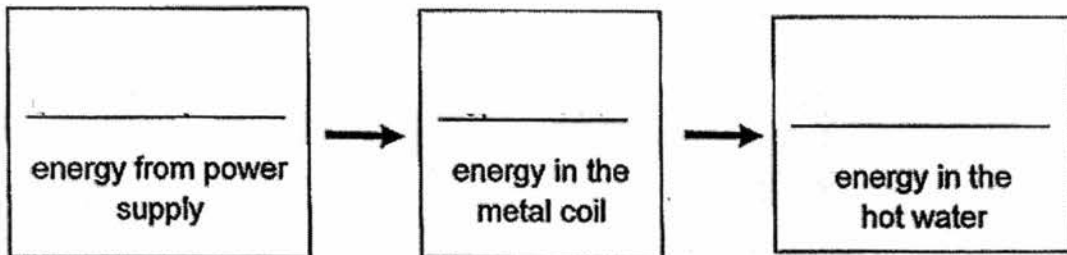

b) Explain what will happen to the rate of heating the water if the following changes are made. (2m)

i) Metal pipe is made thicker without changing the material:

ii) More heating metal coils are coiled round the pipe:

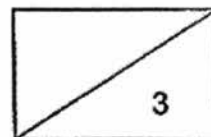

39a. Study the 3 graphs below carefully.

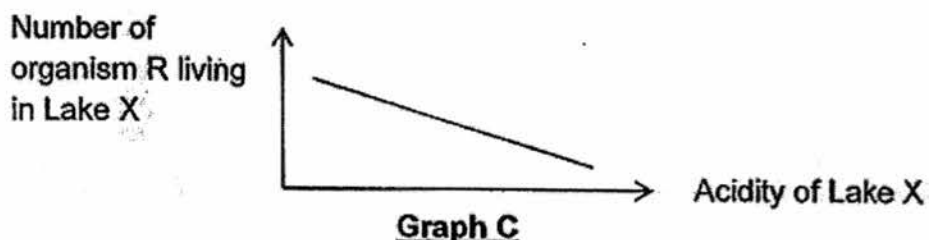
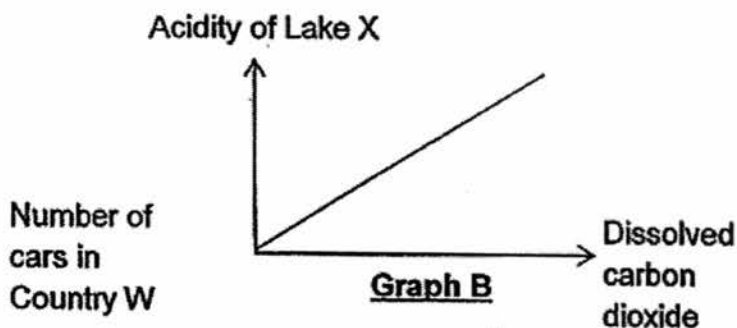
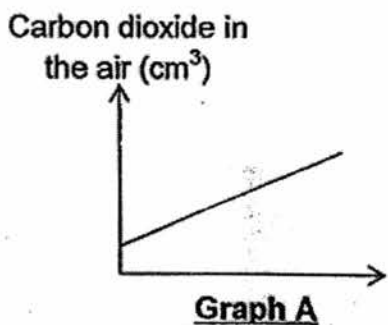

Based on the 3 graphs above, state the relationship between the number of cars in Country W and the number of organism R living in Lake X. (1m)

39b. The graph below shows how the number of factories in Country H affects the acidity level of the rain water in Country H.

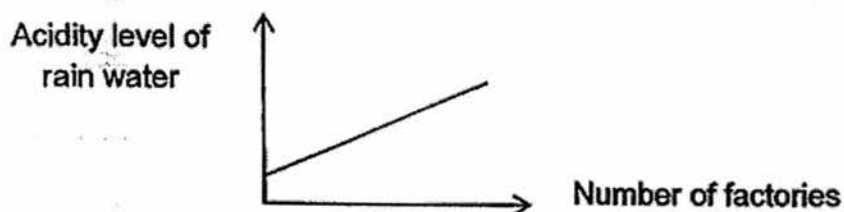

Explain why a higher number of factories changes the acidity level of the rain water. (2m)

40. In an experiment, Rachel had to find out whether Rods A, B and C are magnets, magnetic objects or non-magnetic objects.

The 3 rods, Rods A, B and C are tested with a bar magnet.

<p>J is attracted by the S-pole and U is attracted by the N-pole.</p> <p style="text-align: center;">Rod A</p> <p style="text-align: center;">J U</p>	<p>G and H are attracted by the N-pole.</p> <p style="text-align: center;">Rod B</p> <p style="text-align: center;">G H</p>	<p>Q is attracted by the N-pole but V is repelled by the N-pole.</p> <p style="text-align: center;">Rod C</p> <p style="text-align: center;">Q V</p>
--	--	---

Complete the table below by writing A, B and/or C to identify the rods described. (2m)

	Description	Rod or Rods
a)	It is a magnetic material.	
b)	It is definitely not a magnet	
c)	It is definitely a magnet	
d)	Not possible to tell if it is a magnet or not.	

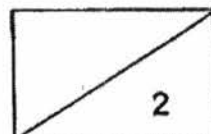

41. The diagrams below show the life cycles of Animal X, Animal Y and Animal Z.

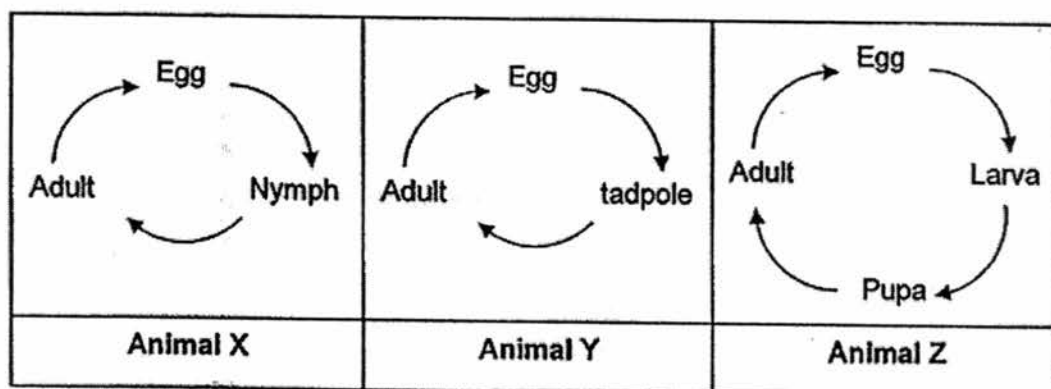

- a) State one similarity between the life cycles of Animal Y and Animal Z that is not shared with the life cycle of Animal X. (1m)

- b) Animal Y lays eggs in water and the tadpole lives in water while the adult mostly lives on land.
What is the advantage to Animal Y when the young and adult live in different places? (1m)

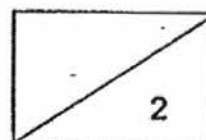

42. Ben arranged some blocks as shown below. He then pushed only the first block and the rest of the blocks toppled over in a line.

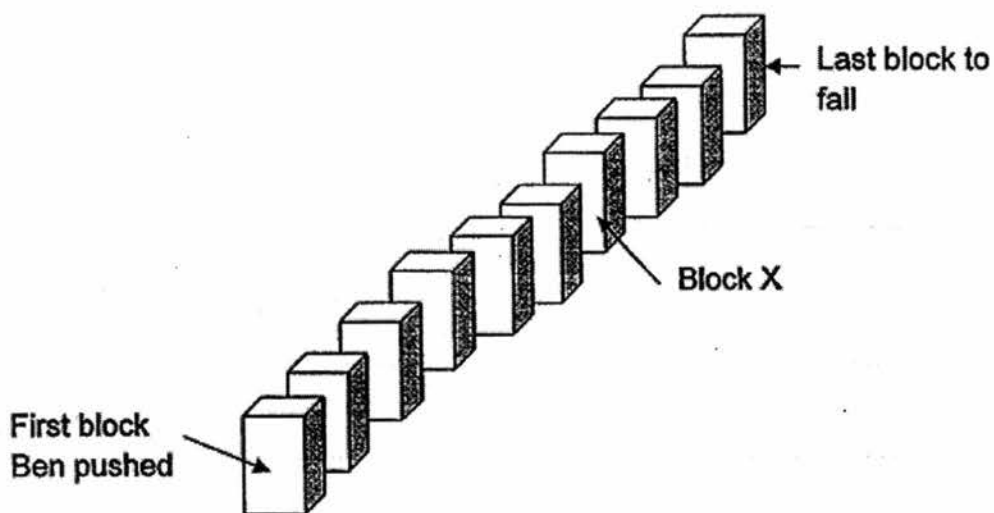

- a) Explain how the last block had the energy to move and fall. (1m)

- b) When the last block fell and hit the ground, what forms of energy did the kinetic energy convert into? (1m)

- c) What will happen if Block X indicated in the diagram is removed before Ben pushes the first block? Explain your answer. (1m)

- d) Ben wanted to use blocks made of different materials. He had 5 Styrofoam blocks and 5 metal blocks. He was advised to place all the 5 metal blocks at the start and all the 5 Styrofoam blocks towards the end. Explain why Ben should take this advice. (1m)

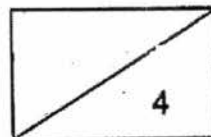

43. a) Kelly placed 12 identical raw chicken drumsticks into 2 identical ovens, A and B as shown below. In Oven A, the drumsticks were placed close to one another. In Oven B, the drumsticks were placed in 2 layers and well-spaced apart.

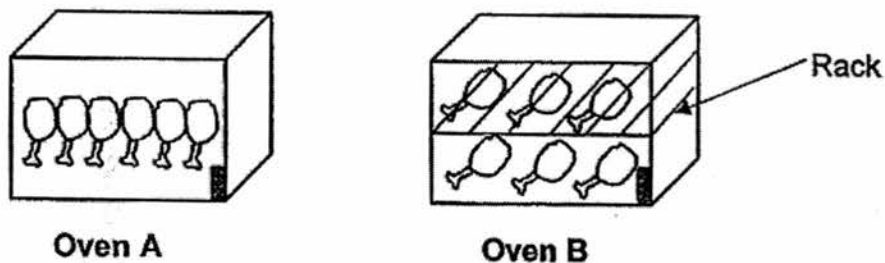

Explain why the drumsticks in Oven B were cooked faster than in Oven A. (2m)

- b) Kelly had 3 containers made of material E, F and G. She put an equal amount of milk in the containers before putting them in a tray of hot water as shown below.

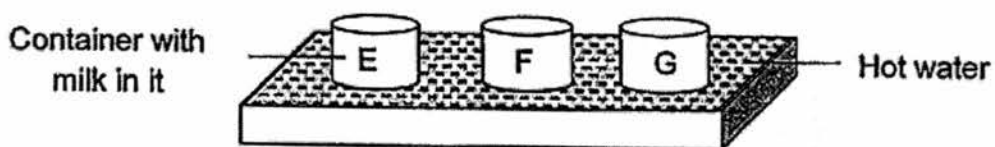

The graph below shows the temperature change of the milk over time.

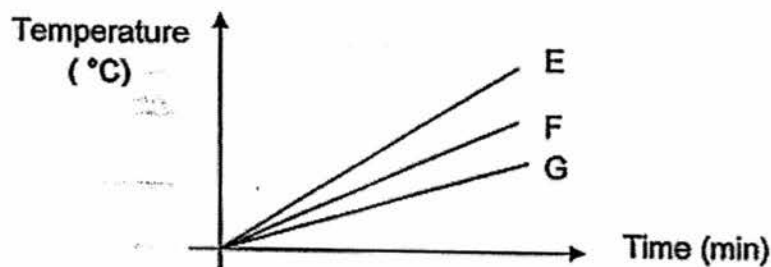

Kelly wanted to keep the drumsticks she baked as warm as possible in a container before dinner.

Based on the graph above, which material, E, F or G, should Kelly choose for her container? Explain. (2m)

44. a) Danny wanted to find out which material is most suitable for making a solid swimming float for a baby. He used 4 items made of materials A, B, C and D respectively. Each item is described in the table below.

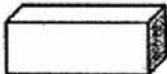
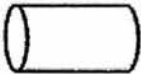
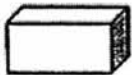
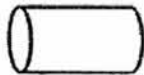
Material	Shape	Colour	Volume
A		Blue	300 cm ³
B		Pink	250 cm ³
C		White	180 cm ³
D		Blue	250 cm ³

- i) Which 2 materials should Danny use to conduct a fair test? (1m)

- ii) Which variable shown in the table does not affect the results of the experiment? (1m)

- b) Jenny bought an inflatable float which needs air to pumped into it.

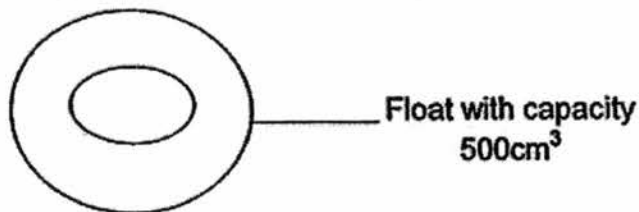

The capacity of the float is 500cm³. Danny pumped 800cm³ of air into the float but the float did not burst. What does this show about the property of gas? (1m)

End of Booklet B

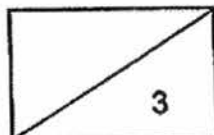

EXAM PAPER 2016

SCHOOL : SCGS

SUBJECT : SCIENCE

TERM : SA2

Q1	Q2	Q3	Q4	Q5	Q6	Q7	Q8	Q9	Q10
3	2	3	3	2	4	4	1	2	2
Q11	Q12	Q13	Q14	Q15	Q16	Q17	Q18	Q19	Q20
4	3	4	3	1	4	1	3	4	4
Q21	Q22	Q23	Q24	Q25	Q26	Q27	Q28	Q29	Q30
1	1	2	1	4	3	2	1	1	2

	Answers
31a	A, C
31b	C, D
31c	Ans: A, B Reason: A and B are plants which undergo photosynthesis which takes in carbon dioxide. And carbon dioxide contributes/ increases/ causes to global warming.
32a	When there are fewer Organism C, Organism D has <u>less competition</u> for the <u>same</u> food source.
32b	Organism B <u>eats A's fruit and passes out the non-digestible seeds</u> as it travels <u>away/ moves further/away from the parent plant</u> . (‘Away from the parent plant’ is needed as that shows dispersal)
33a	i) Seashore : R ii) Rotting Log : Q
33b	The grasshoppers will migrate/ move to a more suitable habitat
34a	<p>The diagram shows a circuit with a battery labeled 'M' at the bottom. The circuit branches into a parallel section containing three components: a resistor labeled 'K', a lamp labeled 'A', and another lamp labeled 'B'. After the parallel section, the circuit continues through a single resistor labeled 'C' before returning to the battery.</p>
34b	Living Room
35a	Shape A is pointed/streamlined/sharpest and it will be able to go deeper into the mud.
35b	<u>Advantage:</u> The seeds germinate on the parent plant have less chance of being swept away where there is no air, warmth and water to germinate.

	OR: The seeds are not able to germinate well in saltish water and will die if they drop into the water for germination. <u>Disadvantage:</u> When the seeds grow under the parent plant, there will be overcrowding in the long run OR: The young plants will compete with the parent plant for sunlight/ nutrients/ space.
36a	227g
36b	The temperature of the water vapour in Room B is not as warm as in Room A/ cooler than in Room A, thus the rate of condensation in Room B is slower and fewer water droplets are produced for Can B
37	Z has the most streamlined shape. Therefore/ thus it can reduce water resistance/ frictional force most to travel fastest.
38a	Electrical energy from mains → heat energy in the metal coil → heat energy in the hot water
38	(Slow down) The thicker pipe will cause the heating of water to slow down because the heat from the coils has to pass through more material/ travel through a longer distance to reach the hot water.
bi	Ans: (Speed Up) With more coiling/ coils, there is more heated/ hot coils around the pipe, this increases the amount of heat transferred to the water/ pipe.
bii	OR (Speed Up) With more coiling/ coils, there is more heat produced by the coils, thus more heat will be transferred to the water.
39a	When the number of cars (in Country W) increases, the number/ population of organism R decreases
39b	When there are more factories, they produce more air pollutants (which may be acidic)/ acidic gases AND

	Air pollutants / acidic gases will dissolve in/ mix with the clouds/ rain water, causing the rain to become <u>more</u> acidic.	
40		Description
	a)	It is a magnetic material.
	b)	It is definitely not a magnet
	c)	It is definitely a magnet
	d)	Not possible to tell if it is a
	Rod/s	A, B, C B C A
41a	Both the young do not resemble/ do not look like the parent.	
41b	<p><not sharing the same food source and similarly suffering from lack of food if food source is depleted/ diseased etc> If the adult and the young have different habitats/ live in different places, they will likely have different food sources. So even if place the adult is in has no food, the young is at another place and may have food and survives.</p> <p>OR</p> <p><not having the same predators and suffering similarly from a sudden increase in predators> If the adult and the young live in different places, they are likely to have different types of predators. So, if there is a sudden increase in predators for one/ the young/ the adult, eating up all the young/ adult up, the other / adult/ young can still survive.</p> <p>OR</p> <p><not having the same habitat and suffering similarly pollution or poisoning> If where the adults live gets polluted and kill / poison them, the place the young live may still be safe enough for the young to survive. (and vice versa)</p>	
42a	The kinetic energy of the first block is transferred to the next block, which will transfer the energy to the following block (from one block to another) right to the last block.	
42b	Sound (energy) and Heat (energy)	

42c	The blocks after the gap will not fall as the energy cannot be transferred to the next block/ the next block is too far away for the block before X to touch/ hit/ reach.
42d	The Styrofoam blocks have a much smaller mass/ are lighter than the metal blocks, thus they do not have enough kinetic energy to topple over the heavier metal block.
43a	The drumstick in oven B has greater contact area/ exposure with the heat/ to the hot air so there is more heat conduction to the drumstick, thus they cook faster.
43b	G, G is the poorest conductor of heat and heat from the drumstick will travel to the surroundings the slowest/ drumstick will lose heat the slowest through the poorest conductor of heat.
44ai	B and D
44aii	Colour has no impact on/ does not affect the results.
44bi	<p>Air can be compressed.</p> <p>OR</p> <p>Air has no definite volume.</p>