



HENRY PARK PRIMARY SCHOOL
2019 SA1
MATHEMATICS
PRIMARY 6

PAPER 1
(BOOKLET A)

Name: _____ ()

Parent's Signature

Class: Primary 6 _____ / 6M _____

Marks:

Paper 1	Booklet A	20
	Booklet B	25
Paper 2		55
Total		100

Total Time for Booklets A and B: 1 hour

Do not turn over this page until you are told to do so.

Follow all instructions carefully.

Answer all questions.

Shade your answers in the Optical Answer Sheet (OAS) provided.

You are not allowed to use a calculator.

Questions 1 to 10 carry 1 mark each. Questions 11 to 15 carry 2 marks each.
For each question, four options are given. One of them is the correct answer.
Make your choice (1, 2, 3 or 4) and shade your answer on the Optical Answer Sheet.
(20 marks)

1 What is the value of $10 \div 400$?

- (1) 0.25
- (2) 0.025
- (3) 40
- (4) 4

2 Arrange the following fractions from the smallest to the greatest

	<u>smallest</u>		<u>greatest</u>
(1)	$\frac{6}{5}$	$\frac{7}{6}$	$1\frac{1}{4}$
(2)	$\frac{7}{6}$	$\frac{6}{5}$	$1\frac{1}{4}$
(3)	$\frac{7}{6}$	$1\frac{1}{4}$	$\frac{6}{5}$
(4)	$1\frac{1}{4}$	$\frac{7}{6}$	$\frac{6}{5}$

(Go on to the next page)

- 3 In the scale below, what is the value of the reading at X?

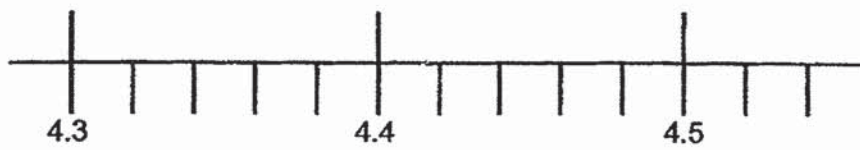

- (1) 4.52
(2) 4.54
(3) 4.7
(4) 4.9
- 4 Find the value of $14 - 2 \times 4 + 20 \div 4$

- (1) 11
(2) 17
(3) 53
(4) 72

- 5 There is a total of 60 red and green beans in a container. 36 of them are red beans. What is the ratio of the number of green beads to the number of red beads in the container?

- (1) 2 : 3
(2) 2 : 5
(3) 3 : 2
(4) 3 : 5

(Go on to the next page)

- 6 The opening hours of Siti's Cafe are shown below.
How long is the cafe open each day?

- (1) 8 h 15 min
- (2) 8 h 45 min
- (3) 9 h 15 min
- (4) 9 h 45 min



- 7 The figure below is made up of square ABCD and rectangle EFGC.
What is the perimeter of the figure?

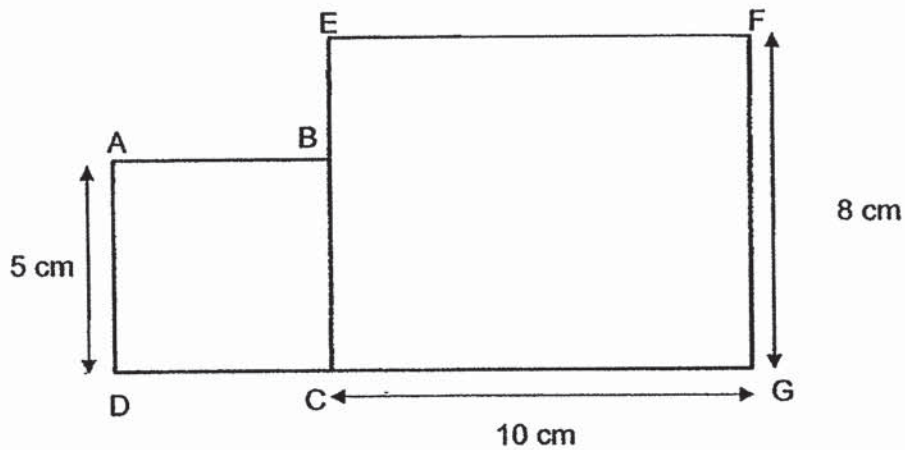

- (1) 43 cm
- (2) 46 cm
- (3) 51 cm
- (4) 105 cm

(Go on to the next page)

8 A solid cuboid of height 7 cm has a square base of side 5 cm. What is its volume?

- (1) 25 cm³
- (2) 35 cm³
- (3) 175 cm³
- (4) 245 cm³

9 In the figure, ACE and BCD are straight lines. Find $\angle ABC$.

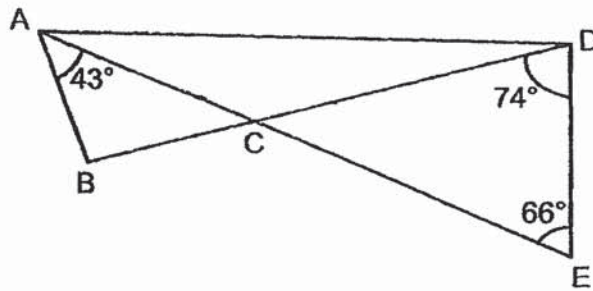

- (1) 40°
- (2) 74°
- (3) 94°
- (4) 97°

(Go on to the next page)

- 10 The graph below shows the number of cakes sold in each month from May to September.

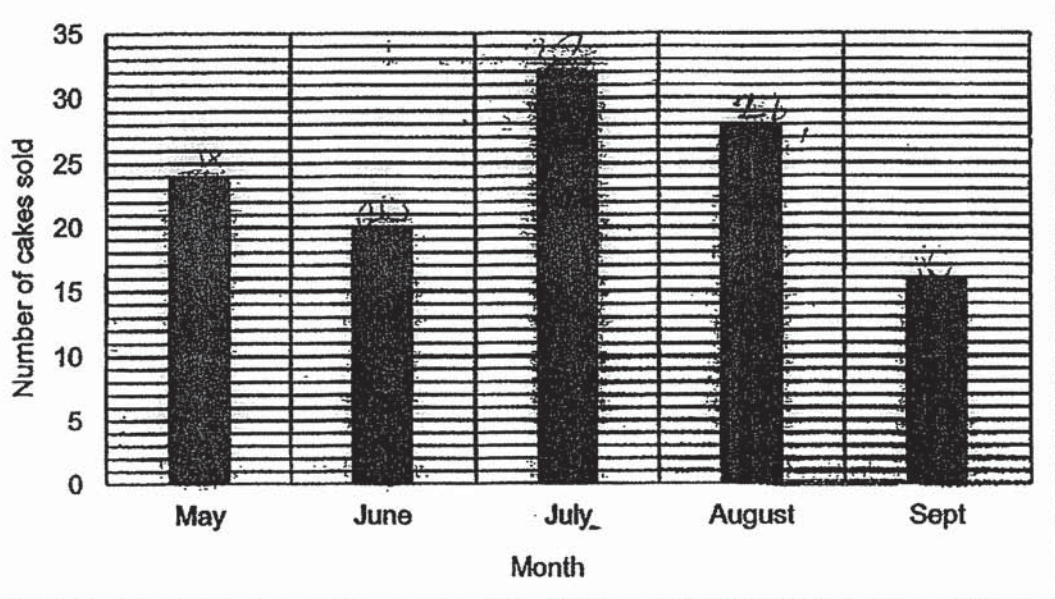

What is the average number of cakes sold in each month from May to September?

- (1) 16
- (2) 20
- (3) 24
- (4) 40

(Go on to the next page)

11 The top view of a solid is drawn in a square grid.

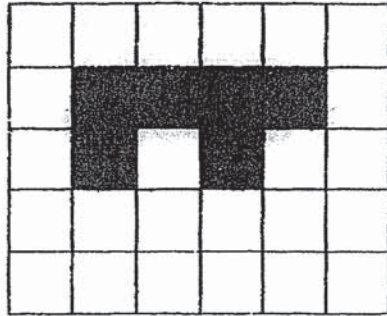

Which of the following is the solid with the top view drawn above?

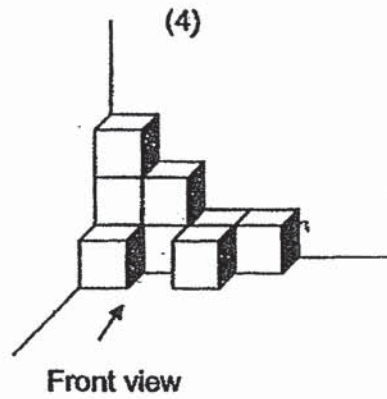
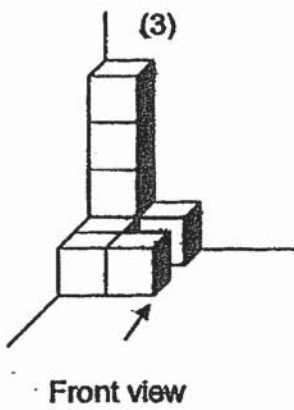
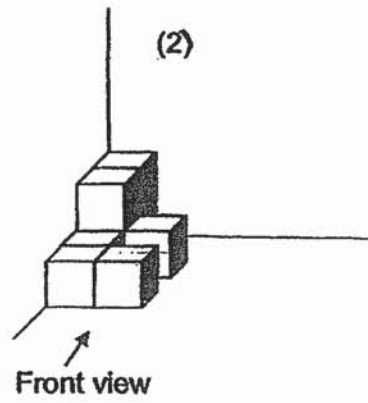
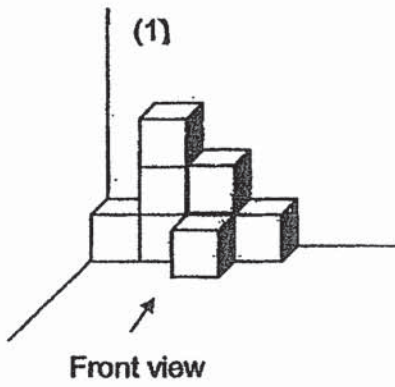

(Go on to the next page)

- 12 Janelle used stickers of four different shapes to make a pattern. The first 15 stickers are shown below. What was the shape of the 100th sticker?



- (1) ☺
- (2) 📖
- (3) ☀
- (4) ❤

- 13 Dave has three identical right-angled triangles. He joined them to form the figure ABCD shown below. The area of figure ABCD is 72 cm². AB = 12 cm and BC is 10 cm. Find the perimeter of the figure ABCD.

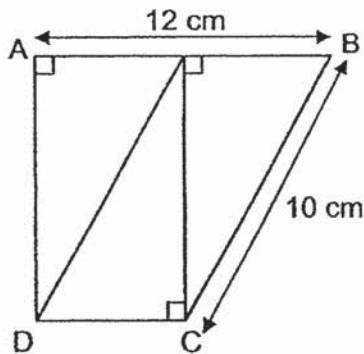

- (1) 34 cm
- (2) 36 cm
- (3) 38 cm
- (4) 40 cm

(Go on to the next page)

- 14 In a chess competition, a player has to play three games in Round 1. If the average score in Round 1 is at least 35, the player will be able to move on to Round 2.

The table below shows Lydia's scores for the two games she played in Round 1.

Round 1	
Game	Score
1 st	32
2 nd	28
3 rd	?

What is the lowest score she must get in the 3rd game of Round 1 in order to move on to Round 2?

- (1) 34
- (2) 45
- (3) 60
- (4) 70

(Go on to the next page)

15 Isaac used $\frac{3}{5}$ of his money to buy 6 spring rolls and 8 chicken wings.

The cost of 3 spring rolls was the same as the cost of 2 chicken wings.

What is the most number of such spring rolls he could buy with $\frac{1}{4}$ of his remaining money?

- (1) 8
- (2) 2
- (3) 3
- (4) 12

(Go on to Booklet B)



HENRY PARK PRIMARY SCHOOL
2019 SA1
MATHEMATICS
PRIMARY 6

PAPER 1
(BOOKLET B)

Name: _____ ()

Class: Primary 6 _____ / 6M _____

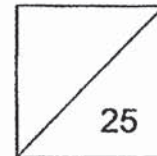

Total Time for Booklets A and B: 1 hour

Do not turn over this page until you are told to do so.

Follow all instructions carefully.

Answer all questions.

Write your answers in this booklet.

You are **not** allowed to use a calculator.

Questions 16 to 20 carry 1 mark each. Write your answers in the spaces provided.
For questions which require units, give your answers in the units stated.

(5 marks)

Do not write
in this space

16 Express 8.08 as a mixed number in the simplest form.

Ans: _____

17 Use all the digits 1, 8, 4 and 5 to form the whole number closest to 5000.

Ans: _____

(Go on to the next page)

Do not write
in this space

- 18 The figure below shows some shaded squares. Shade 2 more squares to form a symmetric figure with AB as the line of symmetry.

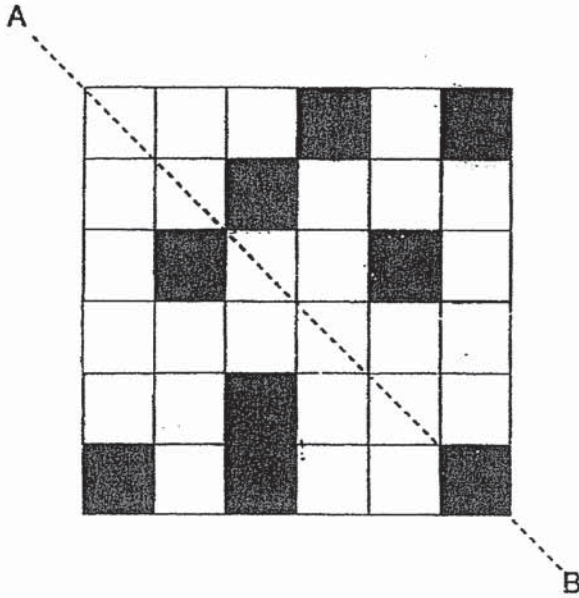

- 19 Helen played on her piano from 11.45 a.m to 1.25 p.m. How long did she play on her piano? Give your answer in minutes.

Ans: _____ min

(Go on to the next page)

20

The shaded figure is a semicircle of diameter 20 cm. What is the area of the shaded figure? (Take $\pi = 3.14$)

Do not write in this space

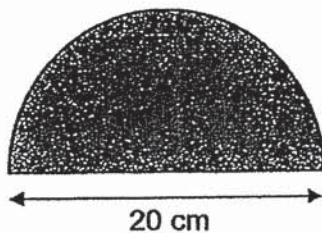

Ans: _____ cm²

(Go on to the next page)

Questions 21 to 30 carry 2 marks each. Show your working clearly and write your answers in the spaces provided. For questions which require units, give your answers in the units stated.

Do not write in this space

(20 marks)

- 21 The figure shows a cubical tank which is $\frac{3}{5}$ -filled with water.

What is the volume of water needed to fill up the tank to the brim?

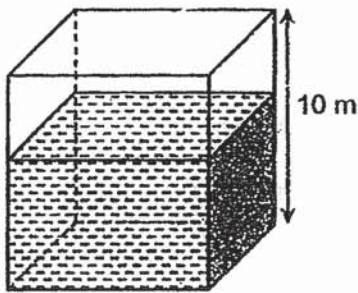

Ans: _____ m³

- 22 Jerome had 51 stickers and Cayden had 37 stickers.
After both boys used the same number of stickers, the number of stickers Jerome and Cayden had were in the ratio 5 : 3.
How many stickers did Cayden have in the end?

Ans: _____

(Go on to the next page)

- 23 Rebecca had 4 times as many apples as pears at first. She gave away 16 apples and bought 15 pears. In the end, she had 8 more apples than pears. How many pears did she have at first?

Do not write
in this space

Ans: _____

- 24 The figure below is made up of a square and two quarter circles. Find the perimeter of the figure. (Take $\pi = \frac{22}{7}$)

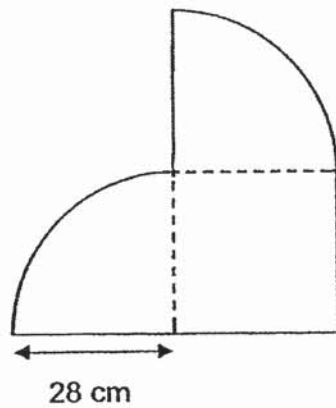

Ans: _____ cm

(Go on to the next page)

25 David, Leon and Felix had some stickers. After David gave $\frac{3}{8}$ of his stickers to Leon and $\frac{3}{10}$ of his remaining stickers to Felix, all three boys had the same number of stickers in the end. What was the ratio of the number of stickers Leon had at first to the number of stickers Felix had at first?

Do not write
in this space

Ans: _____

26 A piece of rope measuring 10.7 m in length was cut into three pieces. The first piece was 1.2 m longer than the second piece. The first piece was three times as long as the third piece. What was the length of the shortest piece in metres?

Ans: _____ m

(Go on to the next page)

- 27 The diameter of the circle shown below is 16 cm. Find the area of the shaded square.

Do not write
in this space

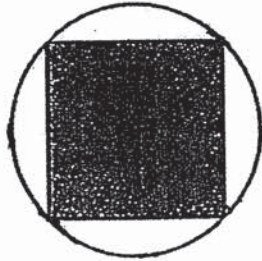

Ans: _____ cm²

- 28 ABCD is a trapezium. AD = AB and $\angle DAB = 124^\circ$. Find $\angle BDC$.

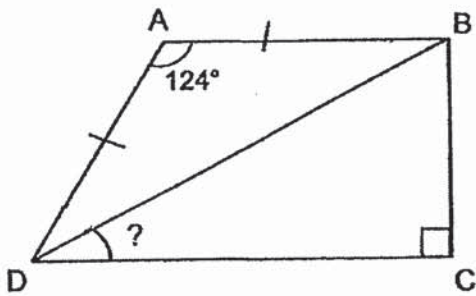

Ans: _____ °

(Go on to the next page)

- 29 An Xin baked a cake and gave $\frac{1}{5}$ of it to her friend. She cut the remaining cake equally into 12 slices. What fraction of the whole cake was each slice? Express your answer in the simplest form.

Do not write
in this space

Ans: _____

- 30 A publisher sold 1000 magazines in March. The number of magazines sold in April was a 20% increase from what was sold in March. The number of magazines sold in May was a 30% decrease from what was sold in April. How many magazines did the publisher sell in May?

Ans: _____

End of Paper 1

Page 8



HENRY PARK PRIMARY SCHOOL
2019 SA1
MATHEMATICS
PRIMARY 6

PAPER 2

Name: _____ ()

Class: Primary 6 _____ / 6M _____

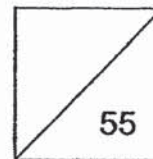

Time for Paper 2: 1 h 30 min

Do not turn over this page until you are told to do so.

Follow all instructions carefully.

Answer all questions.

Show your working clearly as marks are awarded for correct working.

Write your answers in this booklet.

You are allowed to use a calculator.

Questions 1 to 5 carry 2 marks each. Show your working clearly and write your answers in the spaces provided. For questions which require units, give your answers in the units stated.

(10 marks)

Do not
write in
this
space

1 Dylan has a number of red green and blue balloons $\frac{5}{12}$ of the balloons are red.

There are twice as many red balloons as green balloons. What fraction of the

balloons is blue? Express your answer in the simplest form.

Ans: _____

(Go on to the next page)

2 The solid below was made up of 11 unit cubes.

Do not write in this space

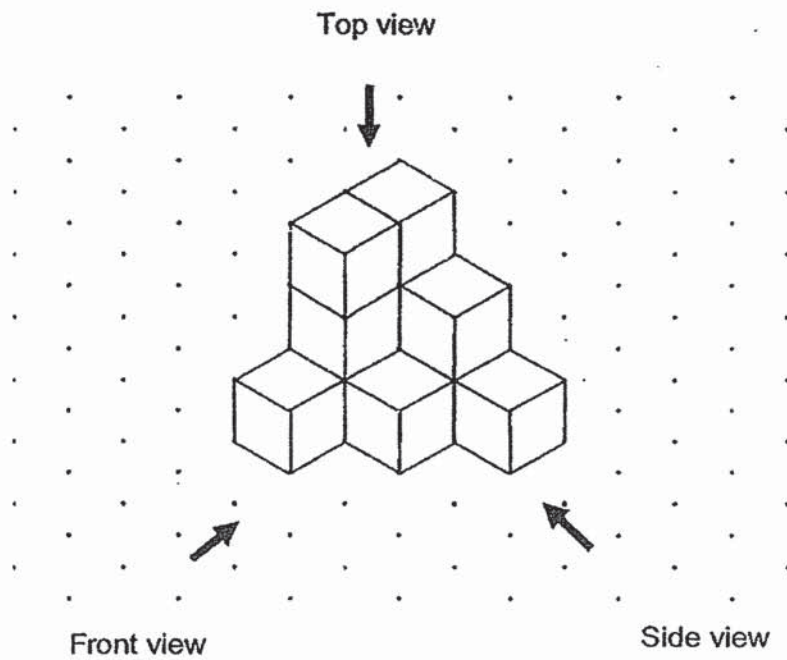

Draw the front view and the side view of the solid in the square grids below.

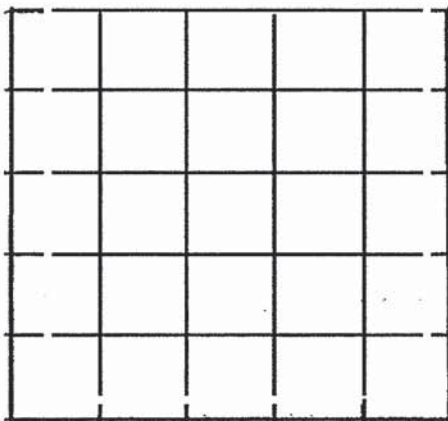

Front view

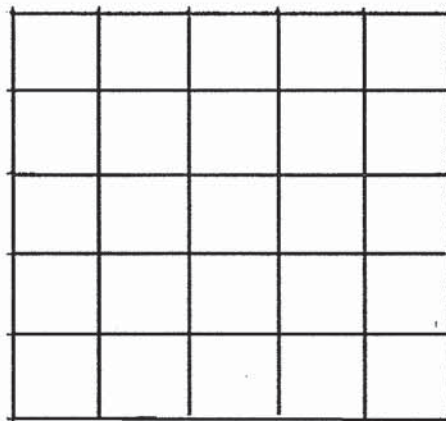

Side view

(Go on to the next page)

3 In the square grid below, EF and FG are straight lines.

(a) Measure and write down the size of $\angle EFG$.

(b) EF and FG form two sides of a rhombus EFGH.
Complete the drawing of rhombus EFGH in the square grid.

Do not
write in
this
space

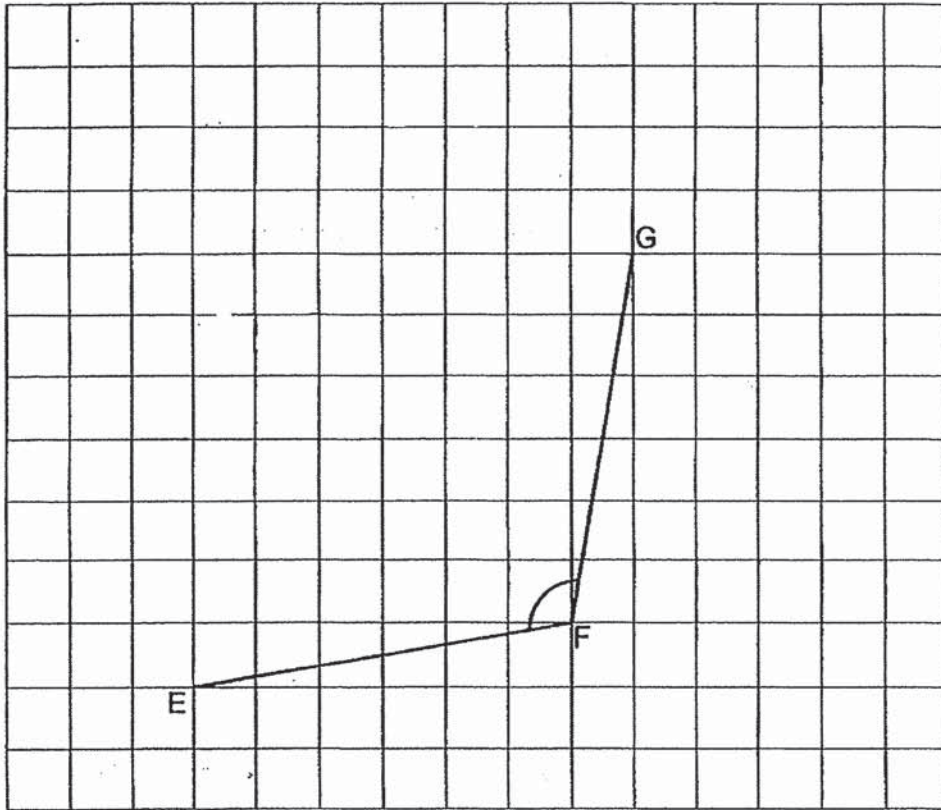

Ans : (a) _____°

(Go on to the next page)

- 4 A number of students took part in a race. The table shows the number of students with the time taken to complete the race.

Do not
write in
this
space

Time taken to complete the race	Number of students
More than 14 seconds	4
13.1 to 13.9 seconds	9
12.3 to 13 seconds	12
11.6 to 12.2 seconds	8
11 to 11.5 seconds	5
Less than 11 seconds	2

Prizes were given to $\frac{3}{8}$ of the students who completed the race faster than the rest. Ann was one of the prize winners. What was the longest time she could have taken to complete the race?

Ans: _____ seconds

- 5 At first, Jareth had 80 marbles and some erasers. After he gave away 12 marbles and 25% of his erasers, he had a total of 128 marbles and erasers left. How many erasers did Jareth give away?

Ans: _____

(Go on to the next page)

For questions 6 to 17, show your working clearly and write your answers in the spaces provided. The number of marks available is shown in brackets [] at the end of each question and part-question.

(45 marks)

Do not
write in
this
space

- 6 Christopher had \$96 more than Hong Wei at first. Hong Wei then gave Christopher \$36. In the end, Christopher had 4 times as much money as Hong Wei. How much money did Christopher have at first?

Ans: _____ [3]

(Go on to the next page)

- 7 60% of the Chess Club members are girls. $\frac{4}{5}$ of the girls and $\frac{3}{4}$ of the boys wear spectacles. What percentage of the Chess Club members wear spectacles?

Do not write in this space

Ans: _____ [3]

(Go on to the next page)

8 The figure below is made up of two isosceles triangles. Find $\angle y$

Do not
write in
this
space

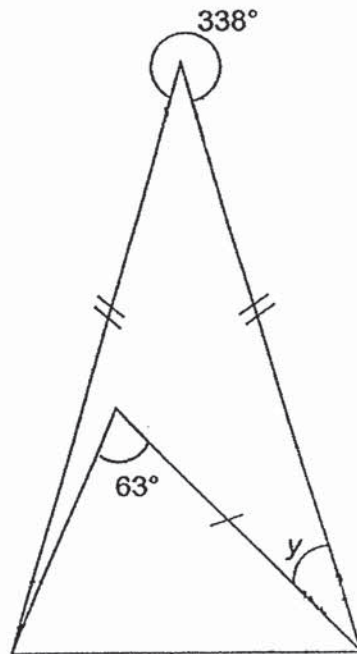

Ans: _____ [3]

(Go on to the next page)

9 The graph below shows the number of visitors at a museum from January to April.

Do not
write in
this
space

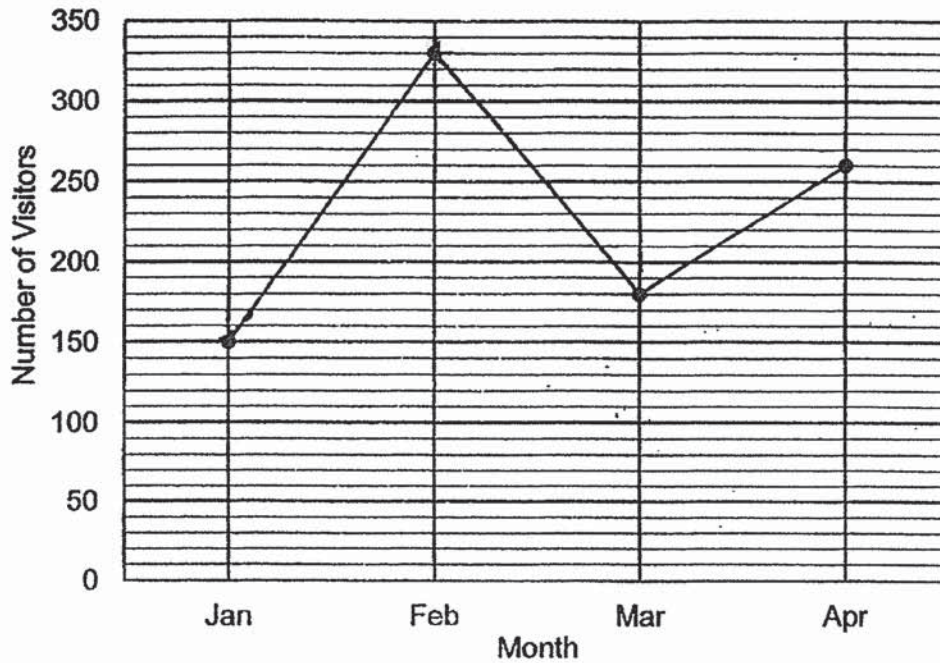

- (a) How many more visitors went to the museum in February than in March?
- (b) What was the percentage increase in the number of visitors at the museum in April compared to January?(Round your answer to one decimal place)

Ans: (a) _____ [1]

(b) _____ [2]

(Go on to the next page)

- 10 Jiajia had $(19a + 3)$ stamps. Kathy had $8a$ fewer stamps than Jiajia. Bernice had $(3a - 2)$ more stamps than Kathy. Given that the three girls had a total of 1151 stamps, how many stamps did Jia Jia have?

Do not
write in
this
space

Ans: _____ [4]

(Go on to the next page)

11 Eydin has two strips of stickers, A and B, of equal length. The length of each sticker is 1.2 cm. The stickers in each strip form a repeated pattern as shown below.

Do not write in this space

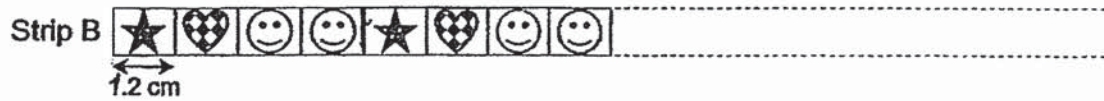

There are 56 heart stickers () altogether in both strips of stickers. What is the length of each strip of stickers?

Ans: _____ [3]

(Go on to the next page)

- 12 The figure shows 6 identical squares. The area of each square is 169 cm^2 . The outline of the shaded parts of the figure is formed by a quarter circle and straight lines. Find the area of the shaded parts.
(Take $\pi = 3.14$)

Do not write in this space

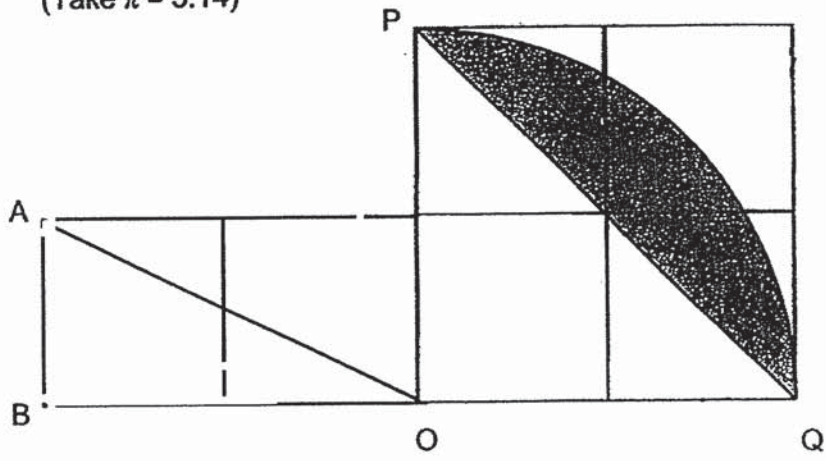

Ans: _____ [3]

(Go on to the next page)

- 13 Kenji wants to buy a bicycle. The table shows the prices of the bicycle from two different shops.

Shop A		Shop B	
Original Price	% Discount	Original Price	% Discount
\$ 1040	30%	\$1175	35%

Do not
write in
this
space

- (a) What is the difference in the discounted price between the two shops?
- (b) GST is 7% of the discounted price of the bicycle. How much does Kenji have to pay for the bicycle in Shop A including GST?

Ans: (a) _____ [2]

(b) _____ [2]

(Go on to the next page)

Do not write in this space

14 A rectangular tank, with a capacity of 60 litres, was partly filled with water at first. Tap A was turned on to add more water into the tank. After 10 minutes, Tap A was turned off and Tap B was turned on to drain water out of the tank until the 30th minute. The line graph shows the volume of water in the tank over the period of 30 minutes.

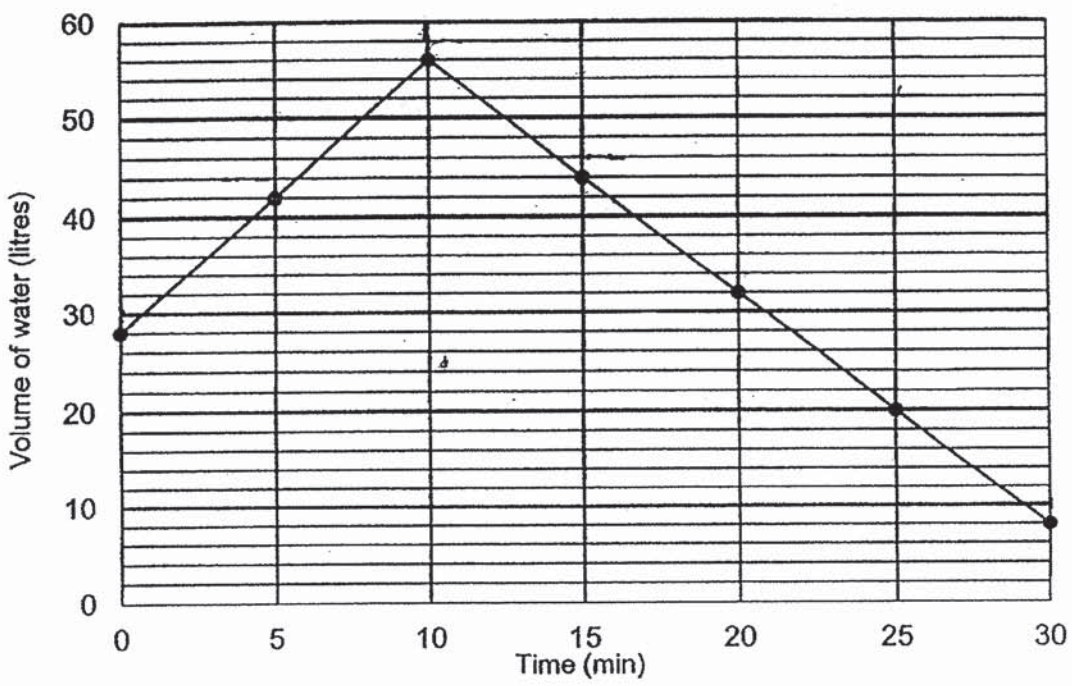

(a) How many litres of water flowed into the tank in 1 min when Tap A was turned on?

Ans: _____ [2]

(b) Each statement below is either true, false or not possible to tell from the information given. For each statement, put a tick (✓) in the correct column. [2]

Statement	True	False	Not possible to tell
At the 15 th minute, there was 45 litres of water in the tank.			
From the 10 th minute until the 30 th minute, water was draining at 2.4 litres per minute.			
If both Tap A and Tap B were turned on at the 30 th minute, the volume of water in the tank will remain the same.			

(Go on to the next page)

15 Marika baked a total of 945 chocolate and vanilla buns. After selling an equal number of both types of buns, she had $\frac{1}{3}$ of the chocolate buns and $\frac{1}{6}$ of the vanilla buns left. She packed the remaining chocolate buns into 23 boxes. Some boxes contained 5 chocolate buns while the rest contained 9 chocolate buns.

- (a) How many chocolate buns were packed into the 23 boxes?
(b) How many boxes contained 9 chocolate buns?

Do not
write in
this
space

Ans: (a) _____ [3]

(b) _____ [2]

(Go on to the next page)

16 The figure below shows a 3 m wide flower garden. The outline of the flower garden is formed using 2 identical large semicircles, 2 identical small semicircles and 2 straight lines.

Do not write in this space

(a) Find the perimeter of the flower garden.

(b) Find the area of the flower garden.

(Take $\pi = 3.14$)

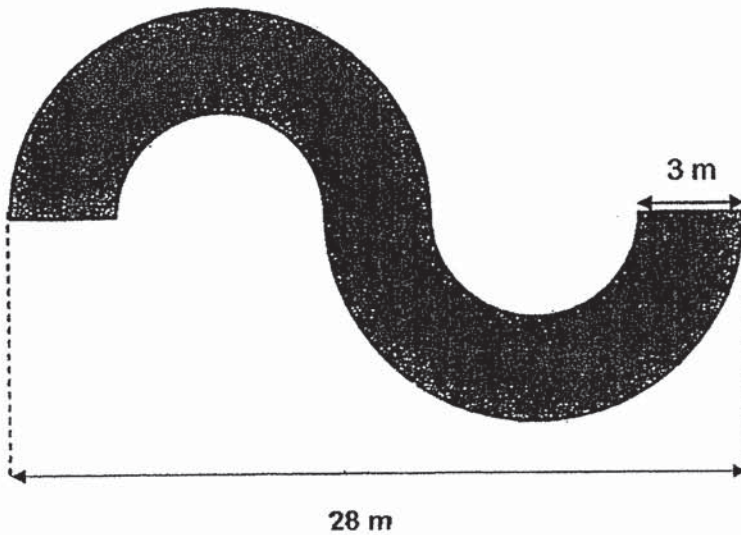

Ans: (a) _____ [3]

(b) _____ [2]

(Go on to the next page)

17 In the figure, ABCD is a parallelogram. Triangles DEG, ECG and DGC make up the equilateral triangle DEC. $\angle EDG = 35^\circ$, $\angle ECG = 40^\circ$ and $\angle EGC = 106^\circ$. FEC is a straight line and $\angle ABC = 73^\circ$

(a) Find $\angle AFE$

(b) Find $\angle DGE$

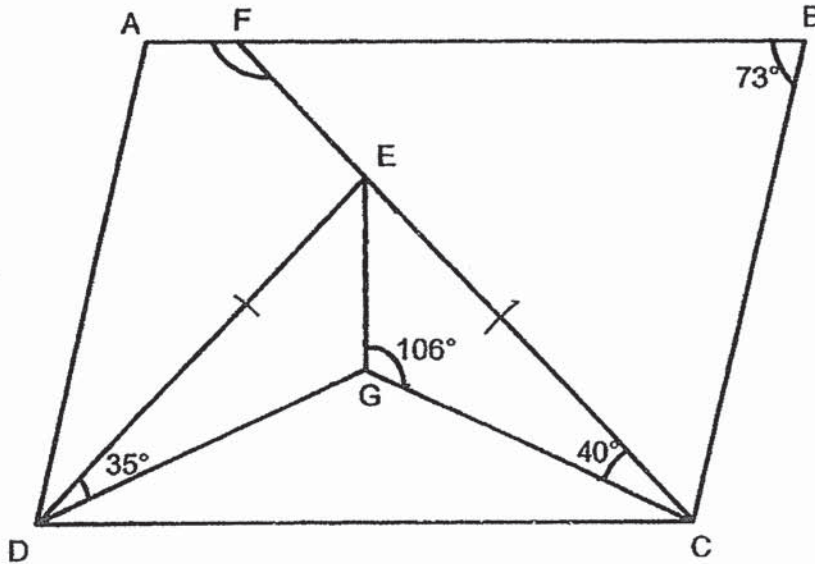

Do not write in this space

Ans: (a) _____ [2]

(b) _____ [3]

End of Paper 2

Setters: Mrs Elaine Chua, Mr Jenfry Tseng, Mrs Ling Lee Ching

Page 16

SCHOOL : HENRY PARK PRIMARY SCHOOL
 LEVEL : PRIMARY 6
 SUBJECT : MATH
 TERM : 2019 SA1

PAPER 1 BOOKLET A

Q 1	Q2	Q3	Q4	Q5	Q6	Q7	Q8	Q9	Q10
2	2	2	1	1	3	2	3	4	3

Q 11	Q12	Q13	Q14	Q15
4	1	2	2	3

PAPER 1 BOOKLET B

Q16)	$8\frac{2}{25}$
Q17)	5148
Q18)	
Q19)	11.45am to 1.25pm = 1h 40min = 100 min
Q20)	$\frac{1}{2} \times 3.14 \times 10^2 = \frac{1}{2} \times 3.14 \times 100$ $= 31.4 \times 5 = 157\text{cm}^2$
Q21)	$10\text{m} \times 10\text{m} \times 10\text{m} = 1000\text{m}^3$ $\frac{2}{5} \times 1000\text{m}^3 = 400\text{m}^3$

Q22)	21
Q23)	$16 + 15 + 8 = 39$ $39 \div 3 = 13$ pears
Q24)	$\frac{1}{2} \times \frac{22}{7} \times 56 = 88$ $28 \times 4 = 112$ $112 + 88 = 200$ cm
Q25)	1 : 4
Q26)	$10.7 - 1.6\text{m} = 9.1\text{m}$ $9.1\text{m} \div \frac{7}{3} = 9.1 \times \frac{3}{7} = 3.9$ $\frac{1}{3} \times 3.9 = 1.3$ $1.3 + 0.4 = 1.7$ m
Q27)	$2 \times \frac{1}{2} \times 16 \times 8 = 128$ cm ²
Q28)	$180^\circ - 124^\circ = 56^\circ$ $56^\circ \div 2 = 28^\circ$ $90^\circ - 28^\circ = 62^\circ$ $180^\circ - 90^\circ - 62^\circ = 28^\circ$
Q29)	$3 \times 5 = 15$ $= \frac{1}{15}$
Q30)	March \rightarrow 1000 April $\rightarrow \frac{120}{100} \times 1000 = 1200$ May $\rightarrow \frac{70}{100} \times 1200 = 840$ magazines

PAPER 2

Q1)	$24u - 15u = 9u$ $\frac{9}{24} = \frac{3}{8}$
-----	--

Q2)

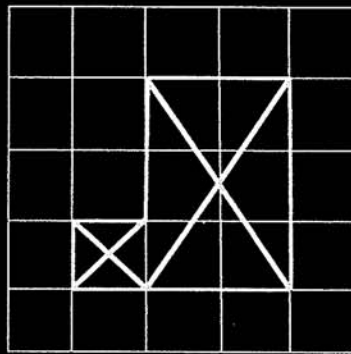
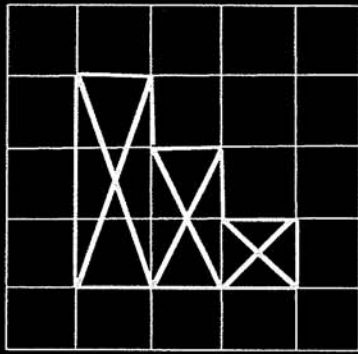

Q3)

a) 110°

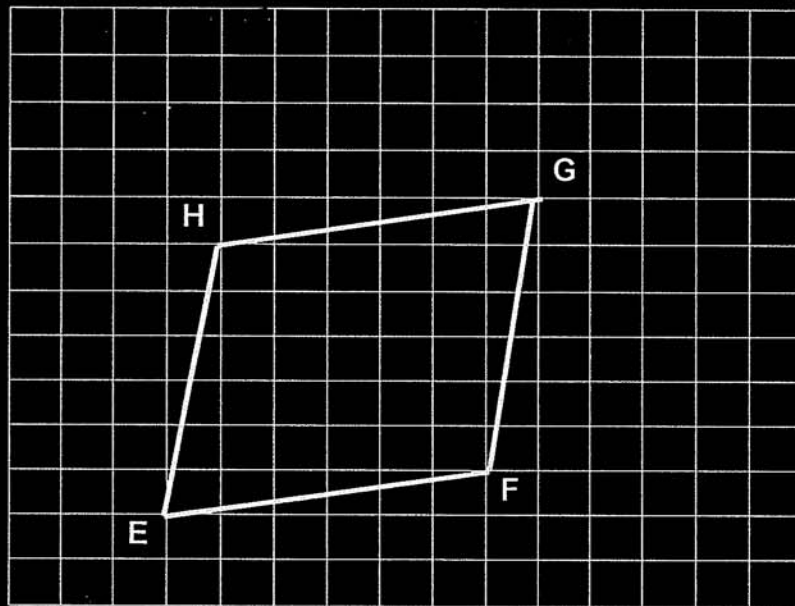

Q4)

$$4 + 9 + 12 + 8 + 5 + 2 = 40$$

$$\frac{3}{8} \times 40 = 15$$

ANS: 12.2

Q5)

$$68 + \frac{3}{4}n = 128$$

$$\frac{3}{4}n = 128 - 68 = 60$$

$$n = \frac{60 \times 4}{3}$$

$$= 80$$

$$\frac{1}{4} \times 80 = 20 \text{ erasers}$$

Q6)	$U + 132 = 4u - \$144$ $\$132 + \$144 = 4u - u$ $\$276 = 3u$ $U = \$276 \div 3 = \92 $\$92 + \$96 = \$188$
Q7)	$48\% + 30\% = 78\%$
Q8)	$360^\circ - 338^\circ = 22^\circ$ $(180^\circ - 22^\circ) \div 2 = 79^\circ$ $180^\circ - 63^\circ - 63^\circ = 54^\circ$ $79^\circ - 54^\circ - 25^\circ$
Q9)	<p>a) $330 - 180 = 150$ visitors</p> <p>b) $260 - 150 = 110$</p> $\frac{110}{150} \times 100\% \approx 73.3\%$
Q10)	<p>Jia $\rightarrow 19a + 3$</p> <p>Kathy $\rightarrow 11a + 3$</p> <p>B $\rightarrow 14a + 1$</p> $19a + 11a + 14a + 7 = 1151$ $44a = 1151 - 7 = 1144$ $a = \frac{1144}{44} = 26$ $19a = 26 \times 19 = 494$ $494 + 3 = 497 \text{ stamp}$
Q11)	<p>Given that there are 56</p> <p>Stickers B = $56 \div 7 = 8$</p> <p>Length of the strip of stickers = $8 \times 12 \times 1.2 = 115.2 \text{ cm}$</p>
Q12)	<p>Area of triangle = $\frac{1}{2} \times 26 \times 26 = 338$</p> <p>Area of quarter circle = $\frac{1}{4} \times 3.14 \times 26 = 530.66$</p> <p>Area of square = $26 \times 26 = 676$</p> <p>Area of A = $676 - 530.66 = 145.34$</p> <p>Area of B = $676 - 338 - 145.34 = 192.66$</p> <p>Area of C = $\frac{1}{2} \times 26 \times 13 = 169$</p> $192.66 + 169 = 361.66 \text{ cm}^2$
Q13)	<p>a) Shop A $\rightarrow \frac{70}{100} \times 1040 = 728$</p> <p>Shop B $\rightarrow \frac{65}{100} \times 1175 = 763.75$</p> $763.75 - 728 = \$35.75$

	<p>b) $\frac{107}{100} \times 728 = \\778.96</p>									
Q14)	<p>a) $56 - 28 = 28$ $\frac{28}{10} = 2.8L$</p> <p>b)</p> <table border="1" style="margin-left: auto; margin-right: auto;"> <tr> <td></td> <td style="text-align: center;">✓</td> <td></td> </tr> <tr> <td style="text-align: center;">✓</td> <td></td> <td></td> </tr> <tr> <td></td> <td style="text-align: center;">✓</td> <td></td> </tr> </table>		✓		✓				✓	
	✓									
✓										
	✓									
Q15)	<p>a) $7.5p + 6p = 13.5p$ $13.5p = 945$ $p = \frac{945}{13.5} = 70$ $70 \times 2.5 = 175$</p> <p>b) $23 \times 5 = 115$ $175 - 115 = 60$ $\frac{60}{4} = 15$ (9 boxes) $23 - 15 = 8$ (3 boxes) ANS : 15 boxes</p>									
Q16)	<p>a) $28 - 3 - 3 - 3 = 19$ $19 \div 2 = 9.5$ $3.14 \times 9.5 = 29.83$ $29.83 + 48.67 + 3 + 3 = 84.5m$</p> <p>b) $3.14 \times 7.75^2 = 188.59625$ $3.14 \times 4.75^2 = 70.84625$ $188.59625 - 70.84625 = 117.75m^2$</p>									
Q17)	<p>a) $60^\circ - 40^\circ = 20^\circ$ $180^\circ - 40^\circ - 20^\circ = 120^\circ$</p> <p>b) $60^\circ - 35^\circ = 25^\circ$ $180^\circ - 25^\circ - 20^\circ = 135^\circ$ $360^\circ - 135^\circ - 106^\circ = 119^\circ$</p>									