

PSLE  
Index No



MARIS STELLA HIGH SCHOOL (PRIMARY)  
PRELIMINARY EXAMINATION  
PRIMARY 6 MATHEMATICS  
18 AUGUST 2023  
PAPER 1

(BOOKLET A)

15 questions

20 marks

Total time for Booklets A and B: 1 hour

NAME :

CLASS : PRIMARY 6

**INSTRUCTIONS TO CANDIDATES**

1. DO NOT OPEN THIS BOOKLET UNTIL YOU ARE TOLD TO DO SO.
2. FOLLOW ALL INSTRUCTIONS CAREFULLY.
3. ANSWER ALL QUESTIONS.
4. SHADE YOUR ANSWERS IN THE OPTICAL ANSWER SHEET (OAS) PROVIDED.
5. YOU ARE NOT ALLOWED TO USE A CALCULATOR.

Questions 1 to 10 carry 1 mark each. Questions 11 to 15 carry 2 marks each.  
 For each question, four options are given. One of them is the correct answer.  
 Make your choice (1, 2, 3 or 4) and shade your answer on the Optical Answer Sheet.

(20 marks)

1. Which of the following is seventy-five thousand and thirty in numerals?

- (1) 7530
- (2) 75 030
- (3) 75 300
- (4) 750 030

2. The diagram shows a tablet used in a lesson in the classroom. Which of the following could be the mass of the tablet?

- (1) 8 g
- (2) 8 kg
- (3) 80 kg
- (4) 800 g



3. Arrange these fractions from the smallest to the largest.

$$\frac{4}{5}, \quad \frac{3}{7}, \quad \frac{2}{3}$$

SmallestLargest

- |     |                 |                 |               |
|-----|-----------------|-----------------|---------------|
| (1) | $\frac{2}{3}$ , | $\frac{3}{7}$ , | $\frac{4}{5}$ |
| (2) | $\frac{3}{7}$ , | $\frac{4}{5}$ , | $\frac{2}{3}$ |
| (3) | $\frac{3}{7}$ , | $\frac{2}{3}$ , | $\frac{4}{5}$ |
| (4) | $\frac{4}{5}$ , | $\frac{2}{3}$ , | $\frac{3}{7}$ |

4. Which number is the largest?
- (1) 0.78
  - (2) 0.87
  - (3) 0.708
  - (4) 0.807
5. Express  $3\frac{2}{25}$  as a decimal.
- (1) 3.2
  - (2) 3.8
  - (3) 3.08
  - (4) 3.22
6. Express 3080 cm in m.
- (1) 3.08 m
  - (2) 3.8 m
  - (3) 30.08 m
  - (4) 30.8 m
7. Round 3.465 to 2 decimal places.
- (1) 3.40
  - (2) 3.46
  - (3) 3.47
  - (4) 3.50
8. In a basket, there were 4 apples, 8 pears and 12 papayas. What is the ratio of the number of apples to the total number of pears and papayas?
- (1) 1 : 5
  - (2) 5 : 1
  - (3) 1 : 2
  - (4) 1 : 3

9. Which 2 lines are parallel to each other?

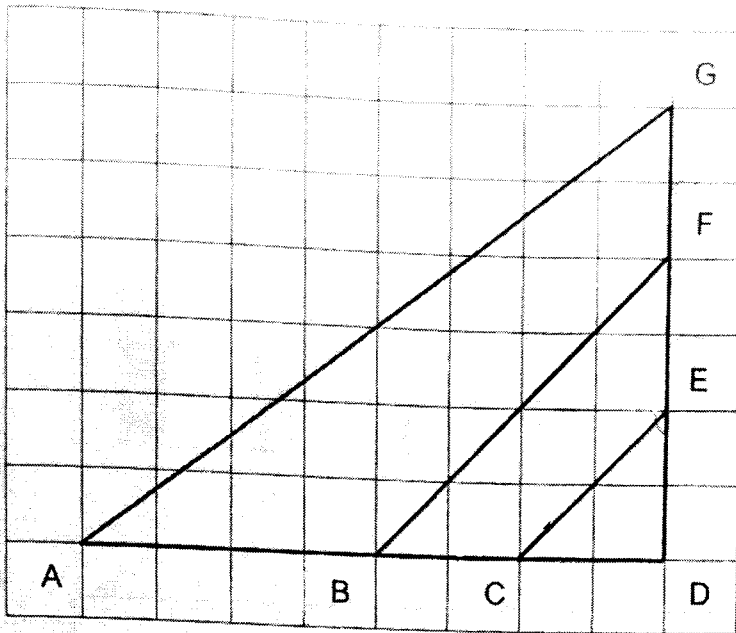

- (1) AD and DG
- (2) AG and BF
- (3) AG and CE
- (4) BF and CE

10. Which of the following is a net of a cube?

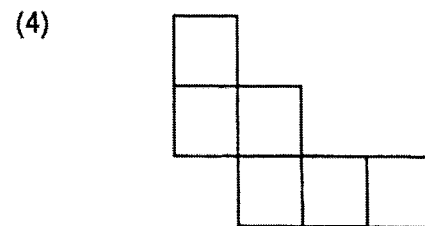
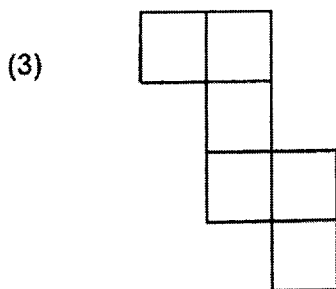
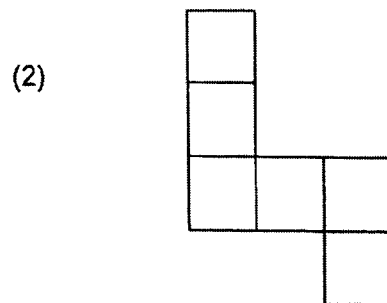
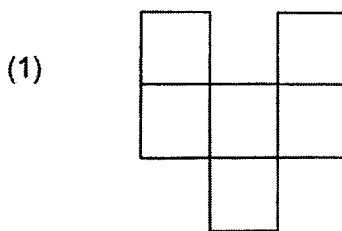

11. The table shows the marks scored by 5 students in a test.

Students	A	B	C	D	E
Marks	20	30	10	20	40

Which of the following bar graphs represents the information shown in the table above?

(1)

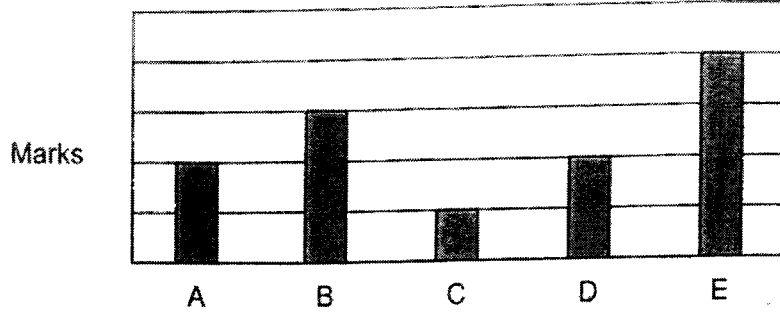

(2)

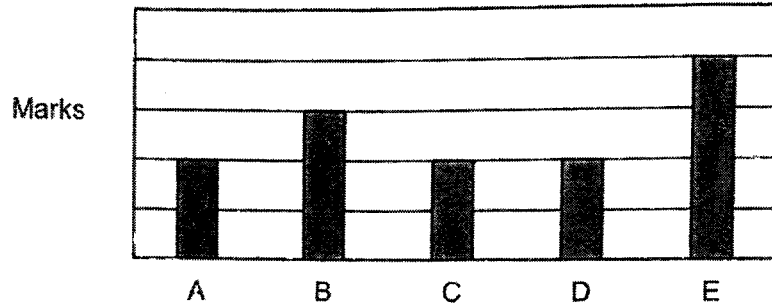

(3)

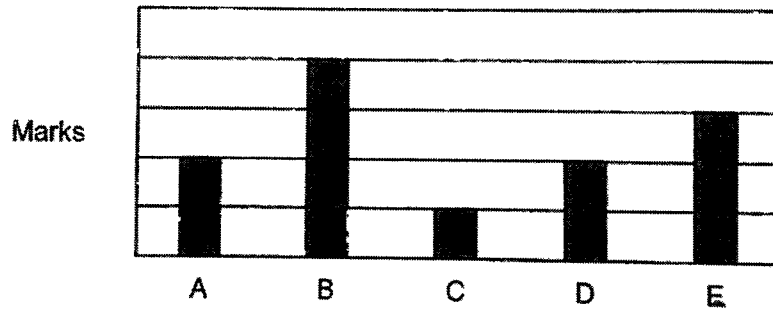

(4)

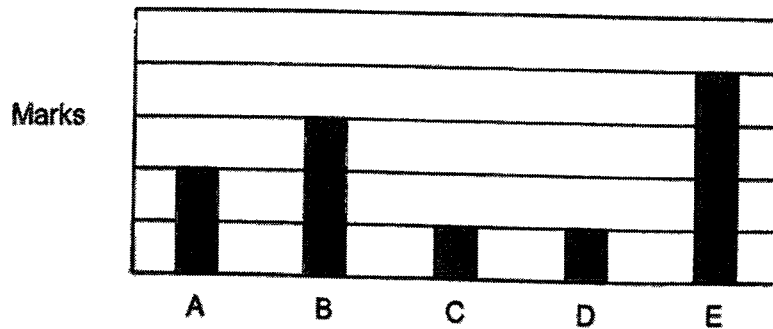

12. In the figure, AB, CD and EF are straight lines. Find  $\angle AOF$ .

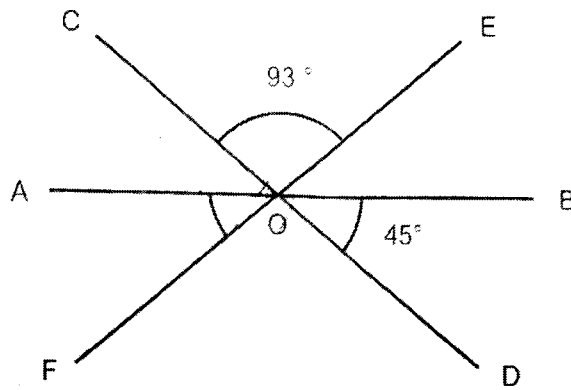

- (1)  $42^\circ$   
 (2)  $45^\circ$   
 (3)  $48^\circ$   
 (4)  $87^\circ$
13. Tom and Jerry were standing at X, facing the same place at first. Tom turned  $90^\circ$  clockwise to face the Library and Jerry turned  $225^\circ$  anti-clockwise. Where will Jerry face in the end?

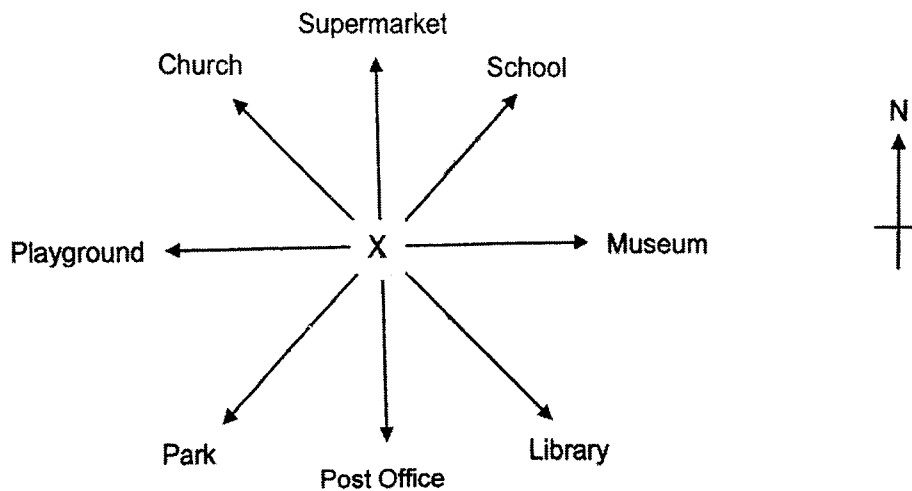

- (1) Church  
 (2) Post Office  
 (3) Park  
 (4) School

14. The table below shows the range of marks scored by a group of 220 students in a competition.

Marks	Number of students
70	24
75	44
80	108
85	36
90	8

20% of the students in this group qualified for the next round. What is the minimum score needed to qualify for the next round?

- (1) 75
  - (2) 80
  - (3) 85
  - (4) 90
15. At a party, 20% of the people were men, 55% of the remaining people were women and the rest were children. There were 100 men. How many children were there at the party?

- (1) 125
- (2) 180
- (3) 220
- (4) 500

**END OF BOOKLET A  
GO TO BOOKLET B**

PSLE  
Index No.



MARIS STELLA HIGH SCHOOL (PRIMARY)  
PRELIMINARY EXAMINATION  
PRIMARY 6 MATHEMATICS  
18 AUGUST 2023  
PAPER 1  
(BOOKLET B)

15 questions

25 marks

Total time for Booklets A and B: 1 hour

NAME : \_

CLASS : PRIMARY 6

INSTRUCTIONS TO CANDIDATES

1. DO NOT OPEN THIS BOOKLET UNTIL YOU ARE TOLD TO DO SO.
2. FOLLOW ALL INSTRUCTIONS CAREFULLY.
3. ANSWER ALL QUESTIONS.
4. WRITE YOUR ANSWERS IN THIS BOOKLET.
5. YOU ARE NOT ALLOWED TO USE A CALCULATOR.

MARKS OBTAINED FOR		
PAPER 1 (BOOKLET A)	/ 20	Parent's Signature: _____
PAPER 1 (BOOKLET B)	/ 25	
TOTAL	/ 45	Date: _____



Questions 16 to 20 carry 1 mark each. Write your answers in the spaces provided. For questions which require units, give your answers in the units stated. (5 marks)

Do not write in this space.

16. Find the value of  $(74 - 36) \times 10 + 6 \div 2$

Answer : \_\_\_\_\_

17. How many sixths are there in  $5\frac{1}{3}$ ?

Answer : \_\_\_\_\_

18. Find the value of  $12.2 - 5.47$

Answer : \_\_\_\_\_



19. How much water (in ml) is in the container?

Do not write in this space.

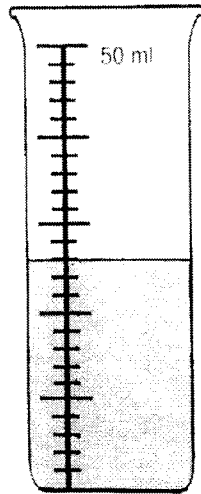

Answer : \_\_\_\_\_ ml

20. Given the line of symmetry line AB, shade 2 squares to complete the symmetric figure.

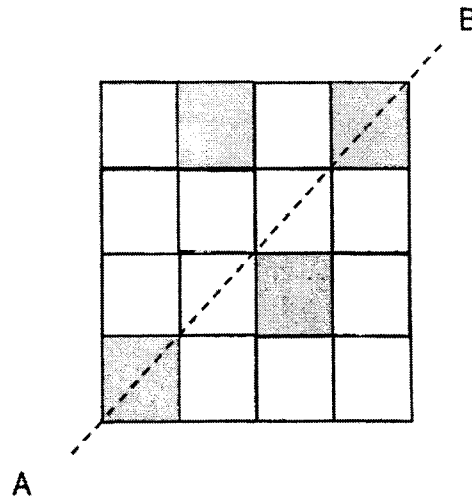

Questions 21 to 30 carry 2 marks each. Show your working clearly and write your answers in the spaces provided. For questions which require units, give your answer in the units stated. (20 marks)

Do not write in this space.

21. (a) Find the value of  $1 - \frac{1}{3} - \frac{1}{5}$

Answer : (a) \_\_\_\_\_

(b) Find the value of  $11 \div \frac{3}{5}$

Answer: (b) \_\_\_\_\_

22. Denise answered 20 questions in a survey. She took 3 min for each of the first 10 questions and twice as long for each of the remaining questions. She started her survey at 1.20 p.m. At what time did she complete her survey?

Answer : \_\_\_\_\_ p.m.



23. From the figure below, what is the minimum number of unit cubes that needs to be added to form a cuboid?

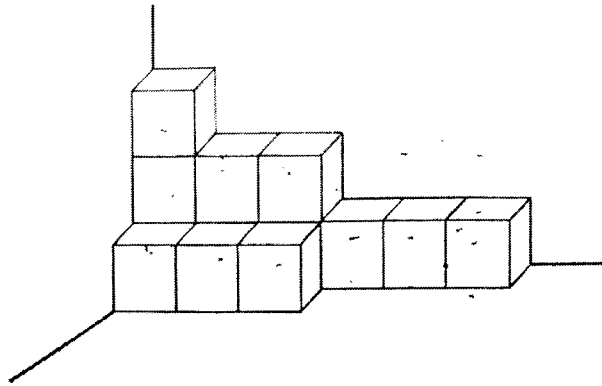

Do not write in this space.

Answer : \_\_\_\_\_

24. The ratio of the number of stickers Kingston had to the number of stickers Tim had was 8 : 5. After Kingston gave away 44 stickers, Tim had twice as many stickers as Kingston. How many stickers did they have at first?

Answer : \_\_\_\_\_



25. Pauline drove from her home to her office. The distance between her home and her office was 24 km. The average speed of her car was 60 km/h. Pauline left home at 0815, what time did she reach her office?

Do not write in this space.

Answer : \_\_\_\_\_

26. The pie chart shows the favourite snacks of students in School A and B.

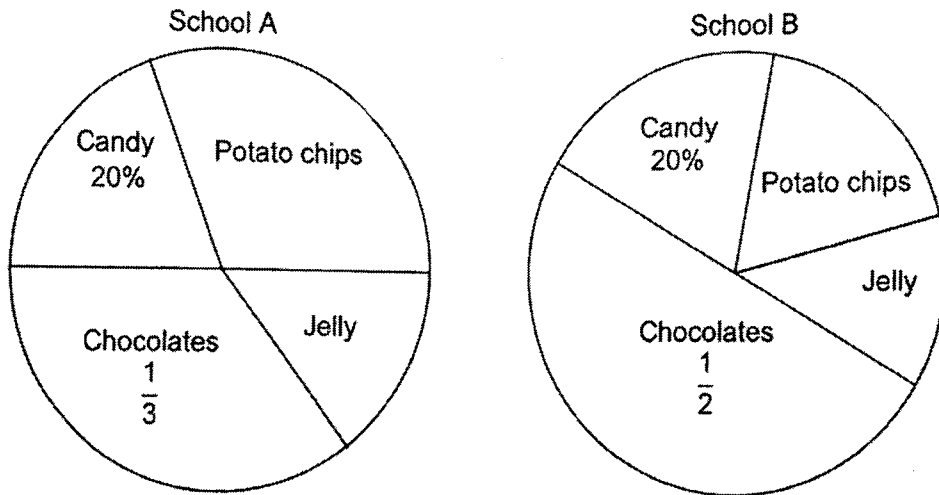

Each statement below is either true, false or not possible to tell from the information given. For each statement, put a tick (✓) in the correct column.

Statement	True	False	Not possible to tell
An equal number of students in School A and School B chose candy as their favourite snack.			
$\frac{3}{4}$ of the students in School B chose chocolates and candy as their favourite snacks.			

27. A parallelogram, ABCD is drawn on a square grid.

- (a) Draw a triangle that is  $\frac{1}{2}$  the area of the parallelogram ABCD. Label it EFG.
- (b) Draw a parallelogram that has twice the perimeter as the parallelogram ABCD. Label it WXYZ.

Do not write in this space.

Both triangle EFG and parallelogram WXYZ should not overlap parallelogram ABCD and each other.

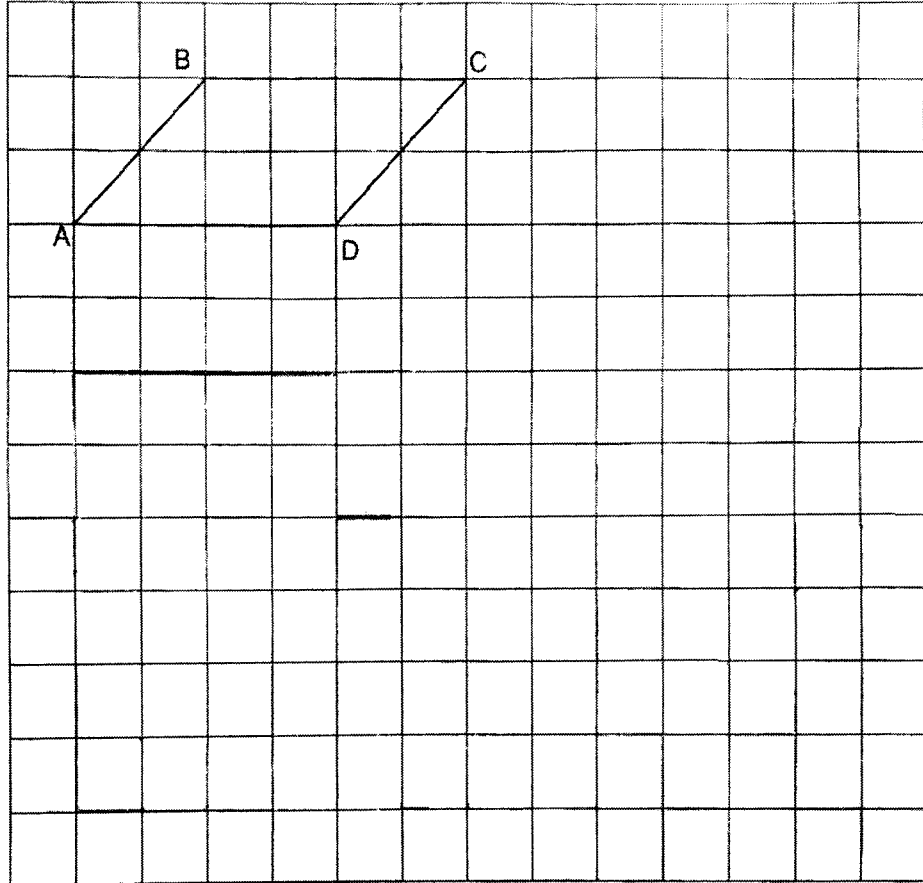

28. Andy had \$5x. After buying apples at 60¢ each, he had \$2x left. How many apples did Andy buy?

Answer : \_\_\_\_\_



29. Benedict has 2 cubical tanks, A and B. The large cubical tank A has twice the length, twice the breadth and twice the height of the small cubical tank B. The small cubical tank B is filled completely with 8 identical cubes. how many of such cubes is needed to fill the large cubical tank A completely?

Do not write in this space.

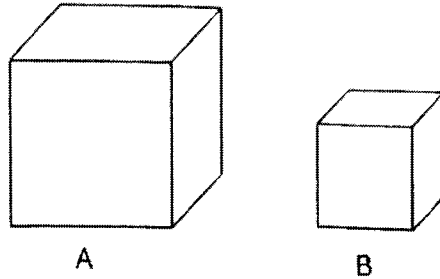

Answer : \_\_\_\_\_

30. In the figure, DEF is a straight line.  $\angle DEH = 150^\circ$  and  $\angle GEF = 110^\circ$ . Find  $\angle GEH$ .

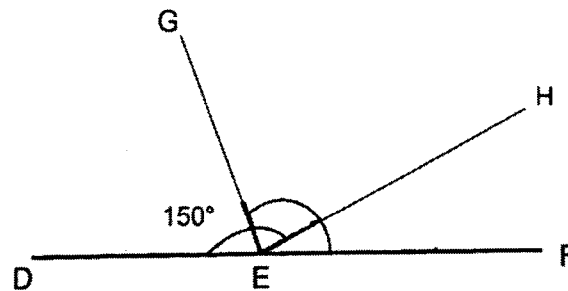

Answer : \_\_\_\_\_ °

End of Booklet B



PSLE  
Index No



MARIS STELLA HIGH SCHOOL (PRIMARY)  
PRELIMINARY EXAMINATION  
PRIMARY 6 MATHEMATICS  
18 AUGUST 2023  
PAPER 2

17 questions

55 marks

Time: 1 h 30 min

NAME :\_

CLASS : PRIMARY 6

**INSTRUCTIONS TO CANDIDATES**

1. DO NOT OPEN THIS BOOKLET UNTIL YOU ARE TOLD TO DO SO.
2. FOLLOW ALL INSTRUCTIONS CAREFULLY.
3. ANSWER ALL QUESTIONS.
4. SHOW YOUR WORKINGS CLEARLY AS MARKS ARE AWARDED FOR CORRECT WORKING.
5. WRITE YOUR ANSWERS IN THIS BOOKLET.
6. YOU ARE ALLOWED TO USE A CALCULATOR.

**MARKS OBTAINED FOR**

PAPER 1 (BOOKLET A & B)	/ 45	Parent's Signature: _____
PAPER 2	/ 55	
TOTAL	/100	
		Date: _____



Questions 1 to 5 carry 2 marks each. Show your working clearly and write your answers in the space provided. For questions which require units, give your answers in the units stated. (10 marks)

Do not write in this space.

1. The pie chart shows how Michael spent his money.

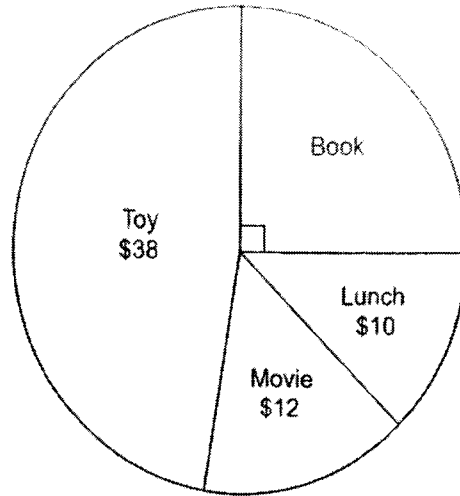

- (a) How much money did Michael spend on the book?

Answer : (a) \$ \_\_\_\_\_

- (b) What percentage of Michael's money was spent on lunch?

Answer : (b) \_\_\_\_\_ %

2. The bar graph shows the number of cups of ice cream sold in a shop.

Do not  
write in  
this space

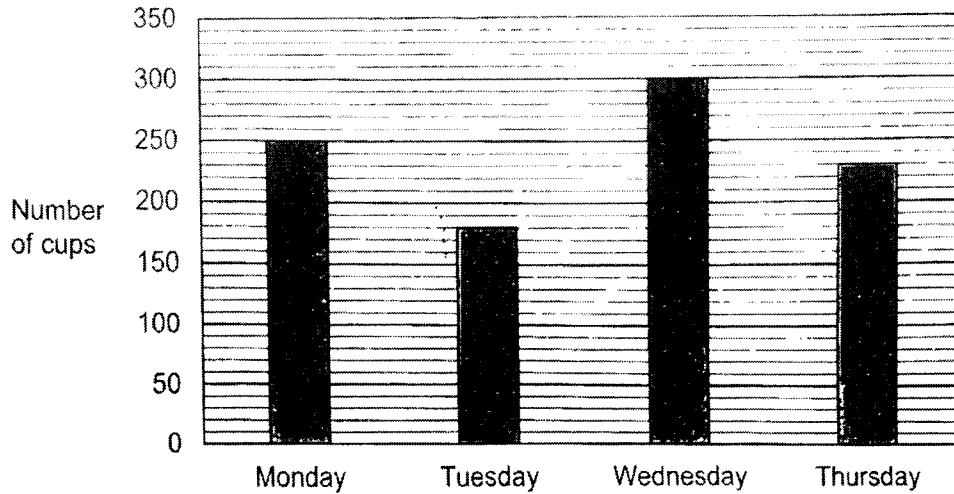

What is the average number of cups of ice cream sold each day?

Answer : \_\_\_\_\_

3. Jimmy gave his mother \$1200 of his salary. He gave  $\frac{5}{8}$  of the remainder of his salary to his brother and had  $\frac{1}{4}$  of his salary left. What was Jimmy's salary?

Answer : \$ \_\_\_\_\_

4. The graph shows the number of toys sold by a shop from March to June.

Do not write in this space.

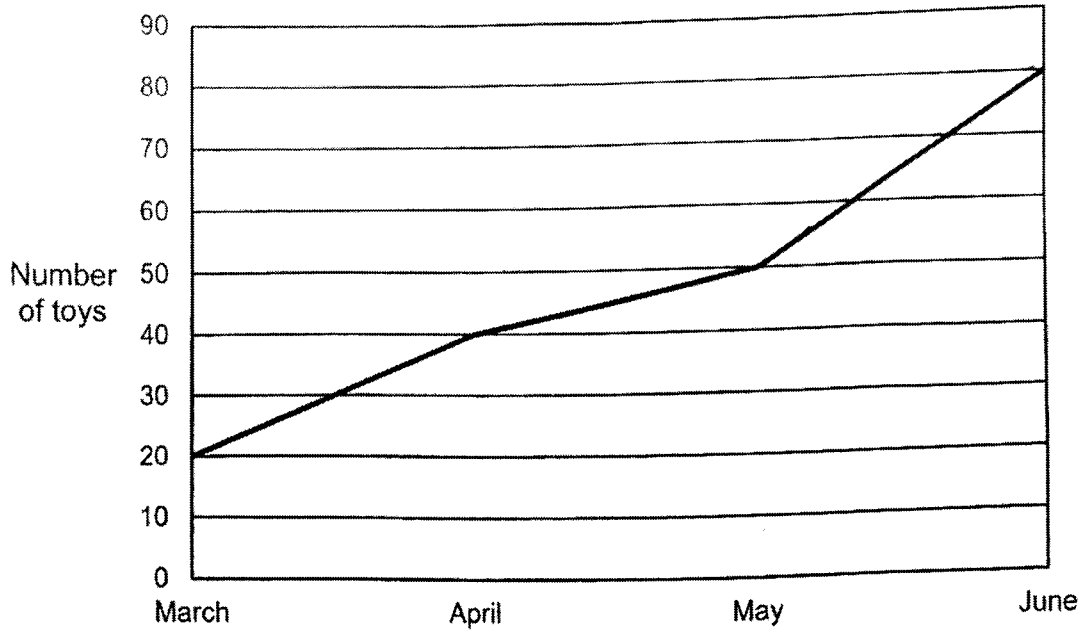

In which 1-month interval was the percentage increase of toys sold the most?

Answer : \_\_\_\_\_ to \_\_\_\_\_

5. A 1 m wide path cuts across a rectangular field along its length and breadth, forming a path as shown. What is the area of the path?

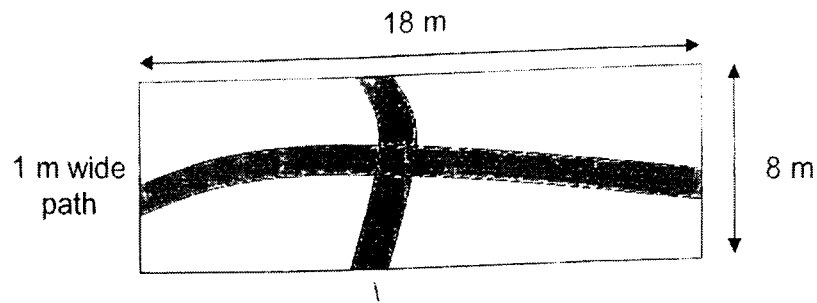

Answer : \_\_\_\_\_ m<sup>2</sup>

For questions 6 to 17, show your working clearly and write your answers in the spaces provided. The number of marks available is shown in brackets [ ] at the end of each question. (45 marks)

Do not write in this space.

6. Mr Lee had a piece of wire  $26y$  cm long. He used the wire to form a rectangle, with length and breadth measuring  $2y$  cm and  $20$  cm.

(a) Express the length of the remaining wire in terms of  $y$ .

Answer : (a) \_\_\_\_\_ [1]

- (b) Mr Lee used the remaining wire to make a square. If  $y = 4$ , what was the length of one side of the square?

Answer : (b) \_\_\_\_\_ [2]

7. The diagram below shows 4 identical right-angled isosceles triangles with a quadrant within it. The quadrant has a radius of  $7.5$  cm.

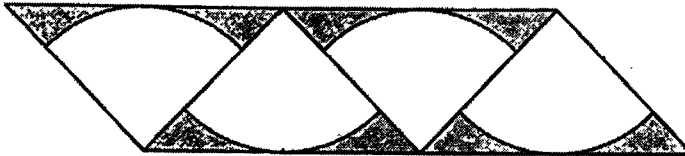

(Take  $\pi = 3.14$ )

Find the area of the shaded part.

Answer : \_\_\_\_\_ [3]



8. The figure shows a square ABCD.  $EH = EF = EG$ . Find  $\angle FGH$ .

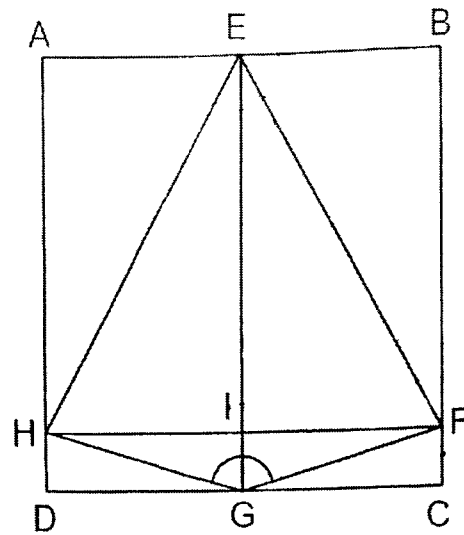

Do not write in this space.

Answer : \_\_\_\_\_ [3]

9. At 8 a.m., Joey travelled from Town X to Town Y at a constant speed of 120 km/h. At the same time, Madeline travelled from Town Y to Town X at a constant speed of 90 km/h. At 9.20 a.m., they were 50 km apart after driving past each other. What is the distance between Town X and Town Y?

Do not write in this space.

Answer : \_\_\_\_\_ [3]

10. X is a cubical tank of sides 20 cm and Y is a rectangular tank. The base of Y has dimensions as shown. X was fully filled with water and Y was empty.

Do not  
write in  
this  
space.

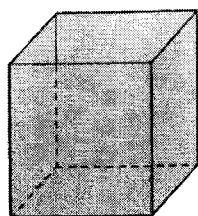

X

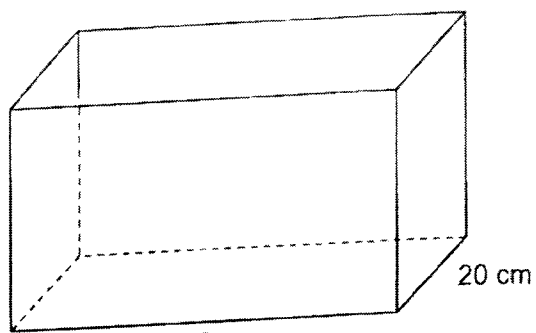

Y

Samuel poured some water from X into Y without spilling. After that, the heights of the water level of X and Y were the same. What was the final height of the water level in both tanks?

Answer : \_\_\_\_\_ [3]



11. The table shows the scores of 4 students in a Math test. Some of the scores are covered by an ink patch.

Name	Test Score
Aloysius	6
Benedict	8
Charles	7
Dominic	82

The average score of Charles and Dominic is 80. The average score of Aloysius, Benedict and Charles is 74. What is the largest possible score that Benedict has achieved?

Do not  
write in  
this  
space.

Answer : \_\_\_\_\_ [3]

12. Peter had some stickers. He gave half of them and an additional 60 stickers to Samuel. Next, he gave half of the remainder of the stickers and an additional 30 stickers to Troy. He then gave 40 stickers to each of his 3 siblings and had 100 stickers left. How many stickers did Peter have at first?

Do not  
write in  
this  
space.

Answer : \_\_\_\_\_ [4]

13. There were 400 adults attending a concert in a stadium. During the break,  $\frac{1}{3}$  of the men and  $\frac{3}{5}$  of the women left the stadium. 224 adults remained in the stadium. How many women were there in the stadium at first?

Do not  
write in  
this  
space.

Answer : \_\_\_\_\_ [4]

--

14. In the figure, a rectangular piece of paper is folded twice.  $\angle GDA = 36^\circ$  and  $\angle ADE = 10^\circ$ .

Do not write in this space.

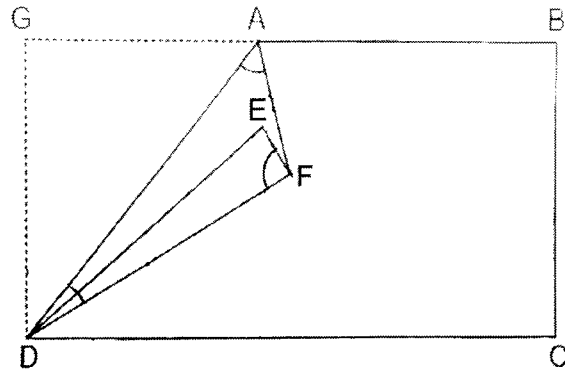

- (a) Find  $\angle DAF$ .

Answer : (a) \_\_\_\_\_ [2]

- (b) Find  $\angle DFE$ .

Answer : (b) \_\_\_\_\_ [2]

15. In the morning, Mrs Chen baked muffins of 3 different flavours - Chocolate, strawberry and vanilla. The ratio of the number of chocolate muffins to the number of strawberry muffins was 3 : 5. There were 28 more strawberry muffins than chocolate muffins. There were 10 more vanilla muffins than strawberry muffins.

Do not  
write in  
this  
space.

- (a) How many vanilla muffins did she bake in the morning?

Answer : (a) \_\_\_\_\_ [2]

In the afternoon, she baked some more chocolate and vanilla muffins. The total number of chocolate and vanilla muffins became thrice the number of strawberry muffins. The percentage increase of the chocolate muffins was between 8% to 10%.

- (b) How many vanilla muffins did she bake in the afternoon?

Answer : (b) \_\_\_\_\_ [3]

--

16. The figure shows a circle and 6 identical quarter circles. The radius of each quarter circle is 8 cm. Line XY passes through the centre of the circle.

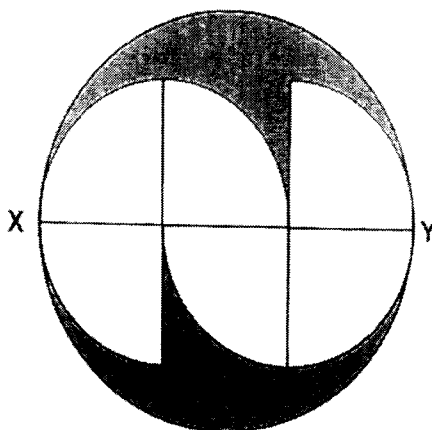

Do not  
write in  
this  
space.

(Take  $\pi = 3.14$ )

- (a) Find the area of the shaded part.

Answer : (a) \_\_\_\_\_ [2]

- (b) Find the perimeter of the shaded part.

Answer : (b) \_\_\_\_\_ [3]

17. In June, Mr Tan saved 20% of his salary. In July, his monthly salary increase by \$600 and he saved 15% of his new monthly salary. Given that Mr Tan saved the same amount of money in both months. find the percentage increase in Mr Tan's salary.

Do not  
write in  
this  
space.

Answer : \_\_\_\_\_ [5]

End of Paper 2

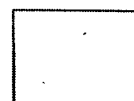





**SCHOOL :** Maris Stellar PRIMARY SCHOOL  
**LEVEL :** PRIMARY 6  
**SUBJECT :** MATH  
**TERM :** 2023 Prelims

**PAPER 1 BOOKLET A**

<b>Q 1</b>	<b>Q2</b>	<b>Q3</b>	<b>Q4</b>	<b>Q5</b>	<b>Q6</b>	<b>Q7</b>	<b>Q8</b>	<b>Q9</b>	<b>Q10</b>
<b>2</b>	<b>4</b>	<b>3</b>	<b>2</b>	<b>3</b>	<b>4</b>	<b>3</b>	<b>1</b>	<b>4</b>	<b>3</b>
<b>Q10</b>	<b>Q12</b>	<b>Q13</b>	<b>Q14</b>	<b>Q15</b>					
<b>1</b>	<b>1</b>	<b>2</b>	<b>3</b>	<b>2</b>					

**PAPER 1 BOOKLET B**

<b>Q16)</b>	<b>383</b>
<b>Q17)</b>	<b>32</b>
<b>Q18)</b>	<b>6.73</b>
<b>Q19)</b>	<b>26</b>
<b>Q20)</b>	
<b>Q21</b> <b>a)</b>	$\frac{7}{15}$
<b>Q21</b> <b>b)</b>	$18\frac{1}{3}$
<b>Q22)</b>	<b>2.50</b>

Q23)	23
Q24)	104
Q25)	0839
Q26)	Not possible to tell False
Q27	
Q28	$\frac{3x}{0.6}$
Q29	64
Q30	80

**PAPER 2**

Q1a)	$38 + 12 + 10 = 60$ $60 \div 3 = 20$
Q1b)	$20 * 4 = 80$ $\frac{10}{80} * 100 = 12.5\%$
Q2)	$250 + 180 + 300 + 230 = 960$ $960 \div 4 = 240$
Q3)	$\frac{1}{4} \div 3 * 8 = \frac{2}{3}$ $1200 = \frac{1}{3}$ $\frac{3}{3} = 1200 * 3 = 3600$
Q4)	March to April
Q5)	$18 + 8 = 26$ $26 - 1 = 25$

Q6a)	$22y - 40km$
Q6b)	$(22 * 4) - 40 = 48$ $48 \div 4 = 12cm$
Q7)	$3.14 * 7.5 * 7.5 = 126.625$ $7.5 * 2 = 15$ $15 * 5 = 225$ $225 - 176.625 = 48.375$
Q8)	$180 - 30 = 150$
Q9)	$1 \text{ hour } 20 \text{ mins} = 1\frac{1}{3}h$ $1\frac{1}{3} * 120 = 160$ $160 + 120 - 50 = 230$
Q10)	$20^3 = 8000$ $60 * 20 = 1200$ $20 * 20 = 400$ $8000 \div 1600 = 5cm$
Q11)	$80 * 2 = 160$ $160 - 82 = 78$ $74 * 3 = 222$ $222 - 78 - 60 = 84$
Q12)	$120 + 30 + 100 = 250$ $60 + 250 + 250 = 560$ $560 * 2 = 1120$
Q13)	$\frac{2}{3}m + \frac{2}{5}w = 224$ $\frac{1}{5}m + \frac{1}{5}w = 112$ $\frac{3}{3}m + \frac{3}{5}w = 112 * 3 = 336$ $M + W = 400$ $\frac{2}{5}w = 400 - 336 = 65$ $\frac{1}{5}w = 65 \div 2 = 32$ $\frac{5}{5}w = 32 * 5 = 160$
Q14a)	$180 - 90 - 36 = 54^\circ$
Q14b)	$(36 + 0) \div 2 = 13^\circ$ $180 - 90 - 13 = 77^\circ$
Q15a)	$C: S$ $3: 5$ $2u = 28$ $1u = 14$ $5 * 14 = 70$ $70 + 10 = 80$

<b>Q15b)</b>	$70 * 3 = 210$ $14 * 3 = 42$ <b>8% increase = 3.20</b> <b>10% increase = 4.20</b> $42 + 4 = 46$ $210 - 46 - 80 = 84$ Type equation here.
<b>Q16a)</b>	$\frac{1}{4} * 3.14 * 8 * 8 = 50.24$ $8 * 3 = 24$ $24 \div 2 = 12$ $12 * 12 * 3.14 = 452.16$ $50.24 * 6 = 301.44$ $452.16 - 301.44 = 15072cm^2$
<b>Q16b)</b>	$3.14 * 24 = 75.36$ $\frac{1}{4} * 3.14 * 16 = 12.56$ $12.26 * 6 = 75.36$ $75.36 * 2 = 150.72$ $150.72 + 8 + 8 = 166.72cm$
<b>Q17</b>	$15\% * 600 = 90$ $90 = 5\%$ $100\% = 1800$ $\frac{600}{1800} * 100\% = 33\frac{1}{3}\%$