



NAN HUA PRIMARY SCHOOL
CONTINUAL ASSESSMENT 1 – 2018
PRIMARY 6

MATHEMATICS

Paper 1

Section A: 15 Multiple Choice Questions (20 marks)

Section B: 15 Short Answer Questions (25 marks)

Total Time for Paper 1: 1 hour

INSTRUCTION TO CANDIDATES

1. Write your name and index number in the space provided.
2. Do not turn over the page until you are told to do so.
3. Follow all instructions carefully.
4. Answer all questions.
5. Shade your answers in the Optical Answer Sheet (OAS) provided for Questions 1-15.
6. You are not allowed to use calculator for Paper 1.

Marks Obtained

Paper 1	Booklet A		/ 45
	Booklet B		
Paper 2			/ 55
Total			/ 100

Name : _____ ()

Class : 6 _____

Date : 5 March 2018

Parent's Signature : _____

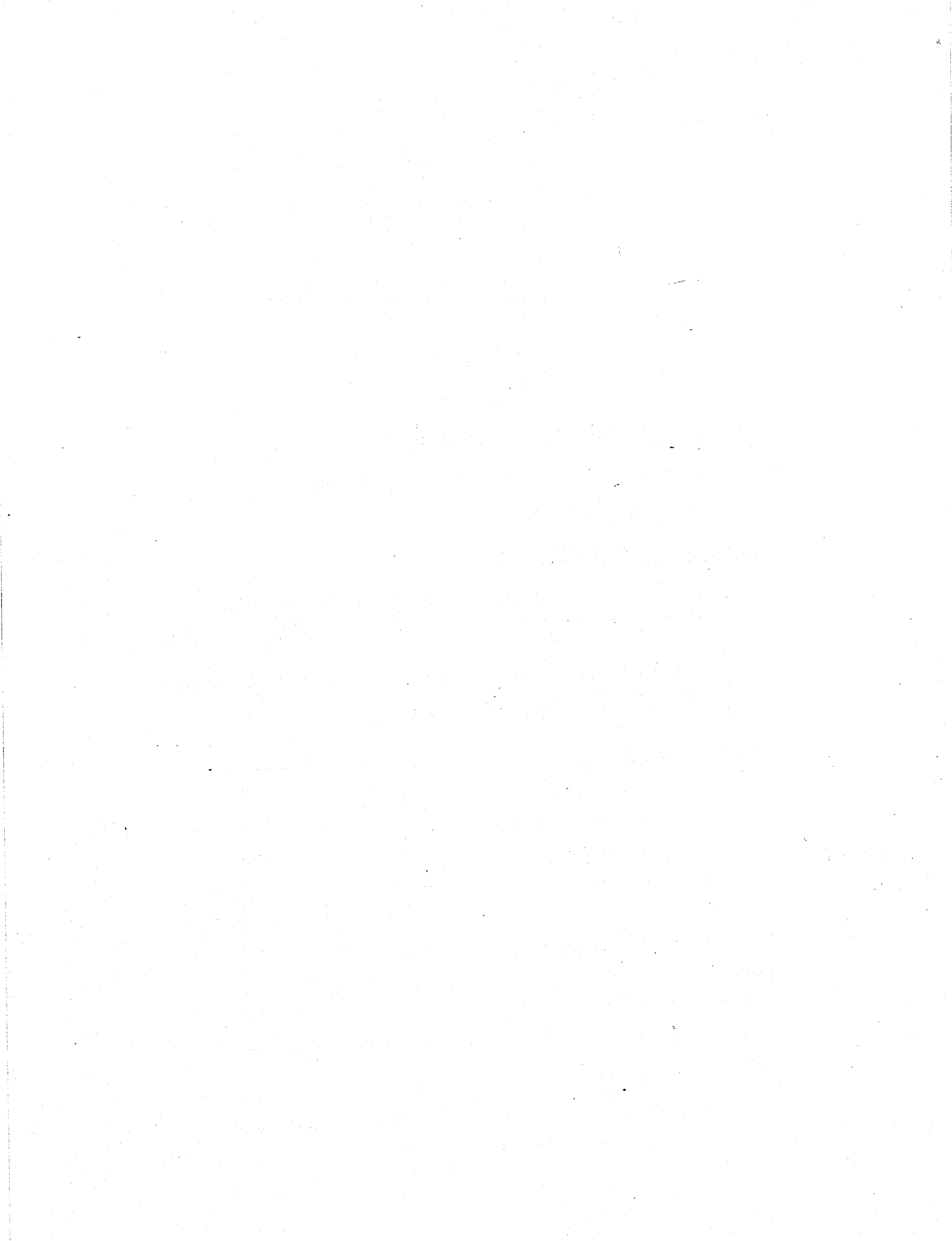

Section A (20 marks)

Questions 1 to 10 carry 1 mark each. Questions 11 to 15 carry 2 marks each.
For each question, four options are given. One of them is the correct answer.
Make your choice and shade your answer (1, 2, 3 or 4) on the Optical Answer Sheet.
(20 marks)

1. There were 416 820 visitors to a tourist attraction last year. Express this number to the nearest ten thousand.

- (1) 400 000
- (2) 420 000
- (3) 417 000
- (4) 410 000

2. What does the digit 2 in 3 728 459 stand for?

- (1) 2 hundreds
- (2) 2 thousands
- (3) 20 thousands
- (4) 200 thousands

3. Which of the following has the same value as $\frac{4}{5} \div 3$?

- (1) $\frac{4}{5}$ of 3
- (2) 3 times of $\frac{5}{4}$
- (3) 4 times of $\frac{5}{3}$
- (4) $\frac{1}{3}$ of $\frac{4}{5}$

4. A is 3 times of B, and B is 3 times of C. What is the ratio of A : B : C?
- (1) 3 : 1 : 1
 - (2) 3 : 3 : 1
 - (3) 9 : 1 : 3
 - (4) 9 : 3 : 1
5. 20% of a group of children are boys. Given that there are 40 boys, how many children are there in the group?
- (1) 8
 - (2) 32
 - (3) 160
 - (4) 200
6. Jack is $\frac{5}{6}$ as heavy as Jill. What is the ratio of Jill's mass to their total mass?
- (1) 5 : 6
 - (2) 6 : 5
 - (3) 5 : 11
 - (4) 6 : 11

7. The picture below shows a Math Activity Book, not drawn to scale. What is the best estimate of its actual length and breadth?

	Length (cm)	Breadth (cm)
(1)	12	20
(2)	22	28
(3)	42	50
(4)	52	68

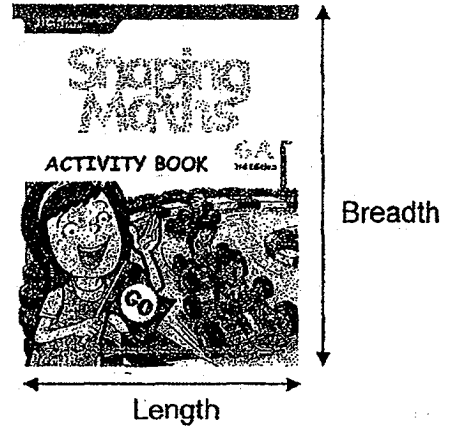

8. Express 0.8 as a percentage.

- (1) 0.008%
- (2) 0.08%
- (3) 8%
- (4) 80%

9. The table below shows the original price and the sale price of a dress. Find the percentage change in price.

Original Price	Sale Price
\$150	\$120

- (1) 20%
- (2) 25%
- (3) 80%
- (4) 125%

10. AB and CD are straight lines. $\angle COA = 85^\circ$, $\angle AOE = 27^\circ$ and $\angle DOF = 32^\circ$. Find $\angle BOF$.

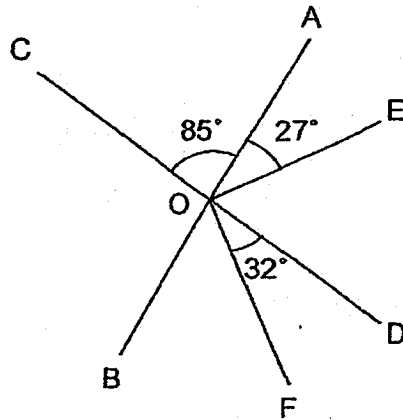

- (1) 53°
(2) 58°
(3) 68°
(4) 80°
11. Winnie had $\frac{3}{8}$ as many dolls as Lindy. Lindy gave half of her dolls to Winnie. What was the ratio of the number of Winnie's dolls to the number of Lindy's dolls in the end?

- (1) 7:8
(2) 7:4
(3) 3:4
(4) 4:7

12. A sum of money is divided among Ali, Bala and Calvin in the ratio of 3 : 4 : 5. Calvin receives \$80 more than Ali, what is the sum of money?

- (1) \$120
- (2) \$192
- (3) \$480
- (4) \$960

13. The figure below shows 20 squares. How many more squares must be shaded so that 40% of the figure is unshaded?

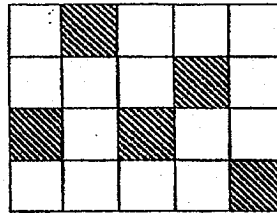

- (1) 7
- (2) 8
- (3) 12
- (4) 13

14. The table below shows the parking charges at a carpark in a shopping mall.

Time	Parking Charges
First hour	\$2.50
Every additional half hour	\$1.20

Mr Li parked his car at the carpark from 8.00 a.m. to 11.15 a.m.

How much did he pay?

- (1) \$6.10
 - (2) \$7.30
 - (3) \$7.90
 - (4) \$8.50
15. Elaine had 40 hairclips and Dora had 64 hairclips.
Elaine gave Dora 24 hairclips.
What was the new ratio of the number of Elaine's hairclips to the number of Dora's hairclips?
Give your answer in the simplest form.

- (1) 2 : 11
- (2) 11 : 2
- (3) 5 : 11
- (4) 11 : 5

Section B (20 marks)

Questions 16 to 20 carry 1 mark each. Write your answers in the spaces provided.
For questions which require units, give your answers in the units stated.

[10 marks]

16. Find the value of $\frac{2}{3} + \frac{4}{5}$. Give your answer in the simplest form.

Do not write
in this space

Ans: _____

17. Express 68% as a fraction.

Ans: _____

18. Find the value of $10.5 - 6.42$.

Ans: _____



19. Find the value of $4 \div \frac{2}{3}$.

Do not write
in this space

Ans: _____

20. Find the missing number in the box.

$$12 : 15 = \square : 25$$

Ans: _____

Questions 21 to 30 carry 2 marks each. Show your working clearly in the space provided for each question and write your answers in the spaces provided. For each questions which require units, give your answers in the units stated. [20 marks]

21. A triangle is shown in the square grid below. What is the area of the shaded triangle?

Do not write in this space

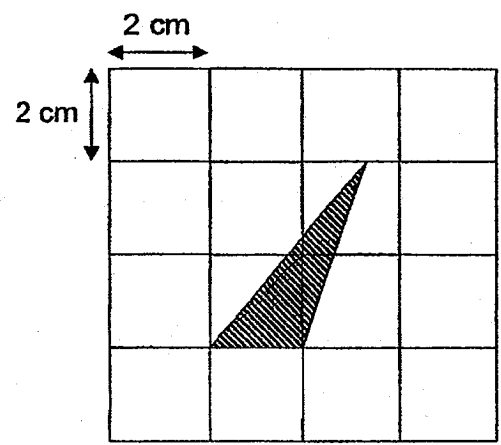

Ans : _____ cm²

22. For every 5 apples that Carl gets, Alan gets 7. Alan gets 35 apples.
How many apples does Carl get?

Do not write
in this space

Ans : _____

23. Study the following solid. Draw its top view on the square grid provided below.

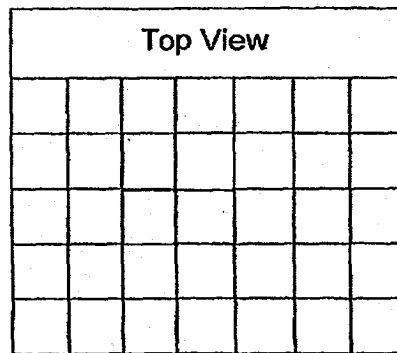
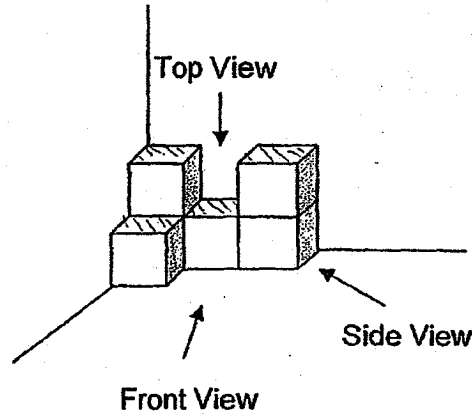

24. Mrs Amos had a packet of flour. She used 20% of the flour to make some cupcakes and 60% of the remaining flour to bake some cookies. What percentage of the flour was left?

Do not write
in this space

Ans : _____ %

-
25. Damien's scores for 5 games are shown in the table below.

Game	1 st	2 nd	3 rd	4 th	5 th
Score	5	10	0	8	17

Find his average score.

Ans : _____

26. Jane bought $\frac{4}{5}$ m of ribbon. She cut the ribbon equally into shorter pieces of $\frac{1}{4}$ m each. What is the length of the remaining piece?
Give your answer as a fraction in the simplest form.

Do not write
in this space

Ans: _____ m

27. The breadth of a rectangle is $\frac{2}{3}$ of its length.
The perimeter is 60 cm. Find the area of the rectangle.

Ans : _____ cm²



28. $\frac{1}{3}$ of Ray's money is the same as $\frac{2}{5}$ of Henry's money.

What is the ratio of Ray's money to Henry's money?

80 minutes

Do not write
in this space

Ans : _____

29. Clara folded a piece of rectangular paper into the following shape as shown below. Find the area of the rectangular paper.

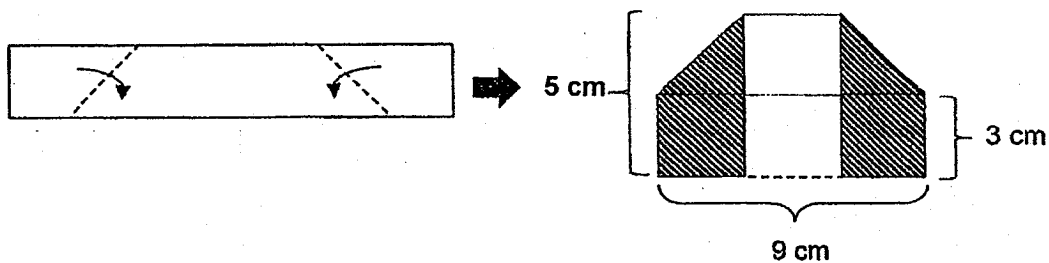

Ans: _____ cm²



30. A rectangular tank was filled with some water. A tap was turned on for 60 minutes for more water to flow into the tank. The line graph shows the volume of water in the tank over the 60 minutes.

Do not write in this space

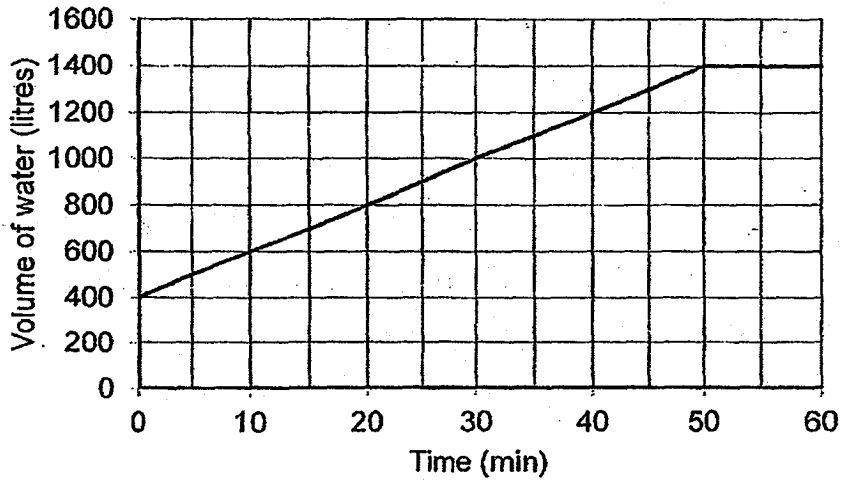

Study the graph above carefully and answer the following questions. Fill in your answer in the table below.

Question	Answer
a) What was the amount of water in the tank before the tap was turned on?	litres
b) What was the capacity of the tank?	litres

END OF PAPER



**NAN HUA PRIMARY SCHOOL
CONTINUAL ASSESSMENT 1 – 2018
PRIMARY 6**

MATHEMATICS

Paper 2

Total Time for Paper 2: 1 hour 30 minutes

5 Short Answer Questions (10 marks)

12 Structured / Long Answer Questions (45 marks)

INSTRUCTION TO CANDIDATES

- 1. Write your name and index number in the space provided.**
- 2. Do not turn over the page until you are told to do so.**
- 3. Follow all instructions carefully**
- 4. Answer all questions and show your workings clearly.**
- 5. You are allowed to use a calculator.**

Marks Obtained

Total		/ 55
--------------	--	-------------

Name : _____ ()

Class : 6 _____

Date : 5 March 2018

Parent's Signature : _____

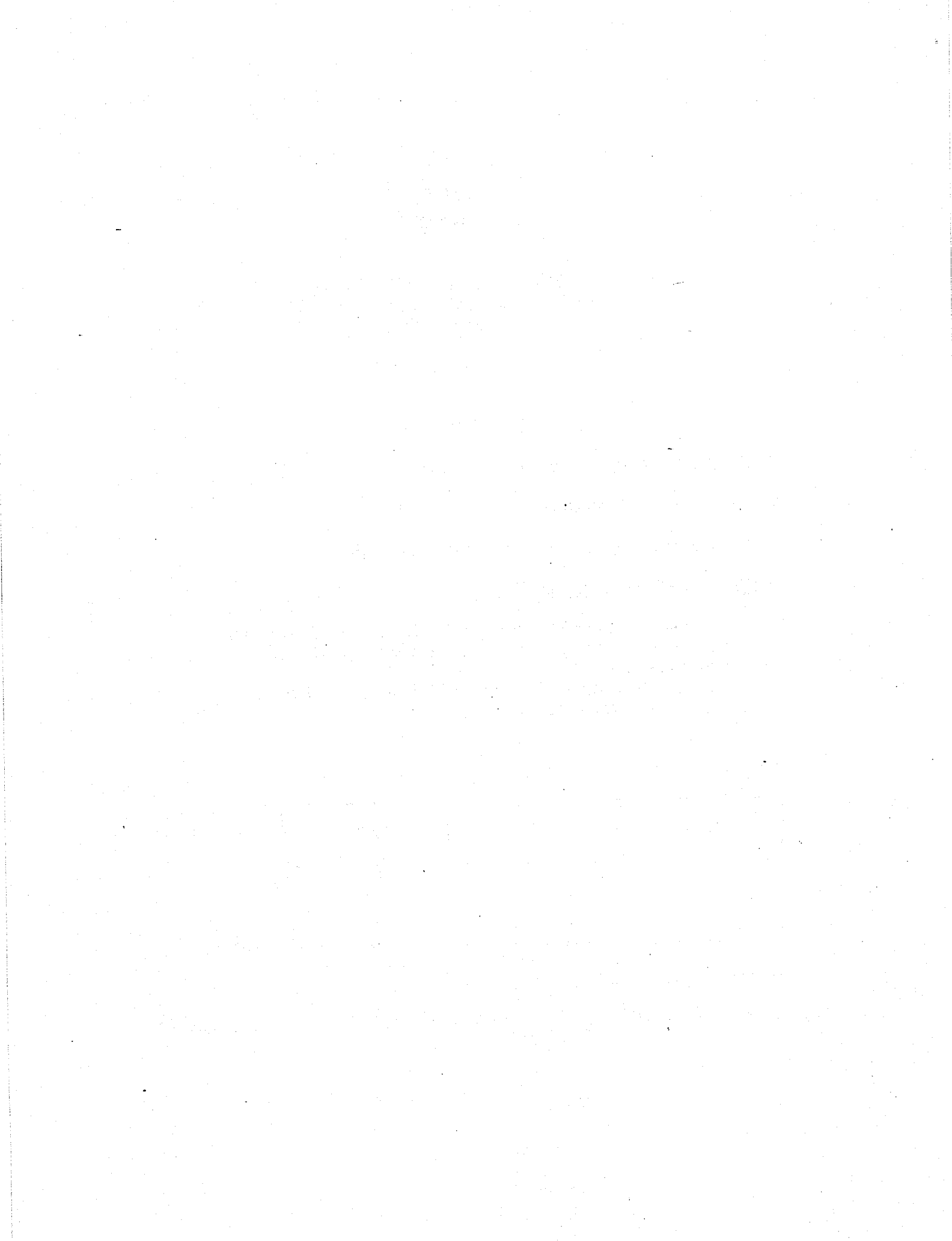

Paper 2

Questions 1 to 5 carry 2 marks each. Show your workings clearly and write your answers in the space provided. For questions which require units, give your answers in the units stated. (10 marks)

Do not write
in this space

1. On an excursion, there was 1 teacher to each group of 20 pupils. There were 180 pupils in total. How many teachers were there on the excursion?

Ans: _____

2. 35% of a number is 70. What is 50% of the number?

Ans: _____

3. 10 cones were placed at an equal distance apart on a $\frac{3}{4}$ - km path.

How far apart was each cone?

Express your answer as a fraction in the simplest form.

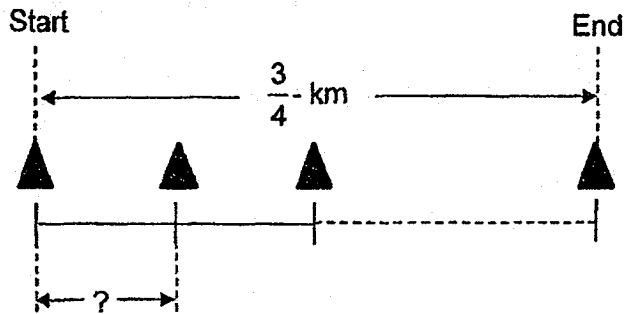

Ans: _____ km

Do not write
in this space

4. For every 5 keychains that Angel buys, she gets 1 keychain free. Angel needs to get 80 keychains, what is the least number of keychains she has to buy?

Ans: _____

5. The figure is made up of two identical rectangles ABNM and MNCD.

Rectangle MNCD is made up of 5 identical smaller rectangles.

What fraction of Figure ABCD is shaded?

Give your answer in the simplest form.

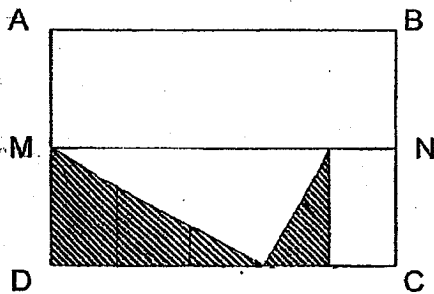

Do not write
in this space

Ans : _____



For questions 6 to 17, show your working clearly and write your answers in the spaces provided. The number of marks available is shown in brackets [] at the end of each question or part-question. (45 marks)

6. The bar graph shows the amount of money collected from a charity event by four Primary 6 classes.

Do not write
in this space

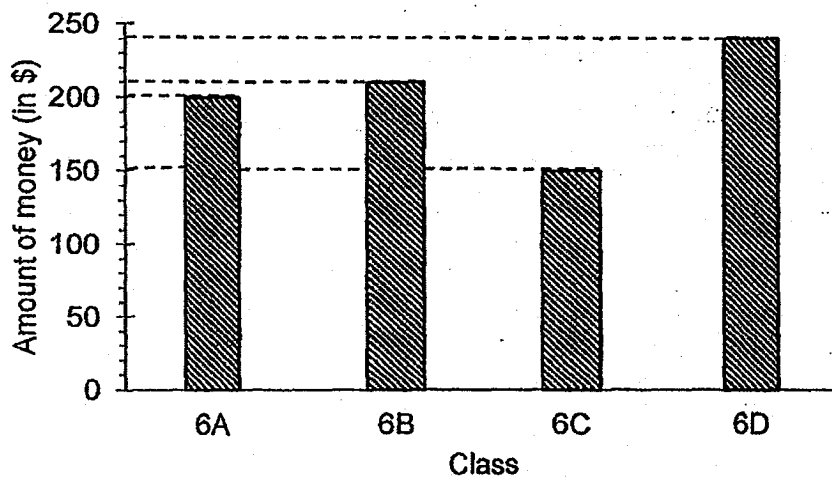

- (a) What was the total amount of money collected by the four classes?
- (b) Class 6E collected \$275 from the charity event. What was the average amount of money collected by the five classes?

Ans: (a) _____ [1]

(b) _____ [2]

7. There are 42 children in a class. 40% of the boys and 50% of the girls like to eat vegetables. There are 19 children who like to eat vegetables. Find the number of boys in the class.

Do not write
in this space

Ans: _____ [3]

8. There are 30 coins in a bag. They consist of twenty-cent and fifty-cent coins. The total value of the coins is \$9.30. How many twenty-cent coins are these?

Ans: _____ [3]

9. Ali has 210 balls. 20% of them are red. How many red balls must he buy so that 30% of the total balls are red balls?

Do not write
in this space

Ans: _____ [3]

10. ABCD is a square. QPD and APC are straight lines. $QC = BC$ and $\angle PCQ = 13^\circ$. Find $\angle ADQ$.

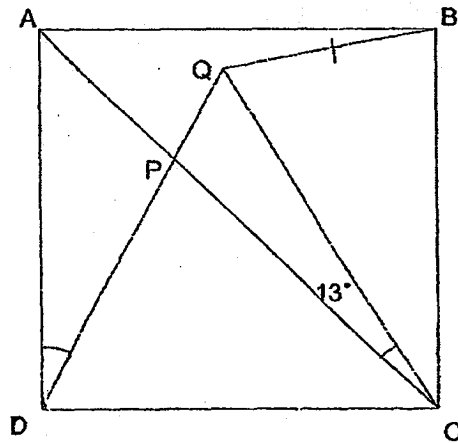

Ans: _____ [3]

11. A florist had 66 more stalks of roses than tulips. She sold $\frac{1}{3}$ of the roses and $\frac{3}{5}$ of the tulips. She sold 74 more tulips than roses. How many roses and tulips did she have left?

Do not write
in this space



Ans: _____ [4]

12. In the figure, ABCD is a rectangle. DC = 10 cm and the height of triangle DFC is 9 cm. The area of the shaded part EGCD is $\frac{5}{9}$ the area of triangle DFC and the area of the shaded part EGCD is $\frac{5}{6}$ the area of rectangle ABCD. Find the length of BC.

Do not write
in this space

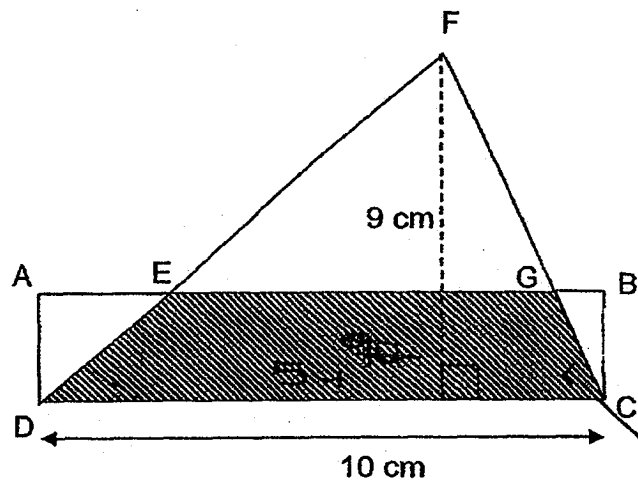

Ans: _____ [4]

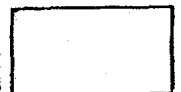

13. Alan had some cards and he gave some to two friends, Ben and Carl.

Alan first gave $\frac{1}{3}$ of his cards and 8 more cards to Ben.

Alan then gave $\frac{3}{4}$ of the remainder to Carl and 2 more cards.

In the end, Alan was left with 46 cards. How many cards did Alan have at first?

Do not write
in this space

Ans: _____ [4]

14.

Nan Hua Furniture Shop
CLEARANCE SALE!

20%
OFF
Storewide

Do not write
in this space

Mr Rahmat bought a set of sofa and a bed from Nan Hua Furniture Shop.
The discounted price of the set of sofa was \$240 less than the usual price.
The discounted price of the bed was \$180 less than the usual price.
How much did he pay altogether?

Ans: _____ [4]

15. Devi bought some red and blue beads to make a necklace. The ratio of the number of red beads to the number of blue beads is 3 : 5. After making the necklace, the ratio of the number of red beads to the number of blue beads became 2 : 5. A total of 21 red beads and $\frac{2}{3}$ of the blue beads were used to make the necklace. How many red and blue beads did Devi buy altogether?

Do not write
in this space

Ans: _____ [4]

16. Xavier, Yan and Zac wanted to buy a toy. Xavier agreed to pay 40% of the cost of the toy while Yan agreed to pay 30% of the remaining amount. The balance will be paid by Zac. A few days later, they bought the toy. However, the price of the toy increased by 20%. As a result, Xavier paid \$60 for his share.

Do not write
in this space

- (a) How much did the toy cost before the price increase?
(b) How much did Zac pay for the toy?

Ans: (a) _____ [3]

(b) _____ [2]

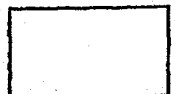

17. Samuel had some coins. The number of ten-cent coins was $\frac{2}{5}$ the number of twenty-cent coins. Samuel took out 10 twenty-cent coins from the bag and exchanged them for ten-cent coins of equal value. The ratio of the number of ten-cent coins to the number of twenty-cent coins became 8: 5. How many twenty-cent coins and ten-cent coins did he have at first?

Do not write
in this space

Ans: No. of ten-cent coins = _____

No. of twenty-cent coins = _____ [5]

End of Paper

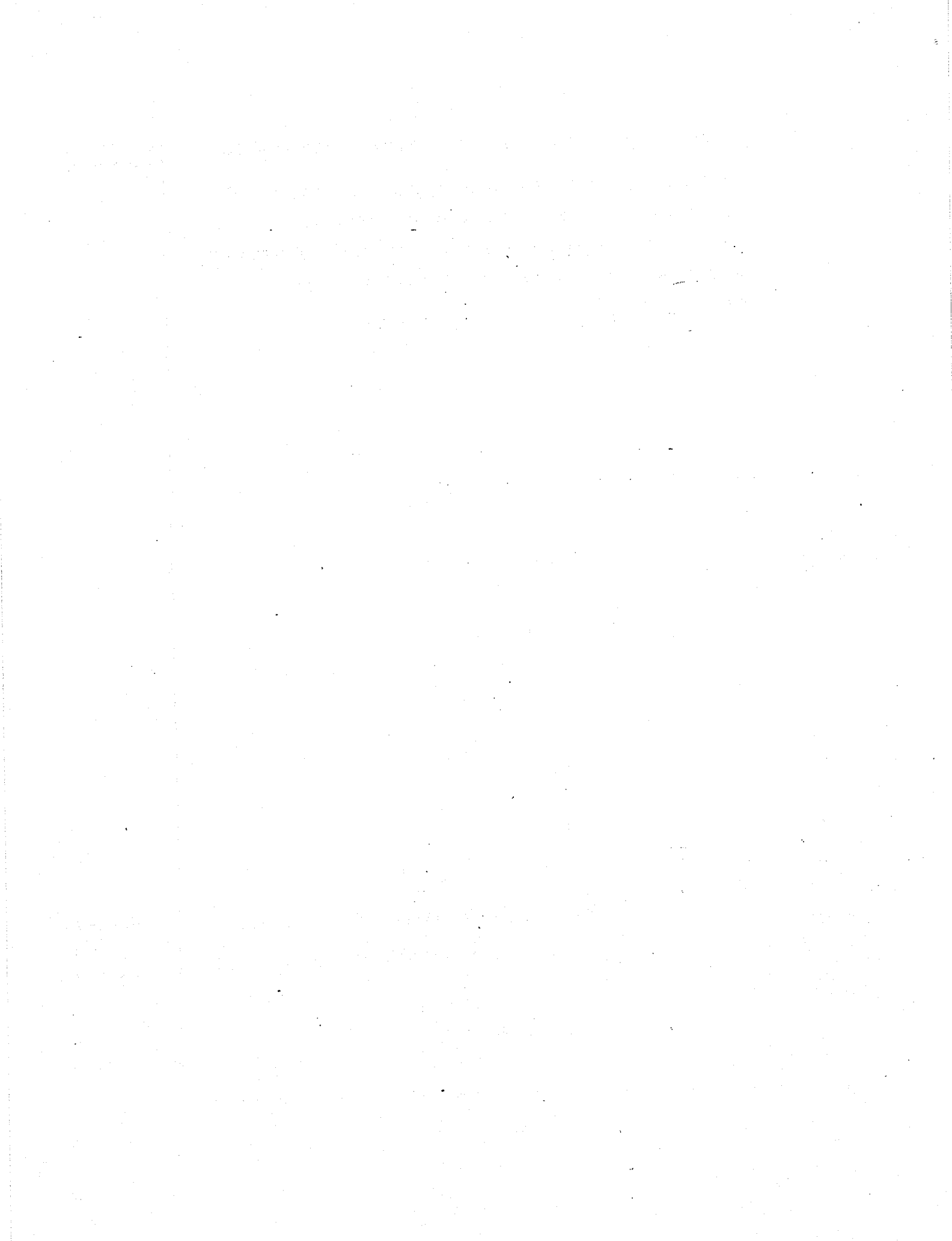

EXAM PAPER 2018(P6)

SCHOOL :NAN HUA

SUBJECT : MATHEMATICS

TERM : CA1

Q1	Q2	Q3	Q4	Q5	Q6	Q7	Q8	Q9	Q10
2	3	4	4	4	4	2	4	1	1
Q11	Q12	Q13	Q14	Q15					
2	3	1	4	1					

16) $2/3 - 4/5 = 2/3 \times 5/4$

$= 5/6$

17) $68/100 - 4 = 17/25$

18) $10.5 - 6.42 = 4.08$

19) $4 - 2/3 \quad 4/1 \times 3/2 = 6$

20) 20

21) $2 \times 2 = 4$

$4 \times 2 = 8$

$8 - 4 = 4\text{cm}^2$

22) $35 \div 7 = 5$

$5 \times 5 = 25$ apples

23)

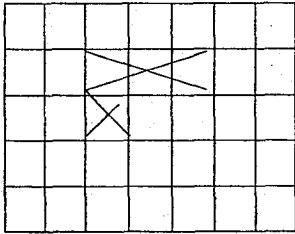

24) 32%

25) $5+10+08+17=40$

$40 \div 5 = 8$

26) $1/20$ m

27) 216cm^2

28) 6 :5

29) 30cm^3

30) a) 400L

b) 1400L

Paper 2

1) $180 \div 20 = 9$

$9 \times 1 = \text{teachers}$

2) $35\% \rightarrow 70$

$1\% \rightarrow 70 \div 35 = 2$

$50\% \rightarrow 2 \times 50 = 100$

3) $10 - 1 = 9$

$\frac{3}{4} \div 9 = 1/12$

4) $80 \div 6 = 13 \text{ R}2$

$13 \times 5 = 65$

$65 + 2 = 67$

5) $2/10 = 1/5$

6)a) $200 + 210 + 150 + 240 = \800

b) $800 + 275 = 1075$

$1075 \div 5 = \$215$

7) $20\% \text{ B} \rightarrow 42 - 38 = 4$

$100\% \text{ B} \rightarrow 4 \times 5 = 20 \text{ boys}$

8)

Twenty- cent	fifty-cent	Total	check \checkmark / \times
$15 \times 0.2 = 3$	$15 \times 0.5 = 7.50$	$7.50 + 3 = 10.50$	\times
$20 \times 0.20 = 4$	$10 \times 0.50 = 5$	$5 + 4 = 9$	\times
$19 \times 0.20 = 3.80$	$11 \times 0.5 = 5.50$	$5.50 + 3.80 = 9.30$	\checkmark

Ans: 19 twenty – cent coins

$$9) 100\% \rightarrow 210$$

$$20\% \rightarrow 210 \div 5 = 42$$

$$80\% \rightarrow 210 - 42 = 168$$

$$70\% \rightarrow 168$$

$$10\% \rightarrow 168 \div 7 = 24$$

$$30\% \rightarrow 24 \times 3 = 72$$

$$72 - 42 = 30 \text{ red balls}$$

$$10)(180^\circ - 58^\circ) \div 2 = 68^\circ$$

$$90^\circ - 68^\circ = 29^\circ$$

$$11) 2R = 74 + 2T + 66$$

$$1R = 37 + 1T + 33$$

$$1R = 3T - 74$$

$$\rightarrow 74 + 144 + 66 = 284$$

$$37 + 1T + 33 = 3T - 74$$

$$37 + 74 + 33 = 3T - 74$$

$$144 = 2T$$

$$72 = 1T$$

$$\text{Left} \rightarrow 2T + 2R$$

$$\rightarrow 144 + 284 = 428$$

$$12) \triangle DFC \rightarrow \frac{1}{2} \times 10 \times 9 = 45$$

$$5/6 \text{ of } ABCD = 25$$

$$1/6 \text{ of } ABCD = 5$$

$$ABCD = 6 \times 5 = 30$$

$$BC = 30 \div 10 = 3 \text{ cm}$$

$$13) \text{ Ben} \rightarrow \frac{1}{3} C + 8$$

$$\text{Alan} \rightarrow \frac{3}{4} R + 2$$

$$\frac{1}{4} R \rightarrow 46 + 2 = 48$$

$$R \rightarrow 48 \times 4 = 192$$

$$\frac{2}{3} C \rightarrow 192 - 8 = 200$$

$$\frac{1}{3} C \rightarrow 200 \div 2 = 100$$

$$C \rightarrow 100 \times 3 = 300 \text{ cards}$$

$$14) 100 - 20 = 80$$

$$20\% \text{ so} \rightarrow 240$$

$$80\% \rightarrow 240 \times 4 = 960$$

$$20\% B \rightarrow 180$$

$$80\% B \rightarrow 180 \times 4 = 720$$

$$720 + 960 = \$1680$$

$$15) 72 \text{ beads}$$

$$16) a) 120\% \rightarrow 150 \text{ ---- } 100\% + 20\%$$

$$100\% \rightarrow 150/120 \times 100 = \$125$$

$$b) 100 - 40 = 60$$

$$60 \div 100 = 0.6$$

$$0.6 \times 70 = 42$$

$$42\% \rightarrow 1.5 \times 42 = \$63$$

$$17) 10u + 100 = 40u - 80$$

$$40u - 10u = 100 + 80$$

$$30u = 180$$

$$1u = 180 \div 30 = 6$$

$$10c \rightarrow 6 \times 2 = 12$$

$$20c \rightarrow 6 \times 5 = 30$$