



**ROSYTH SCHOOL
2019 PRELIMINARY EXAMINATION
MATHEMATICS
PRIMARY 6
PAPER 1**

Name: _____

Register No. _____

Class: Pr 6 - _____

Date: 27 August 2019

Parent's Signature: _____

Total Time for Booklets A and B : 1 hour

BOOKLET A

Instructions to Pupils:

1. Do not open this booklet until you are told to do so.
2. Follow all instructions carefully.
3. Shade your answers in the Optical Answer Sheet (OAS) provided.
4. You are **not** allowed to use a calculator.
5. Answer all questions.

Section	Maximum Mark	Marks Obtained
Paper 1 (Booklet A)	20	

* This booklet consists of 8 pages (including this cover page).

Questions 1 to 10 carry 1 mark each. Questions 11 to 15 carry 2 marks each.
For each question, four options are given. One of them is the correct answer.
Make your choice (1, 2, 3 or 4). Shade the oval (1, 2, 3 or 4) on the Optical Answer Sheet.

All diagrams in this paper are not drawn to scale unless stated otherwise.

(20 marks)

1. Round 263 547 to the nearest hundred.

- (1) 260 000
- (2) 263 500
- (3) 263 550
- (4) 264 000

2.

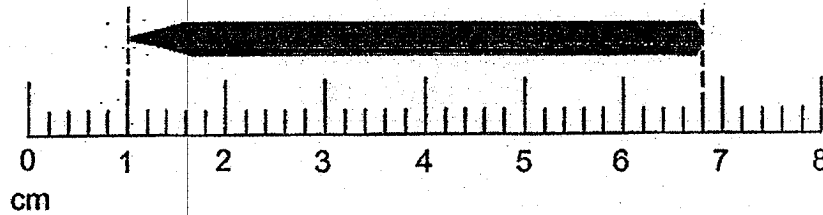

What is the length of the pencil?

- (1) 5.4 cm
- (2) 5.8 cm
- (3) 6.4 cm
- (4) 6.8 cm

3. Find the value of $\frac{5y + 12}{6}$ when $y = 6$.

- (1) 7
- (2) 10
- (3) 17
- (4) 32

4. Troy took 2 h 15 min to bake a cake. He started baking at 11.35 a.m. What time did he finish baking?

- (1) 1.00 p.m.
- (2) 1.15 p.m.
- (3) 1.35 p.m.
- (4) 1.50 p.m.

5. How many letters below have both parallel and perpendicular lines?

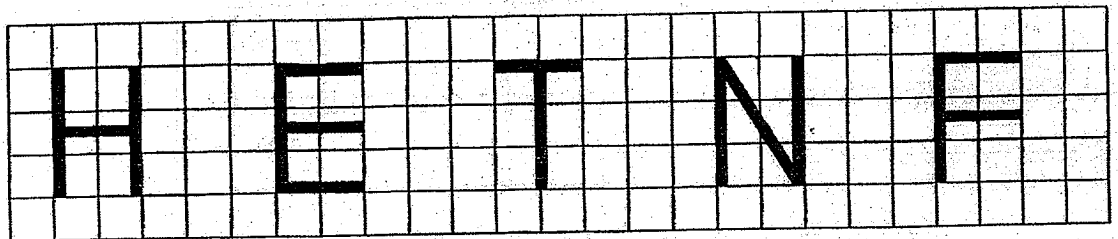

- (1) 5
- (2) 2
- (3) 3
- (4) 4

6. Karen is thinking of a quadrilateral.
 Using the clues below, which of the following shapes, A, B, C, or D is Karen thinking of?
 Clue 1: It has two pairs of parallel sides.
 Clue 2: Not all angles are the same size.
 Clue 3: Not all sides are the same length.

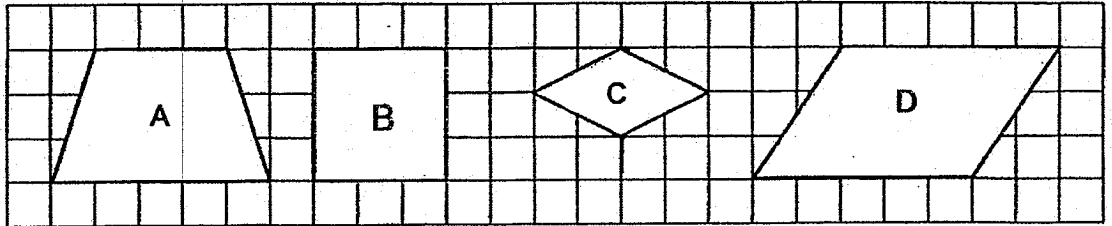

- (1) A
 (2) B
 (3) C
 (4) D
7. The square grid below shows the plan of a town.

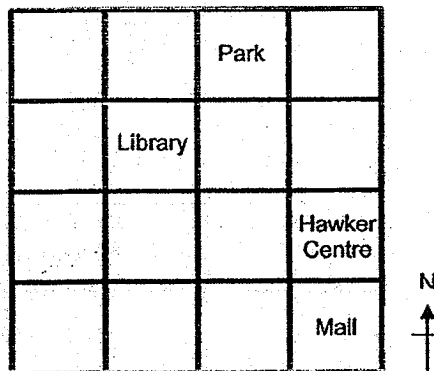

Which direction is the library from the mall?

- (1) North-east
 (2) South-west
 (3) North-west
 (4) South-east

8. A machine can print 80 cards in 3 minutes. At this rate, how many cards can it print in 1 hour?

- (1) 240
- (2) 1 600
- (3) 4 800
- (4) 14 400

9. The figure below shows a pyramid.

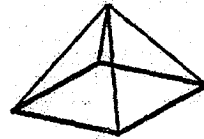

Which of the following is **not** a net of the pyramid?

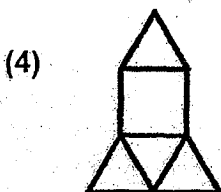
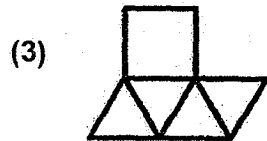
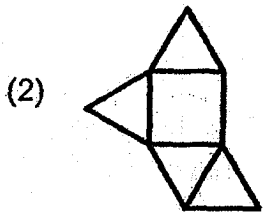
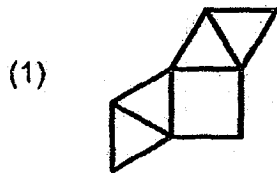

10. The graph shows the number of visitors at the zoo from Monday to Thursday. On which two days were there the same number of visitors at the zoo?

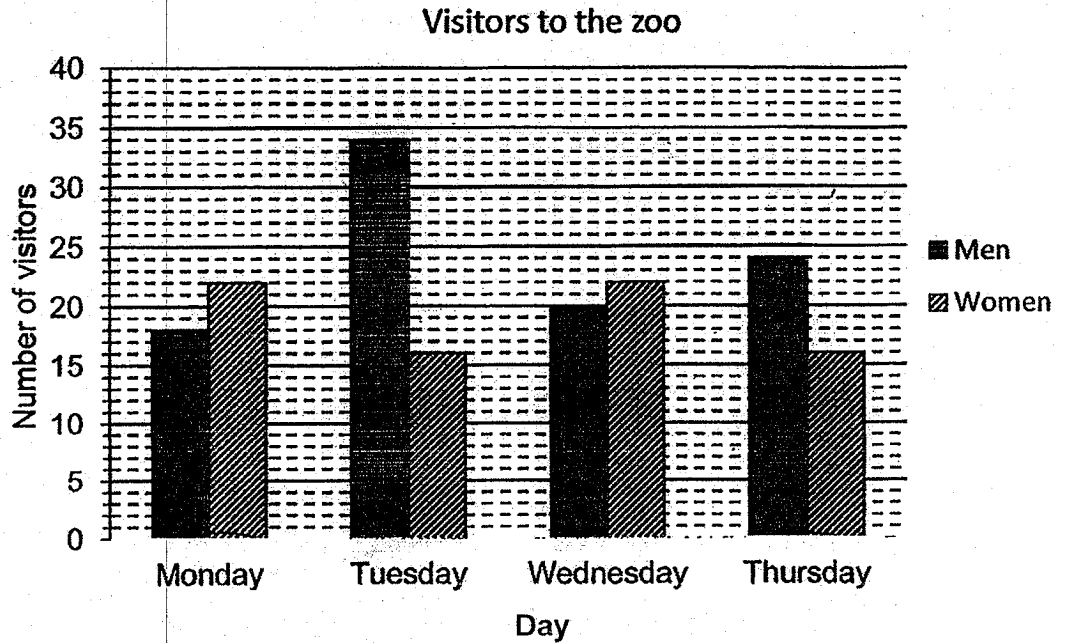

- (1) Monday and Tuesday
- (2) Monday and Thursday
- (3) Wednesday and Thursday
- (4) Tuesday and Thursday
-
11. Andrea had 24 more stamps than Bella. When Bella gave 18 stamps to Andrea, Andrea had 4 times as many stamps as Bella. How many stamps did Bella have at first?
- (1) 14
- (2) 20
- (3) 32
- (4) 38

12. An electronics store sold $\frac{5}{8}$ of their television sets in the morning, $\frac{1}{3}$ of the remaining television sets in the afternoon and the rest of the television sets in the evening. What fraction of the television sets were sold in the evening?

(1) $\frac{1}{4}$

(2) $\frac{2}{3}$

(3) $\frac{1}{24}$

(4) $\frac{5}{24}$

13. The equilateral triangle and the rectangle shown below have the same perimeter. The length of the rectangle is twice its breadth. The side of the triangle is 12 cm. What is the area of the rectangle?

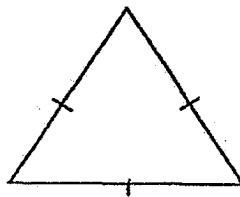

12 cm

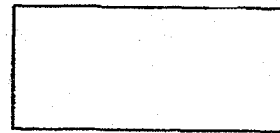

(1) 9 cm^2

(2) 24 cm^2

(3) 72 cm^2

(4) 81 cm^2

14. John, Michael and Terry shared \$27.90 among themselves. Terry received 3 times as much money as Michael and John received twice as much money as Michael. How much money did John receive?

(1) \$3.10

(2) \$4.65

(3) \$6.20

(4) \$9.30

15. Claire bought a bottle containing 2.85 litres of washing detergent. She used 40 ml of washing detergent each day from Monday to Friday. On Saturday and Sunday, she used 50 ml of washing detergent each day. If Claire started using a new bottle on Tuesday, on which day would she use up all the washing detergent?

(1) Monday

(2) Tuesday

(3) Thursday \

(4) Friday



**ROSYTH SCHOOL
2019 PRELIMINARY EXAMINATION
MATHEMATICS
PRIMARY 6
PAPER 1**

Name: _____

Register No. _____

Class: Pr 6 - _____

Group: _____

Date: 27 August 2019

Parent's Signature: _____

Total Time for Booklets A and B : 1 hour

BOOKLET B

Instructions to Pupils:

1. Do not open this booklet until you are told to do so.
2. Follow all instructions carefully.
3. You are **not** allowed to use a calculator.
4. Write your answers in the booklet.
5. Answer all questions.

Section	Maximum Mark	Marks Obtained
Paper 1 (Booklet B)	25	

* This booklet consists of 9 pages (including this cover page).

Questions 16 to 20 carry 1 mark each. Write your answers in the spaces provided. For questions which require units, give your answers in the units stated.

All diagrams in this paper are not drawn to scale unless stated otherwise.

(5 marks)

Do not write
in this space

16. Find the value of $8.2 - 2.33$.

Ans: _____

17. Express 6 minutes as a percentage of 2 hours.

Ans: _____ %

18. In the grid below, draw two straight lines to form a symmetric figure with AB as the line of symmetry.

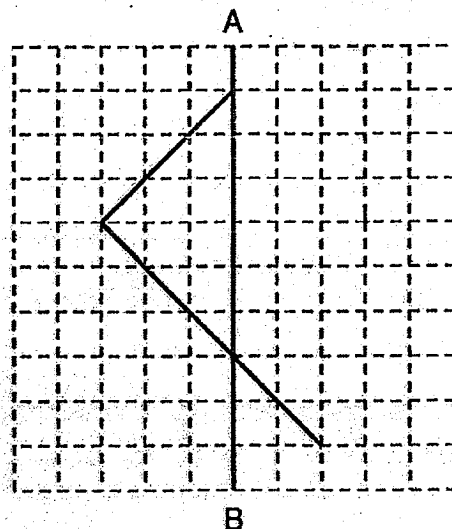

19. A rectangular container measuring 10 cm by 20 cm by 37 cm is $\frac{1}{4}$ filled with water. Find the volume of water in the container.

Do not write in this space

Ans: _____ cm³

20. The pie chart below shows the number of cakes sold at a shop from Tuesday to Friday.

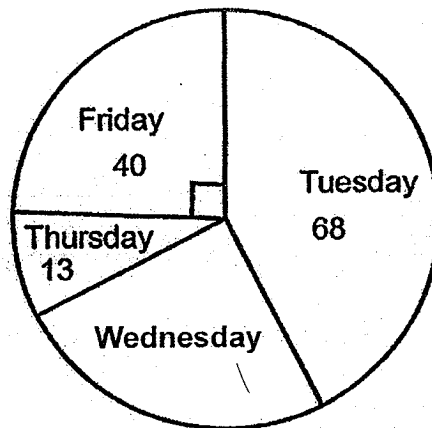

The number of cakes sold from Tuesday to Friday is also represented by the table below. Find the number of cakes sold on Wednesday.

Day	Number of cakes sold
Tuesday	68
Wednesday	?
Thursday	13
Friday	40

Ans: _____

Questions 21 to 30 carry 2 marks each. Show your workings clearly in the space provided for each question and write your answers in the spaces provided. For questions which require units, give your answers in the units stated.

Do not write
in this space

All diagrams in this paper are not drawn to scale unless stated otherwise.
(20 marks)

21. Miss Teo gave her students some sweets. If she gave each student 4 sweets, there were 3 sweets left over. If she gave each student 6 sweets, she was short of 1 sweet. What was the smallest possible number of sweets that Miss Teo gave her students?

Ans: _____

22. The table below shows the marks that Hayden scored for 4 subjects in the SA1 examinations.

Subject	Marks
English	72
Mathematics	65
Mother Tongue	?
Science	80

Hayden scored an average of 72 marks for the 4 subjects. How many marks did he score for his Mother Tongue?

Ans: _____

23. Muthu bought 3 types of stationery items for his office. The prices are given in the table below.

Type of stationery item	Price per item
Pencil	\$0.50
Pen	\$2.00
File	\$4.00

Do not write
in this space

The bar graph shows the total cost spent on each type of stationery items.

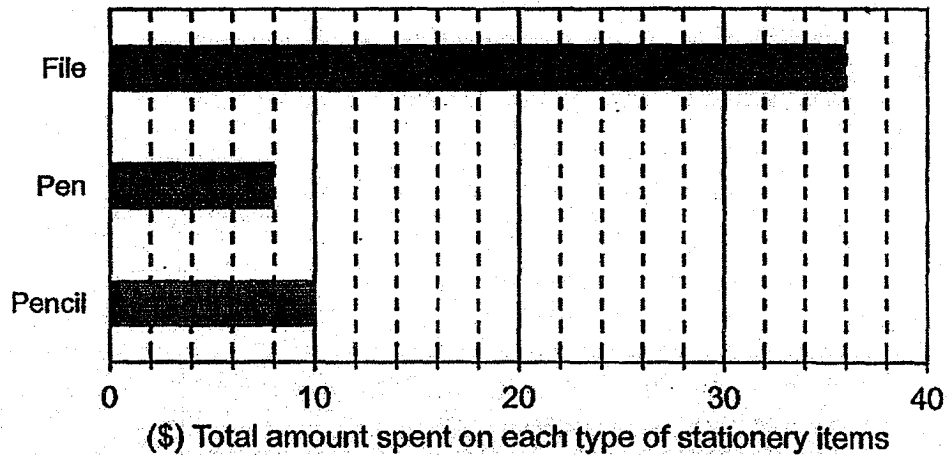

What is the total number of stationery items bought by Muthu?

Ans: _____



24. The figure below is made up of a semi-circle and an equilateral triangle. Find the perimeter of the figure. Take $\pi = \frac{22}{7}$.

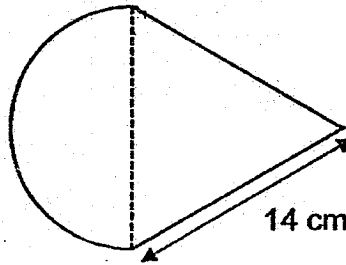

Ans: _____ cm

25. In a 100 m race, when Patrick reached the finishing point, he was 20 m ahead of Raj and 40 m ahead of Salim. All the boys did not change their speed throughout the race. How far had Salim run when Raj reached the finishing point?

Ans: _____ m

Do not write
in this space



26. In the square grid below, XY is a straight line.
 Draw an isosceles triangle XYZ using one of the given points as point Z .

Do not write
 in this space

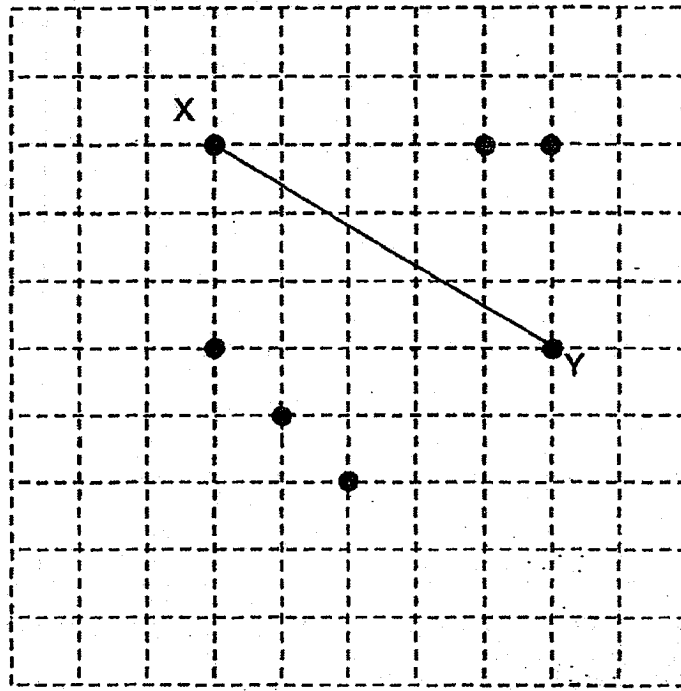

27. A total of 77 people are standing in a queue for concert tickets. There are at least 3 women in between every 2 men. What is the largest possible number of men in the queue?

Ans: _____

28. Mdm Farah baked an equal number of cupcakes and cookies. After she sold 32 cupcakes and 20 cookies, the number of cupcakes left was $\frac{4}{7}$ of the number of cookies left. How many cookies did she bake at first?

Do not write
in this space

Ans: _____

29. In the figure, ABC is an isosceles triangle. $\angle BCD = 220^\circ$ and $\angle ACD = 60^\circ$. Find $\angle BAC$.

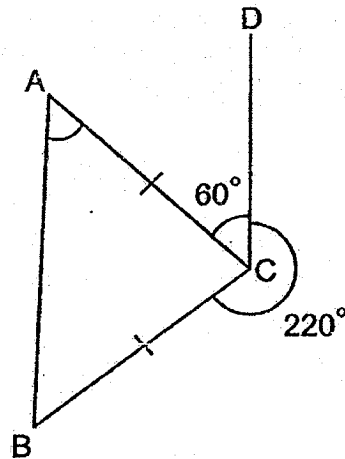

Ans: _____°

30. On Monday, Alynna has \$90 while Rachel has \$10 in each of their savings account. On Tuesday, both Alynna and Rachel start saving a fixed amount daily. Rachel saves \$2 more than Alynna each day. After 10 days Alynna has twice as much money as Rachel. How much does Alynna save each day?

Do not write
in this space

Ans: \$ _____

End of paper

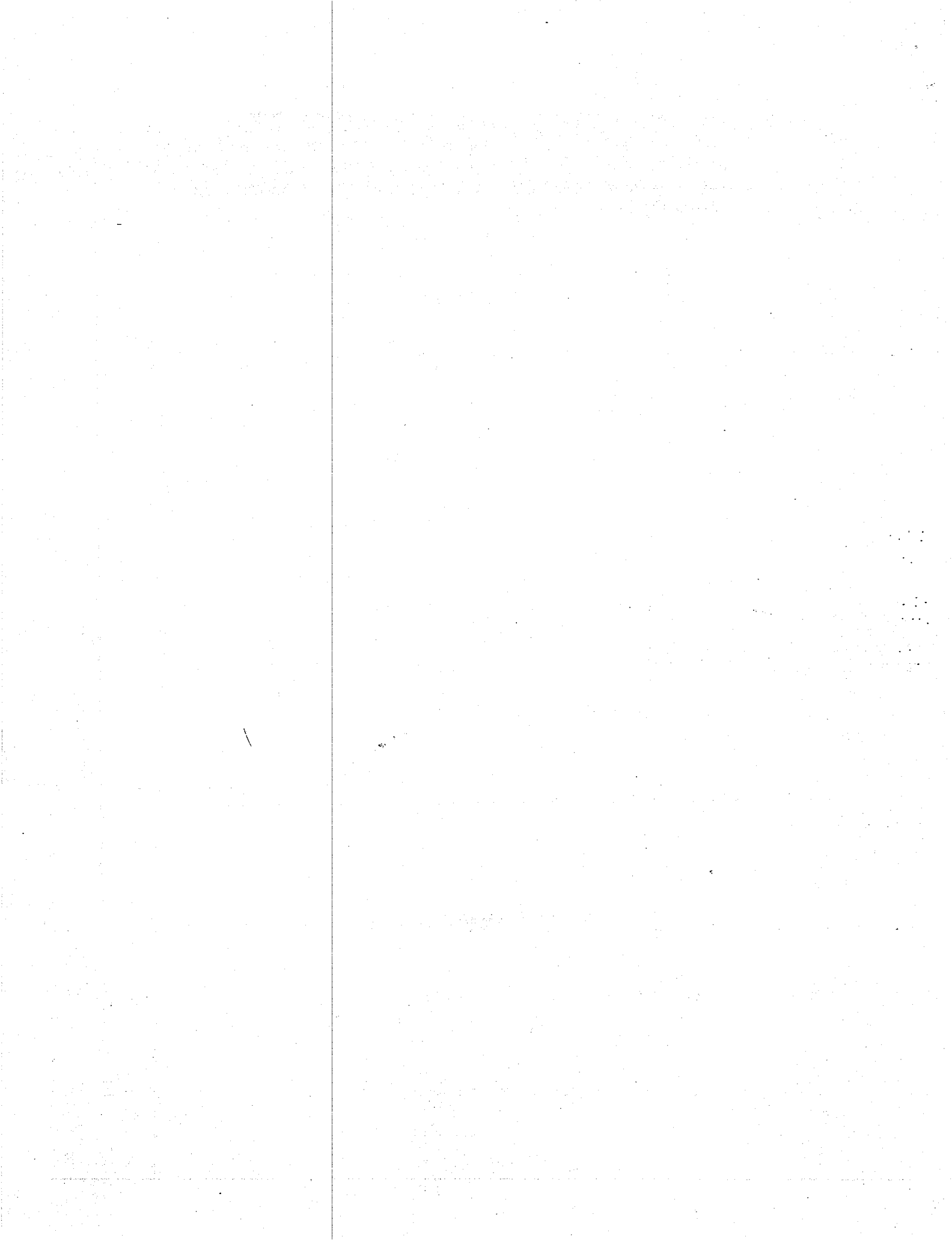



ROSYTH SCHOOL
2019 PRELIMINARY EXAMINATION
MATHEMATICS
PRIMARY 6
PAPER 2

Name: _____ Register No. _____

Class: Pr 6 - _____

Date: 27th August 2019 Parent's Signature: _____

Time: 1h 40mins

Instructions to Pupils:

1. Do not open this booklet until you are told to do so.
2. Follow all instructions carefully.
3. **Show your workings clearly** as marks are awarded for correct working.
4. Write your answers in this booklet.
5. You are allowed to use a calculator.
6. Answer all questions.

Questions	Maximum Mark	Marks Obtained
Q 1 to 5	10	
Q 6 to 18	45	

Section	Maximum Mark	Marks Obtained
Paper 1	45	
Paper 2	55	
Total	100	

* This booklet consists of 15 pages (including this cover page)

Questions 1 to 5 carry 2 marks each. Show your working clearly in the space provided for each question and write your answers in the spaces provided. For questions which require units, give your answers in the units stated.

(10 marks)

Do not write
in this space

All diagrams in this paper are not drawn to scale unless stated otherwise.

1. Joel had 6p marbles. He had half as many marbles as Amanda. Amanda had 8 more marbles than Raju. How many marbles did they have altogether?

Ans: _____

2. James has $\frac{1}{4}$ as many sweets as Ahmad and $\frac{4}{5}$ as many sweets as Muthu. They have a total of 325 sweets. How many sweets does Muthu have?

Ans: _____

3. Two identical triangles overlapped each other to form six smaller identical equilateral triangles as shown below. The area of the shaded part is 78 cm^2 . Find the area of 1 unshaded equilateral triangle.

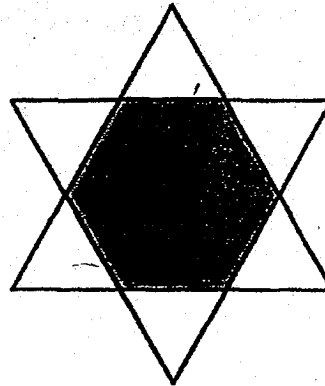

Do not write
in this space

Ans: _____ cm^2

4. In an examination hall, the tables were arranged in such a way that there were 15 rows with 30 tables in each row on Day 1. On Day 2, 8 tables were removed from each row and the remaining tables were then rearranged such that there were 33 tables in each row.

Statement	True	False	Not possible to tell
a) There were 442 tables left on Day 2.			
b) There were 10 rows of tables on Day 2.			

5. A rectangular tank was filled with some water at first. Tap A was first turned on to add more water into the tank for 20 minutes. After 10 minutes, Tap B was then turned on to drain water out of the tank until the 20th minute. The line graph shows the volume of water in the tank over the period of 20 minutes.

Do not write
in this space

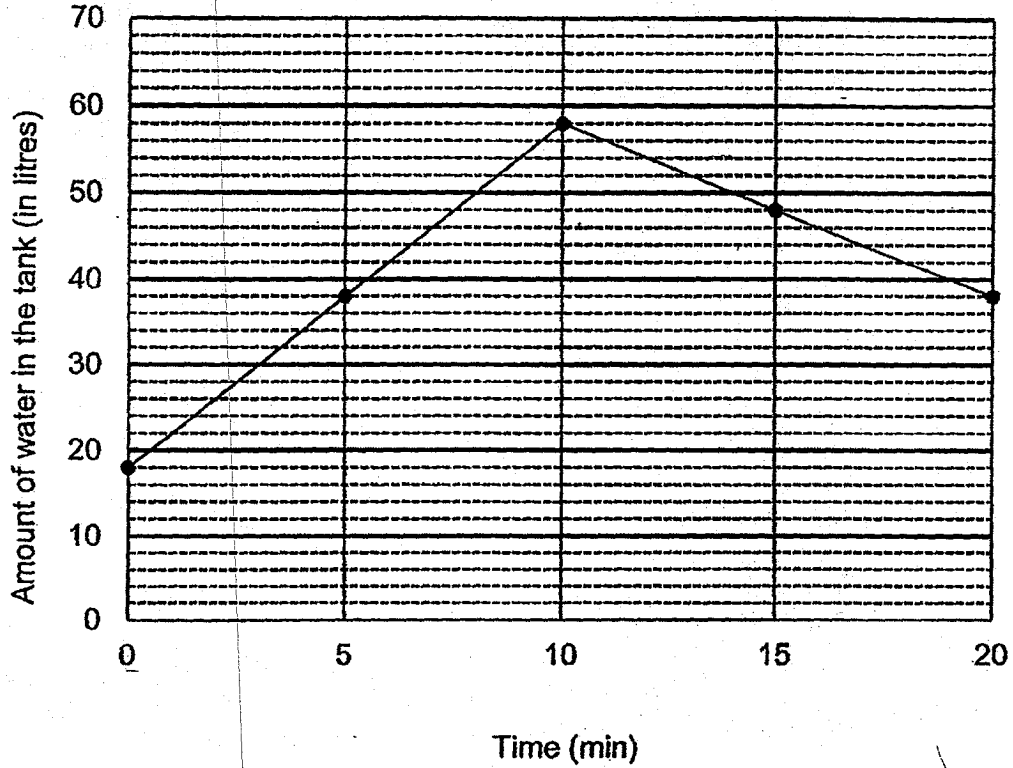

How many litres of water did Tap B drain out?

Ans: _____ l

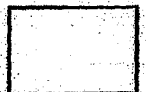

For Questions 6 to 18, show your working clearly in the space provided for each question and write your answers in the spaces provided. The number of marks available is shown in brackets [] at the end of each question or part-question. For questions which require units, give your answers in the units stated.

Do not write
in this space

All diagrams in this paper are not drawn to scale unless stated otherwise.
(50 marks)

6. $\frac{1}{3}$ of Julie's money was equal to $\frac{3}{5}$ of Nancy's money. After Julie gave Nancy \$42, both of them would have the same amount of money. How much money did Nancy have at first?

Ans: _____ [3]

7. Andy had just enough ribbon to cut into 45 shorter pieces of equal length. However, if he cut the ribbon into 37 pieces of equal length, he would have 5.04 m of ribbon left. What was the length of ribbon?

Ans: _____ [3]

8. Tony wants to sell a laptop. The table shows the prices of the same laptop from his shop and Shop Y.

Do not write
in this space

Tony's shop		Shop Y	
Original Price	% Discount	Original Price	% Discount
\$ 3 500	?	\$4 000	30%

Tony wants to price his laptop at the same selling price as Shop Y. How much percentage discount must he give to match Shop Y's selling price?

Ans: _____ [3]



9. Alfred left his house for Zain's house. Alfred wants to reach Zain's house at 6.00 p.m. If Alfred walks at a speed of 60 m/min, he will be 16 minutes late. If he jogs at a speed of 80 m/min, he will be 6 minutes late. What is the distance between Alfred's and Zain's house?

Do not write
in this space

Ans: _____ [3]



10. In the diagram below, PQS is an equilateral triangle. QT is a straight line. $PR \perp QS$, $\angle PQV = 35^\circ$ and $\angle PST = 75^\circ$. Find

- (a) $\angle QPR$
 (b) $\angle QTS$

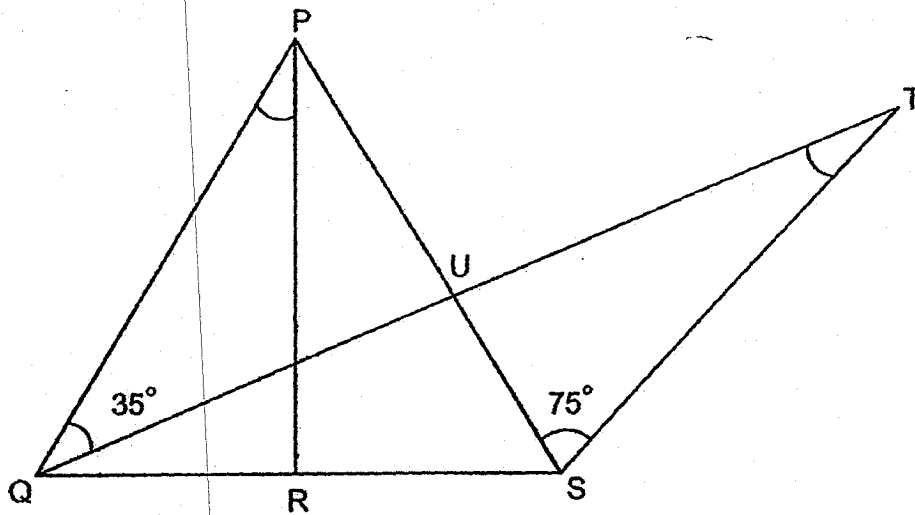

Do not write
in this space

Ans: (a) _____ [1]

(b) _____ [2]



11. The figure consists of 2 identical rectangles, ABCD and EFGH, overlapping one another. Both WXYZ and EBCH are squares. The area of each rectangle is 306 cm^2 . 40% of the whole figure is shaded. The unshaded area of the whole figure is 324 cm^2 . What is the ratio of the area of triangle EXH to the area of ADGF?

Do not write in this space

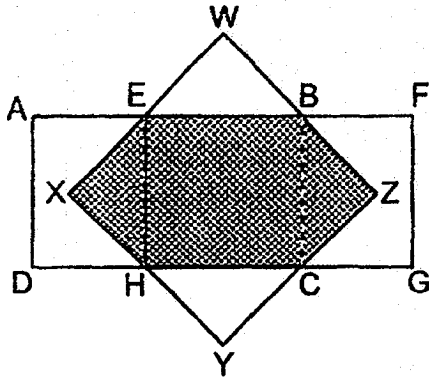

Ans: _____ [4]



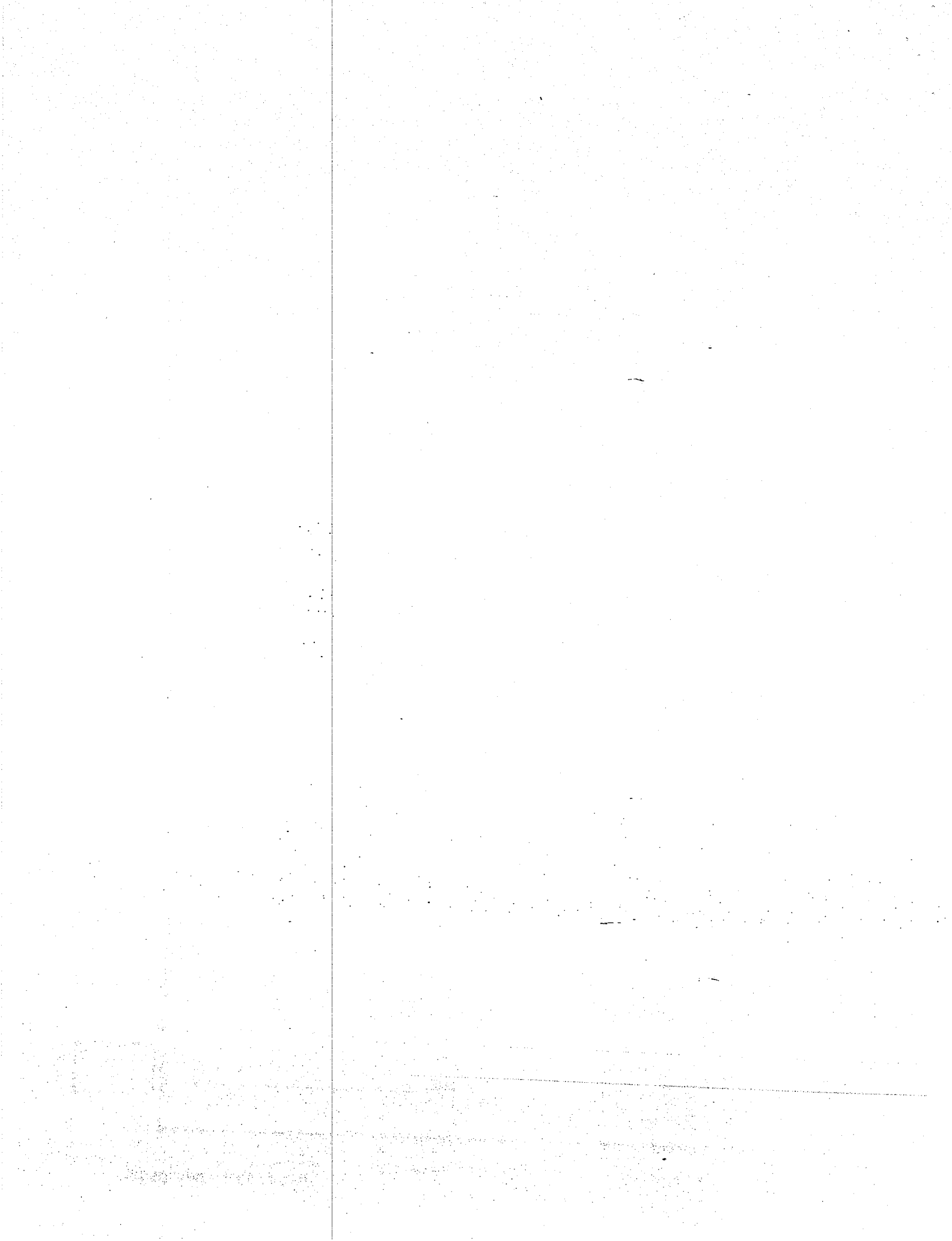

11. The figure consists of 2 identical rectangles, ABCD and EFGH, overlapping one another. EBCH is a square. The area of each rectangle is 280 cm^2 . 40% of the whole figure is shaded. The unshaded area of the whole figure is 360 cm^2 . What is the ratio of triangle EXH to the area of ADGF?

Do not write
in this spac

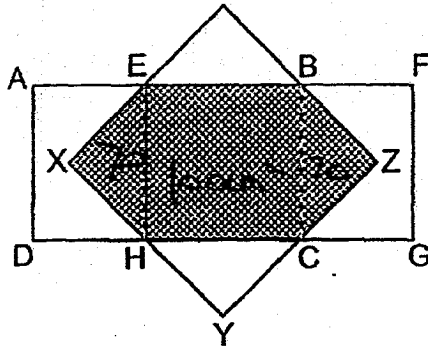

Ans: _____ [4]

12. The number of visitors to a zoo was 152 880 in July. This was a 16% decrease from the number in June. The number of people who visited the zoo in August was a 20% increase from the number in July.

- (a) What was the total number of people who visited the zoo in June?
- (b) What was the percentage increase in the number of people who visited the zoo in August compared to June?

Do not write
in this space

Ans: (a) _____ [2]

(b) _____ [2]

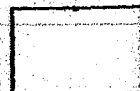

13. The diagram below shows 2 tanks Tank A and Tank B of different dimensions. Tank A is completely empty while Tank B is filled with water to the brim.

Do not write in this space

(a) Find the volume of water in Tank B.

(b) Water from Tap A flows at a rate of 2.7 litres per minute while water drains from Tap B at a rate of 2.4 litres per minute. Both taps are turned on at the same time. After some time, the height of the water level in both tanks becomes the same. Find the height of the water level at this point of time.

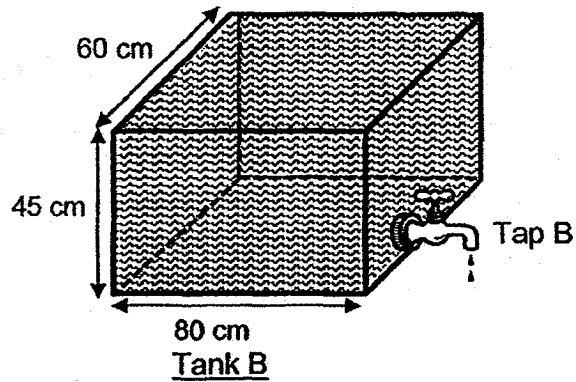
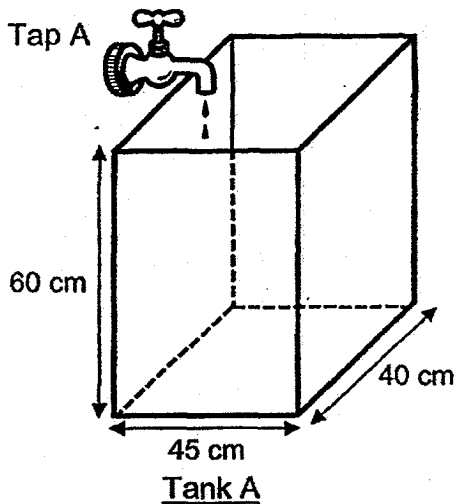

Ans: (a) _____ [1]

(b) _____ [3]



14. In the figure, ABDE is a trapezium and $AC \parallel ED$. Find

(a) $\angle CFE$

(b) $\angle FED$

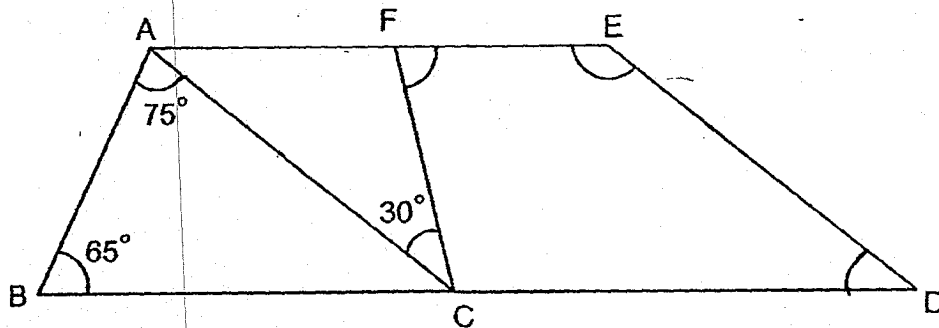

Do not write
in this space

Ans: (a) _____ [2]

(b) _____ [2]



15. Mrs Raju wanted to decorate the bulletin board with some circular pieces of paper. The diameter of each circular paper was 12 cm. She cut all the circular pieces of paper into quadrants and decorated the entire bulletin board using all the quadrants, following the pattern shown below. There was no gap between each piece of quadrant.

Do not write in this space

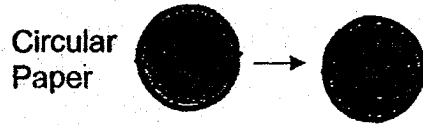

How many pieces of circular paper did she use to decorate the bulletin board?

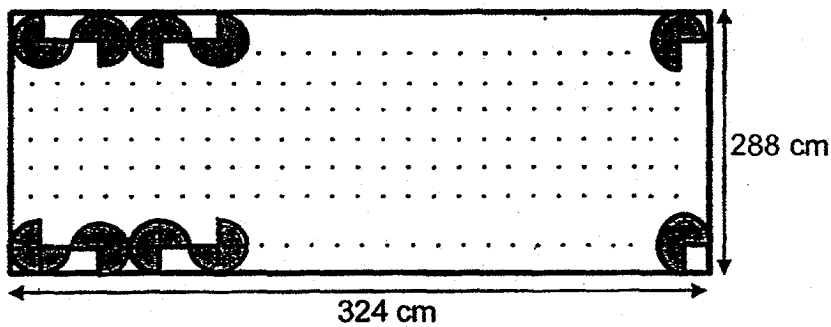

Ans: _____ [4]

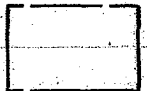

Do not write
in this space

16. There were 200 more apples than pears at a fruit stall. After $\frac{1}{4}$ of the apples and $\frac{2}{7}$ of the pears were sold, there were 170 more apples than pears left.

(a) How many apples were there at the fruit stall at first?

(b) How many pears were left at the fruit stall in the end?

Ans: (a) _____ [3]

(b) _____ [2]

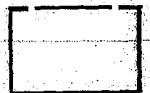

17. A chef prepared some fishballs for the guests during a birthday party. 60% of the guests were children. Among the children, the ratio of the number of girls to the number of boys is 5 : 3. A total of 9 408 fishballs were prepared so that each adult got 5 fishballs and each child got 6 fishballs. There were no fishballs left after the party.

Do not write
in this space

a) What was the ratio of the number of fishballs the adults got to the number of fishballs the children got?
Give your answer in the simplest form.

b) How many boys attended the party?

Ans: (a) _____ [3]

(b) _____ [2]



End of Paper

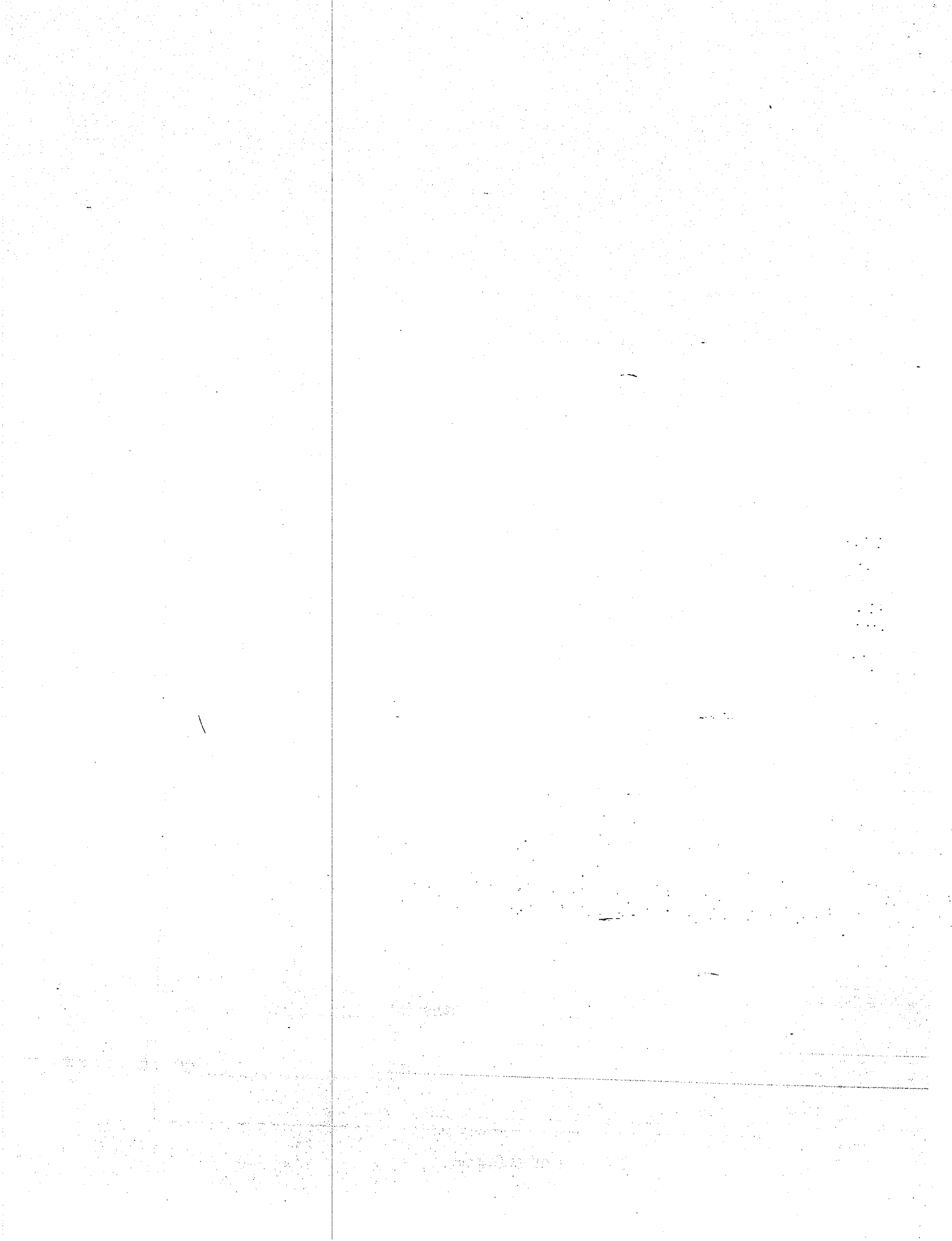

SCHOOL : ROSYTH PRIMARY SCHOOL
 LEVEL : PRIMARY 6
 SUBJECT : MATH
 TERM : 2019 PRELIM

PAPER 1 BOOKLET A

Q 1	Q2	Q3	Q4	Q5	Q6	Q7	Q8	Q9	Q10
2	2	1	4	3	4	3	2	3	2

Q 11	Q12	Q13	Q14	Q15
4	1	3	4	4

PAPER 1 BOOKLET B

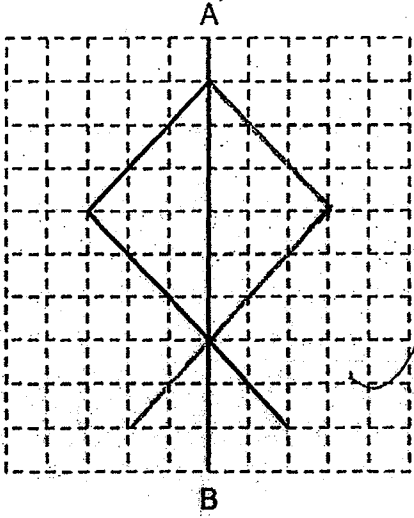
Q16)	5.87
Q17)	5%
Q18)	
Q19)	1850cm ³
Q20)	39

Q21)	$6 - 4 = 2$ $3 + 1 = 4$ $4 \div 2 = 2$ $2 \times 4 = 8$ $8 + 3 = 11$ sweets
Q22)	$72 \times 4 = 288$ $288 - 72 = 216$ $216 - 65 = 151$ $151 - 80 = 71$ marks
Q23)	$36 \div 4 = 9$ $8 \div 2 = 4$ $10 \div 0.50 = 20$ $9 + 4 + 20 = 33$
Q24)	$\frac{1}{2} \times \frac{22}{7} \times 14 = \frac{22}{7} \times 7 = 22$ $22 + 14 + 14 = 22 + 28 = 50$ cm
Q25)	$80 : 60$ $4 : 3$ $100 : 75\text{m}$
Q26)	
Q27)	$77 \div 4 = 19\text{R}1$ $19 \times 1 = 19$ $19 + 1 = 20$ men
Q28)	48 cookies
Q29)	50°
Q30)	\$3

PAPER 2

Q1)	Joel ---6p Amanda---12p Rajv --- 12p - 8 $6p + 12p + 12p - 8 = (30p - 8)$ marbles
Q2)	$25u = 325$ $1u = 325 \div 25 = 13$ $5u = 13 \times 5 = 65$ sweets
Q3)	$6u = 78$ $1u = 78 \div 6 = 13$ cm ²
Q4)	a)False b)True
Q5)	$38 - 18 = 20$ 5 mins --- 20 10 mins--- $20 \times 2 = 40$ $58 + 40 = 98$ $98 - 38 = 60$ L
Q6)	$\frac{1}{3} J = \frac{3}{5} N$ $\frac{3}{9} J = \frac{3}{5} N$ $42 \times 2 = 84$ $9u - 5u = 4u$ $4u = 84$ $1u = 84 \div 4 = 21$ $5u = 21 \times 5 = \$105$
Q7)	$45 - 37 = 8$ 8 pieces $\rightarrow 5.04$ m 1 piece $\rightarrow 5.04\text{m} \div 8 = 0.63$ m 45 pieces $\rightarrow 0.63\text{m} \times 45 = 28.35$ m
Q8)	$\frac{7}{10} \times 4000 = 2800$ $3500 - 2800 = 700$ $\frac{700}{3500} \times 100\% = 20\%$

Q9)	$60u + 600 = 80u$ $20u = 600$ $1u = 600 \div 20 = 30$ $30 \times 80 = 2400m$
Q10)	a) $\angle TQS = 60 - 35 = 25$ $\angle QVR = 90 - 25 = 65$ $\angle PVQ = (360 - 65 - 65) \div 2 = 115$ $\angle QPR = 180 - 35 - 115 = 30^\circ$ b) $\angle QTS = 180 - 25 - 60 - 75 = 20^\circ$
Q11)	60% $\rightarrow 324$ 10% $\rightarrow 324 \div 6 = 54$ 100% $\rightarrow 54 \times 10 = 540$ 40% $\rightarrow 54 \times 4 = 216$ $216 \div 6 = 36$ $36 \times 4 = 144$ $144 + 324 = 468$ $36 : 468 = 1 : 13$
Q12)	a) 84% $\rightarrow 152880$ 1% $\rightarrow 152880 \div 84 = 1820$ 100% $\rightarrow 1820 \times 100 = 182000$ (June) b) $\frac{12}{10} \times 152880 = 183456$ (August) $183456 - 182000 = 1456$ $\frac{1456}{182000} \times 100\% = 0.8\%$
Q13)	a) $80 \times 60 \times 45 = 216000$ b) $33\frac{3}{4}$
Q14)	a) $\angle ACB = 180 - 75 - 65 = 40$ $\angle FAC = 180 - 65 - 75 = 40$ $\angle AFC = 180 - 40 - 30 = 110$ $\angle CFE = 180 - 110 = 70^\circ$ b) $\angle FED = 180 - 40 = 140^\circ$
Q15)	$288 \div 12 = 24$ $324 \div 12 = 27$ $27 \times 24 = 648$ $648 \div 4 \times 3 = 488$

Q16)	a)760 b)400
Q17)	a)5: 9 b)378 boys

