



HENRY PARK PRIMARY SCHOOL
FIRST SEMESTRAL ASSESSMENT 2019

PRIMARY 6

SCIENCE

BOOKLET A (56 MARKS)

INSTRUCTIONS TO CANDIDATES

1. Do not turn over this page until you are told to do so.
2. Follow all instructions carefully.
3. Answer all questions.
4. Shade your answers on the Optical Answer Sheet (OAS) provided.

Name: _____ ()

Class: Primary 6 ()

Date: 22 May 2019

Total Time: 1 h 45 min

Booklet	Marks	
A		/ 56
B		/ 44
Total (A+B)		/ 100

Parent's Signature: _____

Booklet A (56 marks)

For each question from 1 to 28, four options are given. One of them is the correct answer. Make your choice (1, 2, 3 or 4). Shade the correct oval (1, 2, 3 or 4) on the **Optical Answer Sheet**.

1. Study the organisms shown below.

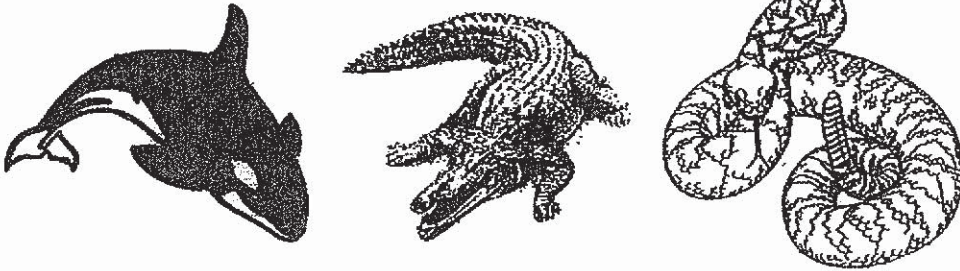

Which characteristic(s) do all three animals have in common?

- A: lay eggs
- B: have lungs
- C: have scaly skin
- D: give birth to their young alive

- (1) A only
- (2) B only
- (3) A and C only
- (4) B and D only



2. Amery conducted an experiment on photosynthesis in a dark room using the set-up below. She measured the amount of gas collected in the measuring cylinder after some time.

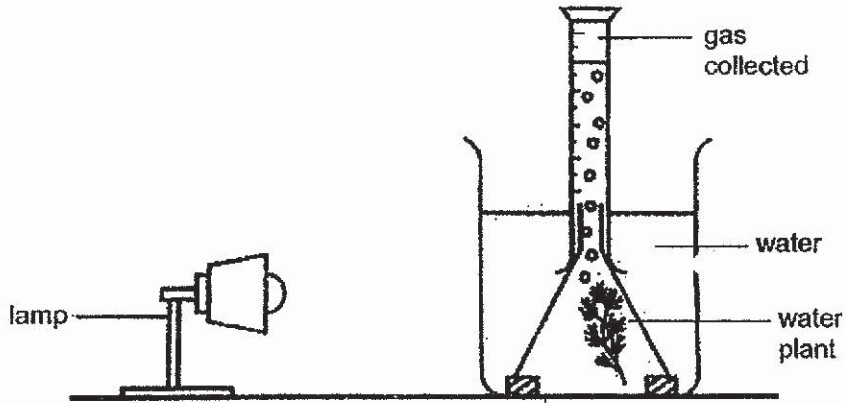

The graphs below show the amount of gas collected plotted against different variables.

Which of the following graphs shows the correct amount of gas collected?

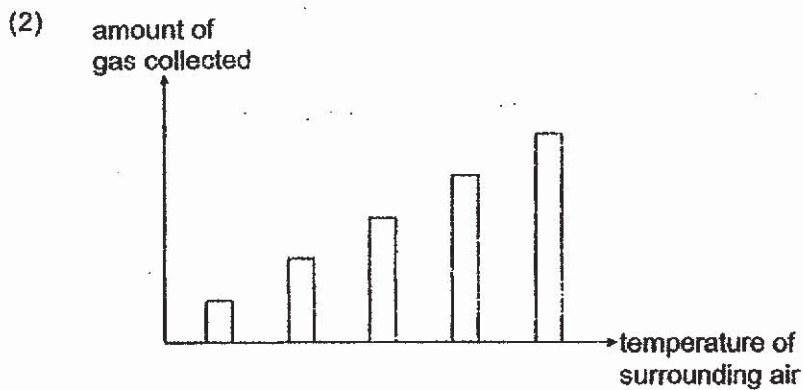
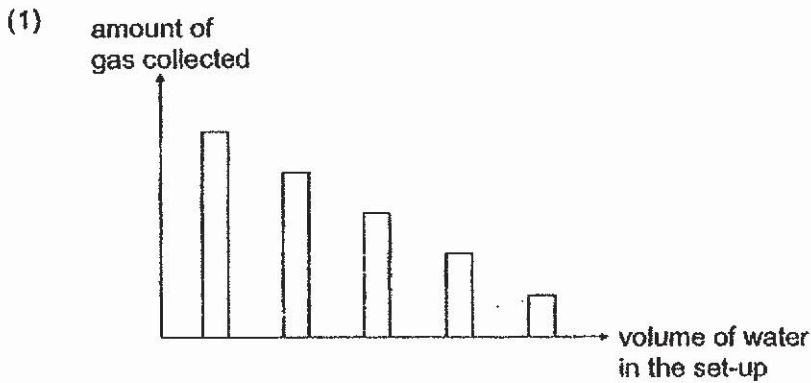

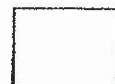
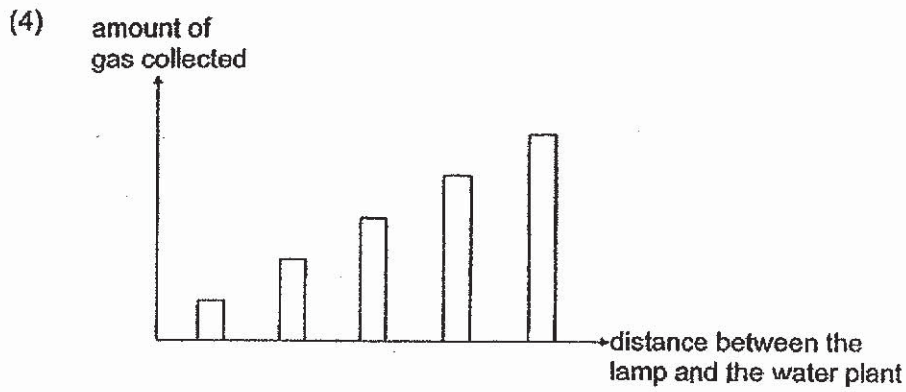
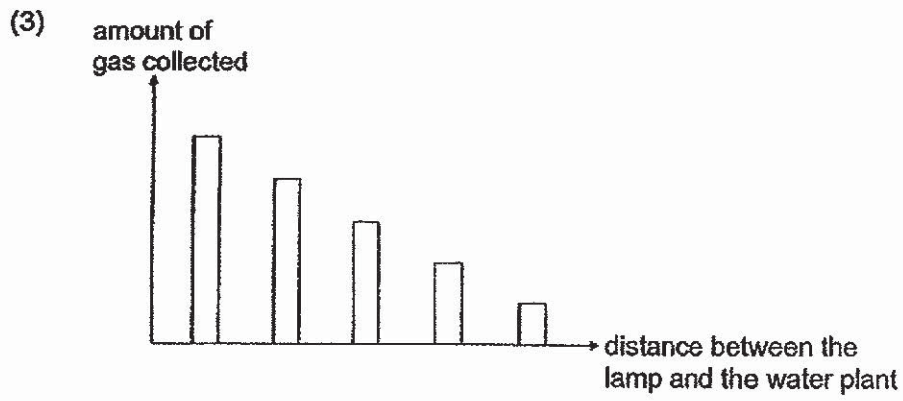

3. The diagram below shows the human digestive system.

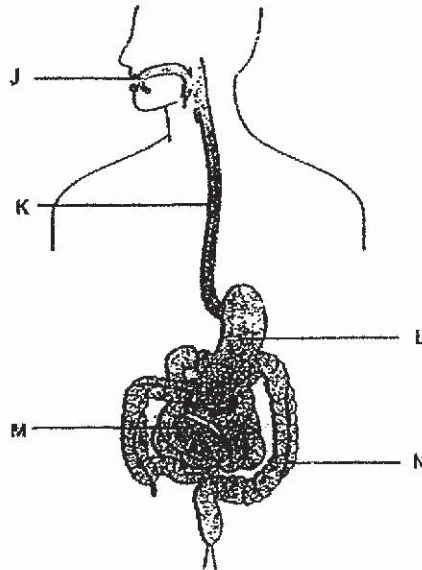

Where does digestion take place?

- (1) J, K and L only
- (2) J, L and M only
- (3) K, L and M only
- (4) L, M and N only



4. The diagram shows Peter's family tree. The members of the family are either tongue rollers or non-tongue rollers.

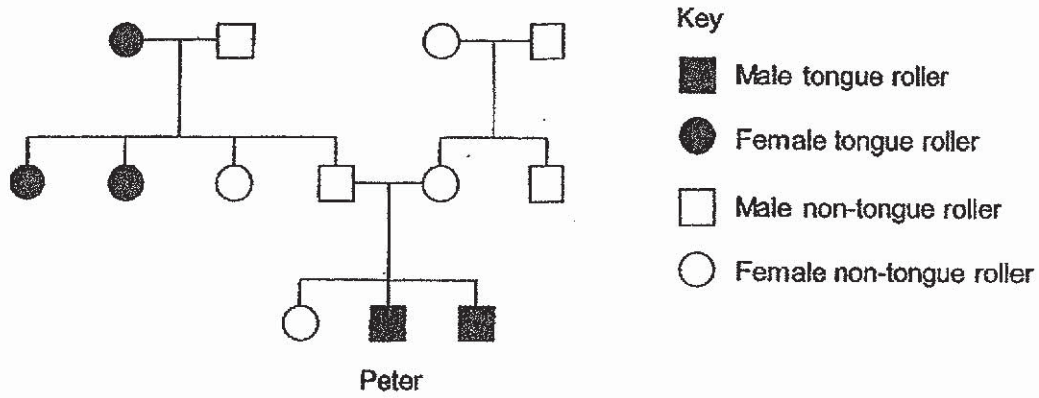

Key

- Male tongue roller
- Female tongue roller
- Male non-tongue roller
- Female non-tongue roller

Which one of the following statements about the family tree is correct?

- (1) Peter's parents are tongue rollers.
- (2) Peter and his siblings are all tongue-rollers.
- (3) Both Peter's grandfathers are tongue rollers.
- (4) Peter's father has a sister who is a non-tongue roller.

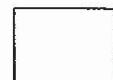

5. Julia conducted an experiment to find out whether oxygen is needed for the germination of seeds.

Which of the following set-ups are the most suitable for conducting a fair test?

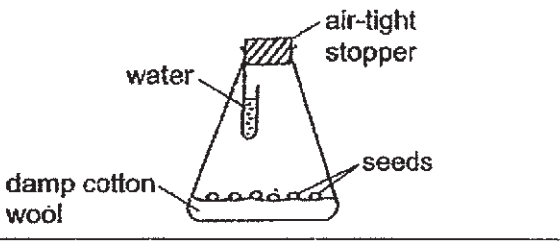
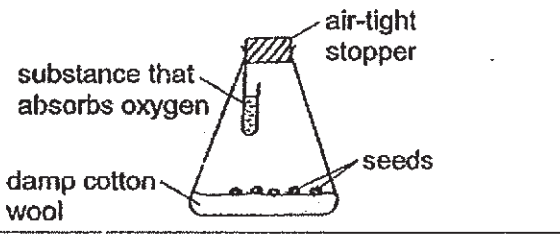
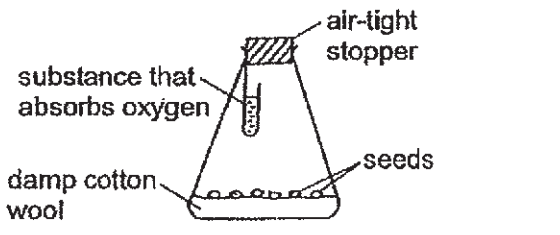
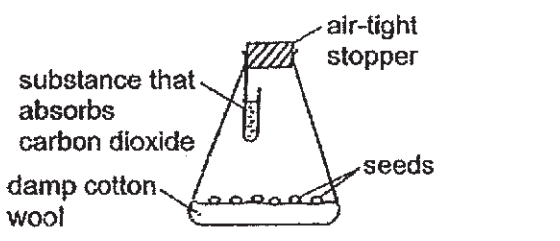
A	 <p>air-tight stopper water seeds damp cotton wool</p>
B	 <p>air-tight stopper substance that absorbs oxygen seeds damp cotton wool</p>
C	 <p>air-tight stopper substance that absorbs oxygen seeds damp cotton wool</p>
D	 <p>air-tight stopper substance that absorbs carbon dioxide seeds damp cotton wool</p>

(1) A and B only

(2) A and C only

(3) A and D only

(4) C and D only



6. The diagram shows the life cycle of a flowering plant.

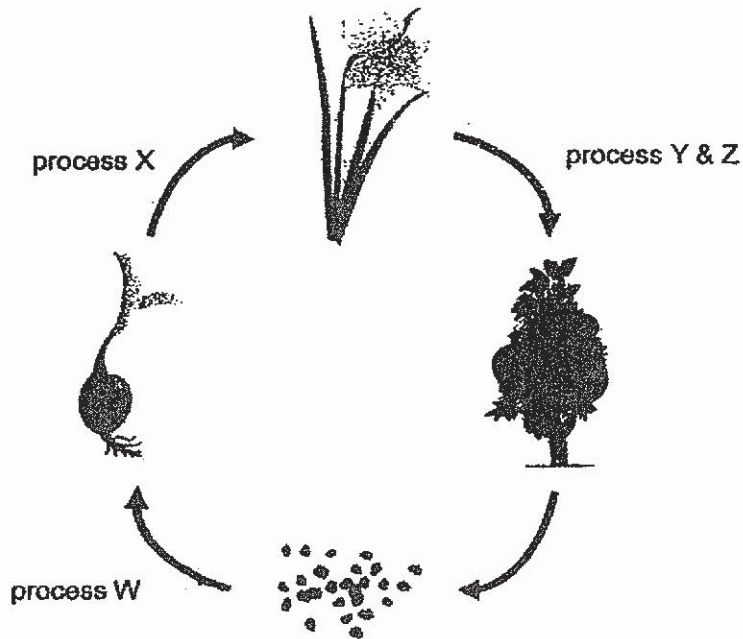

Which of the process(es) would be able to take place if light is not present?

- (1) W only
- (2) Y and Z only
- (3) W and X only
- (4) X, Y and Z only



7. Joel wanted to know how the amount of oxygen and carbon dioxide changes inside a sealed container as the plant is left under the sun. Using his results from the experiment, he plotted the graph below.

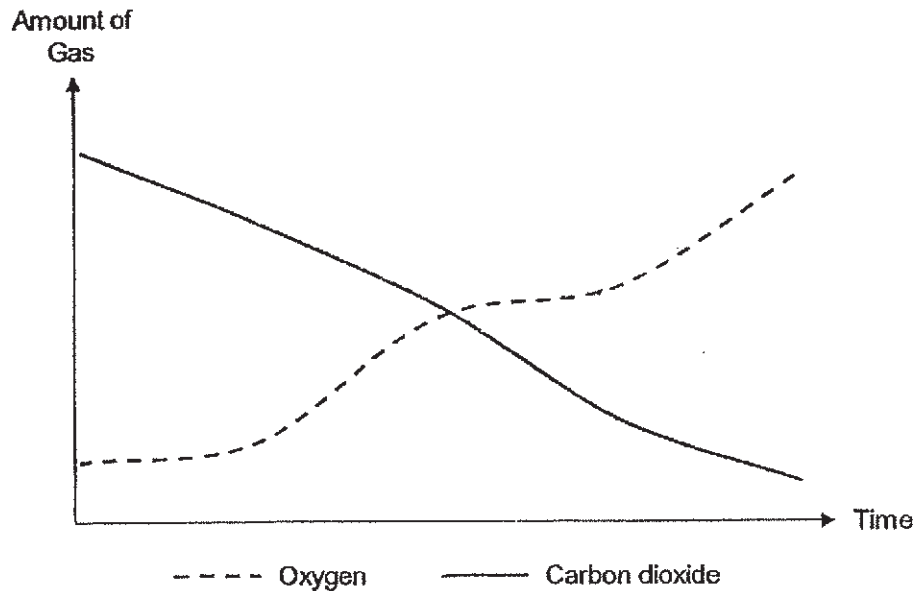

Which set-up best describes the material of the container and the soil used in the experiment?

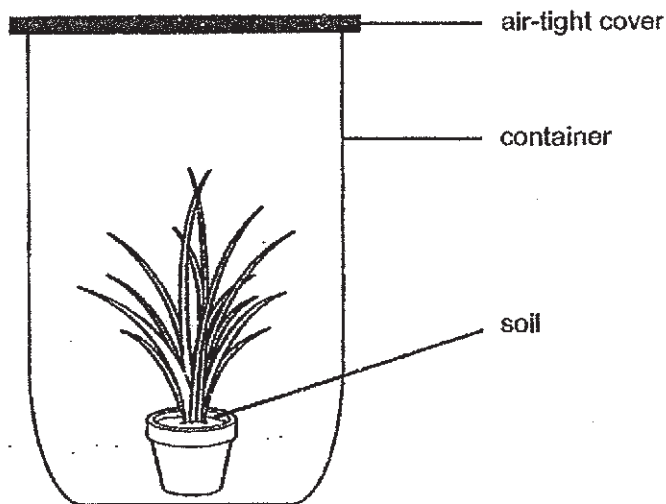

	soil	container
(1)	moist	clear glass
(2)	moist	ceramic
(3)	dry	ceramic
(4)	dry	clear glass



8. Zoe released several fish into a fish tank as shown below.

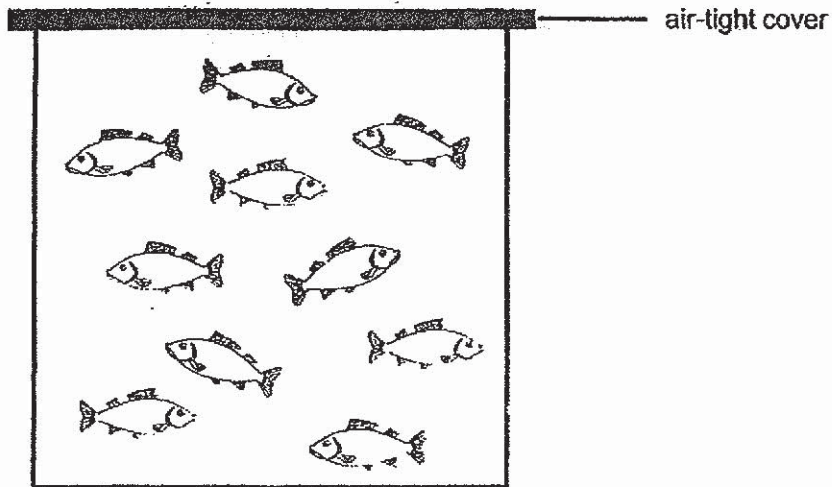

She fed the fish and observed them daily. She then noticed that the number of live fish in the tank decreased as the days passed.

She stated the following reasons to explain the decreasing number of fish in the tank.

- A: There was insufficient water in the tank.
- B: There was insufficient space in the tank.
- C: There was insufficient food in the water in the tank.
- D: There was insufficient oxygen in the water in the tank.

Which of the statement(s) is/are correct?

- (1) C only
- (2) D only
- (3) A, B and D only
- (4) A, B, C and D

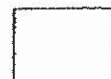

9. Which of the following action(s) does/do not contribute to water pollution directly?

- A: burning of fossil fuel for electricity
- B: release of sewage into water bodies
- C: excessive use of fertilisers during planting of crops

- (1) A only
- (2) A and C only
- (3) B and C only
- (4) A, B and C

10. Adrienne wanted to know how the different parts of the plant affect the ability of the plant to make food. She removed different plant parts from each plant. She then placed the pots of plants in the garden where there was plenty of sunlight and watered them regularly with the same amount of water.

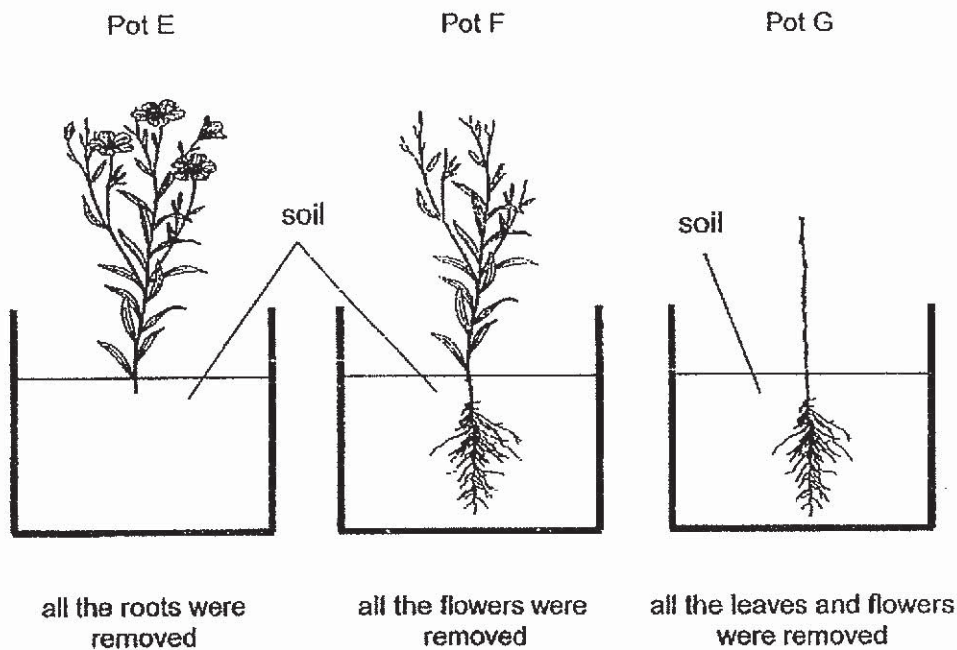

Which of the following pots of plants died after a week if the removed parts did not regrow?

- (1) E and F
- (2) E and G
- (3) F and G
- (4) E, F and G

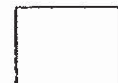

11. A large amount of fertiliser from a farm flows into a nearby river at point G. The arrow shows the direction in which the river flows.

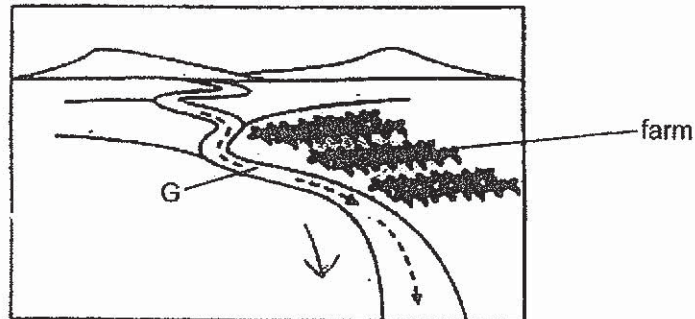

After some time, fully-submerged water plants living in the river after point G died.

The graph below represents the effect of fertiliser entering the river at G.

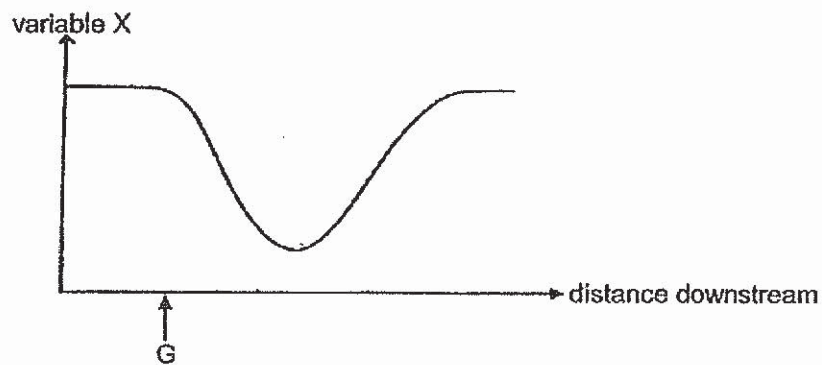

What could variable X be?

- (1) amount of floating plants
- (2) amount of oxygen in water
- (3) amount of bacteria in water
- (4) amount of nutrients in water



12. The graph below shows the effect of temperature on the number of organisms P, Q, R and S.

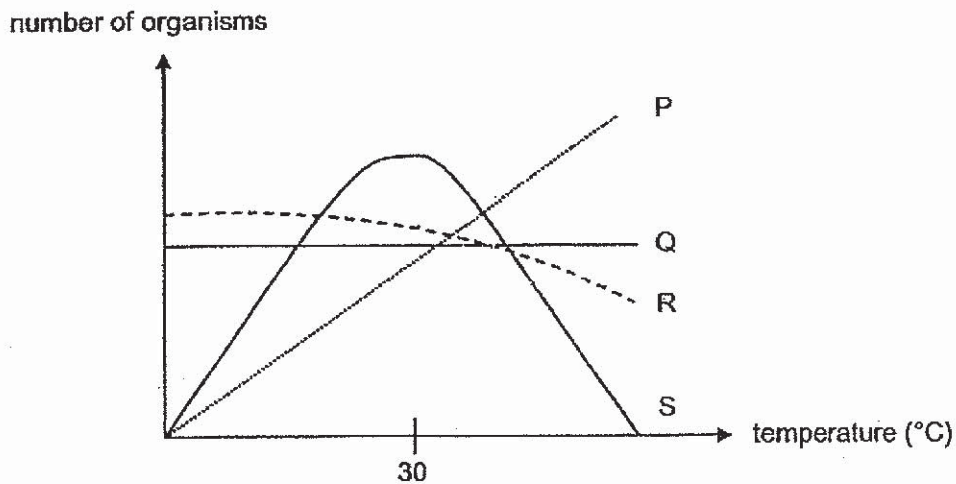

Four pupils made some conclusions.

Amy: Only Organism P grows better in high temperatures than in low temperatures.

Ben: Organism Q grows better in low temperatures than in high temperatures.

Chris: Organism R grows better than organism P at 30 °C.

David: Organism S grows the best in high temperatures as compared to organisms P, Q and R.

Whose conclusion(s) is/are correct?

- (1) David only
- (2) Amy and Chris only
- (3) Ben and Chris only
- (4) Amy, Ben and David only



13. Which of the following statements about deforestation is not correct?
- (1) Deforestation increases the rate of soil erosion.
 - (2) Deforestation decreases the rate of extinction of animals.
 - (3) Deforestation decreases the reproduction of plants in the area.
 - (4) Deforestation increases the amount of carbon dioxide in the atmosphere.
14. Royce conducted an experiment with a flower on a plant.

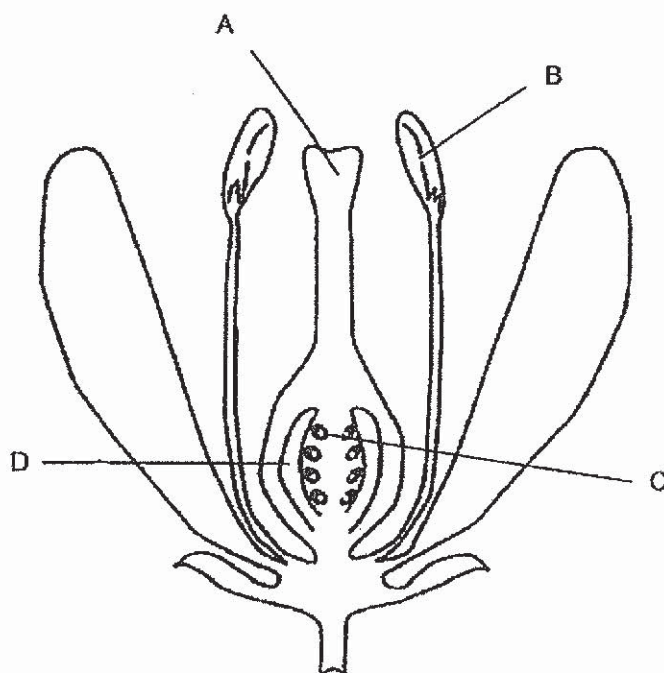

He removed parts of the flower. The flower could **not** develop into a fruit after that. Which part(s) of the flower A, B, C or D did Royce remove?

- (1) A only
- (2) B only
- (3) A and B
- (4) C and D



15. The diagrams below show Jenny blowing air into a float and then sitting on it in water.

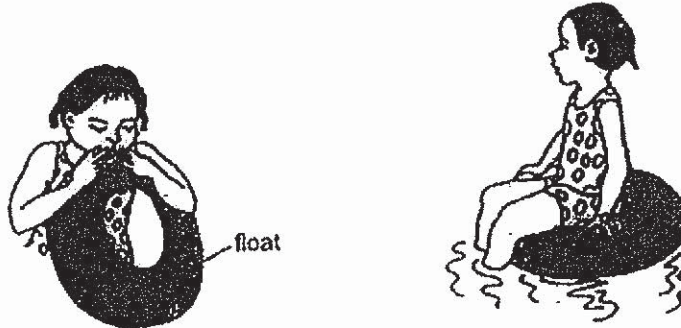

Based on what Jenny has done, which of the following shows correctly the properties of the material used to make the float?

Properties					
	light	waterproof	flexible	colourful	transparent
(1)	✓	✓	✓		
(2)	✓	✓	✓		✓
(3)	✓		✓	✓	
(4)	✓	✓		✓	✓



16. The diagram below shows what happens when 2 bar magnets, PQ and RS, are brought near to each other.

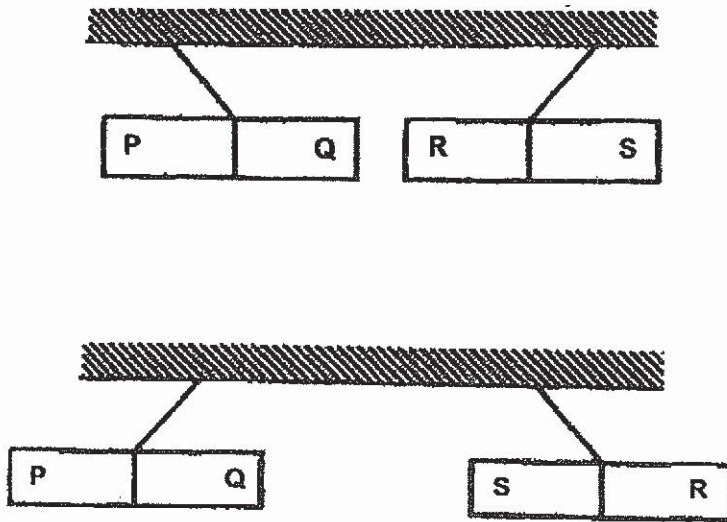

Which of the following statements are correct about the likely poles of the 2 magnets?

- A: P and R are north poles while Q and S are south poles.
- B: Q and S are north poles while P and R are south poles.
- C: P and S are north poles while Q and R are south poles.

- (1) A and B only
- (2) A and C only
- (3) B and C only
- (4) A, B and C



17. The diagram below shows a motorcyclist getting ready to stop at a traffic light that has turned red.

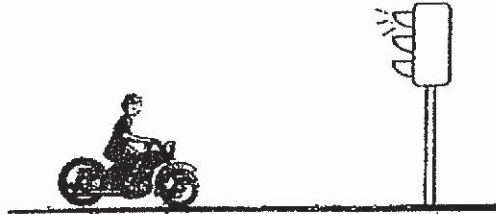

Which one of the following statements explains correctly why the motorcyclist is able to see the red light?

- (1) The traffic light gives out light.
- (2) The traffic light is higher than him.
- (3) His eyes reflect light to the traffic light.
- (4) Red light is more easily seen than green light.



18. Four similar balls of different materials, P, Q, R and S, were placed in liquids X and Y. The balls stayed at the positions as shown below.

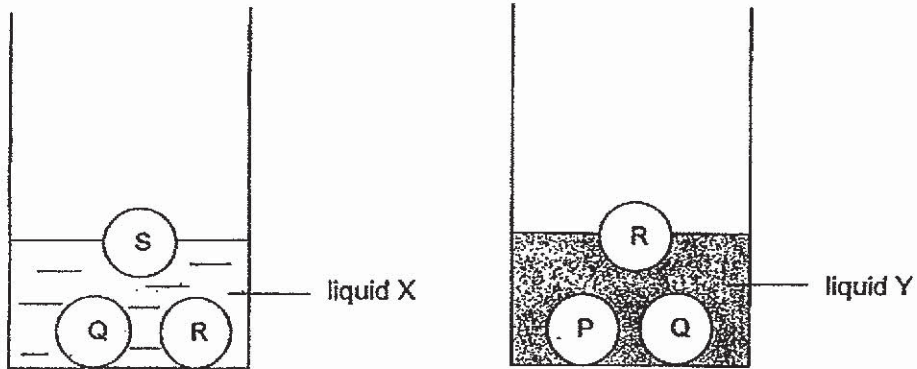

Liquid X and liquid Y do not mix together. When they were poured into a container, liquid X floated on top of liquid Y. If similar balls of materials P, Q, R and S were added to this container, which one of the following diagrams would show their correct positions?

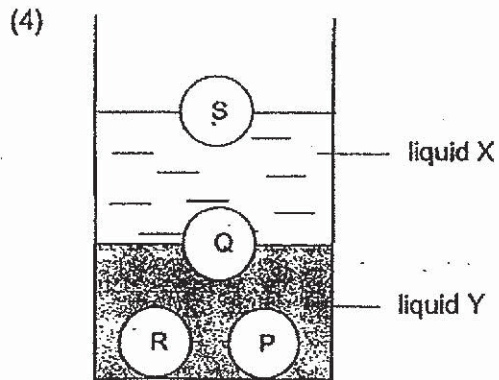
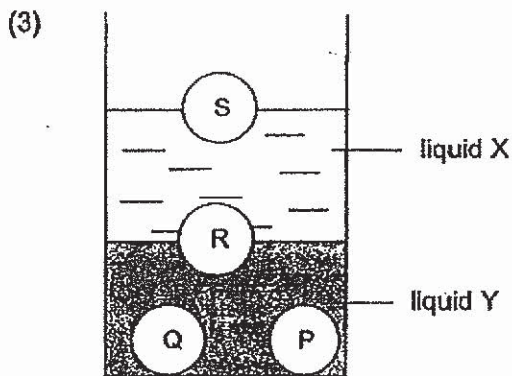
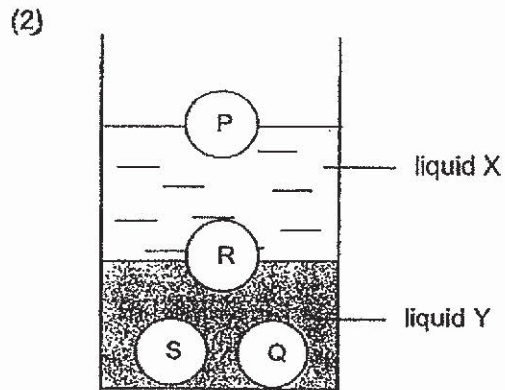
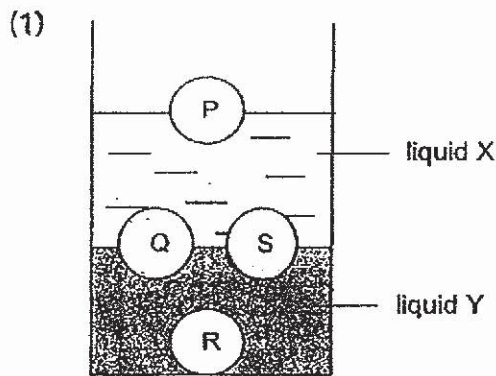

19. The diagram below shows a sealed metal container which had 60 cm^3 of water and 40 cm^3 of air.

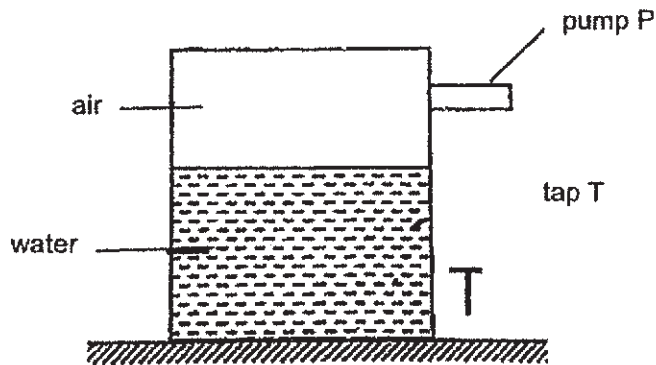

20 cm^3 of water was removed from the container through tap T and 100 cm^3 of air was then pumped in using pump P.

Which of the following shows correctly the change in the mass and volume of water and air in the container?

	air		water	
	mass	volume	mass	volume
(1)	increased	no change	decreased	decreased
(2)	decreased	increased	no change	increased
(3)	increased	increased	decreased	decreased
(4)	no change	no change	decreased	increased



20. Agnes was holding a metal spoon with an ice cube as shown below.

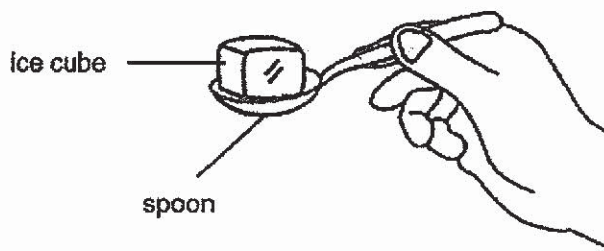

After a while, she felt that the spoon was cold.

Which one of the following statements explains why Agnes felt that the spoon was cold?

- (1) The spoon lost heat to the ice and her fingers.
- (2) The spoon gained heat from the ice and her fingers.
- (3) The spoon gained heat from her fingers but lost heat to the ice.
- (4) The spoon lost heat to her fingers but gained heat from the ice.

21. Three substances, A, B and C, have the following properties.

Substance A freezes at 0°C and boils at 100°C .

Substance B melts at 10°C and boils at 200°C .

Substance C has a high melting point of 1000°C .

Which of the following shows the state of substance A, B and C are likely to be at a temperature of 280°C ?

	A	B	C
(1)	liquid	solid	solid
(2)	solid	liquid	gas
(3)	liquid	gas	gas
(4)	gas	gas	solid



22. Mrs Chong is cooking porridge on a stove. When the porridge boils, substance X is formed as shown in the diagram below.

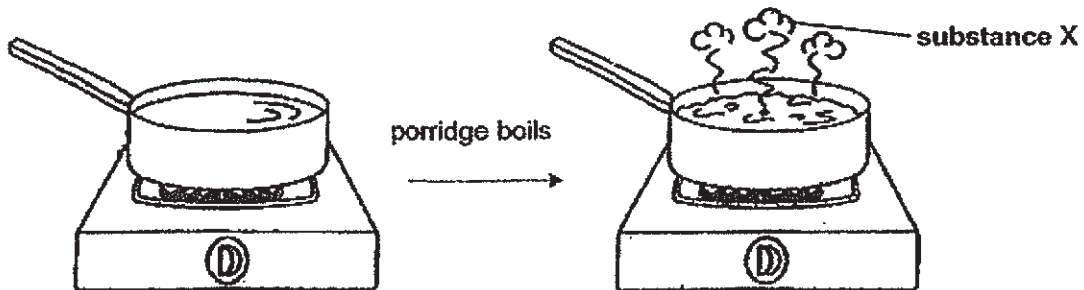

Which of the following shows correctly the state of substance X and the transfer of heat during the process of forming substance X.

	state of substance X	transfer of heat during the process of forming substance X
(1)	liquid	heat gain
(2)	liquid	heat loss
(3)	gas	heat gain
(4)	gas	heat loss



23. Rajah dries his wet hands under a hand-dryer as shown in the diagram below.

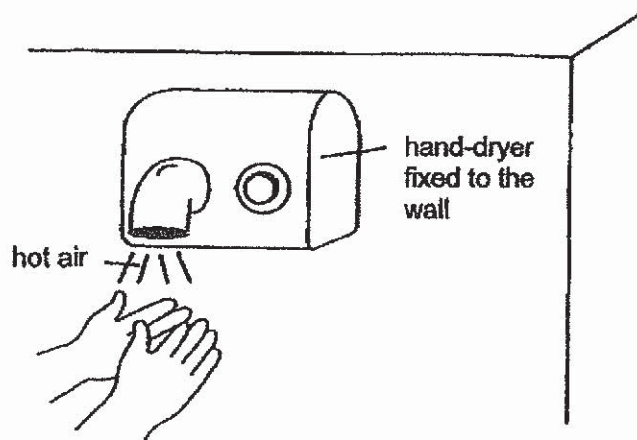

Which one of the following statements are correct?

- A: Wind enables Raju's hands to dry more quickly.
- B: Water first evaporates and then condenses on Raju's hands.
- C: Heat is transferred from the air of the hand-dryer to the water on Raju's hands.

- (1) A and B only
- (2) A and C only
- (3) B and C only
- (4) A, B and C



24. A circuit is set up as shown below. All the bulbs light up.

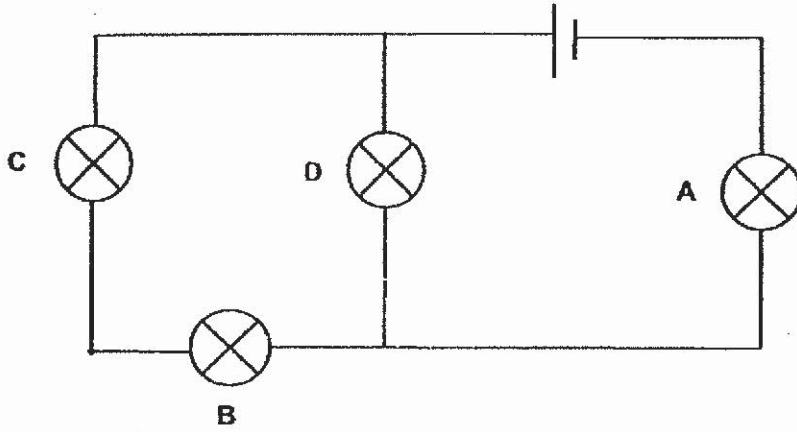

All of a sudden, 2 bulbs fuse but the remaining 2 remain lighted.
Which 2 bulbs have fused?

- (1) A and B
- (2) A and D
- (3) B and C
- (4) C and D



25. When a toy canon is fired, it moves up the slope from P to Q as shown in Diagram 1. The canon then moves back from Q to P on its own as shown in Diagram 2.

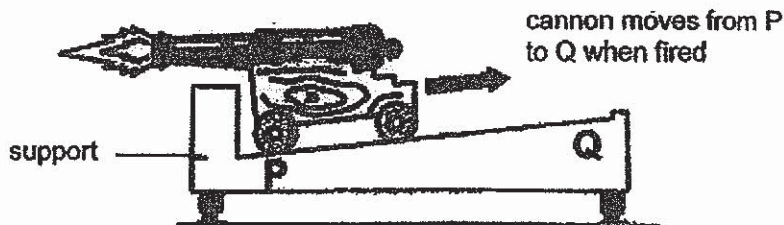

Diagram 1

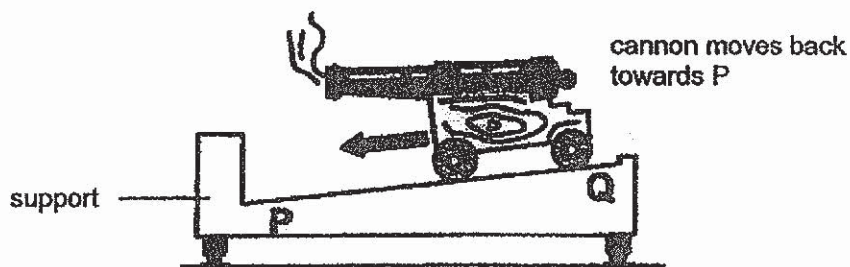

Diagram 2

Which one of the following shows correctly the change in the potential energy and kinetic energy of the canon as it moves from P to Q and then back from Q to P?

	P to Q		Q to P	
	potential energy	kinetic energy	potential energy	kinetic energy
(1)	increases	decreases	decreases	increases
(2)	increases	increases	decreases	decreases
(3)	decreases	increases	increases	decreases
(4)	decreases	decreases	increases	increases



26. Bala glued a balloon to a straw and passed a string through the straw as shown below.

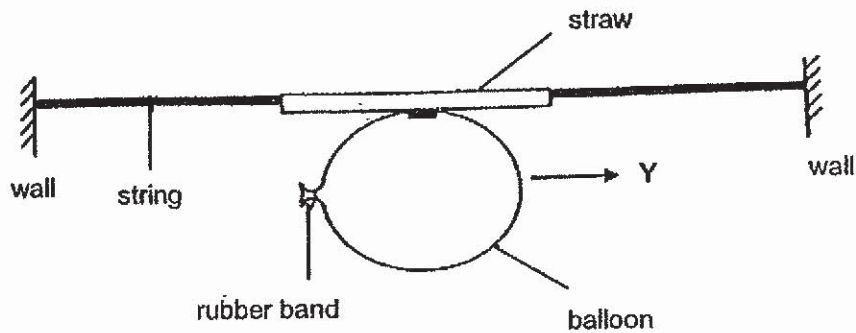

When he removed the rubber band, air rushed out of the balloon, causing the balloon and the straw to move in direction Y.

Which of the following shows correctly the energy conversion in the above experiment?

- (1) elastic potential energy \longrightarrow kinetic energy \longrightarrow kinetic energy + sound energy
- (2) heat energy \longrightarrow kinetic energy \longrightarrow kinetic energy + sound energy
- (3) sound energy \longrightarrow kinetic energy \longrightarrow elastic potential energy + heat energy
- (4) kinetic energy \longrightarrow gravitational potential energy \longrightarrow kinetic energy + sound energy



27. The diagram below shows a bird flying from flower A to flower B.



Which of the following force(s) is/are acting on the bird?

- A: gravitational force
- B: frictional force
- C: magnetic force

- (1) A only
- (2) A and B only
- (3) B and C only
- (4) A, B and C

28. Aunt Lillian placed a bath mat outside a bathroom to prevent herself from slipping when she comes out immediately from the bathroom.

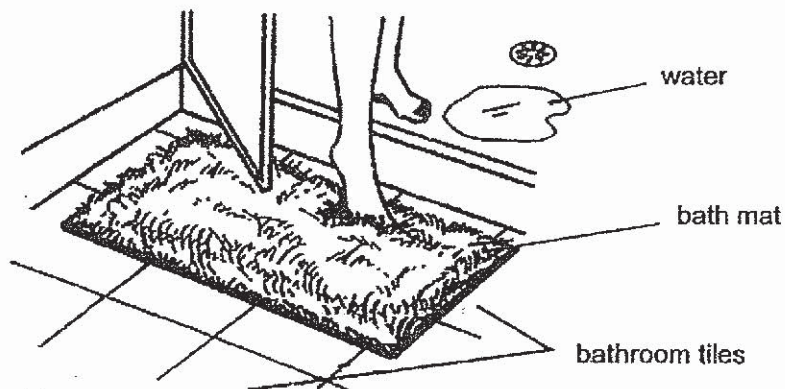

How does the bath mat prevent Aunt Lillian from slipping?

- (1) It supports her whole body weight.
- (2) It enables her to see the tiles more clearly.
- (3) It increases friction between her feet and the tiles.
- (4) It prevents water from being splattered from the bathroom.

End of Booklet A

Page 25





HENRY PARK PRIMARY SCHOOL
FIRST SEMESTRAL ASSESSMENT 2019
PRIMARY 6
SCIENCE
BOOKLET B (44 MARKS)

INSTRUCTIONS TO CANDIDATES

1. Do not turn over this page until you are told to do so.
2. Follow all instructions carefully.
3. Answer all questions.

Name: _____ ()

Class: Primary 6 ()

Date: 22 May 2019

Total Time: 1 h 45 min

Marks for Booklet B: _____

Booklet B (44 marks)

Write your answers to questions 29 to 41 in the spaces given.

29. The diagram shows how blood travels in the human body.

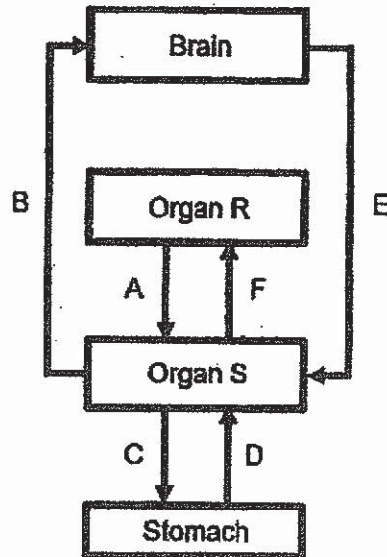

Arrows A, B, C, D, E and F represent the movement of blood. R and S represent two organs that assist in the movement of blood.

a) Name organs R and S. [1]

Organ R: _____

Organ S: _____

b) The blood at B contains a larger amount of substance X than at E. [2]

What is substance X? Explain your answer.



30. Brandon set up an experiment as shown below with a clear glass container and a plant. He left the set-up under the sun for two hours.



In the presence of carbon dioxide, the colourless limewater turns cloudy.

- a) Will the limewater turn cloudy after two hours? Give a reason for your answer. [1]

He repeated the experiment with another set-up shown in the diagram below.

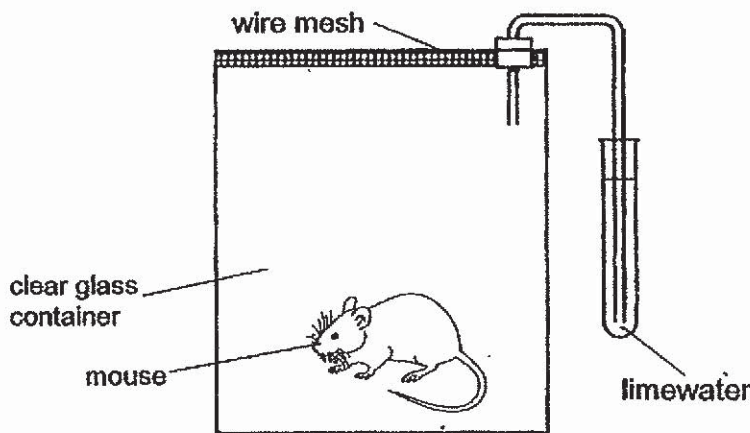

- b) After two hours, Brandon noticed that the limewater remained colourless. Explain why. [1]



31. The picture below shows a seed from a tree in a garden.

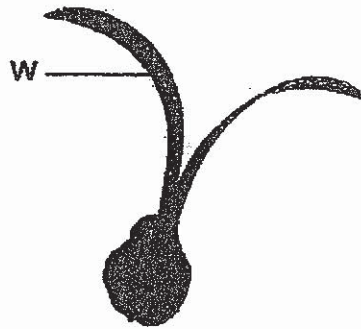

a) Explain how part W helps the seed in its dispersal.

[2]



Question 31 continues on this page

Shanti collected some dispersed seeds around the tree as shown in the diagram below.

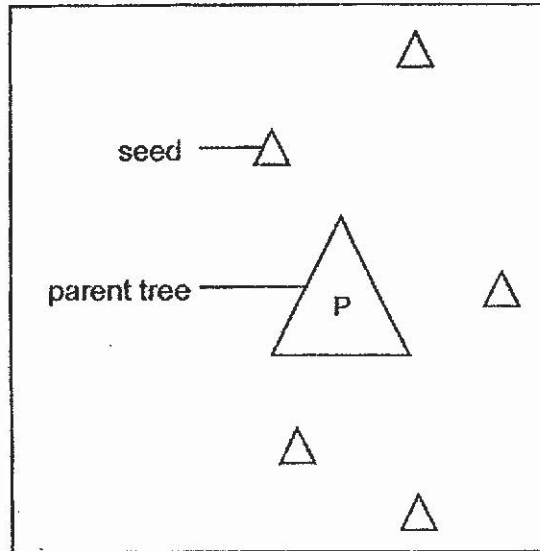

She recorded the distance between the seeds and the tree in the table below.

	seed 1	seed 2	seed 3	seed 4	seed 5
distance (m)	52.3	60.6	43.1	71.2	41.8
area of part W (cm ²)	5.3	7.2	4.3	7.9	4.1

- b) What is the relationship between the area of part W and the distance the seed was dispersed? [1]

- c) Other than the area of part W, state one other variable that will affect the distance the seed was dispersed. [1]



32. The diagram shows how a fruit is formed in a flowering plant.

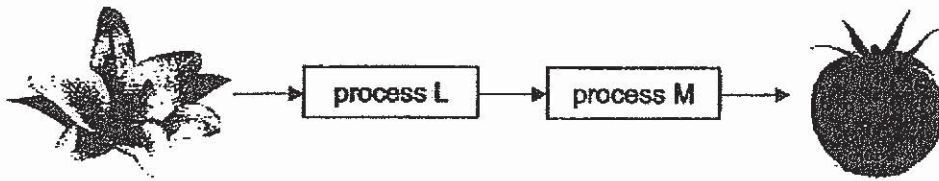

Name and describe process M.

[2]

33. A ring of bark between two branches (A and B) of a plant was removed, as shown below.

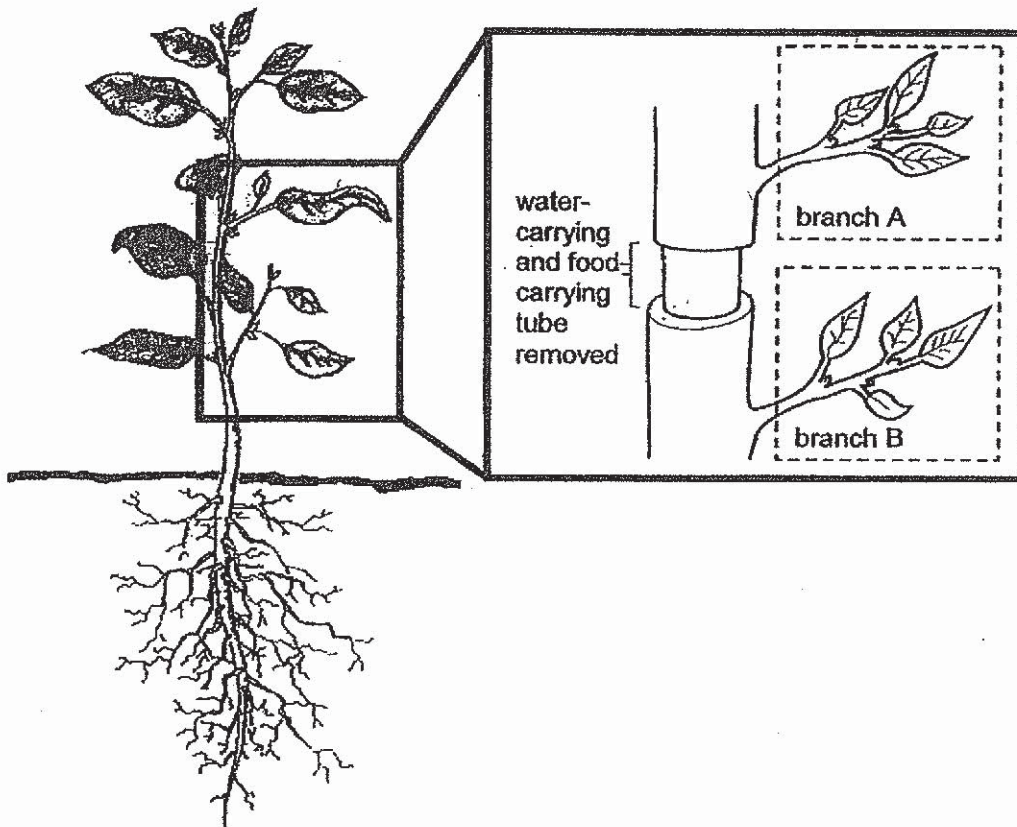

a) What will happen to the leaves on branch A after a few days under the sun? Explain your answer. [2]



Question 33 continues on this page

Robin observed cell G and H from different parts of a plant.

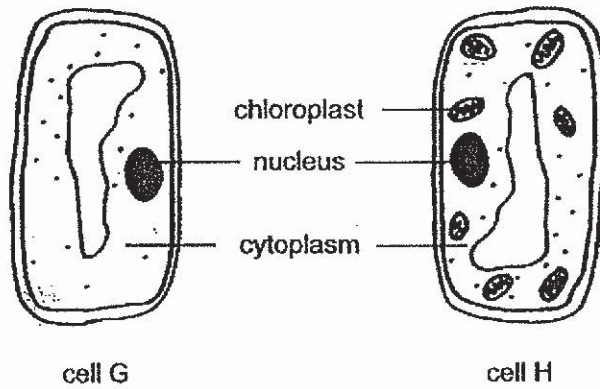

- b) State where cell G and H could be found in the plant and explain why. [2]

Cell G: _____

Cell H: _____



34. Wind energy power plants use wind to generate electricity.

Graphs A and B show the number of wind energy power plants and the temperature of the environment in city S.

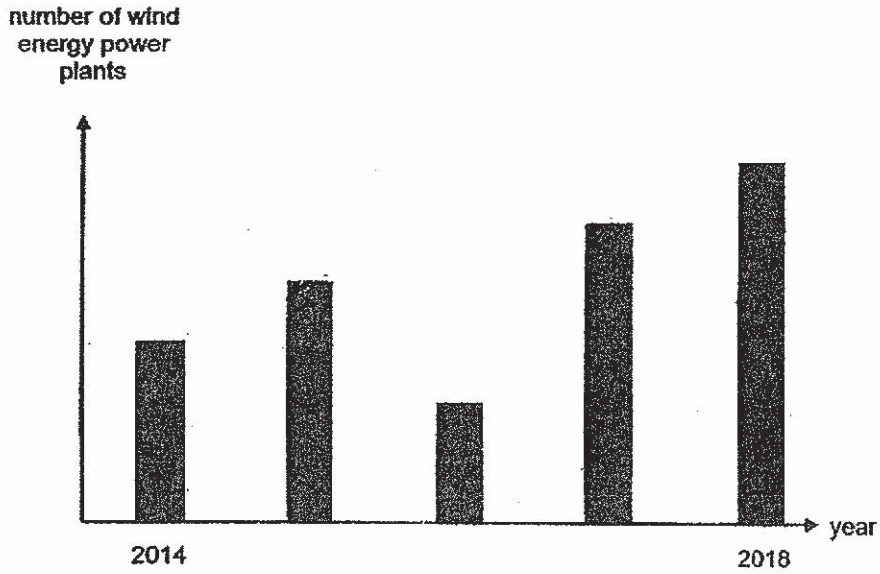

Graph A

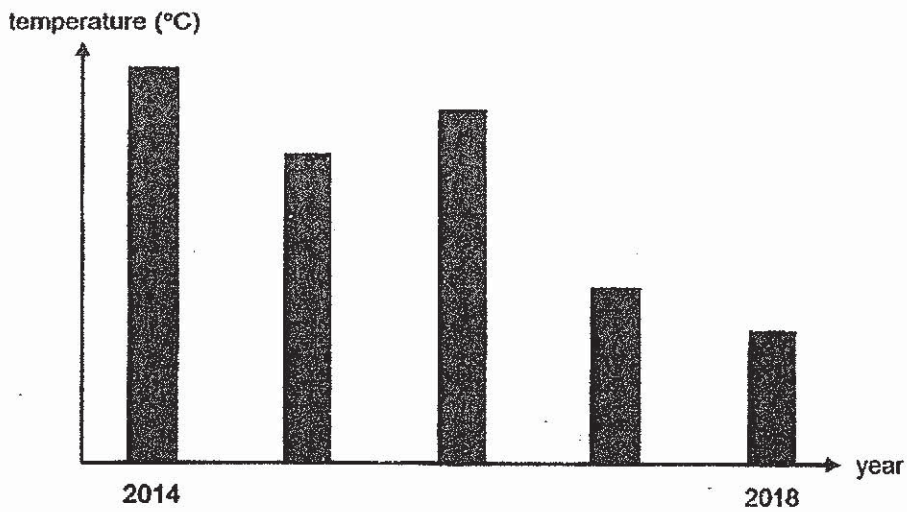

Graph B

a) Explain how the number of wind energy power plants affects the temperature of the environment in city S. [2]



Question 34 continues on this page

b) Suggest how the use of electric vehicles and bicycles benefits the environment. [2]

Benefit 1: _____

Benefit 2: _____



35. Read the short article on the life cycle of a salmon shown in the diagrams below.

The salmon starts its life as an egg. The just-hatched fish is called an *alevin* and still has the yolk sac attached to its body. When its yolk sac is absorbed and it begins to swim freely, it is called a *fry*. As the salmon matures into an adult, it starts feeding on microscopic animals and aquatic insects.

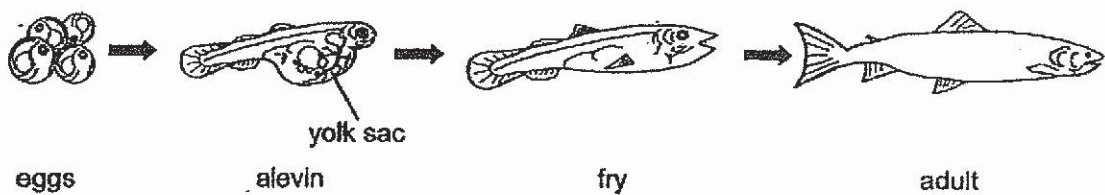

The diagram below shows the life cycle of a bean plant.

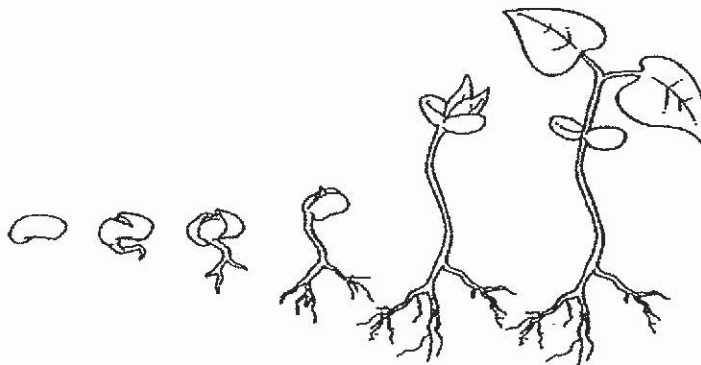

a) Explain how the way an alevin obtains its food is similar to the way a seed obtains its food during germination. [1]

b) Name the conditions necessary for germination [1]



Question 35 continues on this page

- c) Ben and Dan are identical twins. They have attached earlobes like their father.

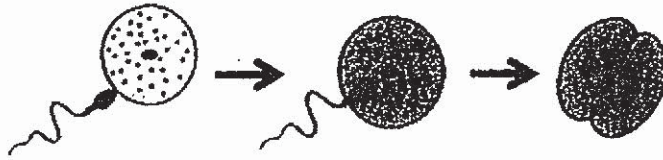

Using the diagram given, explain how Ben and Dan inherited the trait from their father. [2]
father.



36. Matthew conducted an experiment shown below.

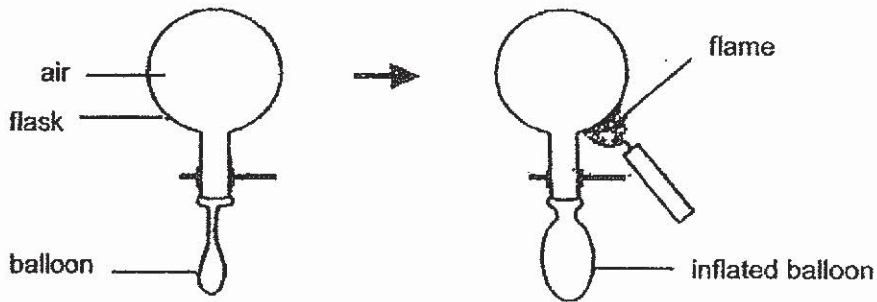

a) What does Matthew's experiment show about heat and the property of air? [1]

The diagram below shows carpark lots which are often covered with concrete blocks with spaces between them.

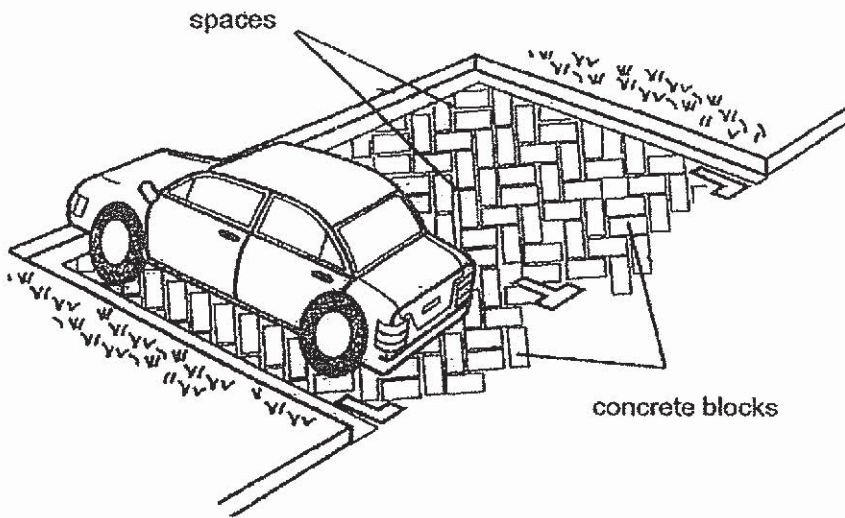

b) Explain why there are spaces between the concrete blocks. [2]



37. Sally wanted to find out which is the best way to keep water warm using the set-up shown below. She poured equal amount of hot water into three similar paper cups.

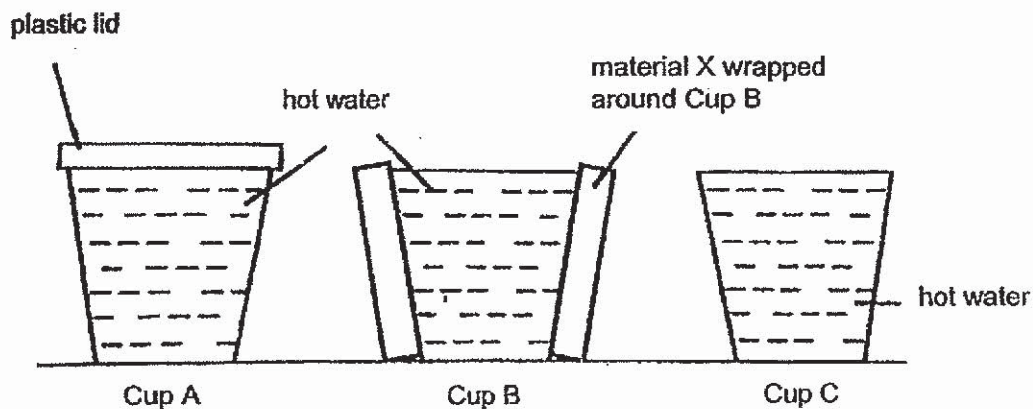

She measured the temperature of water in each cup. Her results are shown in the graph below.

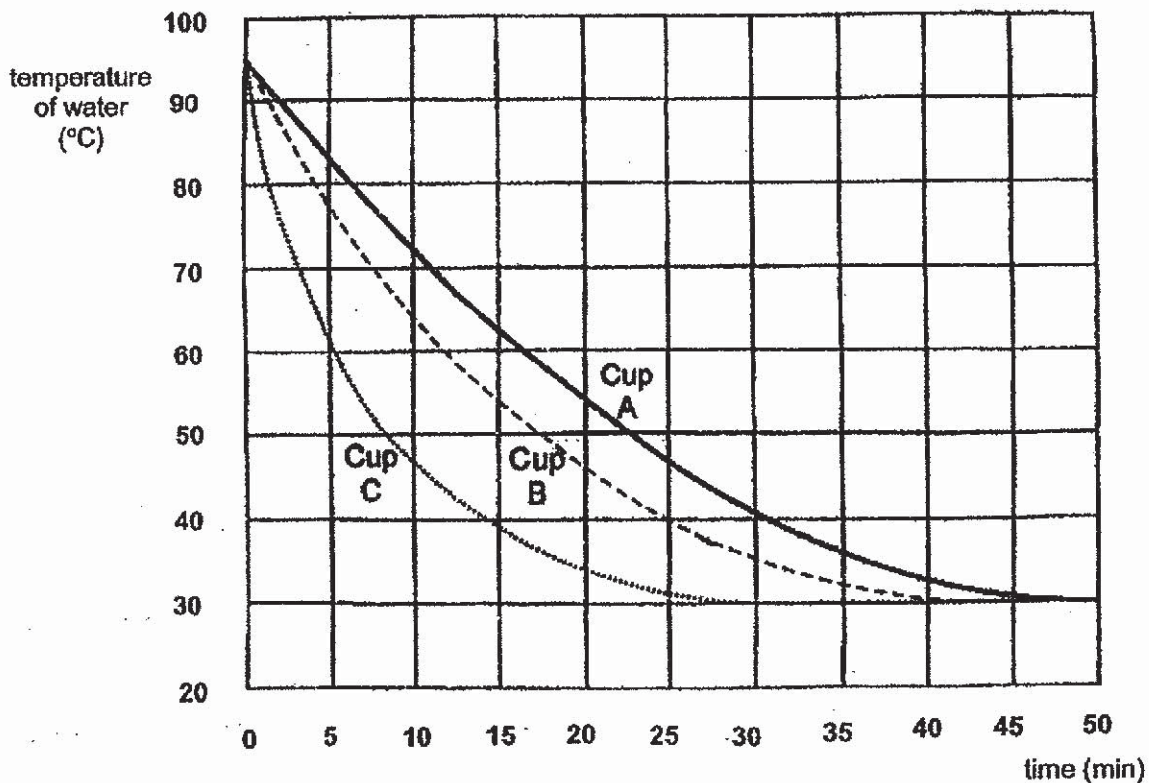

- (a) Sally concluded that plastic is a poorer conductor of heat than material X.

Has she made the correct conclusion? Explain your answer.

[1]

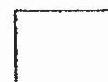

Question 37 continues on this page

b) Explain the purpose of cup C in the experiment.

[1]

The container shown below is made of plastic. It can be used for keeping cold drinks and ice when going on a picnic.

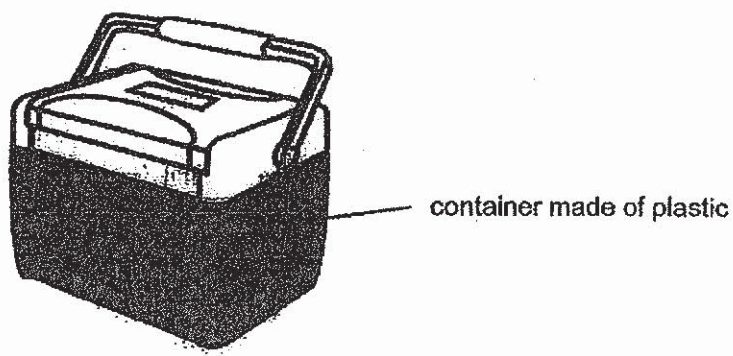

c) Explain how the cold drinks can be kept cold in the plastic container.

[1]



38. The lighting circuit of Daniel's house is shown in the diagram below.

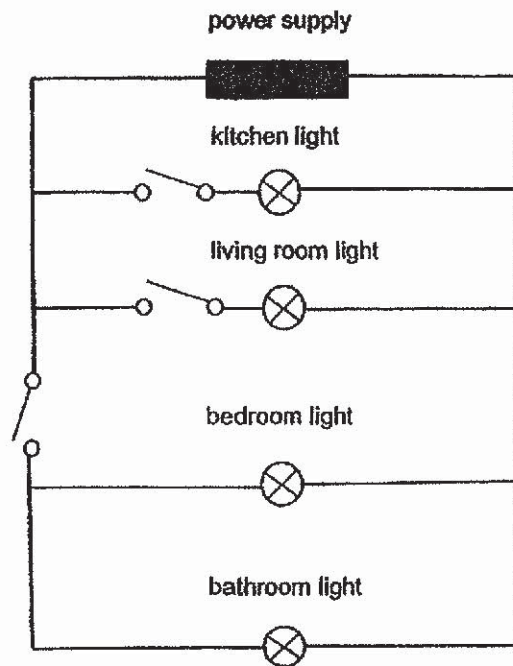

a) His friend, Farah, suggested that he improves the lighting circuit for two areas of his house as it does not help to conserve electricity.

Which **two** areas of his house is Farah referring to?

[1]

(i) _____ (ii) _____

b) In the box below, use circuit diagram to draw the lighting circuit based on Farah's suggestion.

[1]



39. Alice made a wind chime using three metal tubes and a clapper as shown below.

When the wind blows, the clapper hits the metal tubes to produce a sound.

a) State the energy conversion in the wind chime when the wind blows to produce sounds. Write your answer in the boxes below.

[1]

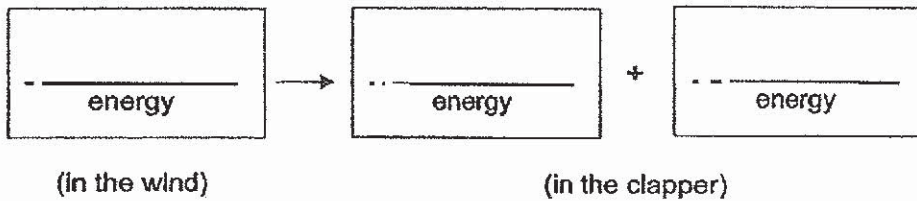
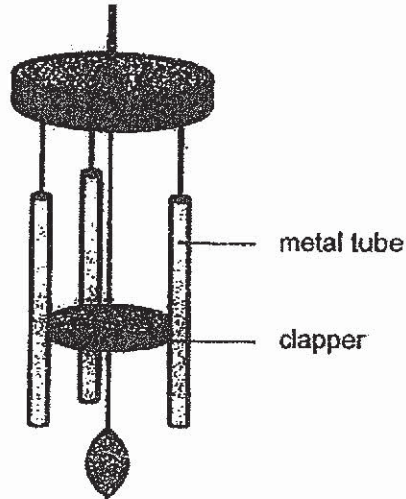

b) How does the strength of wind affect the frequency of the sounds produced?

[1]

c) Explain your answer in (b) using energy conversion.

[2]



40. Alvin uses the set-up shown below to take photographs of birds automatically when they land on S.

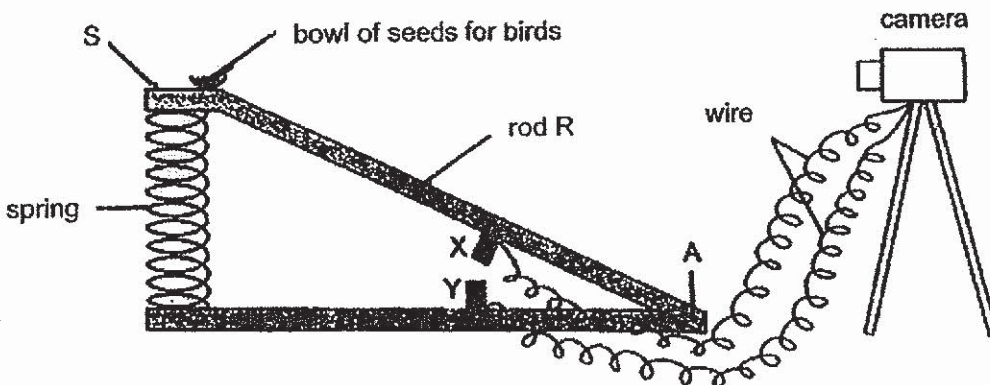

The rod R is pivoted at A.

X and Y are connected to a special camera by wires such that when X touches Y, the camera will take a photograph of the bird at S.

- a) State the property of X and Y which enables the camera to work. [1]

- b) Name the force exerted by the spring when a bird stands on S. [1]

- c) Give a reason for your answer in (b). [1]

The diagram below shows two birds, P and Q, which Alvin observed to have landed on S on separate occasions.



bird P of mass 300g



bird Q of mass 750g

However, the camera could only take a photograph of bird Q and not bird P.

- d) Explain why bird P could not be photographed [2]



41. Janet carried out an experiment with two wooden blocks, A and B. They are of similar heights but have different base area in contact with the table top. She tried to find out how much she had to tilt each block before it toppled.

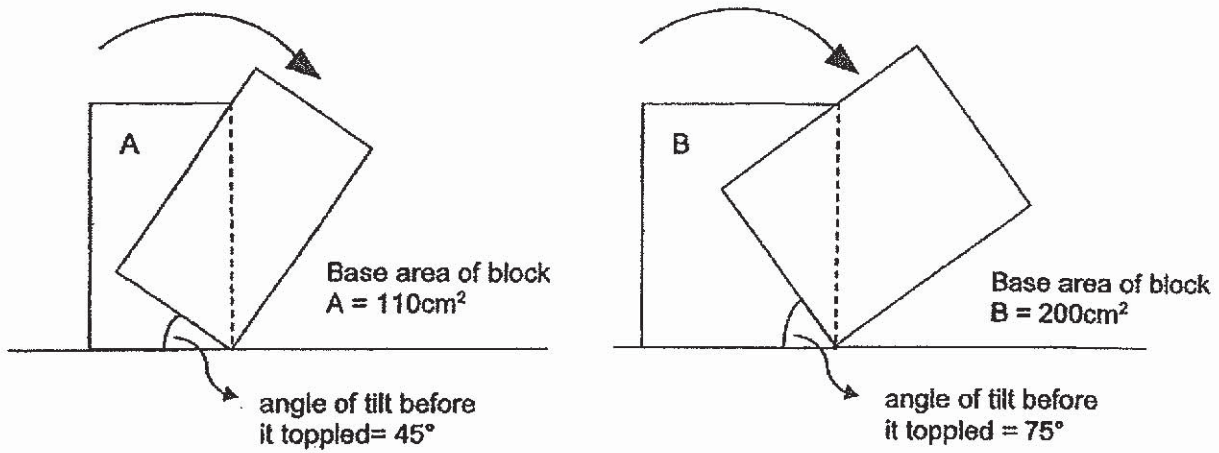

- a) Based on the experiment, which variable indicates how easily the block topples? [1]

The diagram below shows a high chair.

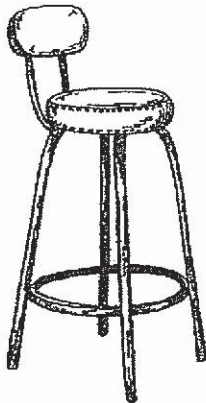

- b) Based on the results of Janet's experiment, explain why the legs of the high chair are widely spread out. [1]



Question 41 continues on this page

Janet conducted another experiment using blocks, X, Y and Z as shown below.

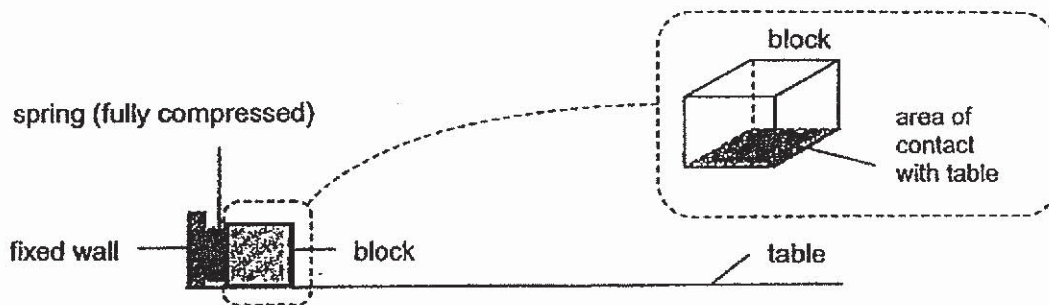

She measured the distance the blocks moved after releasing the spring. Her results are shown in the table below.

block	mass (g)	area of block in contact with the table (cm ²)	distance moved (cm)
X	50	100	9
Y	80	220	12
Z	80	100	12

- c) Name the force that is between the block and the table. [1]

- d) Based on the information in the table, state which variable affects the force mentioned in (c). [1]

End of Booklet B

Setters: Dr Evelyn Tan and Miss Kuek Tsing Xiu



2019 P6 SA1 Science
Correction Sheet

Name: _____ () Class: _____

Booklet A

1.	2	11.	2	21.	4
2.	3	12.	2	22.	2
3.	2	13.	2	23.	2
4.	4	14.	4	24.	3
5.	2	15.	1	25.	1
6.	1	16.	1	26.	1
7.	1	17.	1	27.	2
8.	2	18.	3	28.	3
9.	2	19.	3		
10.	2	20.	3		

Booklet B

Question	Suggested answer
29a	Organ R: lung(s) Organ S: heart
29b	At B, the blood that is rich in oxygen has just left the heart. At E, some of the oxygen in the blood has already been taken up by the brain.
30a	No. In the presence of light, the plant in the container will be able to take in carbon dioxide to photosynthesise.
30b	The carbon dioxide given out by the mouse could escape from the glass container through the wire mesh.
31a	Part W is a wing-like part that helps the seed stay longer in the air and be dispersed further away from the parent tree.
31b	The greater the area of Part W, the further the distance of the seed from the tree.
31c	Mass/weight of the seed / intensity/speed of the wind / size/area of seed / thickness/number of part W / presence/amount/duration of wind / height at which the seed was dispersed
32	Fertilisation. The male reproductive cell in the pollen tube fuses with the egg cell in the ovule.
33a	The leaves on branch A will wither/die because the leaves cannot get water to photosynthesise.
33b	Cell G: It is found in the roots / stem / branch as it does not contain chloroplasts needed for photosynthesis. Cell H: It is found in the _____ as it contains chloroplasts needed for photosynthesis.
34a	The more _____ are, the lower the emission of carbon dioxide. _____ neat will be trapped by the carbon dioxide, the _____ S will be lower.
34b	_____ gas emission / use of recycled materials to produce _____ ele _____ increased use of renewable energy resources / reduced use of fo _____

2019 P6 SA1 Science
Correction Sheet

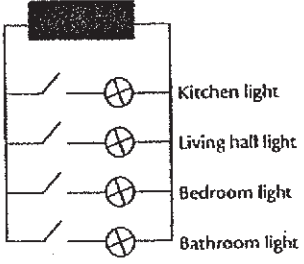
35a	The seedling / germinating seed gets stored food from its seed leaves just like the alevin gets its food from the yolk sac attached to its body.
35b	Air/oxygen, water/moisture, warmth
35c	The nucleus of the sperm cell contains the father's genetic information which is passed down to the twins when the sperm cell and egg cell fuse.
36a	Air expands when heated.
36b	On a hot/sunny day, the concrete blocks gain heat and expand. The spaces prevent the blocks from pushing/pressing against one another and breaking.
37a	No. The plastic and material X are covering different parts of the cup.
37b	It is used to compare and confirm that the differences in temperature of the water are due to the plastic and material X.
37c	Plastic is a poor conductor of heat hence the cold drinks and ice gain heat slowly from the surrounding.
38a	(i) bedroom (ii) bathroom
38b	
39a	kinetic energy, kinetic energy + sound energy
39b	The stronger the wind, the more frequent the sounds.
39c	There is more kinetic energy in the wind to be converted to more kinetic energy of the clapper, causing it to hit the metal tubes more times, thus creating more sounds.
40a	Conductors of electricity
40b	Elastic spring force
40c	The spring is compressed.
40d	Bird P has a smaller mass so it cannot compress the spring for X and Y to touch each other to form a closed circuit for electricity to flow through.
41a	The angle of tilt before the block topples.
41b	To increase the base area so that the chair will be more stable / chair will not topple easily.
41c	Frictional force / friction
41d	Mass of the block

