

**RIVER VALLEY PRIMARY SCHOOL  
2019 SEMESTRAL ASSESSMENT 1 (SA1)  
PRIMARY 6**

**STANDARD SCIENCE**

**(BOOKLET A)**

Name : \_\_\_\_\_ ( )

Date : 22/05/2019 (Wed)

Class : P6 \_\_\_\_\_

Time: 1 hour 45 min

**INSTRUCTIONS TO CANDIDATES**

1. Write your name, index number and class in the space above.
2. Do not turn over this page until you are told to do so.
3. Follow all instructions carefully.
4. Answer all questions.
5. For Section A, shade your answers for questions 1 to 28 on the Optical Answer Sheet (OAS).
6. For Section B, write your answers for questions 29 to 40 in the space provided.
7. The total marks for Booklet A is 56 marks.

**Section A (56 marks)**

For each question 1 to 28, four options are given. One of them is the correct answer. Make your choice (1, 2, 3 or 4). Shade the oval (1, 2, 3 or 4) on the Optical Answer Sheet.

1. The diagram below shows two organisms X and Y.

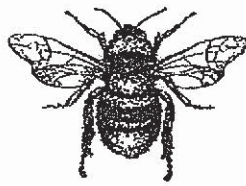

Organism X

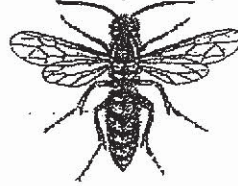

Organism Y

Organism X stings and feeds on smaller organisms such as ants and spiders.  
Organism Y looks similar to Organism X. It feeds on nectar but does not sting.

Which of the following is a benefit for Organism Y to resemble Organism X?

- (1) Predators of Organism X will prey on Organism Y too.
- (2) Predators of Organism Y will avoid preying on Organism Y.
- (3) Organism Y will be able to mate with Organism X to reproduce.
- (4) Organism Y will be able to feed on ants and spiders like Organism X.

( )

2. The table below shows some information about three different organisms, X, Y and Z.

Organism	Information
X	<ul style="list-style-type: none"> <li>• Weak stem</li> <li>• Pollinated by wind</li> </ul>
Y	<ul style="list-style-type: none"> <li>• Lives in a desert</li> <li>• Walks on sandy grounds</li> </ul>
Z	<ul style="list-style-type: none"> <li>• Spends most of the time in the water</li> <li>• Feeds on animals which are active at night</li> </ul>

Which one of the following descriptions shows the correct adaptations of the three organisms respectively?

	Organism X	Organism Y	Organism Z
(1)	<ul style="list-style-type: none"> <li>• Has climbing stem</li> <li>• Bright coloured flowers</li> </ul>	<ul style="list-style-type: none"> <li>• Large ears</li> <li>• Sharp vision</li> </ul>	<ul style="list-style-type: none"> <li>• Streamlined body</li> <li>• Good night vision</li> </ul>
(2)	<ul style="list-style-type: none"> <li>• Has climbing stem</li> <li>• Stigma hanging outside petals</li> </ul>	<ul style="list-style-type: none"> <li>• Sweats very little</li> <li>• Padded feet</li> </ul>	<ul style="list-style-type: none"> <li>• Streamlined body</li> <li>• Webbed feet</li> </ul>
(3)	<ul style="list-style-type: none"> <li>• Has thorns</li> <li>• Feather-like stigma</li> </ul>	<ul style="list-style-type: none"> <li>• Urinates very little</li> <li>• Webbed feet</li> </ul>	<ul style="list-style-type: none"> <li>• Short wingspan</li> <li>• Good sense of hearing</li> </ul>
(4)	<ul style="list-style-type: none"> <li>• Has climbing stem</li> <li>• Anthers hanging outside petals</li> </ul>	<ul style="list-style-type: none"> <li>• Active at night</li> <li>• Sharp claws</li> </ul>	<ul style="list-style-type: none"> <li>• Waxy feathers</li> <li>• Long beaks</li> </ul>

( )

3. Tom and his family were trapped in an enclosed lift for half an hour as shown in the diagram below. There was no fresh air entering the lift.

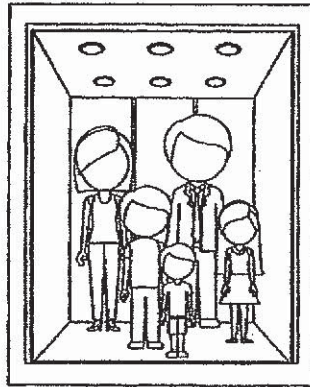

Which one of the following correctly shows the changes in the composition of gases in Tom's blood after half an hour of being trapped in the lift?

Changes in the composition of gases in Tom's blood			
	carbon dioxide	oxygen	nitrogen
( 1 )	increases	decreases	decreases
( 2 )	decreases	increases	remains the same
( 3 )	decreases	increases	increases
( 4 )	increases	decreases	remains the same

( )

4. The diagram below shows a part of the human digestive system.

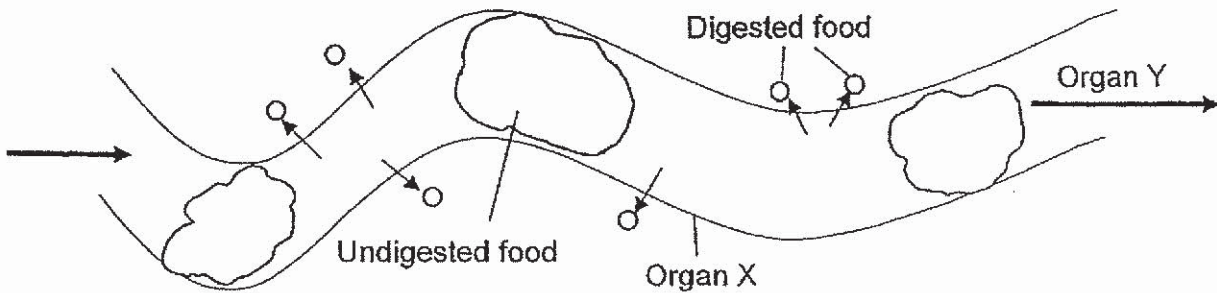

Which of the following shows the correct Organs X and Y?

	X	Y
(1)	Small intestine	Large intestine
(2)	Stomach	Small intestine
(3)	Gullet	Stomach
(4)	Large intestine	Anus

( )

5. The diagram shows the life cycle of a flowering plant.

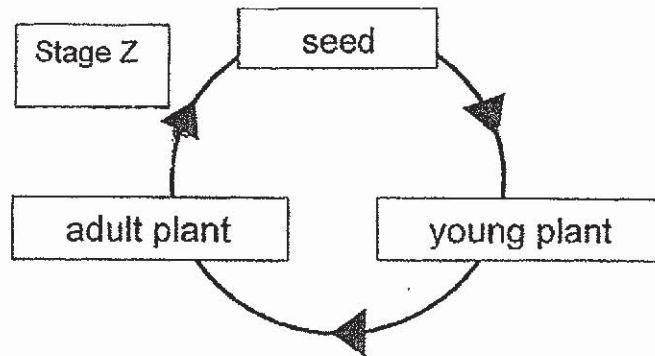

Which one of the following statements describes Stage Z correctly?

A: The flower gives off a scent to attract insects.

B: Pollen grains from the anther lands on the stigma.

C: The plant uses the food stored in the seed leaves.

D: Special characteristics help the seeds scatter away from parent plant.

( 1 ) A and B only

( 2 ) A, B and D only

( 3 ) B, C and D only

( 4 ) All of the above

( )

6. Which of the following statements are true about the sexual reproduction in humans?

A: The male reproductive cell is the sperm.

B: The fertilized egg develops in the stomach of the female's body.

C: Fertilization usually takes place in the ovary of the female's body.

D: Fertilization takes place when the male and female reproductive cells fuse.

( 1 ) A and D only

( 2 ) B and C only

( 3 ) C and D only

( 4 ) A, B and C only

( )

7. Two cells X and Y are shown below.

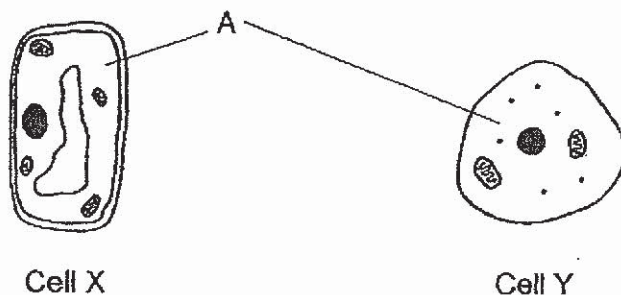

Which of the following gives the correct classification of the cells and the function of Part A?

	Animal Cell	Plant Cell	Function of Part A
(1)	X, Y	-	controls movement of substances in and out of the cell
(2)	Y	X	controls movement of substances in and out of the cell
(3)	Y	X	allows movement of substances within the cell
(4)	X	Y	allows movement of substances within the cell

( )



8. The graph below shows the number of days of each stage of the life cycles of plants X and Y.

Number of days

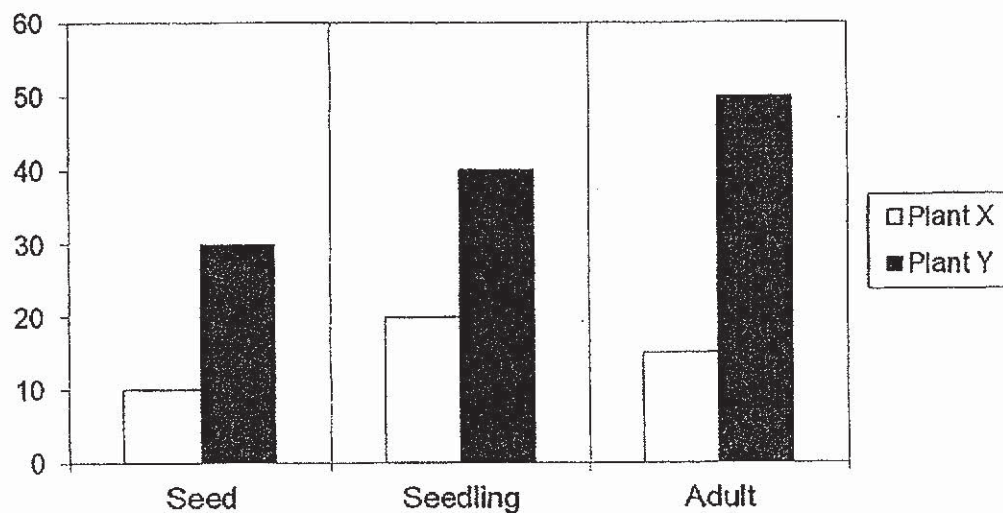

In which stage would Plants X and Y be on the 40th day of their life cycle?

	Plant X	Plant Y
(1)	Adult	Seedling
(2)	Seed	Adult
(3)	Adult	Adult
(4)	Seedling	Seedling

( )

9. Study the flowchart below.

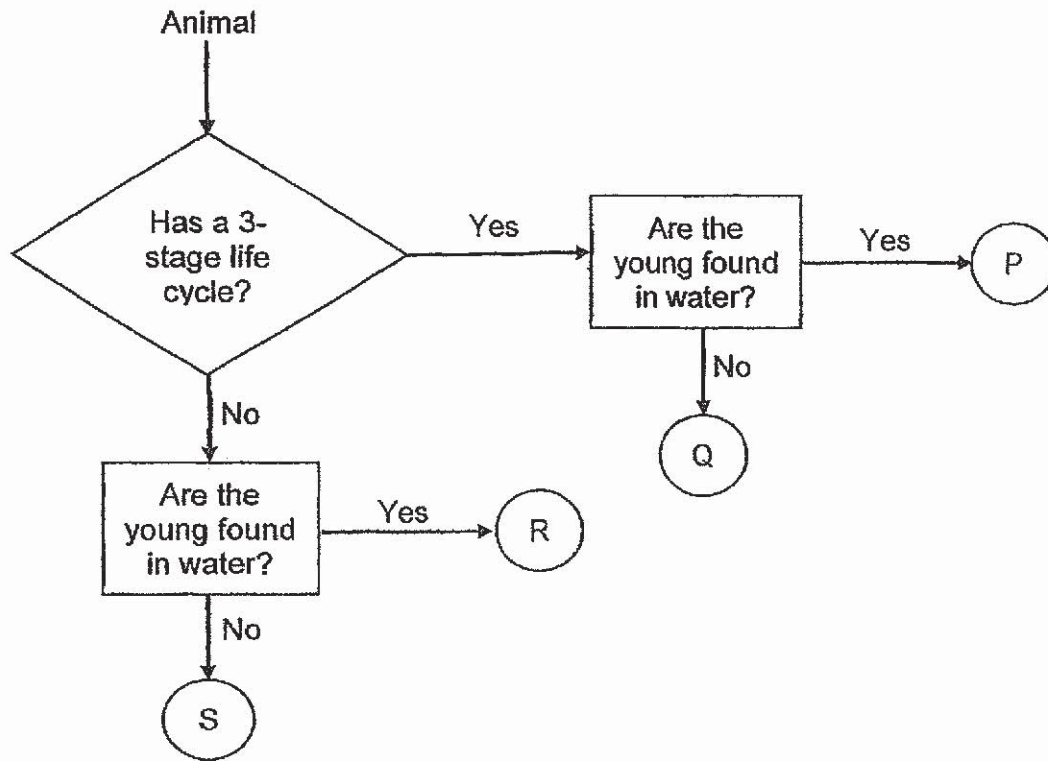

Which of the following shows the correct grouping for P, Q, R and S?

	P	Q	R	S
(1)	Frog	Chicken	Mosquito	Butterfly
(2)	Chicken	Mosquito	Butterfly	Frog
(3)	Mosquito	Grasshopper	Frog	Beetle
(4)	Cockroach	Frog	Beetle	Mosquito

( )

10. The table below compares the life cycles of animal A and B.

Characteristics	A	B
4 stages in the life cycle	No	Yes
Lays eggs on land	No	Yes
The young resembles the adult	Yes	No
It is a pest during the larva stage	No	Yes

Based on the graph above, what can animal A and B be?

	A	B
( 1 )	grasshopper	butterfly
( 2 )	beetle	cockroach
( 3 )	frog	beetle
( 4 )	grasshopper	mosquito

( )

11. Min tries to throw his bottle so that it can land on the table standing upright at S. He swings the bottle backward to point P and then swings to point Q before releasing it. The bottle reaches its maximum height at point R and lands at point S.

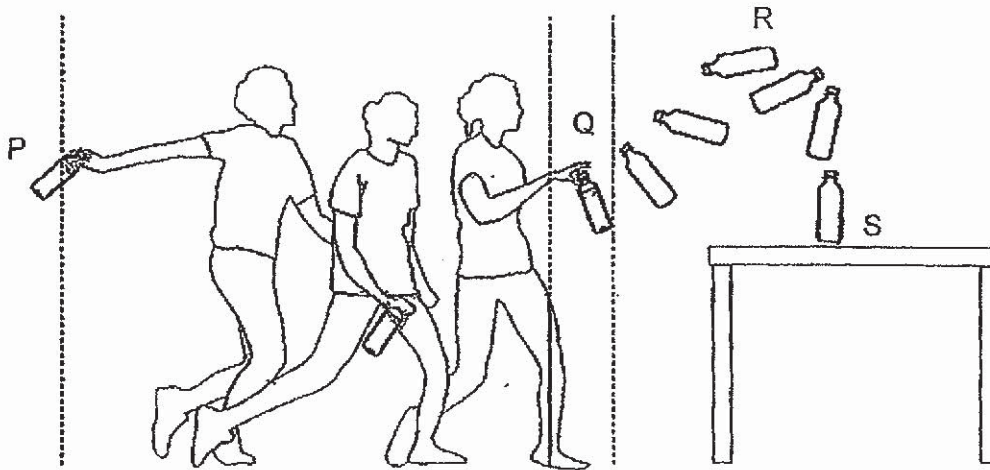

Which one of the following statements is true?

- ( 1 ) There is no gravitational force acting at S.
- ( 2 ) The gravitational force at R is more than at S.
- ( 3 ) The amount of potential energy at R is the highest.
- ( 4 ) The amount of kinetic energy is increasing from Q to R.

( )

12. Haley left a battery-operated car at the bottom of a slope as shown below.

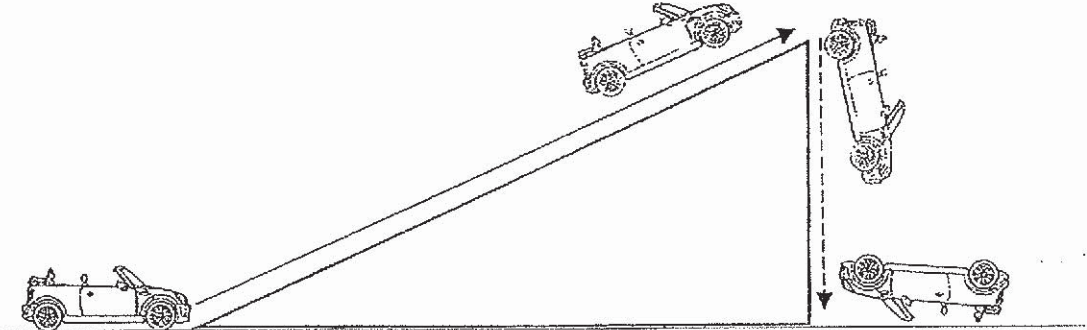

Once she pressed the "GO" button on her remote control, the car moved up the slope. She stopped the car just before it reached the edge at the top but it fell down to the floor.

Which one of the following correctly shows the correct energy conversion which took place after she pressed the "GO" button on her remote control?

- ( 1 ) kinetic energy  $\rightarrow$  potential energy  $\rightarrow$  sound + heat energy
- ( 2 ) electrical energy  $\rightarrow$  potential energy  $\rightarrow$  sound + heat energy
- ( 3 ) potential energy  $\rightarrow$  electrical energy  $\rightarrow$  kinetic energy  $\rightarrow$  sound + heat energy
- ( 4 ) potential energy  $\rightarrow$  electrical energy  $\rightarrow$  potential energy  $\rightarrow$  sound + heat energy

( . . )



14. Deming observed the organisms found in a garden and recorded the number of each organism in a graph as shown below.

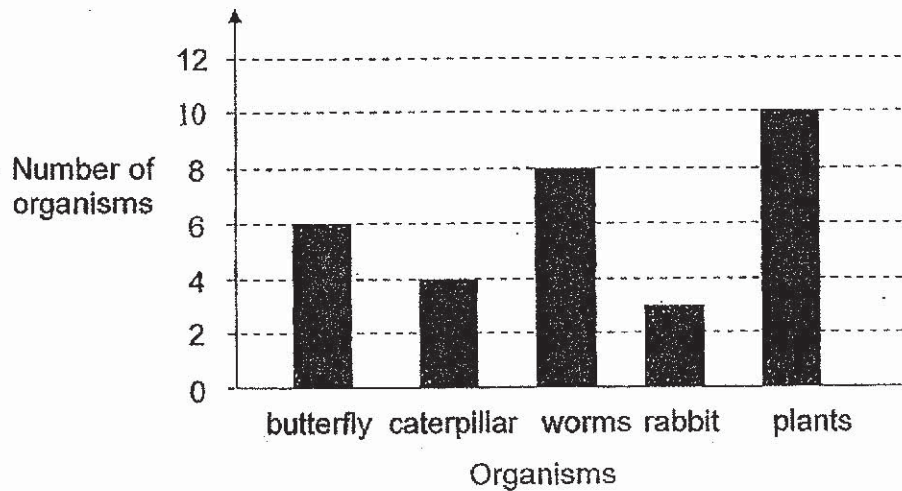

Based on the information given above, which of the following statements are definitely correct?

- A: The garden is the habitat of the organisms.
- B: There are ten populations of plants in the garden.
- C: There is a total of 31 communities in the garden.
- D: There are four populations living in the garden.

- (1) A and C only
- (2) A and D only
- (3) B and C only
- (4) B and D only

( )

15. The diagram below shows what Zehua eats for dinner.

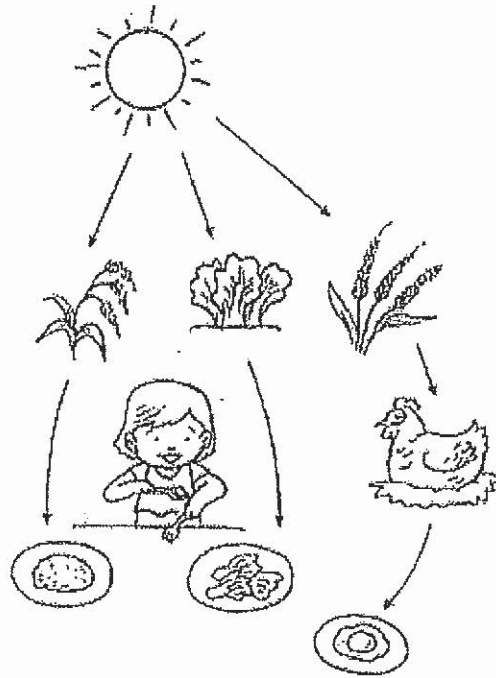

Her friends, Ali, Ben, Cara and Devi made the following statements:

Ali: Animals are the main source of energy.

Ben: The energy in the food that Zehua eats comes from the Sun indirectly.

Cara: Zehua eats in order to get energy to carry out life processes.

Devi: Energy is transferred from the Sun to plants and then to animals.

Who made the correct statements?

- (1) Ali and Ben only
- (2) Ben and Cara only
- (3) Ali, Cara and Devi only
- (4) Ben, Cara and Devi only

( )



16. The diagram below shows the legs of three birds J, K and L which feed on fish.

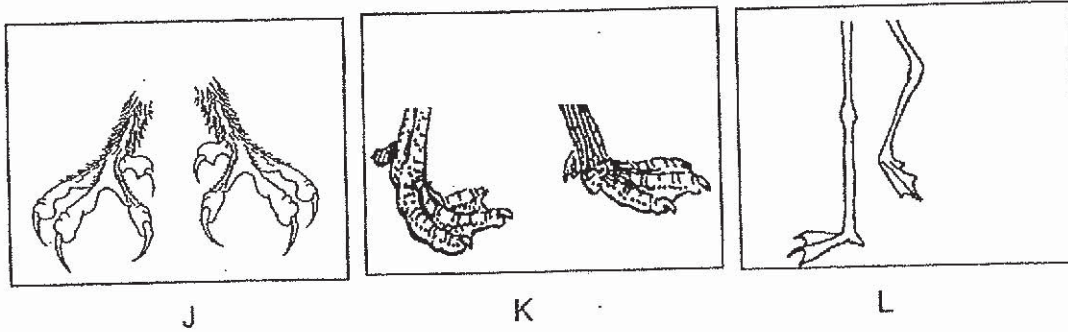

They are usually seen in different parts A, B and C of the habitat below.

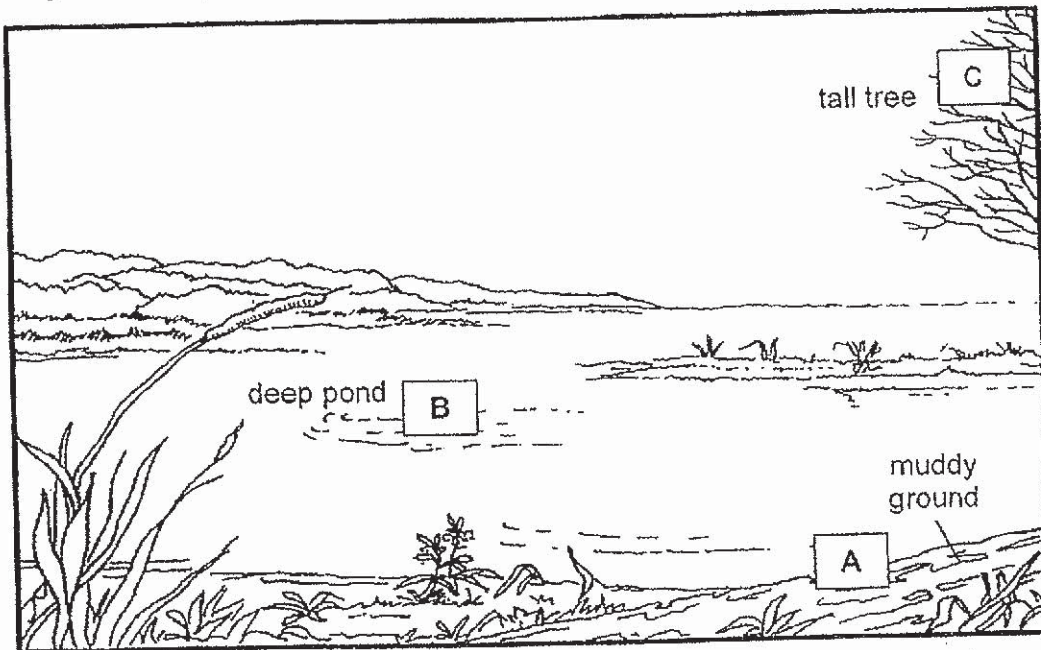

Which of the birds J, K and L are most likely to be found at A, B and C?

	A	B	C
(1)	J	K	L
(2)	K	L	J
(3)	L	J	K
(4)	J	L	K

( )

17. Timothy used a set up to show the water cycle. He poured some hot water at  $90^{\circ}\text{C}$  into a glass A. He then turned glass B upside down and placed it on top of A. Next, he placed an ice cube on glass B.

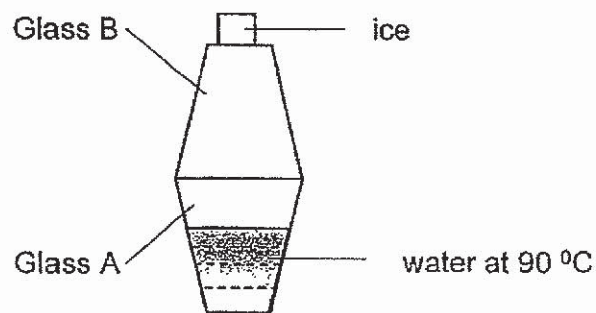

Why did Timothy place an ice cube on glass B?

- ( 1 ) To increase rate of melting
- ( 2 ) To increase the rate of evaporation
- ( 3 ) To increase the rate of condensation
- ( 4 ) To increase rate of heat loss in glass B

( )

18. The table below shows the temperature changes of two different substances, P and Q, over time. The room temperature is 30°C.

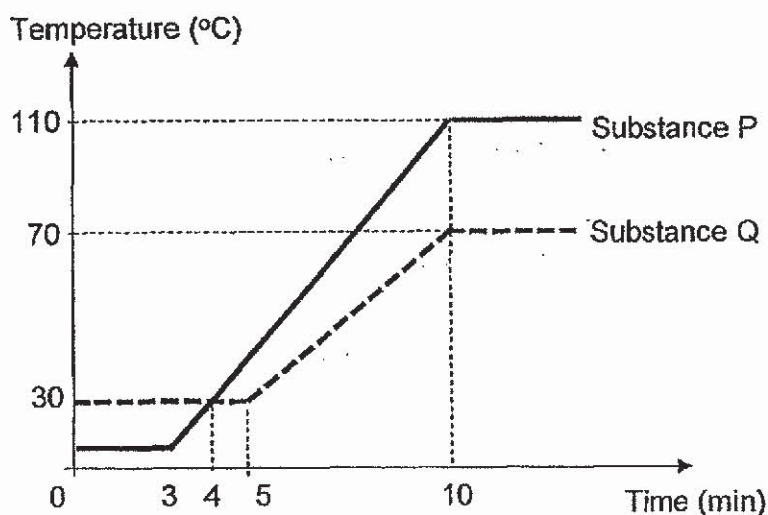

Based on the graph above, which of the following statements are correct?

- A. Q is a solid and a liquid at room temperature.
- B. Both P and Q were liquids at 4 minutes.
- C. The melting point of Q is higher than P.
- D. Both P and Q started to boil at 10 minutes.

- (1) A and C only
- (2) C and D only
- (3) A, C and D only
- (4) All of the above

( )

19. Study the diagram below.

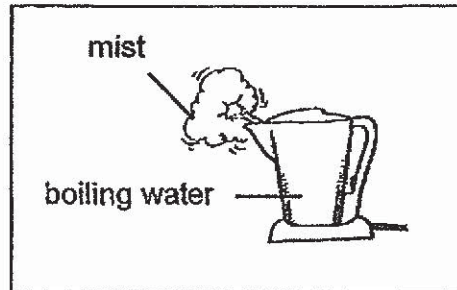

Which statements describe the mist formed?

- A: It is made up of water vapour.
- B: It is made up of water droplets.
- C: It is formed by water evaporating into the surrounding air.
- D: It is formed by water vapour losing heat to the surrounding air.

- (1) A and C only
- (2) B and C only
- (3) A and D only
- (4) B and D only

( )

20. Study the table below.

Substance	State of substance at		
	80°C	100°C	120°C
A	solid	solid	solid
B	solid	solid	liquid
C	liquid	liquid	gas

Which one of the following is correct?

- ( 1 ) Substance A has the lowest melting point.
- ( 2 ) The boiling point of Substance B is 120°C.
- ( 3 ) Substance B has a higher melting point than Substance C
- ( 4 ) All three substances are solid at 30°C.

( )

21. Nor placed blocks X and Y into two identical containers, A and B. He then filled both the containers with water until both blocks are fully submerged.

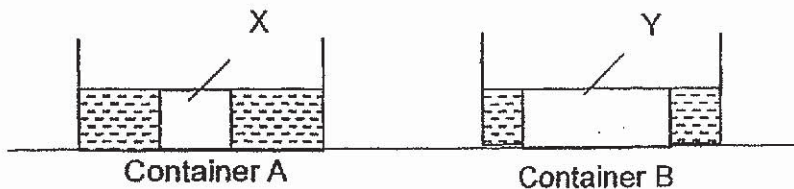

Nor observed that less water filled container B. Which of the following correctly explains why less water filled container B?

- ( 1 ) Block Y has more mass.
- ( 2 ) Block Y has more volume.
- ( 3 ) Water has no fixed shape.
- ( 4 ) Water cannot be compressed.

( )

22. Vincent was cooking a piece of meat. He left the meat on the grill for a short period of time before removing it. He observed black burnt lines on it.

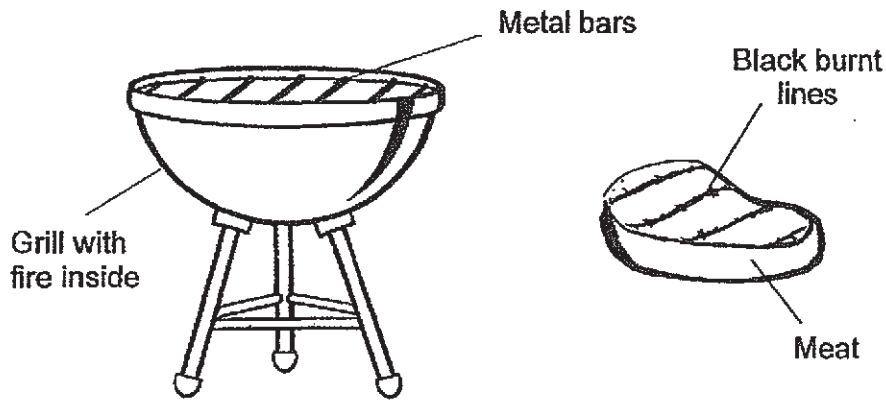

Which one of the following statements best explains the presence of the black burnt lines on the meat?

- ( 1 ) The fire was too strong.
- ( 2 ) The meat lost heat to the metal bars.
- ( 3 ) The metal bars conducted heat quickly.
- ( 4 ) The metal bars gained heat from the hot meat.

( )

23. Study the diagram below.

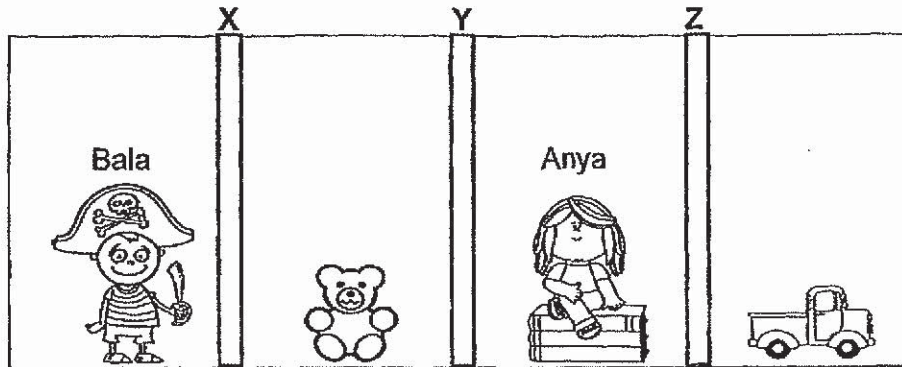

Two children and two of their toys are separated by screens, X, Y and Z. Given that the screens are made of different materials,

- Bala is unable to see Anya.
- Anya can see both the teddy bear and the toy truck.

Which one of the following could possibly be the materials of the screens?

	X	Y	Z
(1)	clear glass	metal	clear plastic
(2)	wood	clear plastic	clear glass
(3)	clear plastic	clear glass	black cloth
(4)	metal	black cloth	wood

( )

24. When the battery is connected in the opposite direction, the poles of the electromagnet will change. Remi connected an iron rod to a battery using some wires. When she placed a magnet beside the iron rod, she observed that the magnet was pushed away from it.

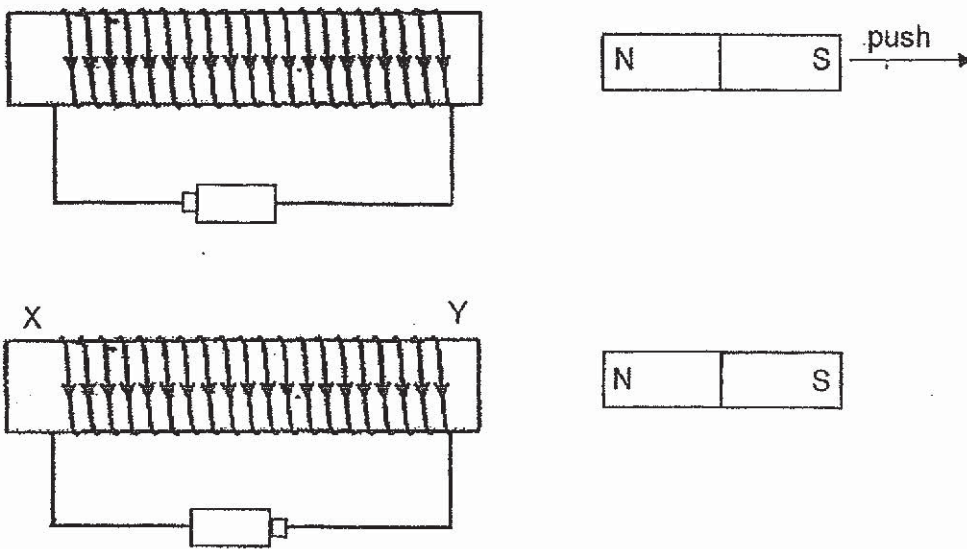

If Remi changes the battery in the opposite direction, what will be the poles of the electromagnet, X and Y, and how will the magnet move?

	X	Y	Magnet
(1)	N	S	push
(2)	S	N	push
(3)	N	S	pull
(4)	S	N	pull

( )



25. Mike is in an enclosed bath room. He poured tap water at  $30^{\circ}\text{C}$  on some hot stones, which are at a temperature of  $150^{\circ}\text{C}$ . The heat source keeps the stones at  $150^{\circ}\text{C}$ .

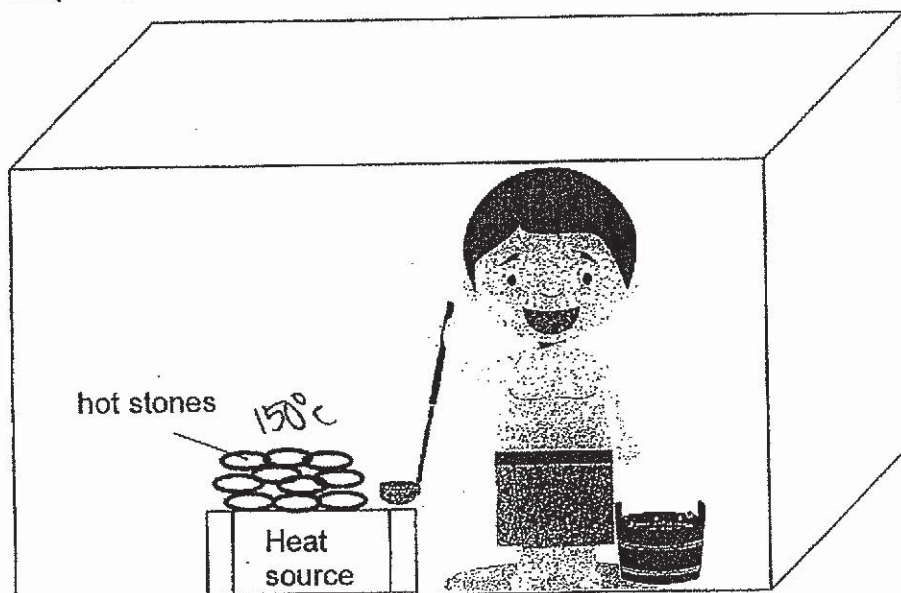

Which one of the following explains the temperature of the room after water is poured on the stones?

	Temperature of the room	Explanation
(1)	decreases	The stones lost heat to the water and became cooler.
(2)	decreases	The surrounding air lost heat to the cooler stones and became cooler.
(3)	increases	Water gained heat from the stones and became hot water vapour.
(4)	increases	The surrounding air gained heat from the water and became warmer.

( )

26. Suresh used 2 similar batteries and 1 bulb to form circuits, A,B,C and D.

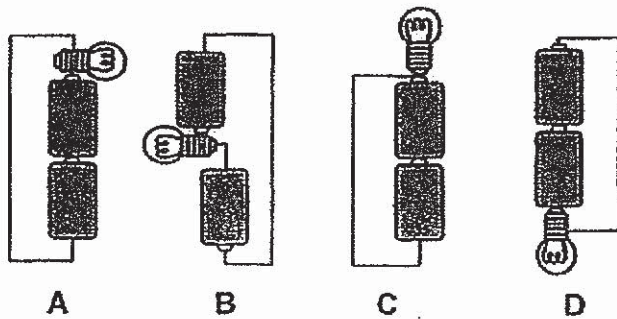

Which of the circuits would the bulb not light up?

- (1) A and C only
- (2) A and D only
- (3) B and C only
- (4) B and D only

( )

27. An electrician installed bulbs A, B, C and D to light up a mirror shown below. All the bulbs lit up when the circuit was closed.

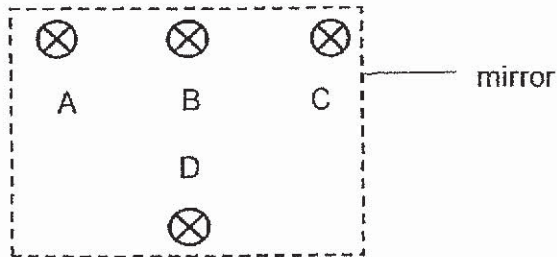

He removed one light bulb from the circuit each time and recorded his results in the table below.

Bulb removed	Bulb(s) lit
A	None
B	A and D
C	A and D
D	A, B and C

Which of the circuits shows the connection of the bulbs?

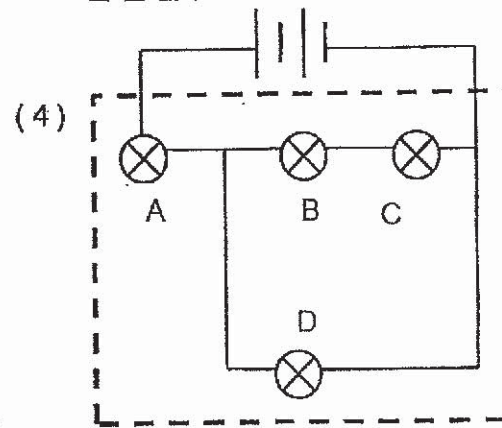
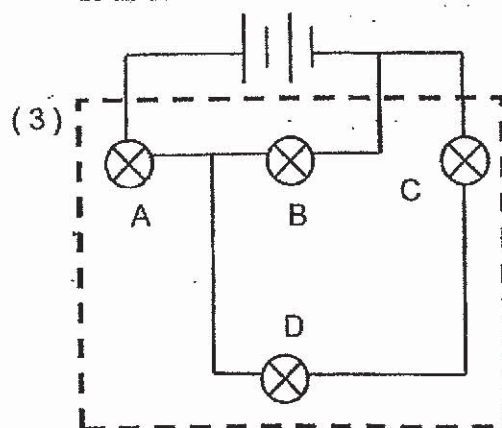
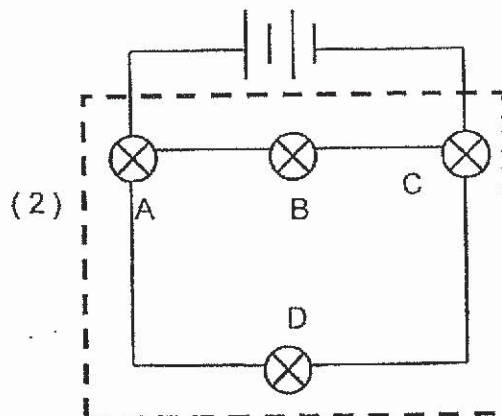
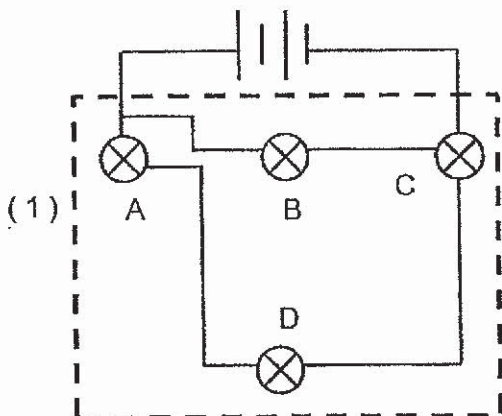

( )

28. Penny tried to lift an object from the ground. Positions A, B and C show three different positions of the object.



Position A



Position B



Position C

Which of the following correctly describes the weight and gravitational potential energy of the object from Position A to Position C?

	<b>Weight</b>	<b>Gravitational Potential Energy</b>
( 1 )	remains the same	remains the same
( 2 )	increases	increases
( 3 )	remains the same	increases
( 4 )	increases	remains the same

( )

~ End of Section A ~



**RIVER VALLEY PRIMARY SCHOOL**  
**2019 SEMESTRAL ASSESSMENT 1 (SA1)**  
**PRIMARY 6**

**STANDARD SCIENCE**

**(BOOKLET B)**

Name : \_\_\_\_\_ (    )

Date : 22/05/2019 (Wed)

Class : P6 \_\_\_\_\_

Time : 1 hour 45 min

**INSTRUCTIONS TO CANDIDATES**

1. Write your name, index number and class in the space above.
2. Do not turn over this page until you are told to do so.
3. Follow all instructions carefully.
4. Answer all questions.
5. For Section A, shade your answers for questions 1 to 28 on the OAS.
6. For Section B, write your answers for questions 29 to 40 in the space provided.
7. The total marks for Booklet B is 44 marks.

Booklet A	56
Booklet B	44
Total	100

Parent's Signature: \_\_\_\_\_



**Section B (44 marks)**

Write your answers to questions 29 to 40 in this booklet.

29. The diagram below shows plants of different height growing in a rainforest.

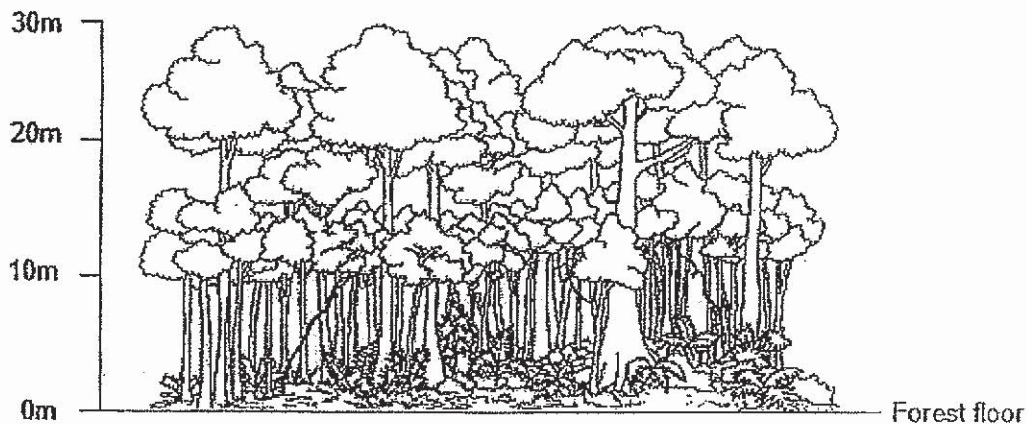

An investigation was carried out to measure the amount of light received at two different heights from the forest floor. The results are shown in the table below.

Height above the forest floor (m)	Average amount of sunlight received by the plants (lux)	Average increase in mass of the plants (units)
10	100	10
30	1000	100

The plants at 10m above the forest floor increased slower in mass than the plants found at 30m above the forest floor. Give a reason. [2m]

---

---



30. Beryl designed a wheel toy for her hamster as shown in the set up below.

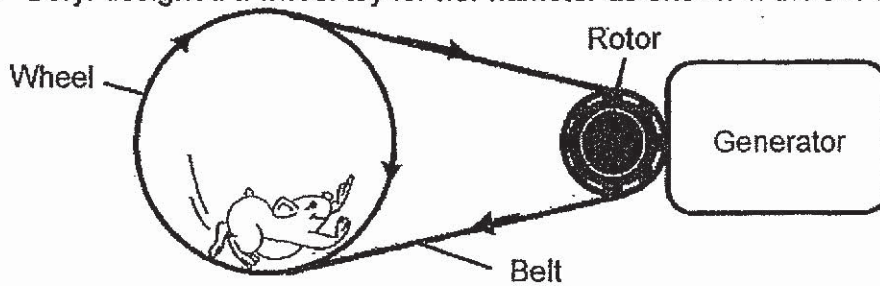

As the hamster ran on the wheel, the wheel started to spin causing the belt to also move. The rotor started to turn, which was connected to a generator.

(a) Fill in the blanks below to show the energy conversion. [2m]

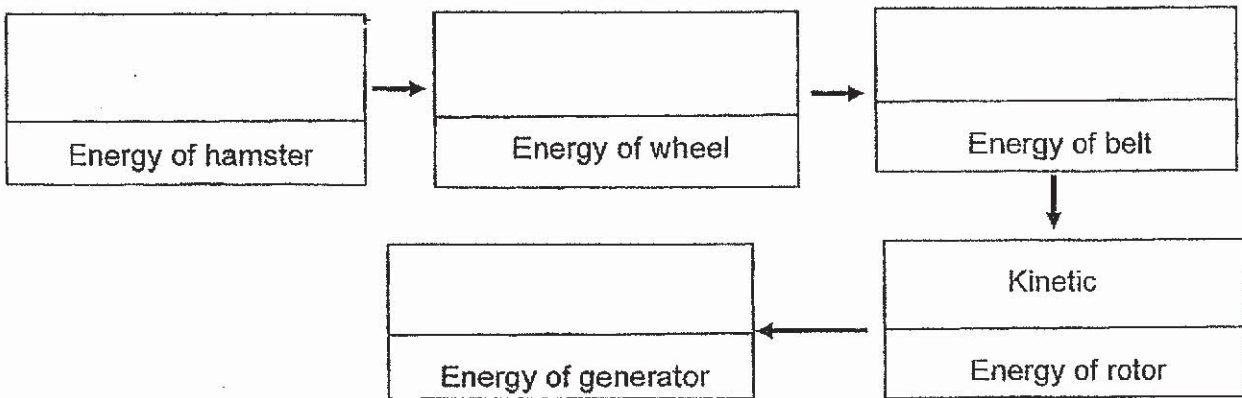

A bulb was then connected to the generator.

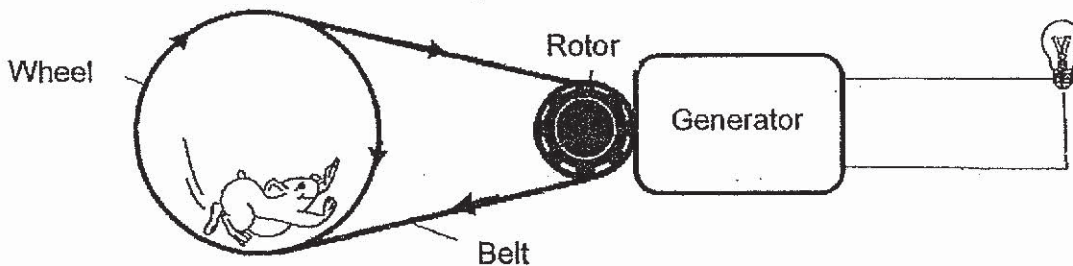

(b) Beryl noticed that the bulb did not light up when the hamster started to run on the wheel. All the components in set up were in working condition. Explain why. [2m]

---



---

31. Alaff set up an experiment to determine how well duckweeds grow in different water conditions. Water samples were taken from 2 different locations, X and Y. He placed an equal number of duckweeds in beakers A and B.

After one week, he observed the duckweeds and represented his findings in the table below.

	Beaker A	Beaker B
Location where water is taken from	X	Y
Observation of number of duckweeds	Increase by a little	Increase by a lot

(a) Which water sample, X or Y, is most likely to be from muddy water? Explain your answer. [1m]

---



---

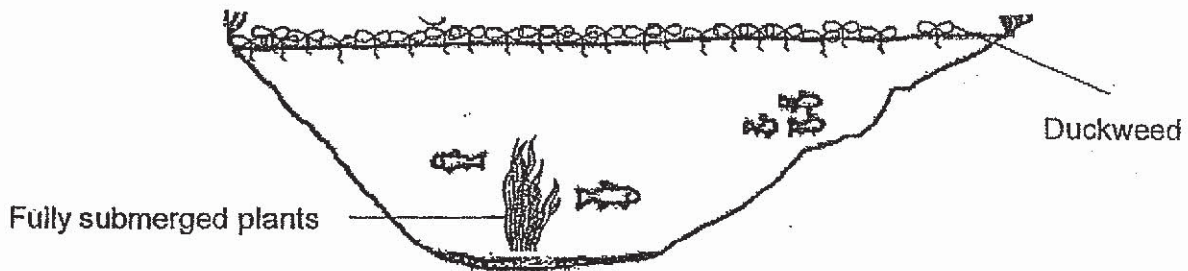

(b) Study the diagram above. Explain how too many duckweeds is harmful to fully submerged plants in the water. [2m]

---



---



---

32. The table below shows the food relationships among the organisms living in community X.

Relationships among organisms in community X
• A feeds on D
• E feeds on A and B
• D contains chlorophyll
• A is the only prey for C
• C is a carnivore that is not a prey of any organism in the community

(a) Based on the information above, complete the food web as shown in the box below. [2m]

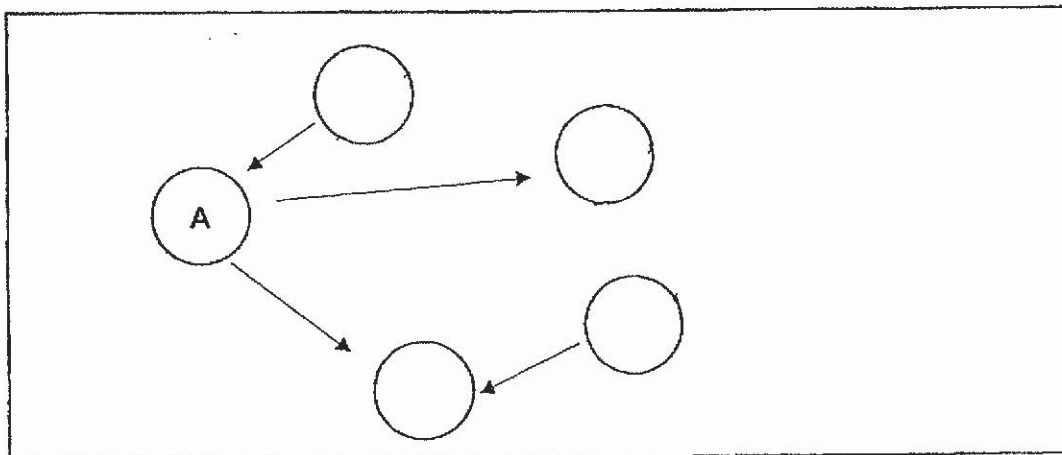

(b) State how the population of organisms C and D will be affected if the population of organism A decreases. Give a reason for your answer. [2m]

Organism C: \_\_\_\_\_

\_\_\_\_\_

Organism D: \_\_\_\_\_

\_\_\_\_\_

	4
--	---

33. (a) State the difference between structural and behavioural adaptation in animals. [1m]

---

---

A koala has both thick fur and thin fur on different parts of its body. Thick fur traps more air than thin fur. The temperature of the tree trunk is lower than the temperature of the surrounding air.

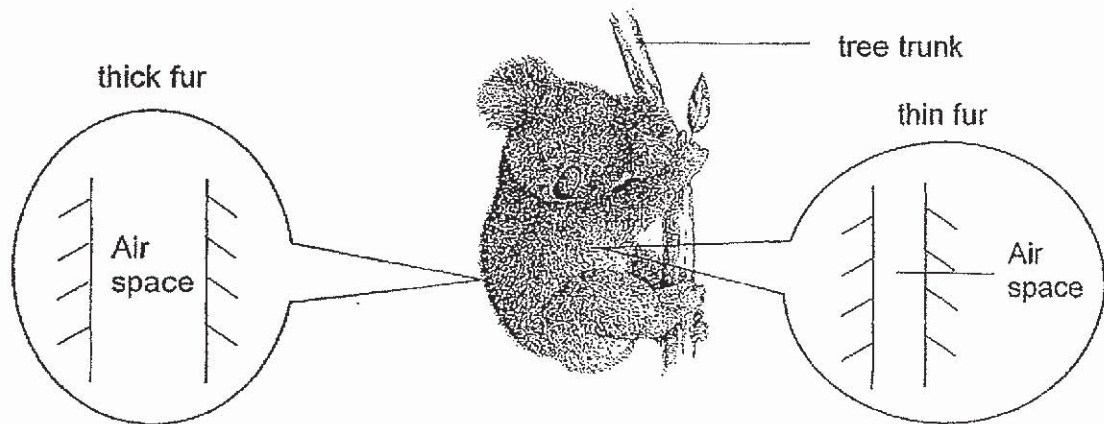

(b) On a warm day, the koala hugs the tree trunk as shown in the diagram below. Explain why the koala bear behaves in this way on a warm day. [2m]

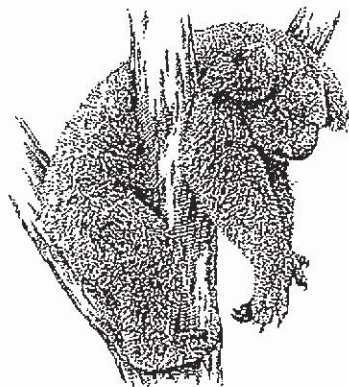

---

	3
--	---

34. The diagram below shows the nests built by Bird X and Y.

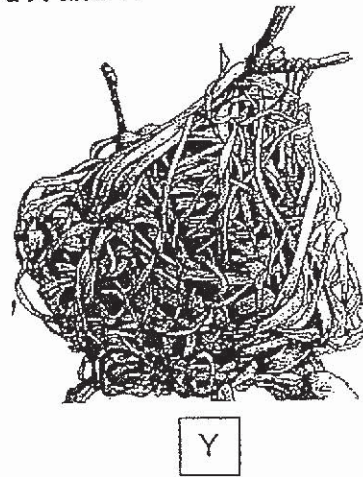
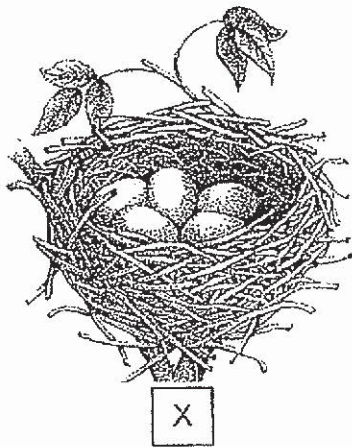

- (a) Based on the diagrams above, which bird has built a nest that is advantageous for its young on a rainy day? Explain your answer. [1m]

---

---

Predatory birds fly from a great height and feed on eggs of birds like X and Y.

- (b) How does the structure of the nest increase the survival rate of the eggs of Bird Y? Explain your answer. [2m]

---

---

---

	3
--	---

Organism G often gets preyed on by bigger fish. Thus, Organism G will hide among the poisonous tentacles of Organism H and move in between the tentacles. This will attract bigger fish to swim towards Organism H as Organism H is not able to move from place to place.

When the bigger fish touch Organism H's poisonous tentacles, they will be stung and they cannot move. The bigger fish will be stuck to Organism H.

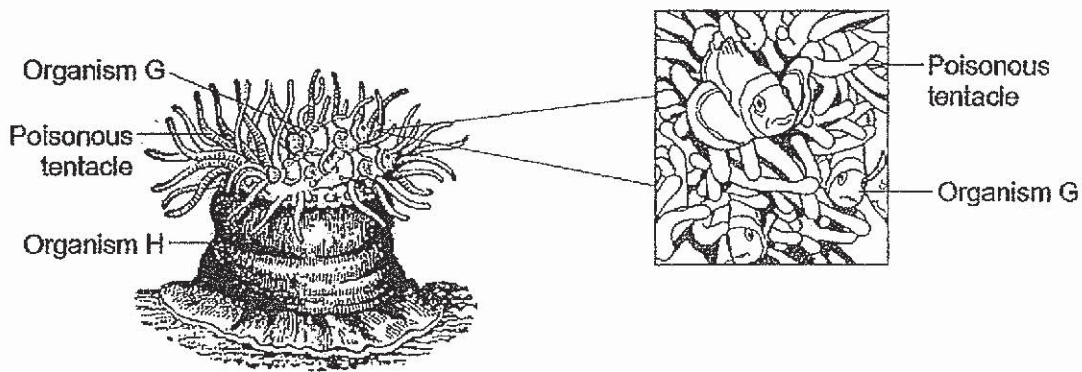

- (c) Based on the information above, explain how Organism G and Organism H depend on each other. [2m]

---

---

---

35. The diagram below shows how blood travels in our body.

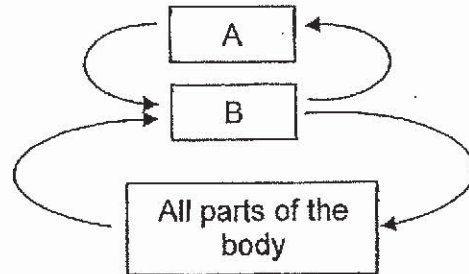

(a) Name the organs which A and B represent [1m]

Organ A: \_\_\_\_\_

Organ B: \_\_\_\_\_

The diagrams below show a healthy blood vessel and a narrowed blood vessel. Narrowed blood vessels leave a smaller opening for blood to flow through.

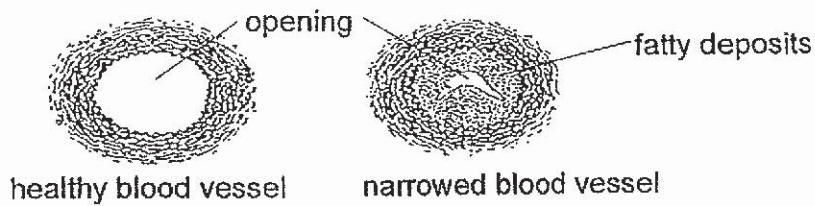

The table below shows the heart rate of two volunteers at rest and while jogging.

Volunteer	Heart rate (beats per minutes)	
	At rest	While running
X	70	100
Y	80	125

	1
--	---

(b) Why do the volunteers have higher heart rate while running than at rest? [1m]

---

---

(c) Based on the information above, which volunteer, X or Y is most likely to have a narrowed blood vessel? Explain your answer. [2m]

---

---

	3
--	---



36. Maverick hit the ball gently at A before using more force to hit it into the net at B as shown below.

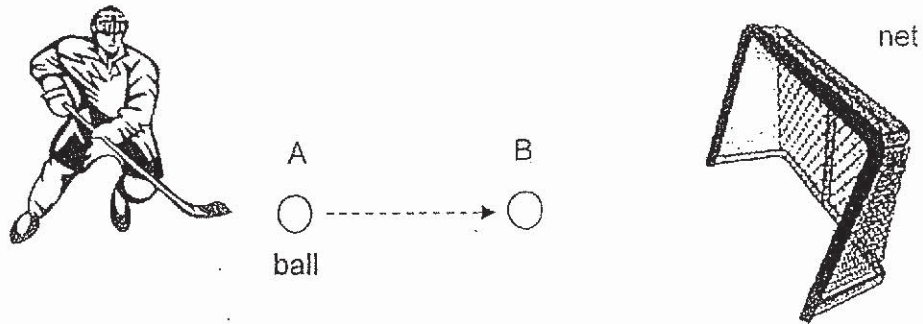

(a) State the effect of more force on the moving ball at B. [1m]

---

(b) Name two forces acting on the ball. [1m]

---

(c) The net is connected to an electrical scoring system that updates the score when the ball touches the net. Suggest a material for the ball so that the system can work. Explain your answer. [2m]

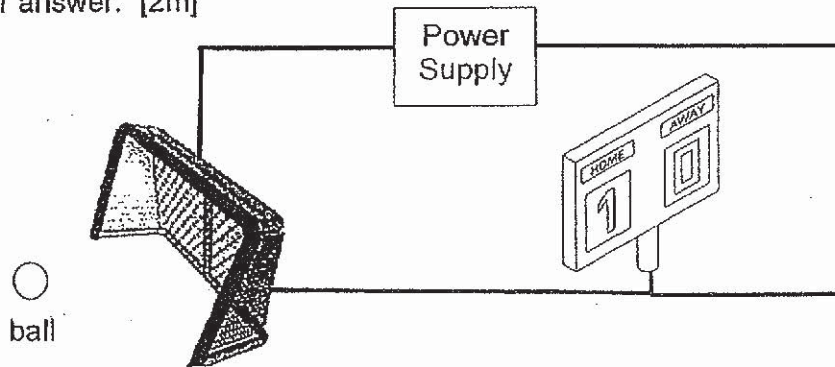



---

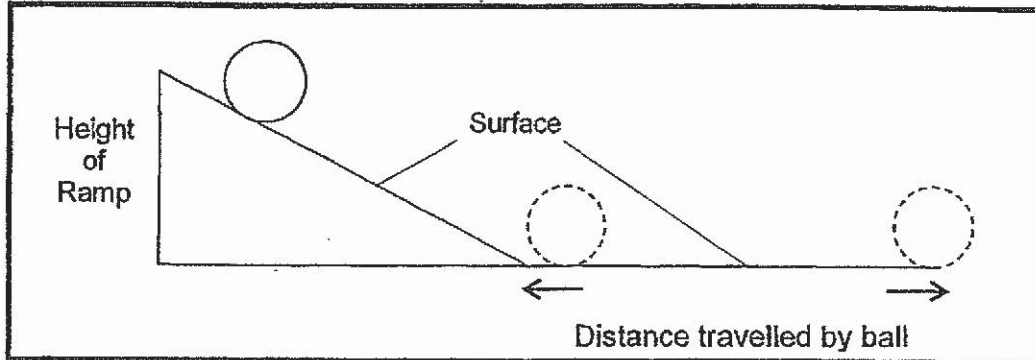

---

37. Indu carried out the experiment below using a ball and different surfaces.



She measured and recorded the distance travelled by the two balls on the ground.

	Distance travelled on Surface A	Distance travelled on Surface B
1 <sup>st</sup> try	60 cm	11 cm
2 <sup>nd</sup> try	62 cm	16 cm
3 <sup>rd</sup> try	64 cm	12 cm
Average	62 cm	13 cm

The two surfaces are shown in the diagrams below.

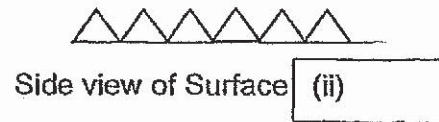

(a) Based on the results above, identify the side view of surface A and B. Write the correct letter A or B in the blanks (i) and (ii) above. [1m]

(b) Give a reason why the ball rolled for a shorter distance on surface B. [1m]

---



---

(c) Without changing the ball, name two other ways to make the ball move further. [2m]

---

---

(d) Indu concluded that friction is a force. Do you agree? Explain your answer. [1m]

---

---

	3
--	---

38. Miss Tan wanted to find out how the length of two springs, A and B, change when different masses were attached.

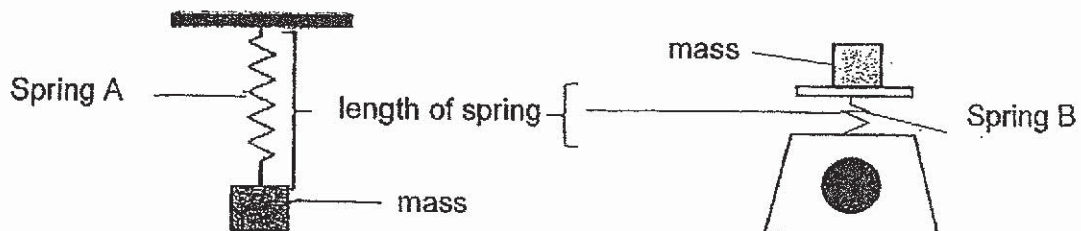

She measured the lengths of Springs A and B each time a mass was added. The graphs below show the results of the experiment.

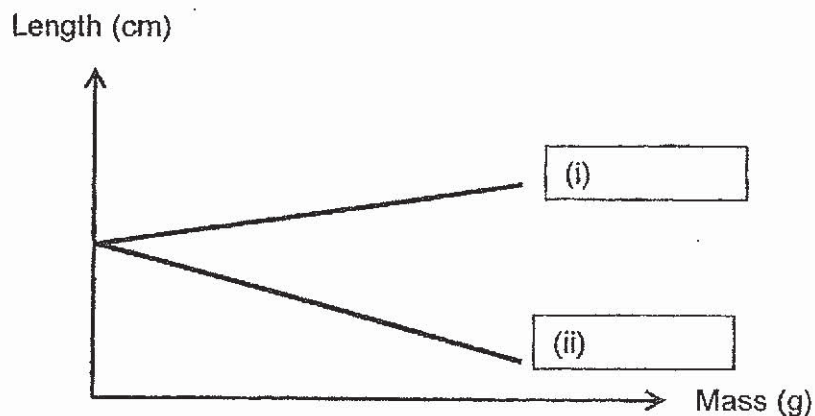

- (a) Identify on the graph Spring A and B by indicating A or B in the space above. [1m]

	1
--	---

- (b) As shown below, Miss Tan drew the direction of gravity acting on the mass as it was placed on Spring B.

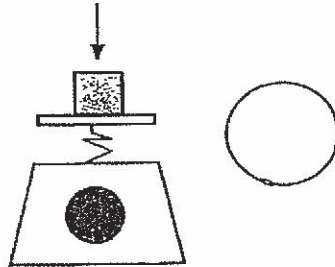

Draw the direction of elastic force of Spring B in the circle -  above. [1m]

- (c) Miss Tan placed the following object of mass 130g on Spring B and found that the mass was different, as shown below.

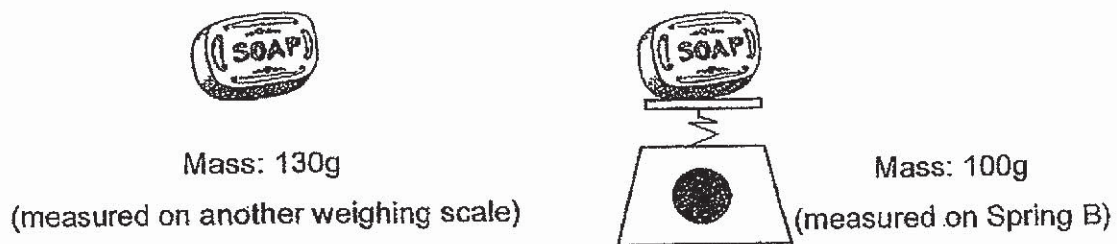

Explain why the mass was different on Spring B. [2m]

---

---

39. The machine shown below is used to check if a parcel is too heavy.

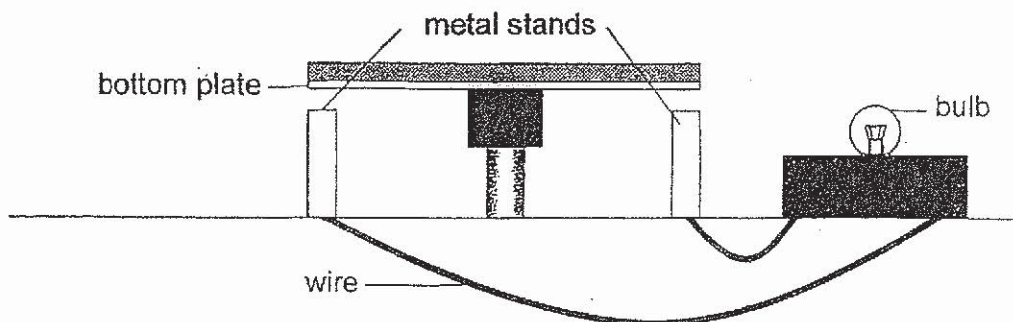

When an overweight parcel is placed on the machine, it pushes the bottom plate down fully, causing it to touch the metal stands. The bulb will then light up as shown below.

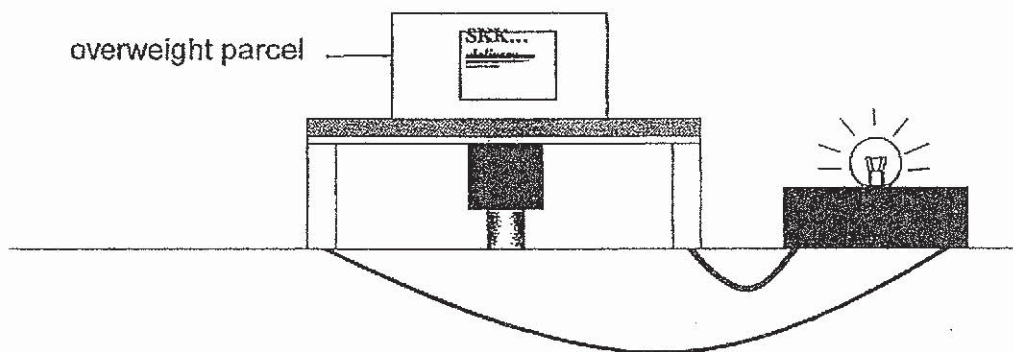

(a) Explain why the bulb does not light up when a parcel that is too light is placed on the machine. [1m]

---

---

(b) A disadvantage of the machine is that it might still allow overweight parcels to pass through. Explain why the above situation is possible. [1m]

---

---

(c) A second bulb is added in parallel so that the machine stops overweight parcels from passing through. Explain how this will stop overweight parcels. [1m]

---

---





Noel injured his knee during soccer practice and he used a spray with a cooling effect to numb his pain.



(b) Which of the liquids, A, B or C, would be the most suitable for the spray? Explain your answer. [2m]

---

---

~ End of Paper ~



**SCHOOL : RIVER VALLEY PRIMARY SCHOOL**  
**LEVEL : PRIMARY 6**  
**SUBJECT : SCIENCE**  
**TERM : 2019 SA1**

**SECTION A**

Q 1	Q2	Q3	Q4	Q5	Q6	Q7	Q8	Q9	Q10
2	2	4	1	2	1	3	1	1	3
Q 11	Q12	Q13	Q14	Q15	Q16	Q17	Q18	Q19	Q20
3	3	2	2	4	2	3	3	4	3
Q 21	Q22	Q23	Q24	Q25	Q26	Q27	Q28		
2	3	2	3	3	1	4	3		

**SECTION B**

Q29)	Plants found at 30m received more sunlight. Thus, they were able to photosynthesize at a greater rate.
Q30)	<p>a) Kinetic → Kinetic → Kinetic</p> <p style="text-align: center;">↓</p> <p style="text-align: center;">Electrical ← Kinetic</p> <p>b) The hamster did not run fast enough to convert kinetic energy to electrical energy to light up the bulb.</p>
Q31)	<p>a) Water does not contain enough nutrients to photosynthesis for the plant to grow.</p> <p>b) The weeds prevent sunlight from reaching the bottom of the lake. With less sunlight, fully submerged plants have slower rate of photosynthesis and make less food.</p>

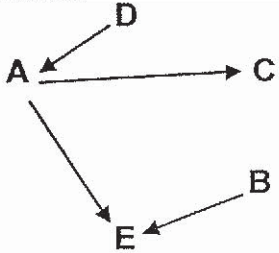
<p>Q32)</p>	<p>a)</p>  <pre> graph TD     D --&gt; A     A --&gt; C     A --&gt; E     B --&gt; E </pre> <p>b) Organism C : When the population of organism A decreases, C has not enough food to feed on organism A. Hence, the population of organism C will decrease.</p> <p>Organism D : The population of organism D will increase as there will be lesser organism A to feed on organism D.</p>
<p>Q33)</p>	<p>a) The structural adaptation is what an animal has but behavioural adaptation is how an animal behaves in its environment.</p> <p>b) Most of the thin fur is in contact with the tree to lose heat faster from the body to the tree. Thick fur reduces heat gain from surrounding air.</p>
<p>Q34)</p>	<p>a) Bird Y. The young of bird Y has shelter and will not get wet on a rainy day.</p> <p>b) The structure of the nest helps the birds to hide from predators so that they will not be seen easily. Hence, the structure of the nest increases the survival rate of the eggs of bird Y.</p> <p>c) Organism G can use Organism H's poisonous tentacles to scare away predators and reduce chances of predators preying on it. Since organism H cannot move from place to place, Organism G helps to attract H to get food.</p>
<p>Q35)</p>	<p>a) C</p> <p>Org. heart</p> <p>b) When they are running, the body cells require more oxygen and digested food to produce more energy. There is a higher heart rate to produce more oxygen and digested food to the muscle cells.</p>

Q35)	c) Volunteer Y. The heart rate beating per minute is faster than volunteer X, so volunteer Y have to breathe more to transport more oxygen and digested food to the muscle cells.
Q36)	<p>a)When there is more force, the ball will move faster.</p> <p>b)Gravitational force and frictional force.</p> <p>c)Iron. Iron is a good conductor of electricity, so electric current can flow through the circuit to update the score.</p>
Q37)	<p>a)i)A    ii)B</p> <p>b)Surface B is rougher and thus, has more friction so a greater force is needed to overcome the friction between the ball and the surface, so it moved a shorted distance.</p> <p>c)Put lubricants such as oil on the surface and change the ramp to a smoother ramp such as iron. Raise the ramp.</p> <p>d)Yes. Friction opposes the motion of the object and changes direction.</p>
Q38)	<p>a)i)A    ii)B</p> <p>b) </p> <p>c)Spring B is too stiff and not easily compressed so the mass is lower.</p>
Q39)	<p>a)When the parcel is too light, the bottom plate will not touch the metal stands . This creates an open circuit and electric current cannot pass through the bulb.</p> <p>b)The fuse will be fused.</p> <p>c)If the circuit is closed, current can still flow through the other bulb.</p>

<b>Q40)</b>	<b>a)Liquid C. The temperature is the lowest and the water will evaporate slower.</b> <b>b)Liquid B. The thermometer reading increased the fastest. This allows the knee to lose heat the fastest and liquid B gains heat fastest to cause cooling.</b>

