



Rosyth School
Preliminary Examination 2024
SCIENCE
Primary 6

Name: _____

Total

Marks:

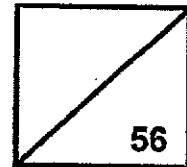

Class: Pr 6 _____

Register No. _____

Date: 22 August 2024

Duration: Total time for Booklets A and B: 1 h 45min

Booklet A

Instructions to Pupils:

1. Please do not turn this page until you are told to do so.
2. Follow all instructions carefully.
3. Answer all questions.
4. Use a 2B pencil to shade your answers on the Optical Answer Sheet (OAS) provided.

This booklet consists of 23 printed pages (including this cover page).

For each question from 1 to 28, four options are given. One of them is the correct answer. Make your choice (1, 2, 3 or 4) and shade your answer on the Optical Answer Sheet (OAS). [56 marks]

- 1 Which one of the headers can group the six animals into two groups, 1 and 2, with same number of animals in each group?

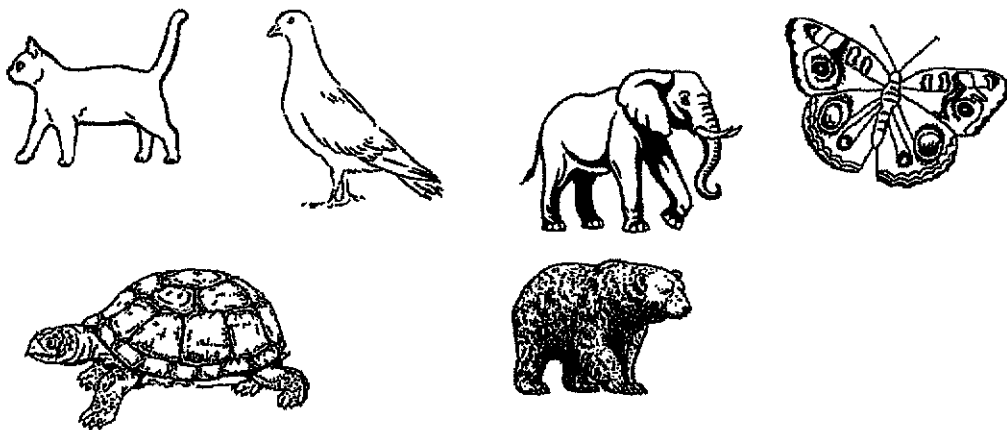

Identify suitable headers for Groups, 1 and 2.

	Group 1	Group 2
(1)	Covered with scales	Covered with hair
(2)	Lays eggs	Gives birth to young alive
(3)	Has a three-stage life cycle	Has a four-stage life cycle
(4)	Does not have four legs	Has four legs

- 2 Study the picture of an animal cell.

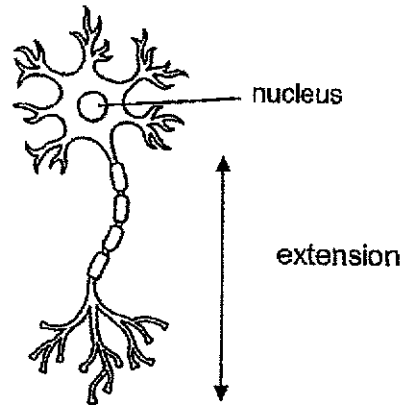

Which of the following is the correct reason for the above to be classified as an animal cell?

- (1) It has a nucleus.
- (2) It has a long extension.
- (3) It does not have a cell wall.
- (4) It does not have a chloroplast.

- 3 The diagram below shows a plant.

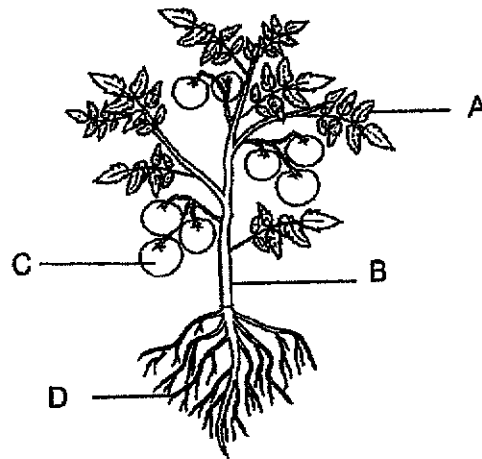

Identify which part of the plant, A, B, C or D, holds the plant upright.

- (1) A
 (2) B
 (3) C
 (4) D
- 4 Which of the following shows the correct direction that digested food takes after it passes through the mouth?
- (1) Stomach → small intestine → blood stream
 (2) Stomach → small intestine → large intestine
 (3) Gullet → stomach → small intestine → large intestine
 (4) Gullet → stomach → small intestine → blood stream

5 Blood flows through blood vessels A to D as shown.

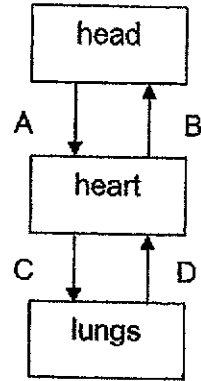

Which blood vessels transport blood richer in oxygen?

- (1) A and B
- (2) C and D
- (3) A and C
- (4) B and D

- 6 The diagram below shows how various substances are transported in the human body.

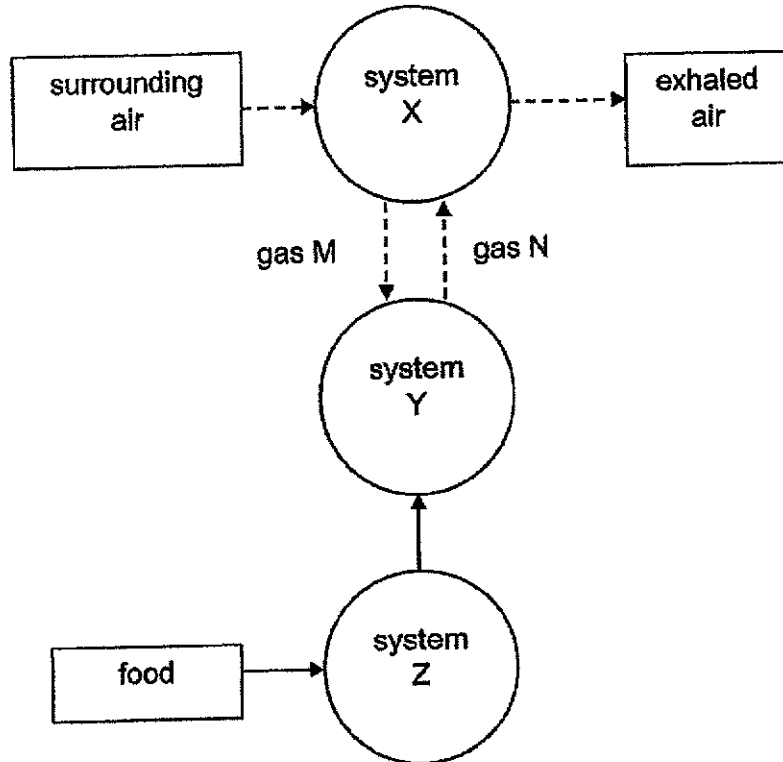

Which of the following statements are true?

- A: Gas M is oxygen.
- B: System Y is involved in gaseous exchange.
- C: System Z is involved in absorption of simple substances.

- (1) A and B only
- (2) A and C only
- (3) B and C only
- (4) A, B and C

7 Which one of the following is similar for a grasshopper and a frog?

- (1) six legs
- (2) three-stage life cycle
- (3) young looks like the adult
- (4) lives both on land and in water

8 An experiment was conducted on some green bean seeds.

Seeds were put in the soil of each set-up.

The table below shows the conditions of the set-ups used.

Set-up	Condition of soil	Presence of light	Temperature (°C)
A	damp	yes	25-30
B	damp	yes	below zero
C	damp	no	25-30

Which of the set-up/s would have seeds germinating after a few days?

- (1) A only
- (2) A and C only
- (3) B and C only
- (4) A,B and C

- 9 The diagram below shows the female reproductive system.

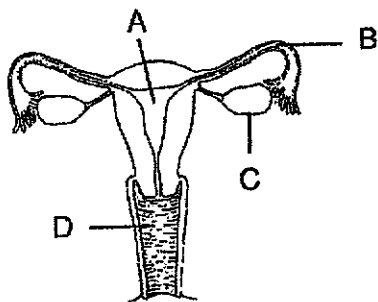

Identify the part where the fertilised egg develops.

- (1) A
- (2) B
- (3) C
- (4) D

10 Plant K's life cycle is shown below.

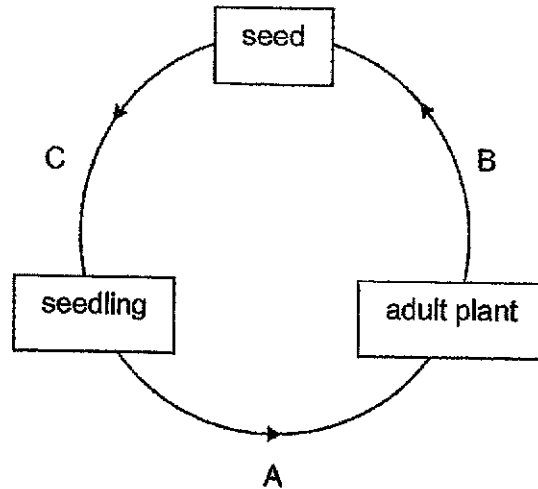

The diagrams below show the seed and flower of Plant K.

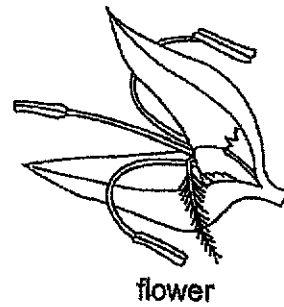
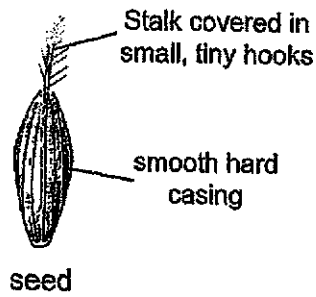

Which processes, A, B or C, require the seed or the flower and what are the agents involved during these processes?

	Seed		Flower	
	Process	Agent	Process	Agent
(1)	C	Animal	A	Wind
(2)	C	Animal	B	Wind
(3)	B	Animal	B	Wind
(4)	B	Wind	B	Animal

11 Aaron conducted an experiment using the set-ups as shown below.

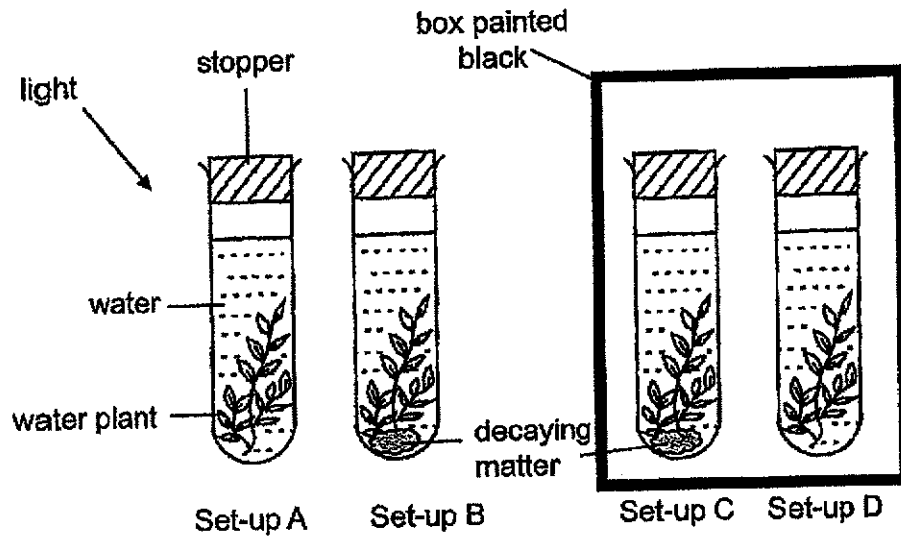

He recorded the change in the amount of carbon dioxide present in each set-up in the graph below.

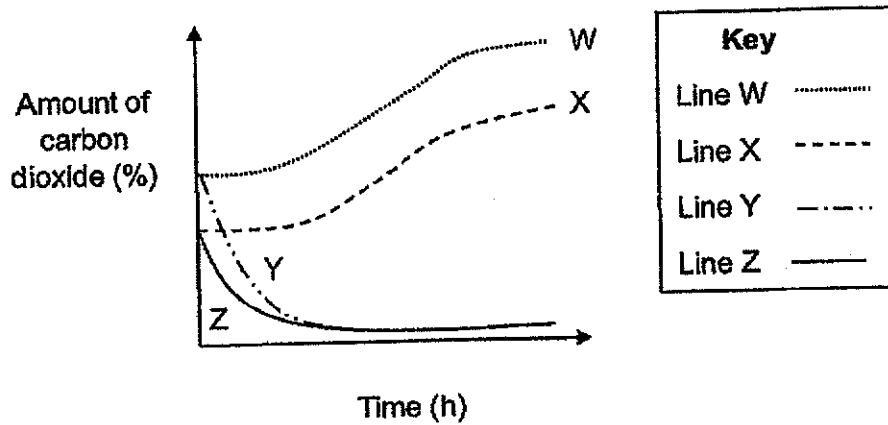

Identify the correct line representing his findings for each set-up.

		Set-up			
		A	B	C	D
(1)	Z	Y	W	X	
(2)	Y	Z	X	W	
(3)	Z	Y	X	W	
(4)	Y	Z	W	X	

12 Which of the following definitely shows the direct transfer of energy in a community of organisms?

- (1) Producer → Prey
- (2) Producer → Predator
- (3) Producer → Plant-eater
- (4) Producer → Animal-eater

13 The diagram below shows a simple food web.

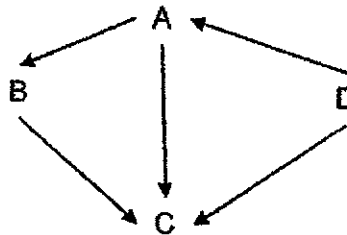

Which one of the following organisms will benefit directly if the level of carbon dioxide in the surrounding increases?

- (1) A
- (2) B
- (3) C
- (4) D

- 14 Bird H is a large bird that makes its nest in the holes in large old trees. It eats fruits, insects, and small reptiles.

As Singapore developed, large areas of forest were cut down and Bird H became locally extinct by 1960.

In 1997, some of Bird H flew over from Malaysia.

Around the year 2000, humans started installing nesting boxes on trees for Bird H.

The graph below shows the percentage of Singapore covered in forest and the estimated population of Bird H over the years.

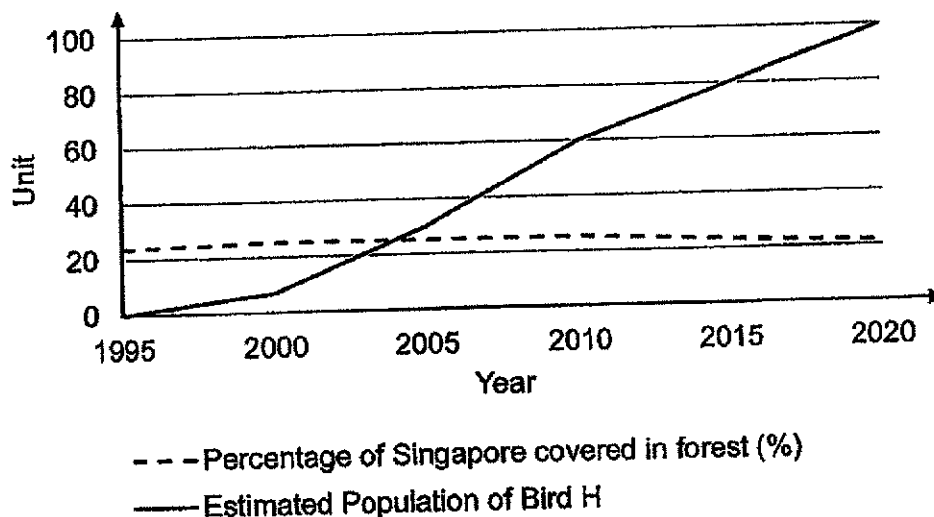

Based on the information provided, identify the reason why Bird H became locally extinct by 1960.

- (1) Not enough food for survival
- (2) No shelter to hide from predators
- (3) Cannot move from place to place
- (4) No suitable place for reproduction

- 15 Sarah wanted to make a simple fire alarm. In the diagram below, when she heated metal strip A, it expanded.

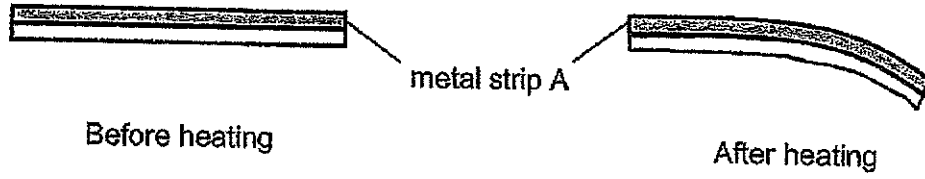

Sarah used metal strip A in her fire alarm. Only when there is a fire, will the siren produce a sound, and the bulb will light up at the same time.

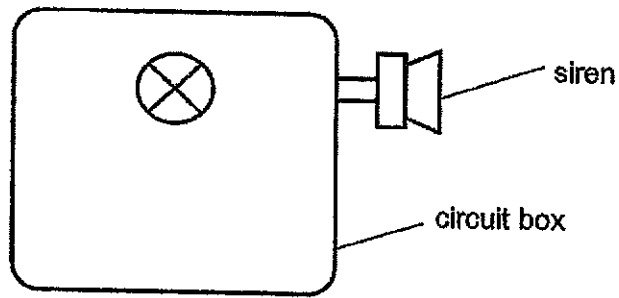

Which of the following shows the correct arrangement of the circuit in the circuit box?

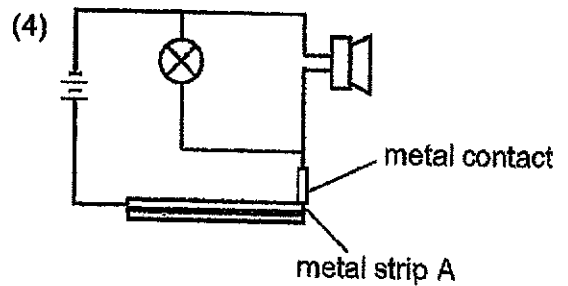
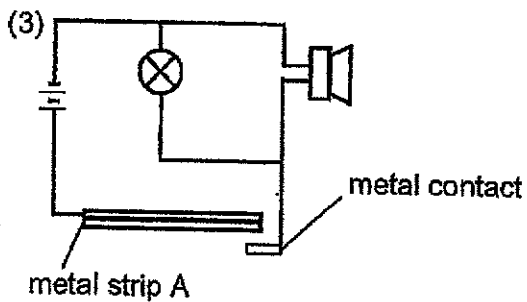
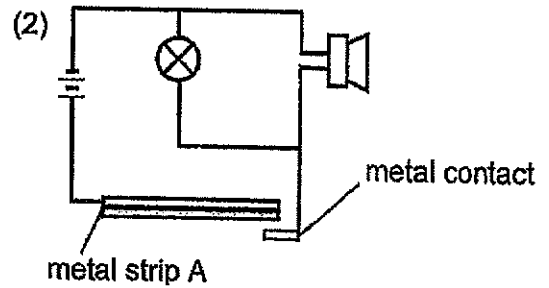
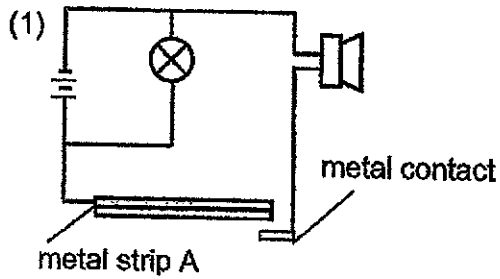

- 16 Alexa placed a bottle of water on the table at room temperature as shown below.

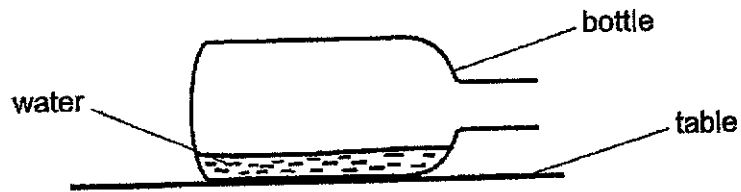

She wanted the water in the bottle to evaporate quickly.

Which of the following should Alexa do to speed up the rate of evaporation?

- (1) Place the bottle on a hot towel
 - (2) Place the bottle in a cupboard
 - (3) Place the bottle on a tray of ice
 - (4) Place the bottle in an upright position
- 17 The diagram below represents the water cycle.

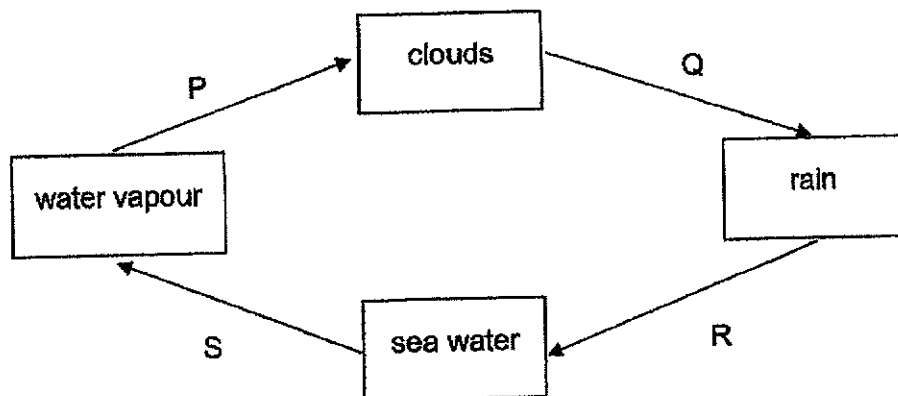

Based on the diagram above, which letter(s), P, Q, R and/or S, involve(s) heat loss?

- (1) P only
- (2) S only
- (3) P and Q only
- (4) R and S only

18 The diagram below shows five cars, A, B, C, D and E.

Due to the differences in the temperature of the air inside the car, water droplets are formed on either the inside or outside of the window.

No water droplet formed on the window of car A.

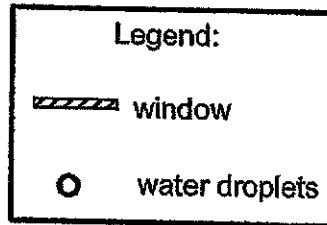
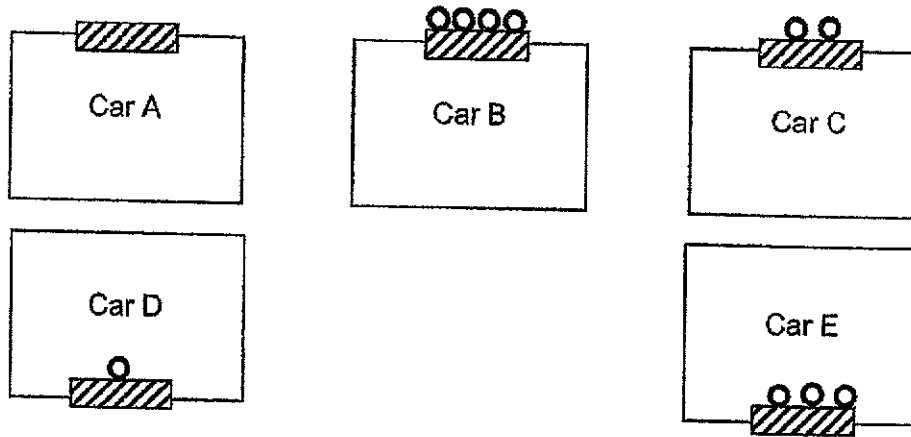

Based on the picture above, which of the following correctly arranges the cars according to their temperature?

Temperature of the air in the car				
	Low	→		High
(1)	B	C	A	E
(2)	E	D	A	B
(3)	E	D	C	B
(4)	B	E	C	D

- 19 The table below shows the melting and boiling points of three substances, P, Q and S.

Substance	Melting point (°C)	Boiling point (°C)
P	45	77
Q	30	66
S	55	90

All three substances are in the same state at _____.

- (1) 35 °C
 (2) 60 °C
 (3) 76 °C
 (4) 80 °C
- 20 Layla placed all her clothes into a bag. She then removed most of the air trapped inside the bag by pushing it out.

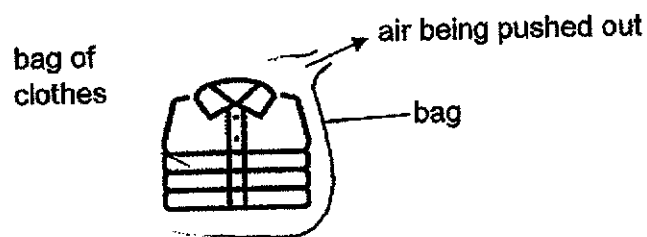

Which of the following shows the changes in the total mass and volume of the bag of clothes after the air was pushed out?

	Total mass of the bag of clothes	Total volume of the bag of clothes
(1)	Remains the same	Decrease
(2)	Remains the same	Remains the same
(3)	Decrease	Increase
(4)	Decrease	Decrease

- 21 Two plates, A and B, are made from different materials. At room temperature, plate B felt much cooler than plate A. Two identical ice cubes were placed on both plates as shown below.

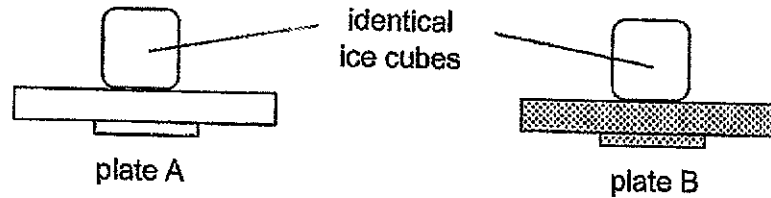

Which of the following correctly matches the ice that melted slower and its reason?

	Plate where ice melted slower	Reason
(1)	A	Plate A is a poorer conductor of heat than plate B.
(2)	A	The ice transferred more heat to Plate A than to plate B.
(3)	B	Plate B is a better conductor of heat than plate A.
(4)	B	The ice transferred coldness to plate B faster than to plate A.

- 22 An incident that took place in a restaurant was reported as shown below.

A man walked into the clean and spotless glass wall that surrounds a restaurant and hurt himself.

The diagram below shows a view of the restaurant.

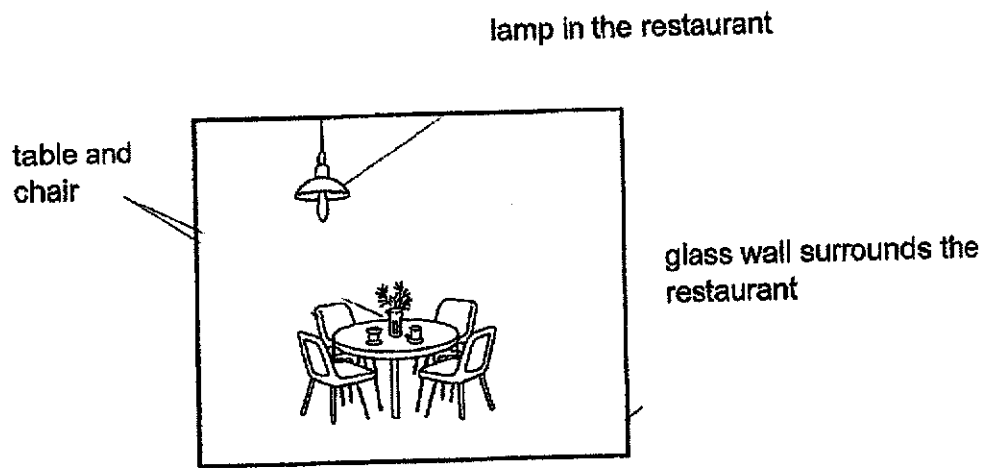

Which of the following best explains why the man walked into the glass wall?

- (1) The light from the lamp entered his eyes.
- (2) The glass wall did not allow light to pass through.
- (3) The glass wall reflected too little light into his eyes.
- (4) The table and chair reflected too much light into his eyes.

- 23 Nancy shone a lighted torch at three different cardboard cut-outs, P, Q and R as shown in the diagram below. She placed these cut-outs at different distances from the torch.

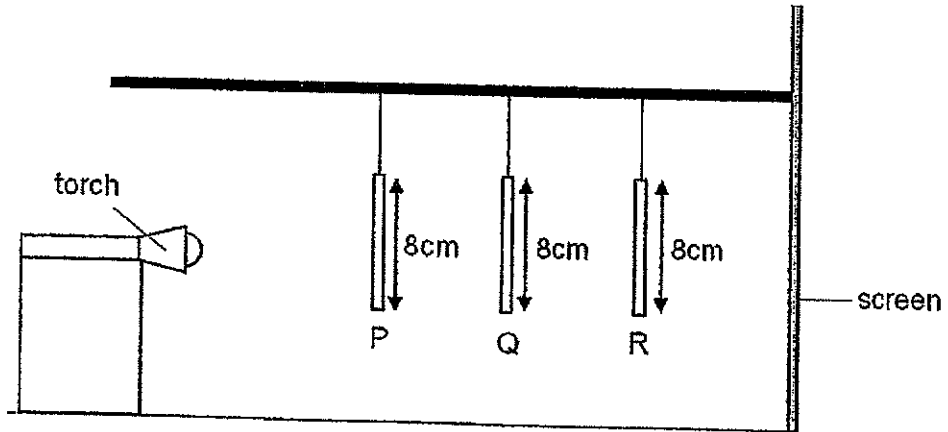

The diagram below shows what she observed on the screen.

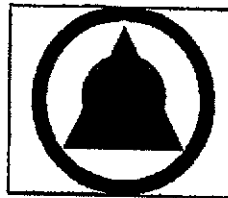

Which of the following correctly represents cut-outs P, Q and R?

	P	Q	R
(1)			
(2)			
(3)			
(4)			

- 24 It was observed that at the moment the boy falling hit the safety net, he bounced upwards as shown below.

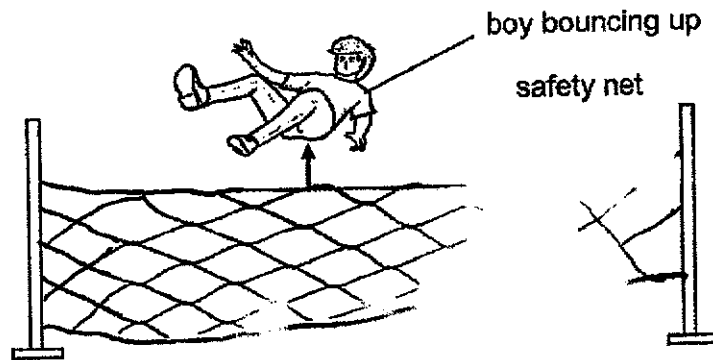

What was the energy conversion for the above observation?

- (1) kinetic energy \longrightarrow heat energy
- (2) kinetic energy \longrightarrow potential energy
- (3) kinetic energy \longrightarrow kinetic energy \longrightarrow potential energy
- (4) kinetic energy \longrightarrow potential energy \longrightarrow kinetic energy

- 25 A mixture of same type of metal pieces and pencil shavings from container X were poured onto the steel rod in the electric circuit shown below.

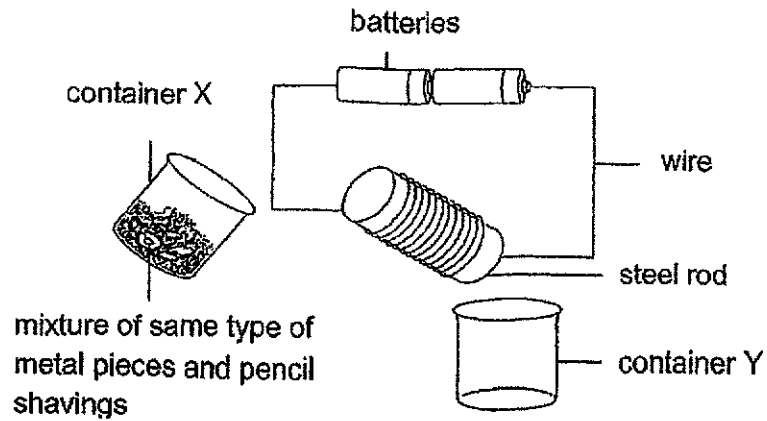

It was observed that only the small metal pieces were attracted to the surface of the steel rod while the larger metal pieces and pencil shavings fell into container Y.

Which one of the statements does **not** explain the above observation?

- (1) The small metal pieces are magnetic.
- (2) The pencil shavings are non-magnetic.
- (3) The large metal pieces are non-magnetic.
- (4) The steel rod has become a temporary magnet.

- 26 Study the diagram below showing two similar bar magnets and two compasses, A and B.

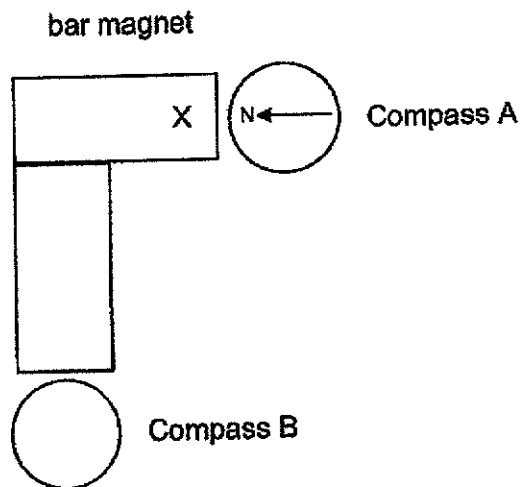

Which one of the following diagrams correctly represents the direction compass B will point to?

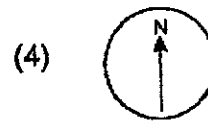
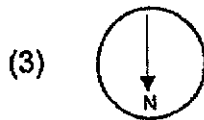
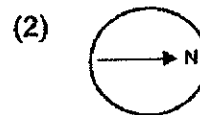
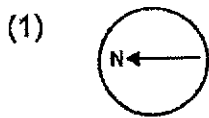

- 27 Which of the following is not an example of the effect of a force?
- (1) Clay is molded into a pot
 - (2) Pollen grains dispersed by wind
 - (3) A footballer stopped a moving ball
 - (4) Light blocked by an opaque object

- 28 A luggage slides down from A to B on a ramp from the storage cabin in an airplane as shown below.

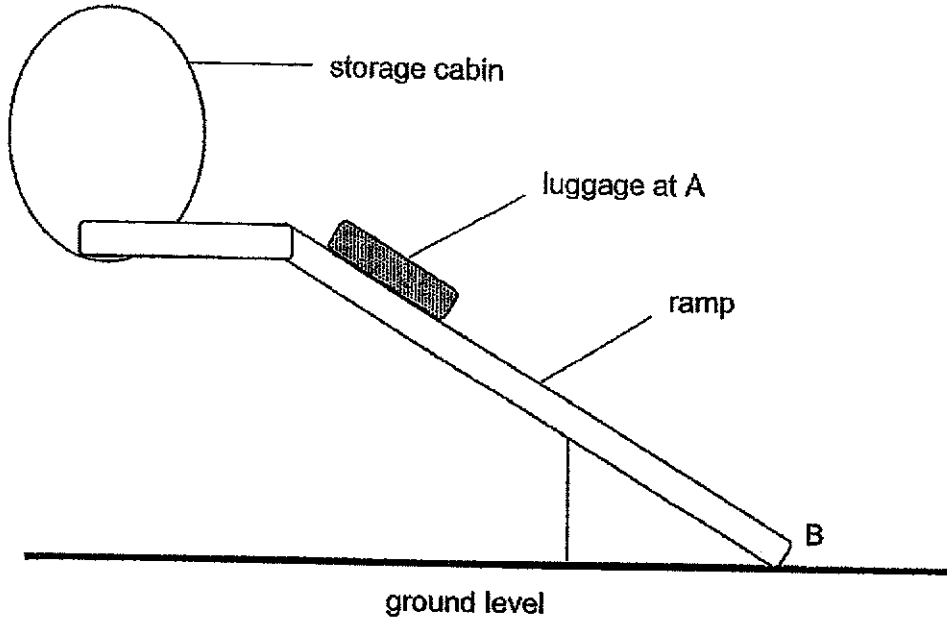

What causes the luggage to slide down by itself from A to B?

- (1) No friction is acting on the luggage.
- (2) No gravitational force is acting on the luggage.
- (3) Gravitational force acting on the luggage decreases from A to B.
- (4) Friction acting on the luggage is less than the weight of the luggage.

(Go to Booklet B)



**Rosyth School
Preliminary Examination 2024**

**SCIENCE
Primary 6**

Name: _____

Total
Marks:

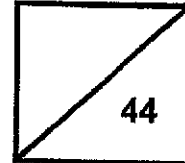

Class: Pr 6 _____

Register No. _____

Date: 22 August 2024

Parent's Signature: _____

Duration: Total time for Booklets A and B: 1 h 45 min

Booklet B

Instructions to Pupils:

1. Please do not turn this page until you are told to do so.
2. Follow all instructions carefully.
3. Answer all questions.
4. Use a dark blue or black ballpoint pen to write your answers in the space provided for each question.
5. Do not use correction fluid/tape or highlighters.

	Maximum	Marks Obtained
Booklet A	56 marks	
Booklet B	44 marks	
Total	100 marks	

* This booklet consists of 19 printed pages (including this cover page).

For questions 29 to 40, write your answers in the space provided. **(44 Marks)**

- 29 A farmer removed the bark around a branch of a fruit tree and wrapped wet moss around the branch and covered it with a plastic cover as shown below.

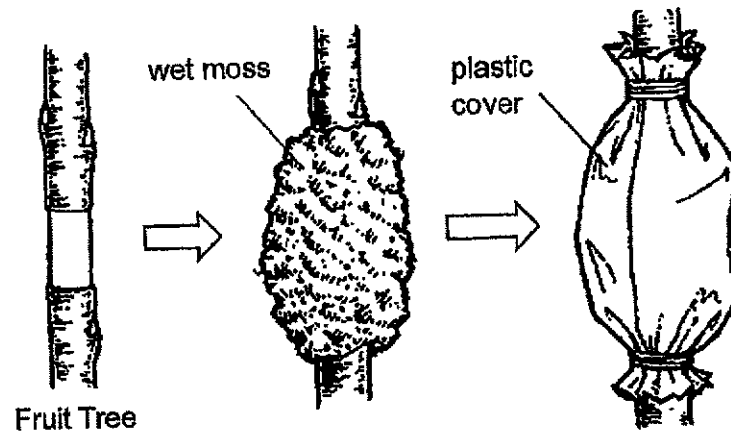

Months later, he removed the plastic cover and observed that Part X has developed around the wet moss.

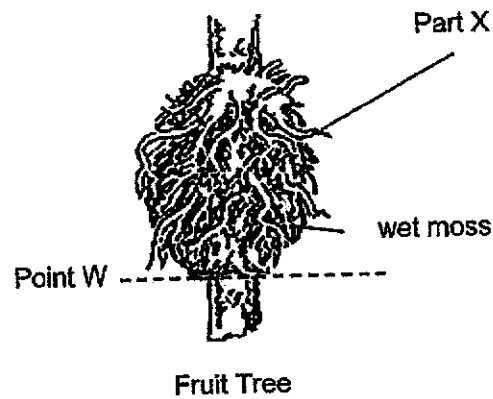

- (a) Part X has absorbed water from the wet moss for the survival of the Fruit Tree. What is Part X? [1]

Question 29 continues on page 3

The branch is cut off at Point W and planted as shown in the diagram below.

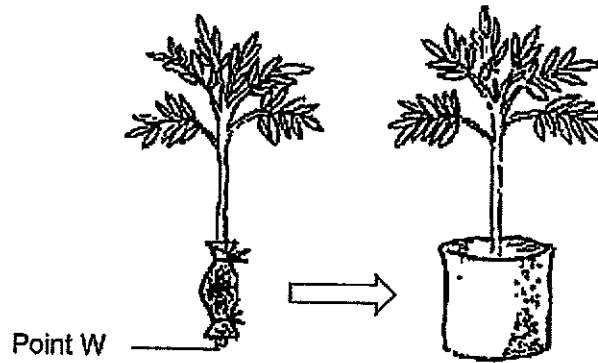

(b) What advantage does this method have compared to growing the fruit tree from a seed? [1]

30 Describe how oxygen in the environment reaches the human heart. [2]

- 31 Susan conducted an experiment using balls and a furry cloth. Each ball had a different number of plastic hooks.

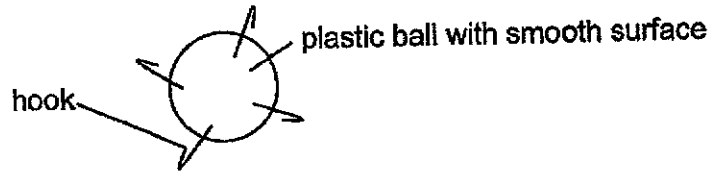

She stuck all three balls on a piece of furry cloth and walked in a straight line. The balls dropped at different distances from the starting point as shown below.

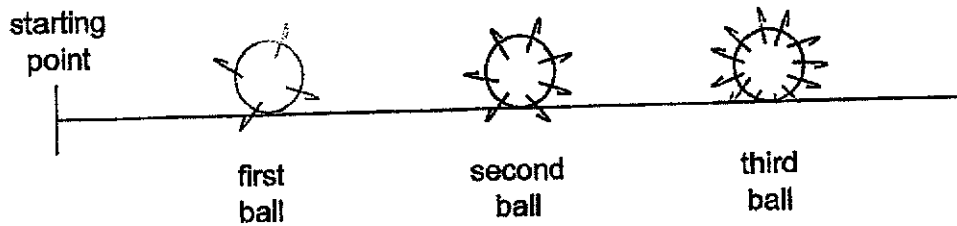

She recorded the number of hooks on each ball and the distance the ball had travelled just before dropping in the table below.

Number of hooks on each ball	Distance the ball travelled before dropping (cm)
4	30
7	90
12	140

- (a) Why is it important to use the same type of ball for the experiment? [1]

- (b) How can she improve the reliability of the results? [1]

Question 31 continues on page 5

The map below shows how the fruits of Plant A and Plant B are dispersed.

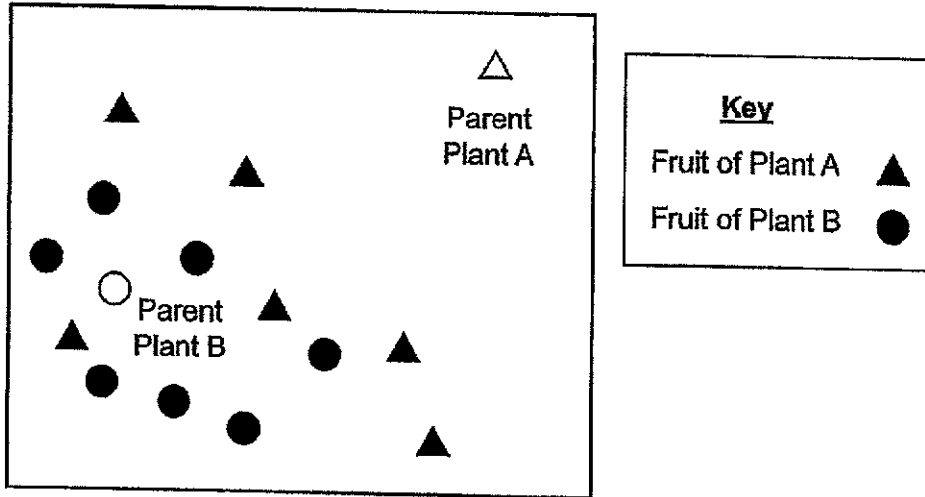

The fruits, H and J, are shown below. Both fruits have hooks on them.

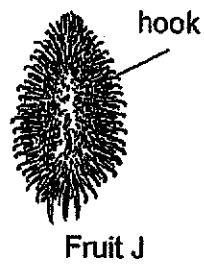
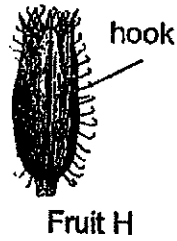

- (c) Using Susan's findings and the dispersal pattern, which fruit, H or J, represents the fruit of Plant A. Explain why. [2]

- 32 Leaves have tiny openings called stomata on their surfaces that are involved in gaseous exchange.

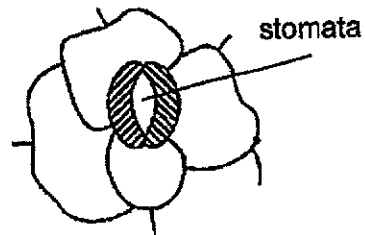

- (a) List two gases that are involved in gaseous exchange through the stomata. [1]
-

Halim measured the changes in the size of the stomata of a plant placed by the window at different times of the day, and the amount of light present.

The graphs below show his results.

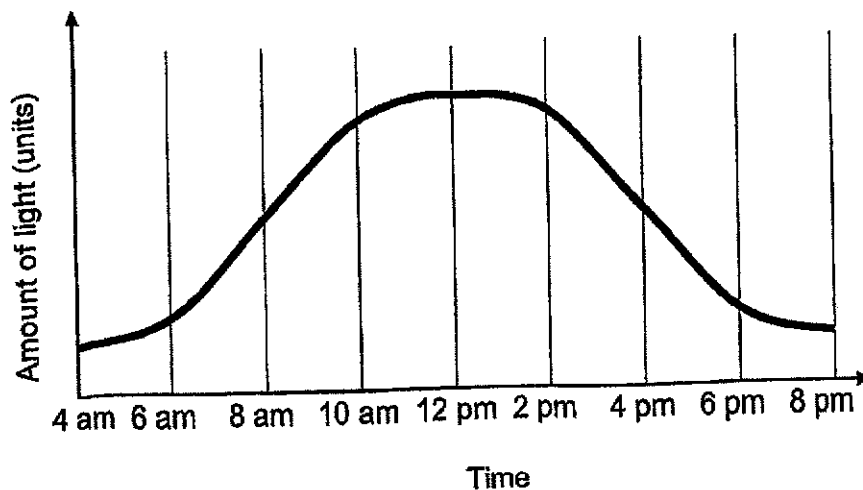
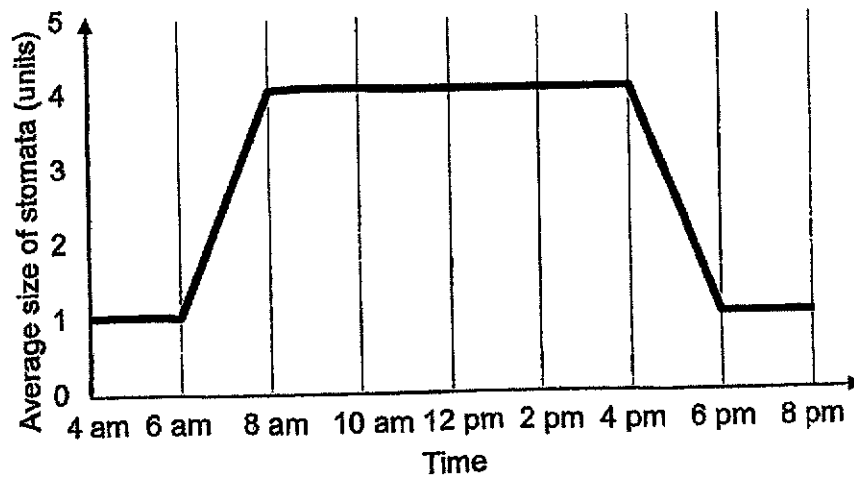

Question 32 continues on page 7

(b) Based on his results, how did the amount of light affect the size of the stomata from 8 am to 10 am? [1]

(c) Suggest a reason for your answer in (b). [1]

(d) Plants growing in deserts open their stomata at night and close their stomata in the day.

Explain how the above adaptation is an advantage and a disadvantage for its survival. [2]

i) An advantage:

ii) A disadvantage:

- 33 Certain cardboards have wave-like structures called flutes as shown below.

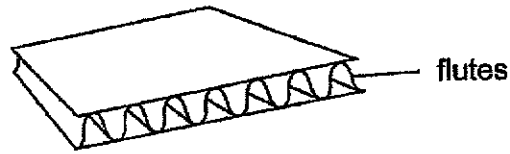

The diagram below shows how the number of flutes is counted.

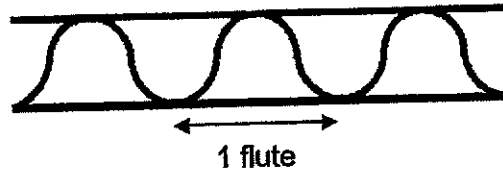

An experiment was conducted on different pieces of cardboard, of the same size, by increasing the load on them until the cardboard was crushed. The results are recorded in the table below.

Number of flutes	Mass of load before the cardboard was crushed (kg)
128	56
94	50
50	42
42	36
36	27

- (a) What is the property tested in the above experiment?

[1]

Question 33 continues on page 9

The picture below shows two types of Molluscs, A and B. They have shells with ridges to protect their soft body from predators.

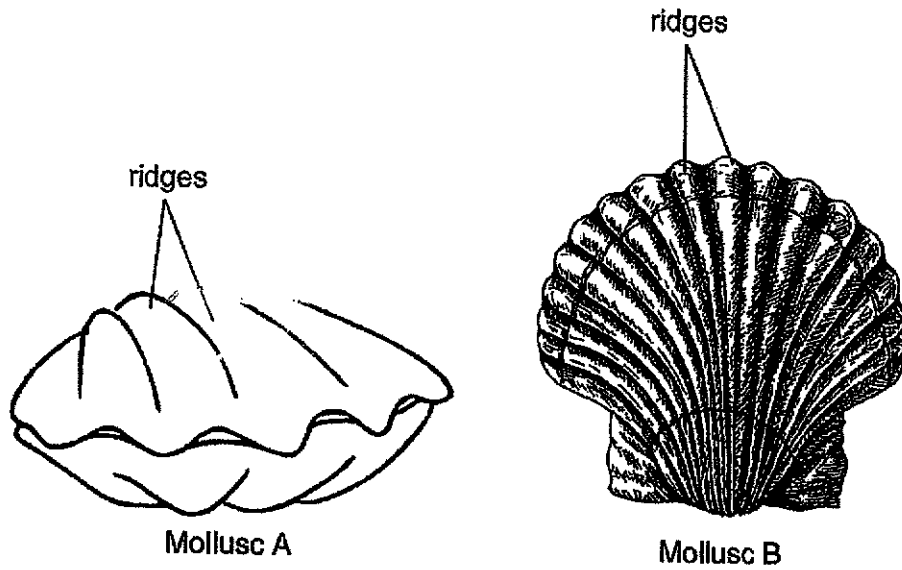

(b) Use the findings of the experiment to explain why more of Mollusc A is eaten than B by the same predators. [2]

- 34 The graph below shows the findings of a researcher on the chance of birds colliding with the windows of a building.

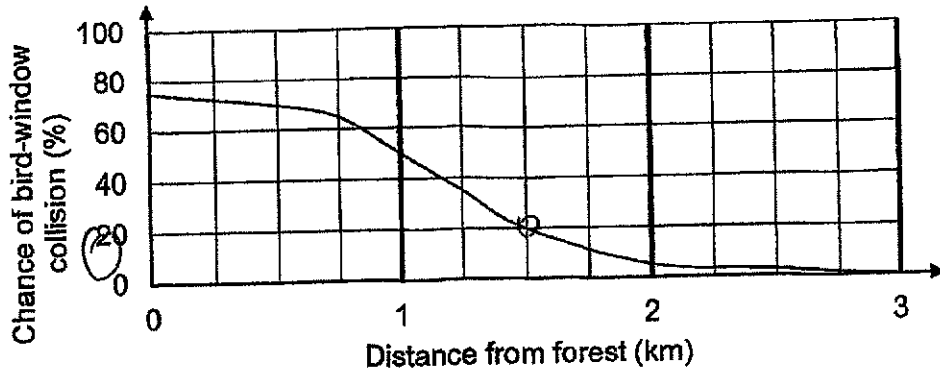

The map below shows buildings, A, B and C, and their distances from the forest.

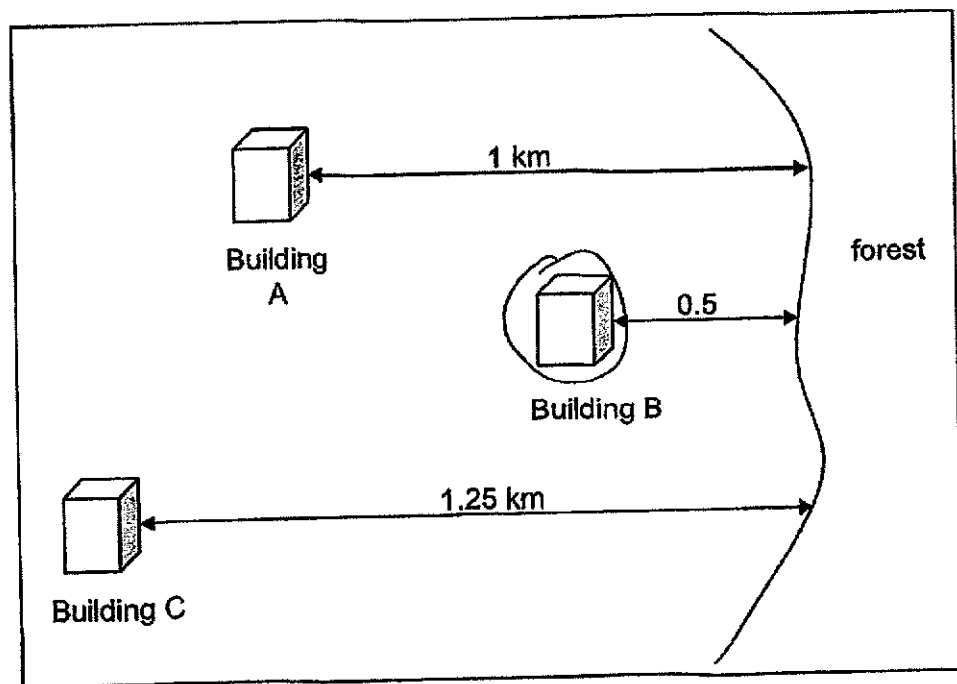

- (a) Circle the building on the map with the highest chance of bird collisions. [1]
- (b) Based on the graph, Building D was found to have a 20% chance of bird-window collisions.
 What was the distance of Building D from the forest? [1]

Question 34 continues on page 11

(c) The researcher has a hypothesis to test.
"Other than the distance from the forest, the height of the buildings also increases the chances of bird-window collisions."

Identify the three types of variables for the next experiment. [1]

Changed variable: _____

Measured variable: _____

Key variable to be kept the same: _____

The researcher also discovered that Bird P had an increased number of window collisions when more blue light was present.

The graph below shows the amount of blue light emitted by two types of streetlamps.

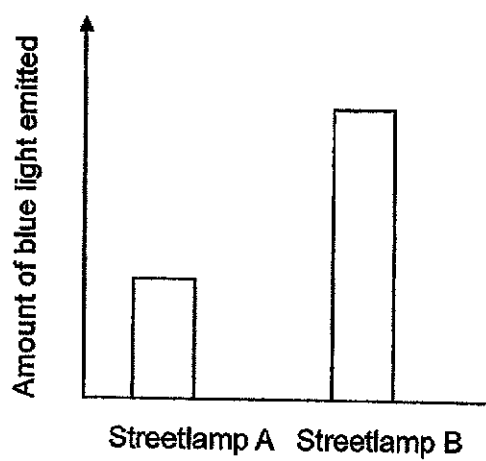

(d) Singapore is replacing streetlamp A with streetlamp B as B is more energy efficient.

Using the information, explain why the population of Bird P decreased rapidly in Singapore. [2]

35 The picture below shows an outdoor umbrella and a bed.

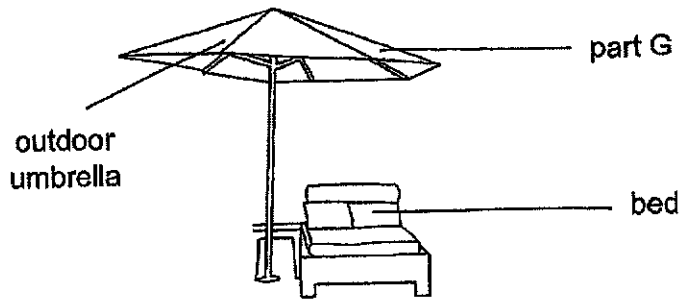

(a) State two properties of the material of part G so that it can provide protection from the sun. [2]

Property 1: _____

Property 2: _____

(b) An experimental set-up was used to compare four materials, W, X, Y and Z. For each material, the starting mass was measured. Then it was submerged in water for 24 hours. The material was then removed from the water and its mass was measured again. The increase in mass was calculated and recorded in the graph as shown below.

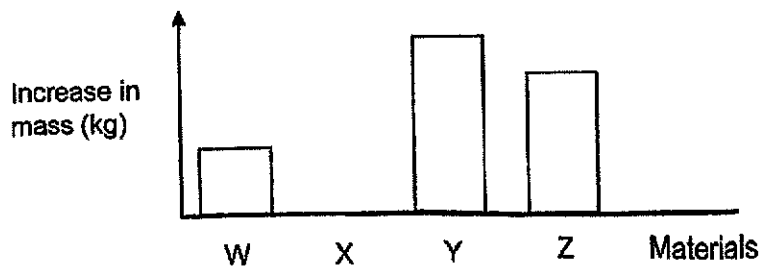

Fill in the two blanks.

Based on the results, material _____ is most suitable for part G because

it is _____ [1]

- 36 A device was designed as shown below to check whether a luggage bag weighs more than 30 kg. A luggage bag that weighs more than 30 kg will light up the bulb and make the bell ring.

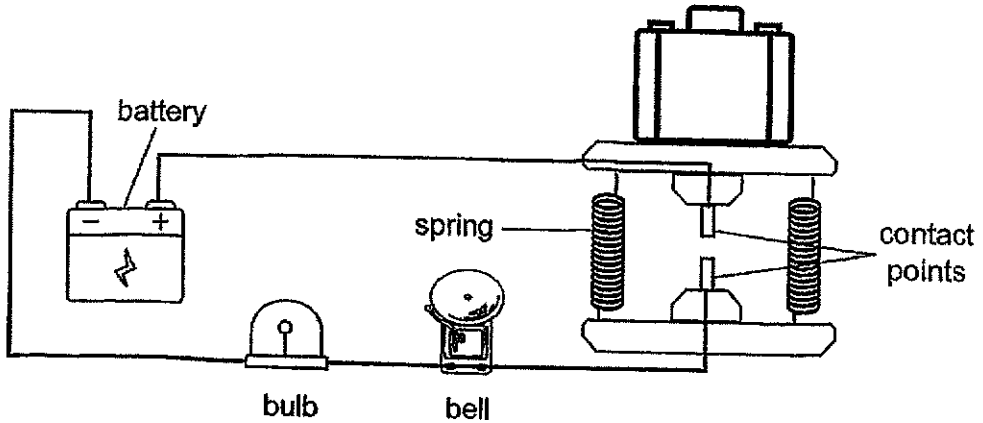

- (a) State a property of the two contact points that allows the device to work properly. [1]

- (b) State one advantage and one disadvantage for the device if the bulb and the bell were connected in parallel. [2]

Advantage:

Disadvantage:

- (c) After some time, when a 25 kg luggage was placed on the device, the bell rang and the bulb lighted up. Suggest a possible reason for this. [1]

- 37 Johnny took a bath in a tub of water. When he came out of the water, he felt cold.

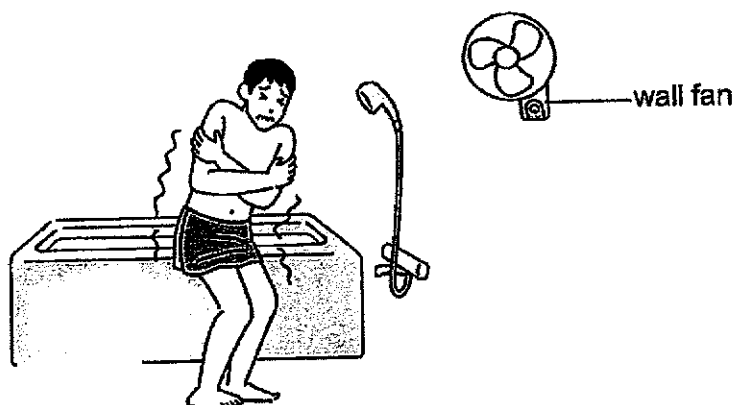

- (a) Explain why Johnny felt cold when he got out of the water. [2]

At that moment, the wall fan in the bathroom was switched on and he felt even colder.

- (b) Explain why he felt even colder when the wall fan was switched on. [1]

- 38 A bar magnet was fixed to the cart as shown in the diagram below. When the switch is closed, the cart moved along the track from point A to point B and then to point C.

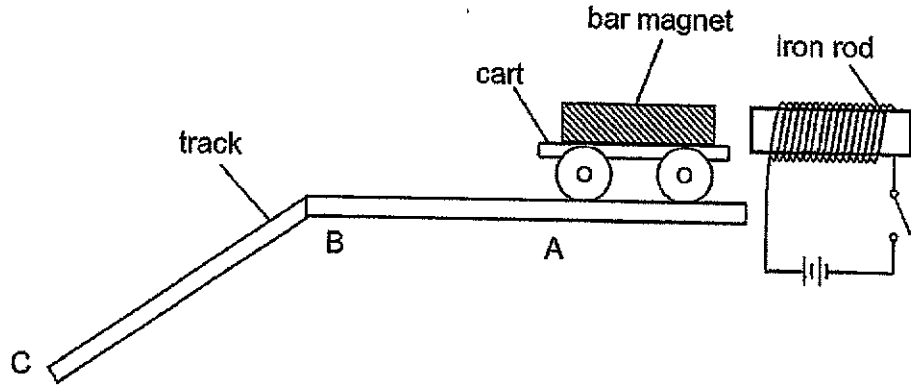

- (a) State an effect of a force when the switch is closed. [1]

- (b) Explain how the cart moved from point A to point B. [1]

- (c) The cart moved from B to C faster. Explain how. [1]

39 John constructed a toy as shown below.

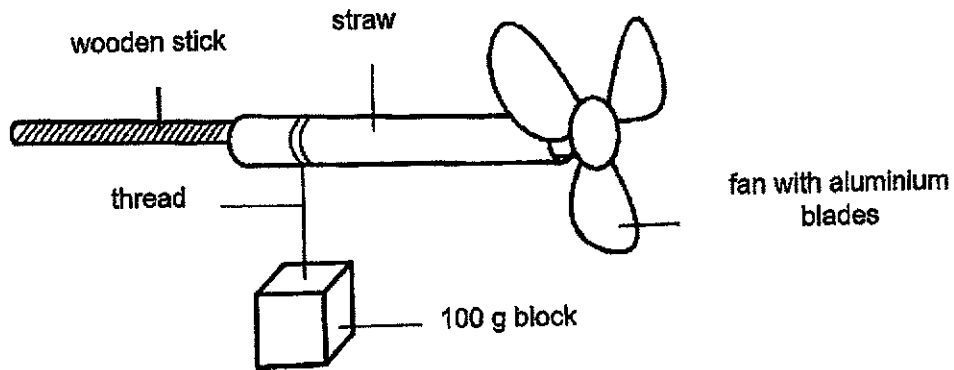

A thread attached to a 100 g block was wound around one end of the straw. When the block was allowed to drop, the fan spun freely. John then counted the number of turns the blades made in 20 seconds.

He repeated the experiment with blocks of different masses and blades made of different materials. He recorded the results in the table below.

Set-up	Mass of the block (g)	Material of blades	Number of turns made in 20 seconds
A	100	aluminium	20
B	200	aluminium	30
C	200	copper	25

(a) Fill in the boxes below to show the energy conversion when the block was allowed to drop. [2]

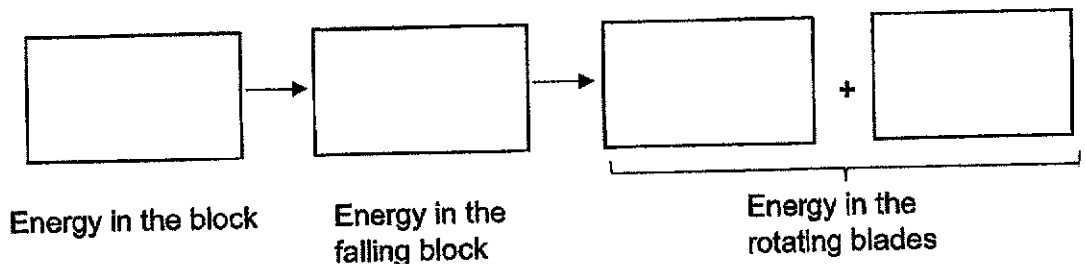

Question 39 continues on page 17

- (b) Based on the results shown above, using energy conversion, explain how the mass of the block affects the number of turns made in 20 seconds. [2]

- (c) Based on the results, can you conclude which material is better for the blades to spin faster? Explain how you arrived at your answer. [1]

- 40 An experiment was conducted using three kites, T, U and V of different sizes, as shown in the diagram below. They were made using similar paper material.

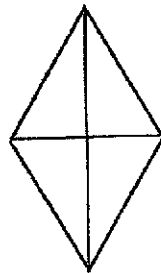

kite T

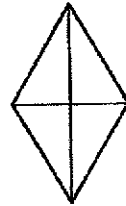

kite U



kite V

Each of the kite was dropped from the same height and the time taken for each kite to reach the ground was measured and recorded in the table below.

Kite	T	U	V
Time taken for kite to reach the ground (seconds)	13	?	3

- (a) What is the most likely result for kite U? [1]

- (b) Name two forces acting on all the kites as they fall to the ground. [1]

Question 40 continues on page 19

Study the features of the two animals, A and B shown below. They are of similar size.

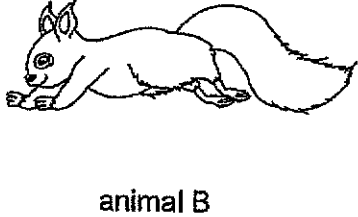
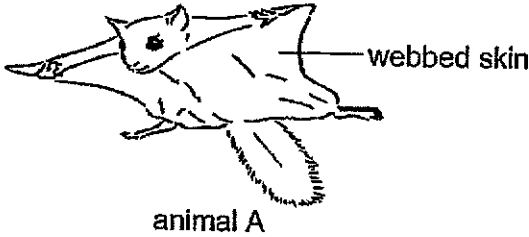

(c) Animals A and B jumped from the same height of a tree. Using the findings from the experiment, explain why animal A took a longer time to reach the ground. [1]

(d) Animal A is found in the rainforest. List two advantages of having the webbed skin when animal A moves from tree to tree. [2]

Advantage 1:

Advantage 2:

End of Paper

SCHOOL : ROSYTH PRIMARY SCHOOL
LEVEL : PRIMARY 6
SUBJECT : SCIENCE
TERM : 2024 PRELIM

Q 1	Q2	Q3	Q4	Q5	Q6	Q7	Q8	Q9	Q10
2	3	2	4	4	2	2	2	1	2
Q 11	Q12	Q13	Q14	Q15	Q16	Q17	Q18	Q19	Q20
1	3	4	4	3	1	1	1	2	4
Q 21	Q22	Q23	Q24	Q25	Q26	Q27	Q28		
1	3	1	4	3	3	4	4		

Rosyth School
Science Preliminary Examination 2024
Answers for Booklet B

Name: _____

Class: 6 _____

29a	Roots								
29b	Time taken for the plant to grow into an <u>adult</u> is <u>shorter</u> .								
30	The surrounding <u>air</u> enters the <u>nose</u> . The air goes to the <u>lungs</u> . In the lungs, <u>oxygen</u> is absorbed into the <u>bloodstream</u> . <u>oxygen-rich</u> blood is transported to the <u>heart</u> .								
31a	To ensure that the distance travelled by the ball is not affected by <u>smoothness of the ball surface of the ball</u> / <u>mass of the ball</u>								
31b	Repeat the experiment <u>a few</u> more times and calculate the <u>average</u> .								
31c	<div style="display: flex; justify-content: space-between;"> <div style="width: 60%;"> <p>Using the findings:</p> <p>The <u>more</u> hooks the fruit has, the <u>greater</u> the distance travelled.</p> <p>Elaborate on the dispersal pattern:</p> <p>The fruits of plant A are dispersed <u>further</u> from the parent plant, so it should have <u>more</u> hooks to cling on the animal before dropping.</p> </div> <div style="width: 35%;"> <table border="1" style="width: 100%; text-align: center; border-collapse: collapse;"> <thead> <tr> <th style="padding: 2px;">Number of hooks on each ball</th> <th style="padding: 2px;">Distance the ball travelled before dropping (cm)</th> </tr> </thead> <tbody> <tr> <td style="padding: 2px;">4</td> <td style="padding: 2px;">30</td> </tr> <tr> <td style="padding: 2px;">7</td> <td style="padding: 2px;">80</td> </tr> <tr> <td style="padding: 2px;">12</td> <td style="padding: 2px;">140</td> </tr> </tbody> </table> <div style="text-align: center; margin-top: 10px;"> </div> </div> </div>	Number of hooks on each ball	Distance the ball travelled before dropping (cm)	4	30	7	80	12	140
Number of hooks on each ball	Distance the ball travelled before dropping (cm)								
4	30								
7	80								
12	140								
32a	<u>oxygen</u> and <u>carbom dioxide</u>								
32b	As the amount of light <u>increased</u> from 8am-10am, the size of the stomata <u>did not change</u> .								
32c	The stomata had opened <u>completely</u> .								

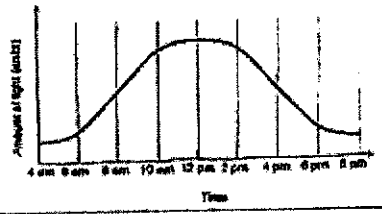
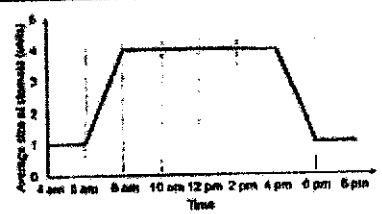

32di	Advantage: To reduce <u>water loss</u> so that the plant can survive with little water.	
32dii	Disadvantage: Less <u>carbon dioxide</u> is taken in so rate of photosynthesis <u>decreases</u> .	
33a	<u>Strength</u>	
33b	<p>Use the findings of the experiment: Mollusc A has <u>less</u> ridges than Mollusc B. So A has <u>a weaker shell</u> than B.</p> <p>Explanation: Predators use <u>less</u> force to break the shell of A to eat it.</p>	
34a	Highest chance of bird collision: <u>Building B</u>	
34b	Distance of building B from the forest: <u>1.5 km</u>	
34c	<p>Hypothesis: Other than the distance from the forest, the height of the building also increases the chances of bird-window collisions.</p> <p>Changed variable: <u>Height of building</u></p> <p>Measure variable: <u>chances of bird window collisions</u></p> <p>KEY variable to be kept the same: <u>distance from the forest</u></p>	
34d	<p>Using the information: Streetlamp B emits <u>more blue light</u> than streetlamp A, so more birds will collide with the window and die. There is higher death rate than <u>birth</u> rate.</p>	
35a	Property 1: <u>Poor conductor of heat</u> Property 2: <u>Opaque</u>	

35b	<p>Based on the results, material <u>X</u> is most suitable for part G because it is <u>waterproof</u>.</p>	<table border="1"> <caption>Increase in mass (%)</caption> <thead> <tr> <th>Material</th> <th>Increase in mass (%)</th> </tr> </thead> <tbody> <tr> <td>W</td> <td>~10</td> </tr> <tr> <td>X</td> <td>~5</td> </tr> <tr> <td>Y</td> <td>~35</td> </tr> <tr> <td>Z</td> <td>~25</td> </tr> </tbody> </table>	Material	Increase in mass (%)	W	~10	X	~5	Y	~35	Z	~25
Material	Increase in mass (%)											
W	~10											
X	~5											
Y	~35											
Z	~25											
36a	<p><u>conductors</u> of electricity</p>											
36b	<p>Advantage of parallel arrangement: If the bulb <u>fused</u>, the bell can still work and if the bell is <u>spoilt</u>, the bulb can still light up.</p> <p>Disadvantage of parallel arrangement: The battery will <u>run out faster</u>.</p>											
36c	<p>The springs <u>are less stiff</u>.</p>											
37a	<p>The water on Johnny's body <u>gain heat from his body</u> and <u>evaporated to become water vapour</u>. When Johnny's body lost heat, he felt cold.</p>											
37b	<p>Factor that affects rate of evaporation:</p> <p>The <u>wind</u> from the fan <u>increased</u> the rate of evaporation.</p>											
38a	<p>Effect of a force:</p> <p>Make a <u>stationary</u> object <u>move</u>.</p>											
38b	<p>When the circuit is closed, the iron rod becomes an <u>electromagnet</u>. The electromagnet <u>repelled</u> the bar magnet and pushed the cart from A to B.</p>											
38c	<p>Answer in terms of forces: <u>gravitational</u> force was pulling the cart <u>down</u>.</p> <p>Answer in terms of energy: As the cart moves down the slope, <u>potential</u> energy is converted to <u>kinetic</u> energy.</p>											

39a	<pre> graph LR A[Potential energy] --> B[Kinetic energy] B --> C[Kinetic energy] B --> D[sound energy] C --- E[energy in the rotating blades] style E stroke-width:0px </pre> <p>Potential energy → Kinetic energy → Kinetic energy + sound energy</p> <p>Energy in the block Energy in the falling block energy in the rotating blades</p>
39b	<p>Answer in terms of energy conversion:</p> <p>As the _____ mass of the block increase _____, potential energy of the block _____ increases _____.</p> <p>More _____ potential energy _____ is converted to more _____ kinetic energy _____ resulting in more number of turns in 20 seconds.</p>
39c	<p>Answer must take reference from the experimental results:</p> <p>Yes</p> <p>Set-up B and C have the same _____ mass off lead _____, but the _____ aluminium _____ blade turned faster than the _____ copper _____ blade in 20 seconds.</p>
40a	<p>Most likely results for kite U:</p> <p>Any number from 4-12</p>
40b	<p>Two forces acting on the kites before they fall to the ground:</p> <ol style="list-style-type: none"> 1. _____ Gravity _____ 2. _____ Friction _____
40c	<p>Using the findings from the experiment:</p> <p>Animal A has _____ a large area of webbed skin which increases the surface area in contact _____ with the air, slowing it down from dropping from the same height.</p>
40d	<p>Advantage 1:</p> <p>It can _____ jump _____ further from tree to tree to _____ escape predators _____.</p> <p>Advantage 2:</p> <p>It can _____ fall slowly from a height without getting injured. _____.</p>

1000
1000
1000