



**NAN HUA PRIMARY SCHOOL**  
**TERM 2 NON-WEIGHTED ASSESSMENT 2024**  
**PRIMARY 6**  
**SCIENCE**  
**BOOKLET A**

**28 Multiple Choice Questions (56 marks)**

**Total Time for Booklets A and B: 1 hour 45 minutes**

**INSTRUCTIONS TO CANDIDATES**

1. Write your name, index number and class in the spaces provided below.
2. Do not turn over the page until you are told to do so.
3. Follow all instructions carefully.
4. Answer all questions.
5. Use a 2B pencil to shade your answers on the Optical Answer Sheet (OAS).

**Marks Obtained**

Booklet A		/ 56
Booklet B		/ 44
Total		/ 100

Name: \_\_\_\_\_ (     )

Form Class P6 \_\_\_\_\_

Teaching Group 6S \_\_\_\_\_

Date: 3<sup>rd</sup> May 2024

Parent's Signature: \_\_\_\_\_

---

This booklet consists of 20 printed pages.

**Section A: (28 x 2 marks = 56 marks)**

For each question from 1 to 28, four options are given. One of them is the correct answer. Make your choice (1, 2, 3 or 4) and shade your answer on the Optical Answer Sheet.

- 1 Study the diagrams carefully.

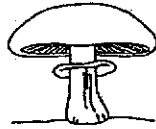

living thing A



living thing B

Which of the following about living things A and B is correct?

	Living thing A	Living thing B
(1)	It reproduces by spores.	It reproduces by seeds.
(2)	It needs air, food and water to survive.	It only needs air and water to survive.
(3)	It is a plant that cannot bear flowers.	It is a plant that can bear flowers.
(4)	It cannot make its own food. It feeds on living or dead matter it grows on.	It can make only its own food using sunlight but not other light sources.

- 2 The diagrams show the different stages of development of a flowering plant.

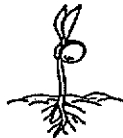

A



B



C

Which of the following shows the correct order of development of the plant?

- (1) A → B → C  
 (2) B → A → C  
 (3) C → A → B  
 (4) C → B → A

- 3 A toy bear was left untouched inside a box. Which of the following graphs shows how the mass of the toy bear most likely changed over time?

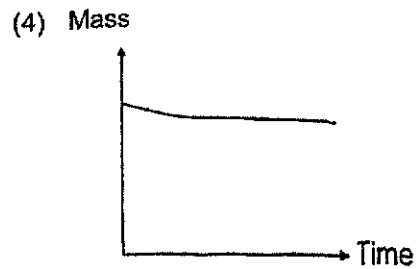
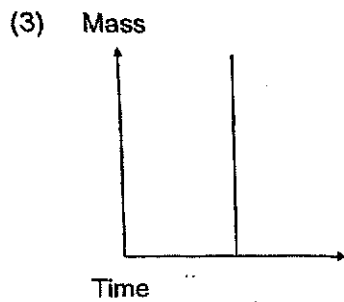
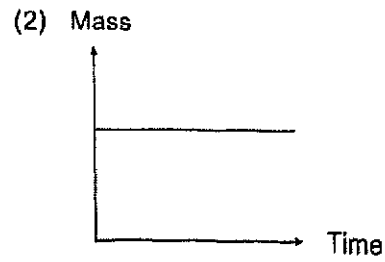
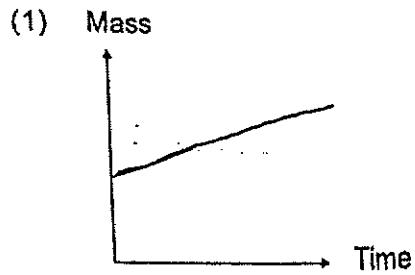

- 4 The diagram shows a plant cell.

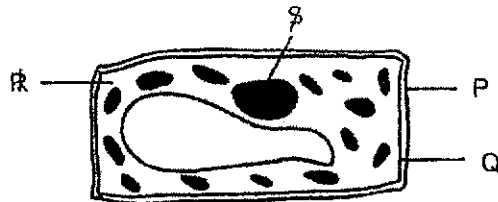

Which of the following parts and functions of the cells are correctly matched?

- P It provides a regular shape to the cell.  
 Q It allows substances to move in and out of the cell.  
 R It controls all cell activities taking place in the cell.  
 S It is the place where cell activities take place.

- (1) Q and R only  
 (2) P, Q and S only  
 (3) P, R and S only  
 (4) P, Q, R, S

5 The diagram shows a human reproduction process.

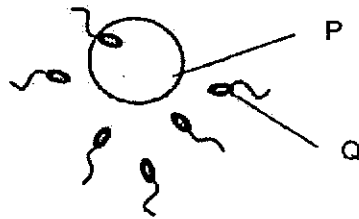

What are cells P and Q and the parts where these cells are produced from?

	Cell P	Part producing cell P	Cell Q	Part producing cell Q
(1)	egg	ovary	sperm	penis
(2)	egg	ovary	sperm	testis
(3)	sperm	testis	egg	ovary
(4)	sperm	testis	egg	ovule

6 Ashley conducted an experiment with a flower on a plant.

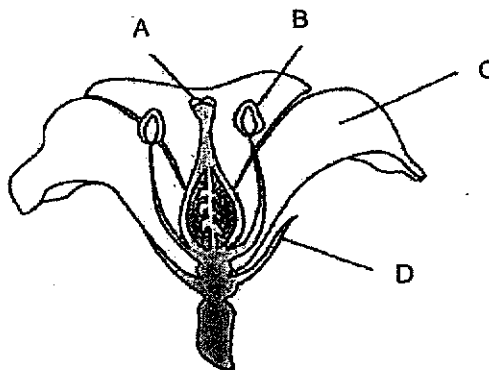

She removed one part of the flower. The flower did not produce any seeds after that. Which part of the flower, A, B, C or D, did Ashley remove?

- (1) A
- (2) B
- (3) C
- (4) D

7 The diagram shows the human body system.

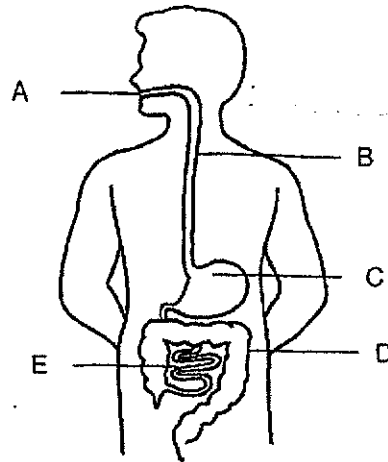

Which parts of the digestive system produce digestive juices?

- (1) B and E only
- (2) A, C and D only
- (3) A, C and E only
- (4) C, D and E only

8 Study the diagram.

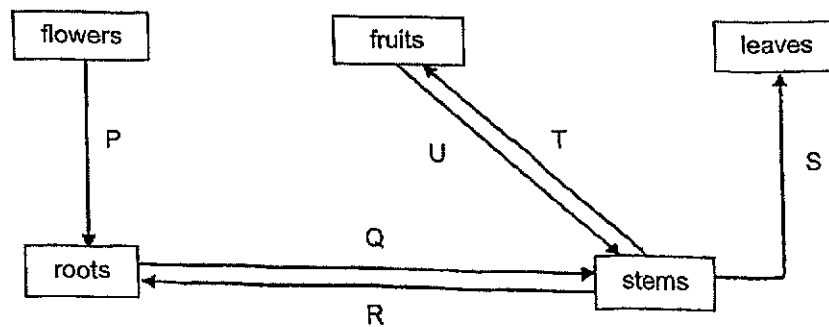

Which arrows show the correct direction in which water moves in a plant?

- (1) P, Q and U only
- (2) Q, S and U only
- (3) Q, S and T only
- (4) P, Q, S and T only

- 9 Isabella plucked a leaf from a plant and placed it in a beaker of hot water.

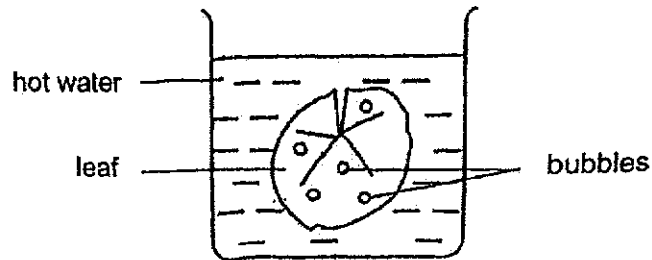

She observed that bubbles are formed only on the upper surface of the leaf. Which of the following conclusions is correct?

- (1) Air escaped through openings found on both surfaces of the leaf.
  - (2) Air escaped through openings found only on the upper surface of the leaf.
  - (3) Air entered the openings through the upper surface of the leaf and was trapped.
  - (4) Air entered the lower surface of the leaf and escaped through the upper surface.
- 10 Ruben set up his stall on a field as shown. After one month, he noticed that the grass patch below the stall turned yellow.

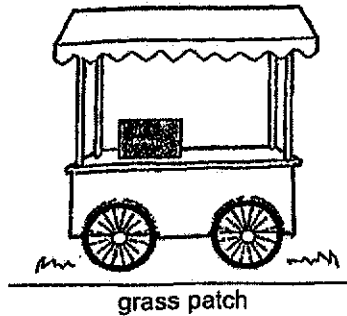

Which of the following best explains why the grass patch turned yellow?

- (1) The wheels of the stall rolled over the grass and killed the grass.
- (2) There is not enough sunlight for the grass to make food as light is blocked.
- (3) There is not enough carbon dioxide for the grass to make food as carbon dioxide cannot reach the grass.
- (4) There is not enough water for the leaves to make food as the wheels of the stall damaged the water-carrying tubes.

11 The diagram shows the direction of blood flow in some parts of the body.

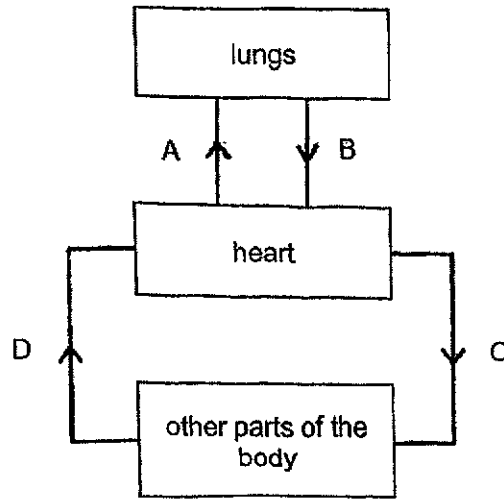

The same amount of blood was taken from parts A, B, C and D. Which bar graph shows the correct comparison of the amount of carbon dioxide in the blood samples?

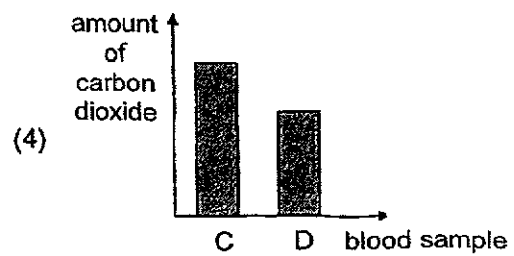
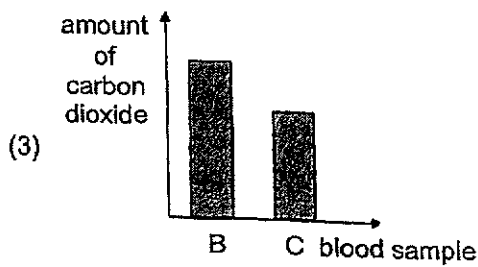
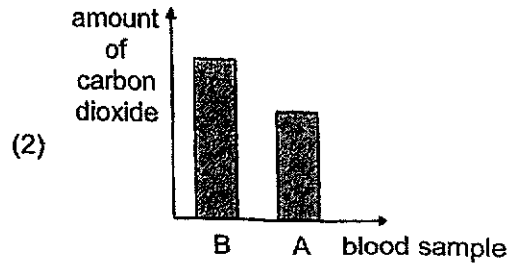
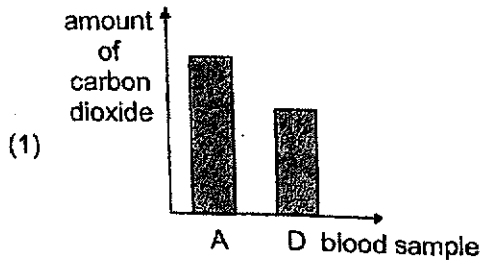

- 12 The graph shows the amount of rain in country S every year.

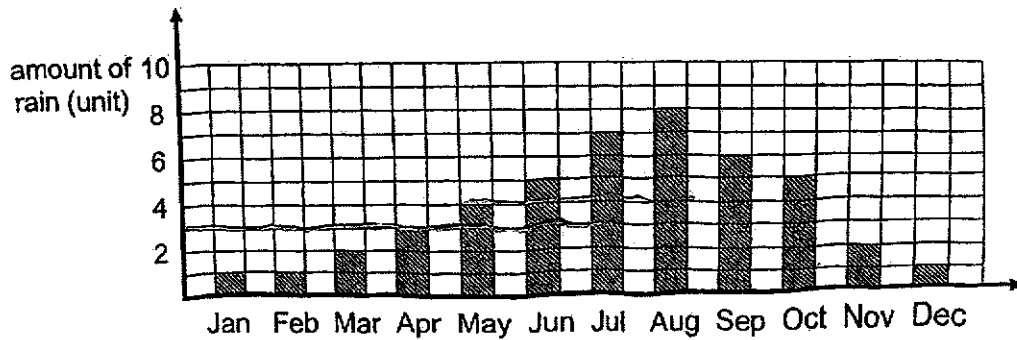

The table shows some information about the growth of plants A and B.

	Plant A	Plant B
Time to become adult plants (months)	3	4
Amount of rain suitable for growth (unit)	3 or more	4 or less

Which plant(s) can grow in country S?

- (1) plant A
  - (2) plant B
  - (3) both plants A and B
  - (4) neither plant A nor B
- 13 The food relationship between three organisms is shown.

$$X \rightarrow Y \rightarrow Z$$

The following took place when entire population of X is wiped out due to a disease.

- A There was no food for Y.
- B The number of Y decreased.
- C The number of Z decreased.
- D There was insufficient food for Z.

Which of the following shows the correct sequence of events?

- (1) A, B, C, D
- (2) A, B, D, C
- (3) B, A, C, D
- (4) B, A, D, C



- 14 A tree supports only the organisms shown.

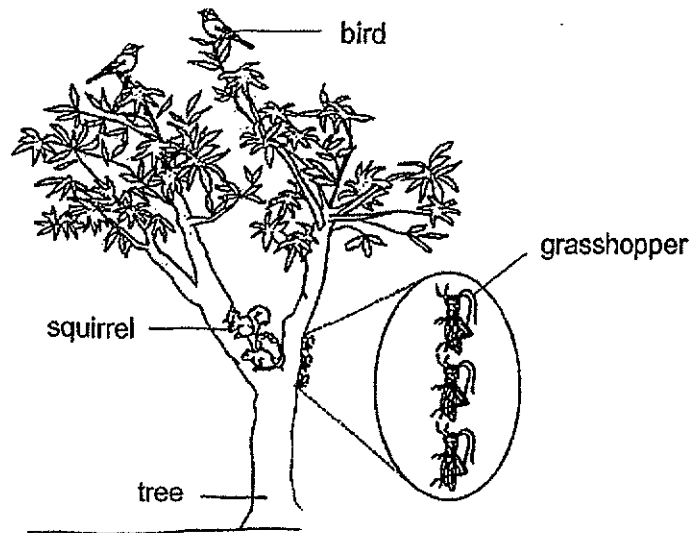

Which of the following is correct?

- (1) The birds are visitors to this habitat.
- (2) The squirrels form two communities.
- (3) The population size of grasshopper is three.
- (4) The birds and the tree form one community.

15 Study the flowchart below.

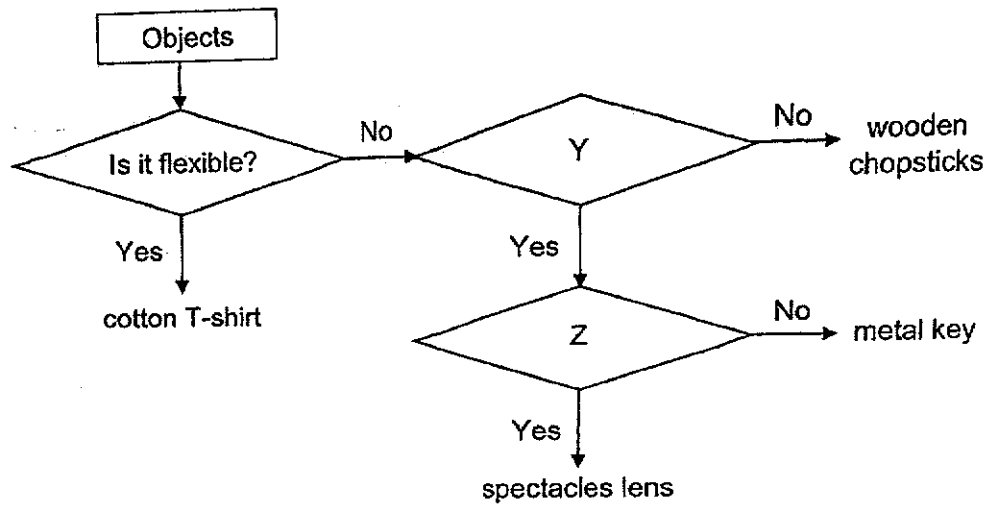

Which of the following headings for Y and Z are correct?

	Y	Z
(1)	Is it strong?	Does it float on water?
(2)	Does it float on water?	Is it strong?
(3)	Is it waterproof?	Does it allow light to pass through?
(4)	Does it allow light to pass through?	Is it waterproof?

- 16 Study the flow chart which classifies objects A, B and C below.

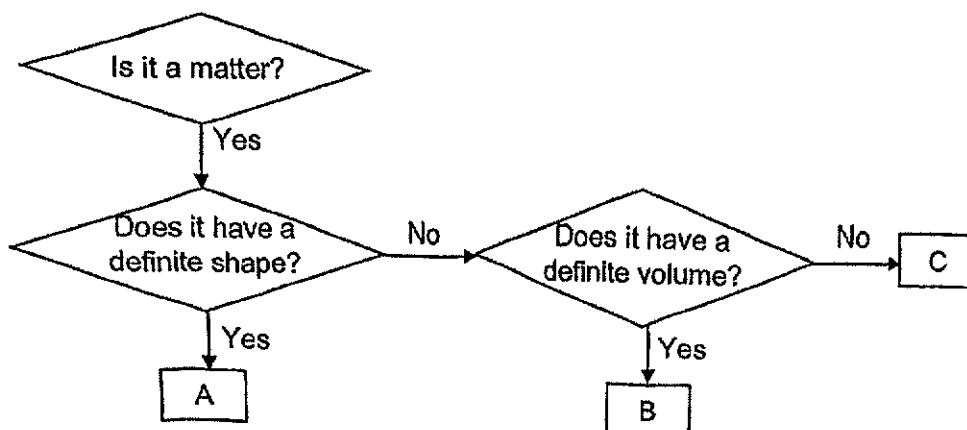

The table below shows the characteristics of objects X and Y. A tick (✓) represents the characteristic an object possess.

Characteristic	Object	
	X	Y
Occupies space	✓	✓
Can be compressed		✓
Takes the shape of the container it is in		✓

Based on the flow chart and the table above, which objects, A, B or C has similar characteristics as objects X and Y?

	Object X	Object Y
(1)	A	C
(2)	B	C
(3)	C	B
(4)	A	B

- 17 Katie poured some hot water into a beaker. After five minutes, she observed some water droplets forming on the inner sides of the beaker and at the top of the plastic lid, as shown below.

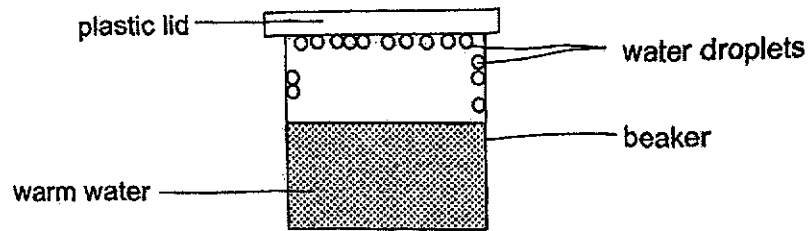

Which of the following processes resulted in the formation of the water droplets as shown in the diagram above?

- A Boiling
- B Melting
- C Evaporation
- D Condensation

- (1) A and B
- (2) A and C
- (3) B and C
- (4) C and D

- 18 The table below shows the melting and boiling points of three substances, P, Q and R.

substance	melting point (°C)	boiling point (°C)
P	10	100
Q	59	66
R	60	150

At which temperature are all three substances in the liquid state?

- (1) 0 °C
- (2) 30 °C
- (3) 65 °C
- (4) 170 °C

- 19 Ismail constructed an electric circuit consisting of a bulb joined by wires to a battery and an unknown object W. The bulb lit up when the circuit was closed.

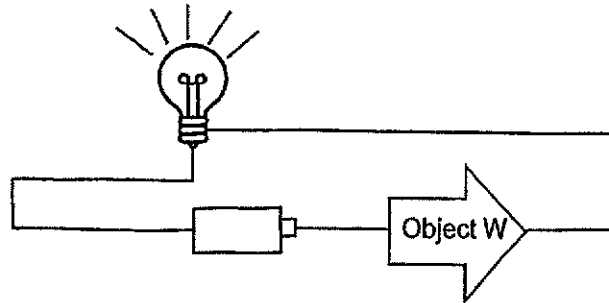

When he changed the position of the unknown object as shown below, the bulb did not light up.

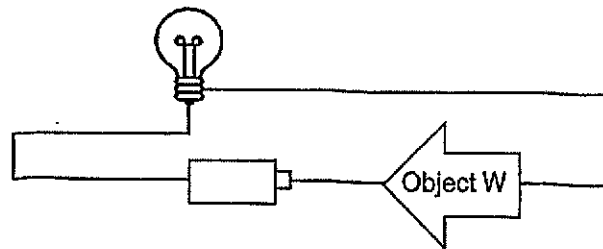

Which one of the following objects is most likely to be object W?

- (1) A bulb
- (2) A battery
- (3) A metal coin
- (4) A copper wire

- 20 John set up a light sensor in a dark room to count how many times he could run across the length of the room from wall A to wall C, back and forth, in one minute. He ran at the same speed throughout the experiment. The arrow indicated his direction of movement.

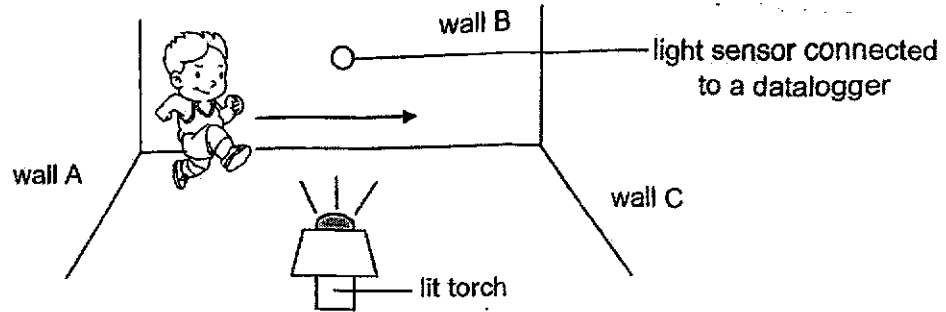

Which graph below shows that he had run 4 times across the room back and forth in one minute at the same speed?

(1)

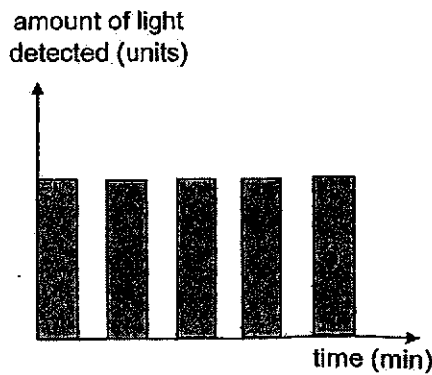

(2)

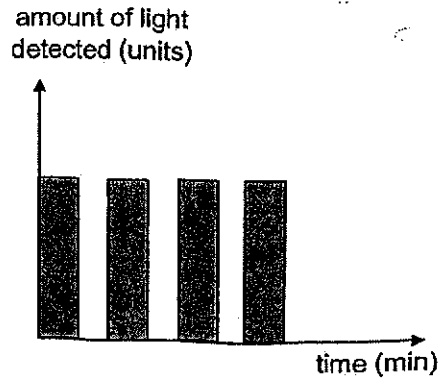

(3)

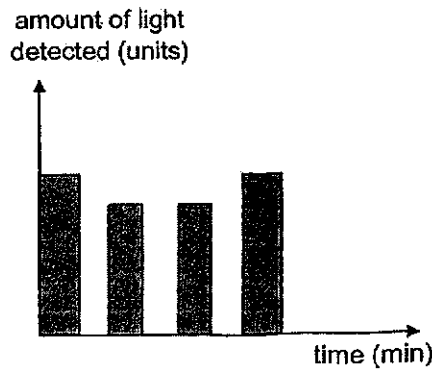

(4)

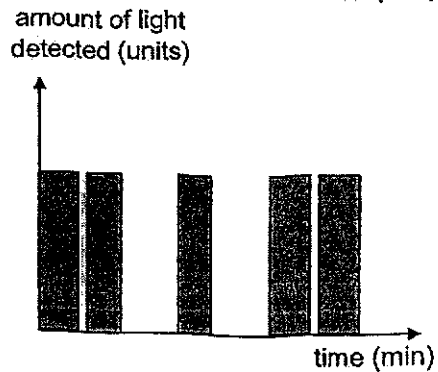

- 21 The diagram below shows Uncle Tarik pouring hot tea from one cup to another cup below a few times before serving his customers. This technique has a special name called "pulling tea".



How does his action of "pulling tea" help in cooling down the tea in the cup?

- (1) When the tea flows from one cup to another, it gains less heat from the surroundings.
- (2) When the tea flows from one cup to another, it gains more heat from the surroundings.
- (3) The tea has a smaller exposed surface area in contact with the air to lose heat slower when it is poured from a higher height to a lower height.
- (4) The tea has a greater exposed surface area in contact with the air to lose heat faster when it is poured from a higher height to a lower height.

- 22 The diagram below shows a bridge suspended, with one of its ends fixed while the other end attached to rollers.

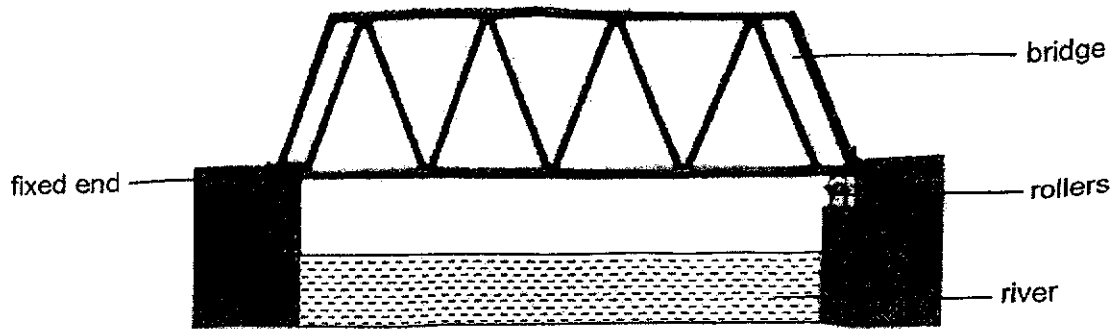

What is the purpose of the rollers on the bridge?

- (1) The rollers strengthen the bridge so that it can withstand heavier loads.
  - (2) The rollers allow bridge to expand and contract with temperature changes.
  - (3) The rollers allow heat generated on the bridge to be lost to the surrounding air faster.
  - (4) The rollers reduce friction between the cars and bridge so that the cars can travel faster.
- 23 Which of the following are sources of energy?
- A Sun
  - B Wind
  - C Batteries
  - D Running water
- (1) A and B only
  - (2) A and C only
  - (3) A, B and C only
  - (4) A, B, C and D



- 24 The diagram below shows the main parts of a hydroelectric power station. Stored water is used to turn a turbine to produce electricity. The arrows indicated the direction of moving water.

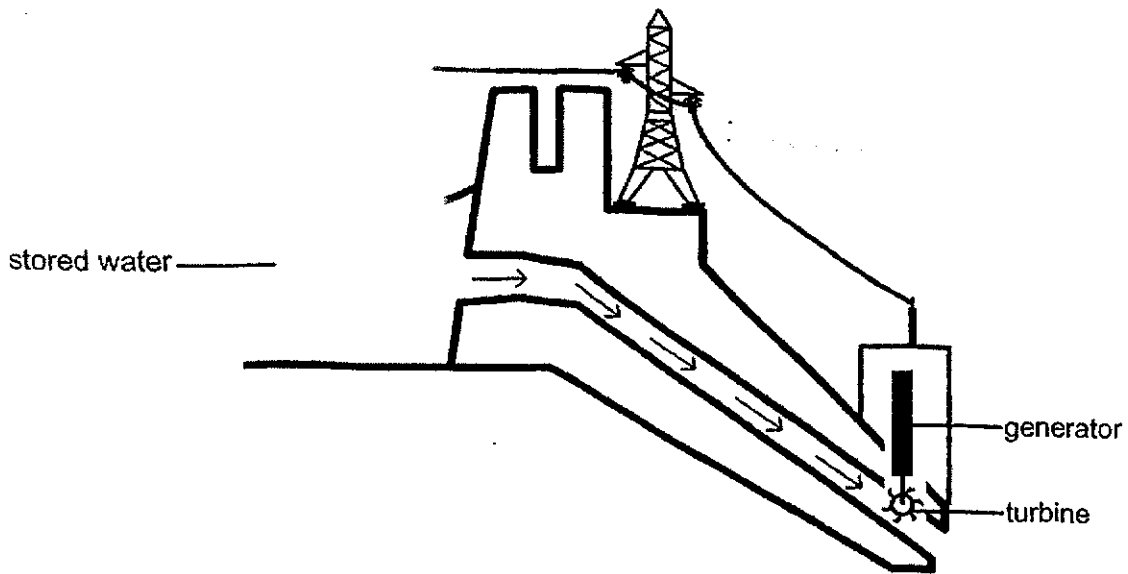

Which of the following correctly shows the energy changes in the hydroelectric power station?

- (1) electrical energy → kinetic energy → kinetic and heat energy  
 (stored water) (moving water) (turbine)
- (2) kinetic energy → heat energy → kinetic energy → electrical energy  
 (stored water) (turbine) (turbine) (generator)
- (3) potential energy → kinetic energy → kinetic energy → electrical energy  
 (stored water) (moving water) (turbine) (generator)
- (4) potential energy → kinetic energy → kinetic energy → electrical energy  
 (stored water) (turbine) (moving water) (generator)

- 25 When object W is placed near end A of object X, object W moves towards it.

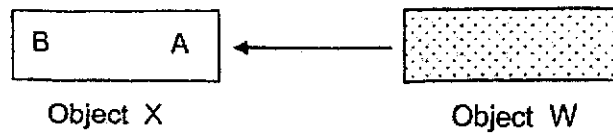

When object W is placed near end B of object X, both objects W and X move away from each other.



When object W is placed near object Y, object Y does not move at all.



Which of the following statements are true of objects W, X and Y?

- A Both W and Y are magnets.
  - B Object W could be made of steel.
  - C Both objects X and W are magnets.
  - D Object Y is made of a non-magnetic material.
- (1) A and B only  
 (2) C and D only  
 (3) A, B and C only  
 (4) B, C and D only

26 Which of the following statements about friction are true?

- A It produces heat when two surfaces are in motion.
- B It acts in the same direction of a moving object.
- C It can be reduced by using rollers and wheels.
- D It can help to slow down a moving object.

- (1) A and B only
- (2) C and D only
- (3) A, B and C only
- (4) A, C and D only

27 Jane wanted to find out which fabric is best for making a cleaning cloth for her microscope lens without scratching its surface. She constructed the set-up as shown below.

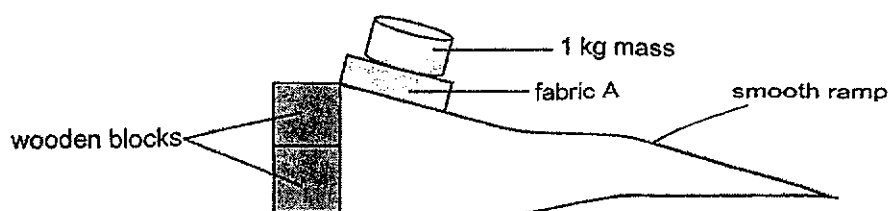

She increased the height of the adjustable ramp by adding wooden blocks until the fabric started to slide. She repeated the experiment with three fabrics, B, C and D. The results of her experiment is shown in the table below.

Fabric	Number of wooden blocks when fabric starts to slide
A	2
B	7
C	5
D	4

Based on the results, which of the following fabric should Jane choose to make the cleaning cloth?

- (1) A
- (2) B
- (3) C
- (4) D

- 28 Mandy carried out an experiment to find out if different masses of objects affect the extension of a spring. A line graph was plotted as shown below after the experiment.

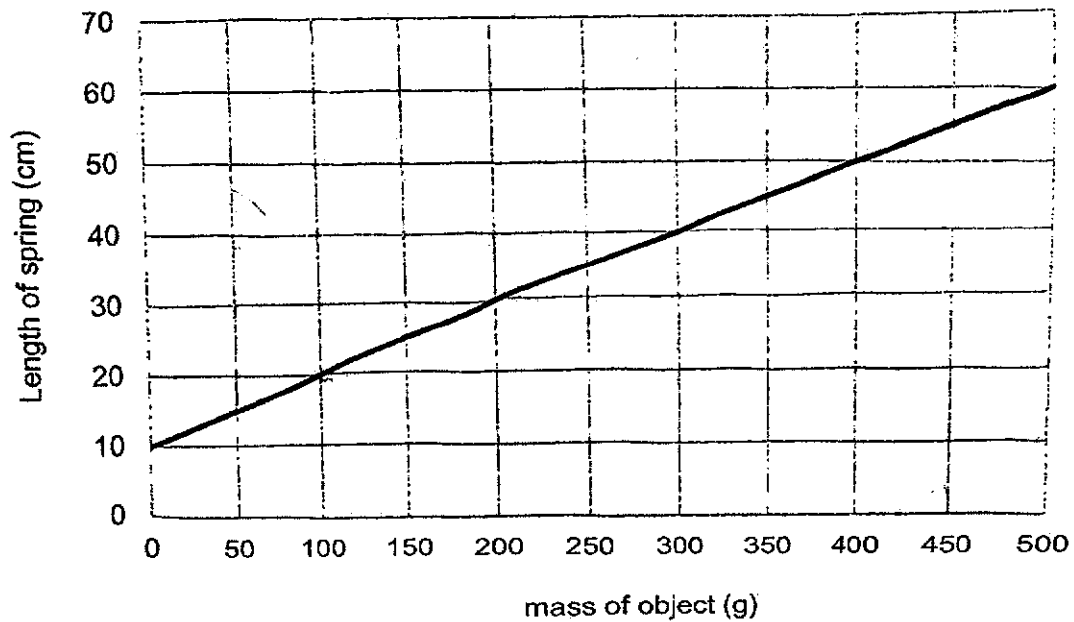

What can Mandy conclude from the line graph below?

- A Doubling the mass of object will double the length of the spring.
  - B The extension of the spring is 20cm when 200g object is hung on it.
  - C The extension of the spring is 50cm when 400g object is hung on it.
- (1) A only
  - (2) B only
  - (3) B and C only
  - (4) A, B and C

End of Booklet A



NAN HUA PRIMARY SCHOOL  
TERM 2 NON-WEIGHTED ASSESSMENT 2024  
PRIMARY 6  
SCIENCE  
BOOKLET B

12 Open-ended questions (44 marks)  
Total Time for Booklets A and B: 1 hour 45 minutes

**INSTRUCTIONS TO CANDIDATES**

1. Write your name, index number and class in the spaces provided below.
2. Do not turn over the page until you are told to do so.
3. Follow all instructions carefully.
4. Answer all questions.
5. Use a dark blue or black ballpoint pen to write your answers in the space provided for each question.
6. Do not use correction fluid/tape or highlighters.

Marks Obtained

Section B		/ 44
-----------	--	------

Name: \_\_\_\_\_ (      )

Class: P 6 \_\_\_\_\_ Teaching Group: 6S \_\_\_\_\_

Date: 3<sup>rd</sup> May 2024 Parent's Signature: \_\_\_\_\_

---

This booklet consists of 16 printed pages.

**Section B: (44 marks)**

For questions 29 to 40, write your answers in the spaces provided.

The number of marks available is shown in brackets [ ] at the end of each question or part question.

29 The diagram shows a plant cell.

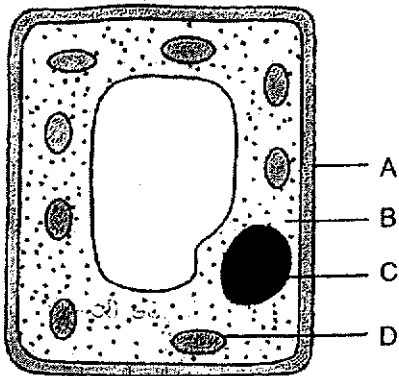

(a) Which two parts, A to D, are also found in animal cells? [1]

\_\_\_\_\_

(b) Name part B. [1]

\_\_\_\_\_

(c) State the function of part D. [1]

\_\_\_\_\_

Score	3
-------	---

30 Min Min drew diagrams 1 and 2 below showing the reproductive parts of plant M and a human respectively.

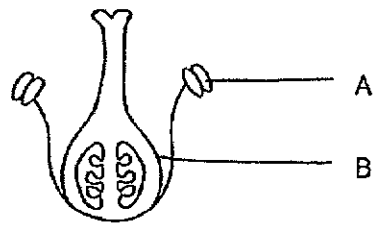

Diagram 1

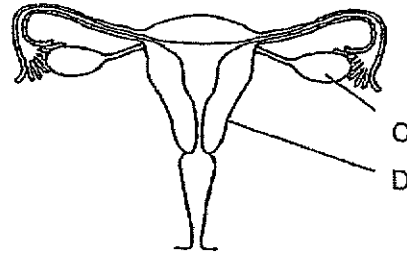

Diagram 2

(a) Which two parts, A to D, represent the ovaries in diagrams 1 and 2? [1]

\_\_\_\_\_

(b) In the population of plant M, each plant has only either blue flowers or white flowers. A farmer collected seeds from plant M with blue flowers to grow new plants. Explain why the new plants will have only blue flowers. [1]

\_\_\_\_\_  
 \_\_\_\_\_

Min Min drew another two fruits, P and Q.



P



Q

(c) State what is seed dispersal. [1]

\_\_\_\_\_

(d) How are the seeds of P and Q dispersed?

(i) P \_\_\_\_\_ (ii) Q \_\_\_\_\_

(e) State the advantage of the dispersal method used by Q to disperse its seeds. [1]

\_\_\_\_\_  
 \_\_\_\_\_

(Go on to the next page)

Score	5
-------	---

31 In his 1<sup>st</sup> attempt, Issac could easily push a sofa when no one sat on it. However, in his 2<sup>nd</sup> attempt, he found it much harder to push the sofa when Claris sat on it.

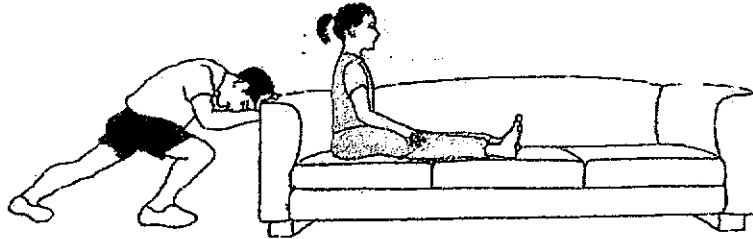

(a) Issac noticed that his breathing rate increases in his 2<sup>nd</sup> attempt as compared to his 1<sup>st</sup> attempt. Give a reason for his observation. [1]

---



---



---

Issac carried out an experiment to measure the volume of blood supplied per minute to his legs and small intestine during resting and exercising.

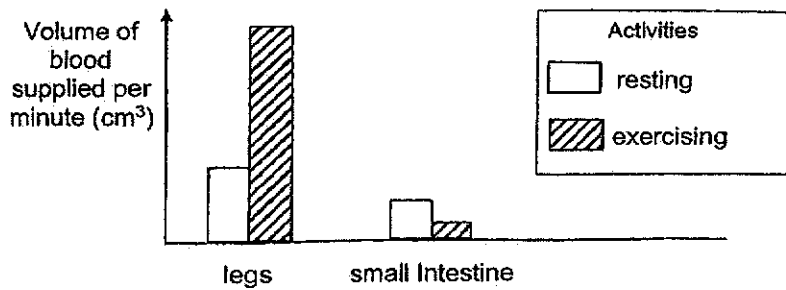

(b) Using the graph above, explain how exercising after a meal affects the absorption of digested food in the small intestine.

---



---

(c) Describe how oxygen in the environment reaches his legs. [2]

---



---



---

Score	4
-------	---



- 32 Jay cut out circular discs of equal size from a leaf. These leaf discs can still carry out their functions as a leaf for some time.

He dropped one leaf into a clear container with liquid Y placed 10 cm from the lamp. Jay switched on the lamp and started the stopwatch.

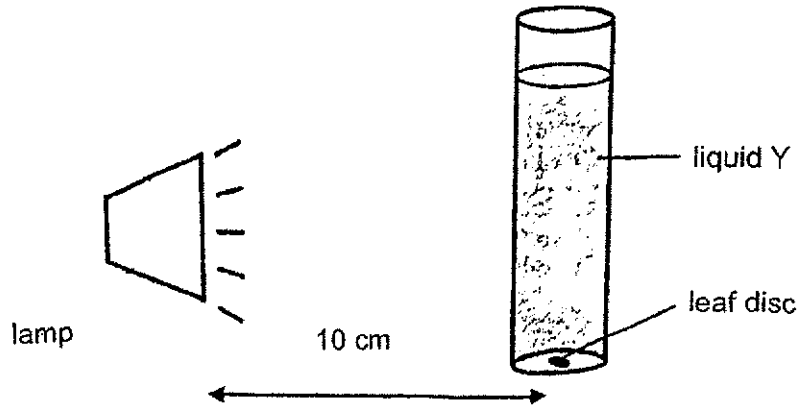

Bubbles were observed under the leaf discs after some time. Jay recorded the time taken for the disc to float to the surface of liquid Y.

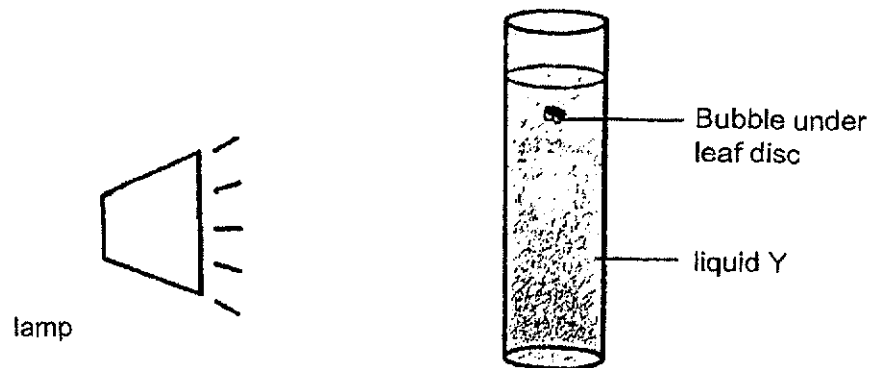

Jay repeated the experiment using fresh sets of liquid Y and leaf discs. He placed the containers at different distances using the lamp and his results are as shown.

Distance of container from lamp (cm)	Time taken for leaf disc to float to surface (s)			
	1 <sup>st</sup> Try	2 <sup>nd</sup> Try	3 <sup>rd</sup> Try	Average
10	8	7	6	7
20	16	17	18	17
30	28	27	26	27
40	25	27	29	27
50	27	27	27	27

- (a) Name the process that occurred in the leaf disc. State how the process caused the leaf disc to rise to the surface of liquid Y. [1]

---

---

---

- (b) Based on the table, what is the relationship between the distance of the container from the lamp and the time taken for the leaf disc to float to the surface? [2]

---

---

---

---

- (c) Other than repeating the experiment a few more times, what can Jay do to obtain reliable results? [1]

---

---

Score	
-------	---------------------------------------------------------------------------------------

- 33 Bird P is a pest found in large numbers in areas where people live. The droppings of birds P may carry diseases that are harmful to people.

The National Environment Agency introduced a substance S to the food of bird P in a town. The graph shows the changes in the number of births and deaths of bird P after substance S was introduced.

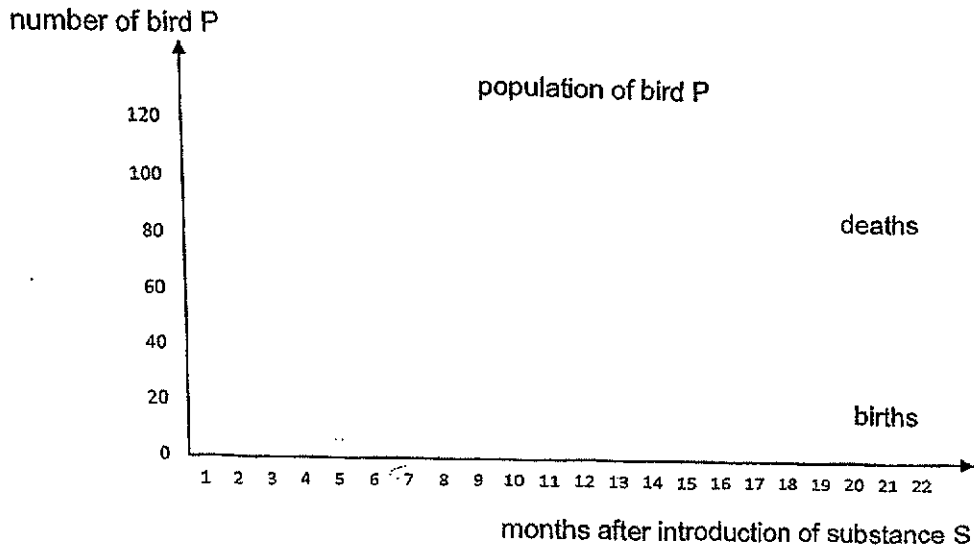

- (a) Define population. [1]

---



---

- (b) Based on the graph, suggest and explain how substance S affected the population of bird S. [2]

---



---

(Go on to the next page)

Score	3
-------	---

- 34 Yang Yang conducted an experiment to study the food relationship between animals P, X and Y. Animal P feeds on leaves only. Animals P, X and Y had no disease.

At the start of the experiment, Yang Yang placed some animals P and X in a tank with some leaves. He counted the number of animals at the end of each week. After two weeks, he added animal Y.

Yang Yang's results are shown below.

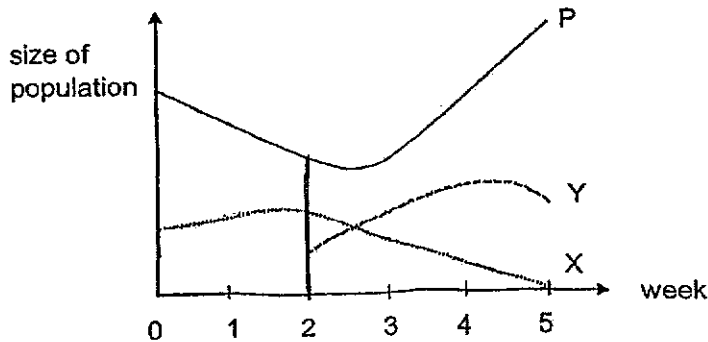

- (a) Based on the information given, draw a food chain involving a plant and animals X, Y and P. [1]

\_\_\_\_\_

- (b) Which animals, P, X or Y, is both a prey and a predator? [1]

\_\_\_\_\_

- (c) How would the populations of animal X change if there were a decrease in the population of animal Y? Give a reason. [1]

\_\_\_\_\_  
\_\_\_\_\_

Score	3
-------	---

- 35 Max wanted to find out how much light could pass through four different materials, W, X, Y and Z of similar sizes and thickness. He set up the experiment as shown below and conducted it in a dark room.

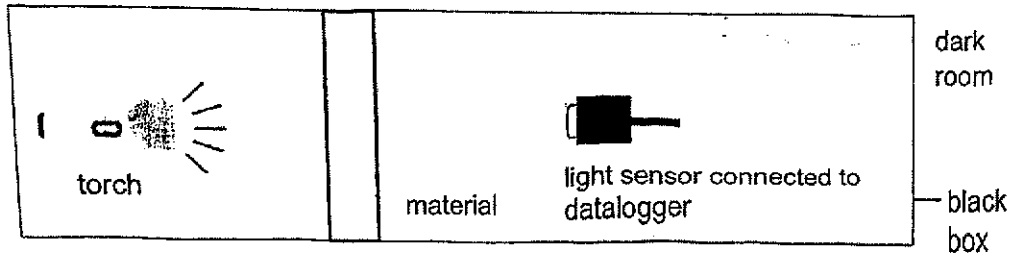

The amount of light that passed through each material was measured using a light sensor as shown in the graph below.

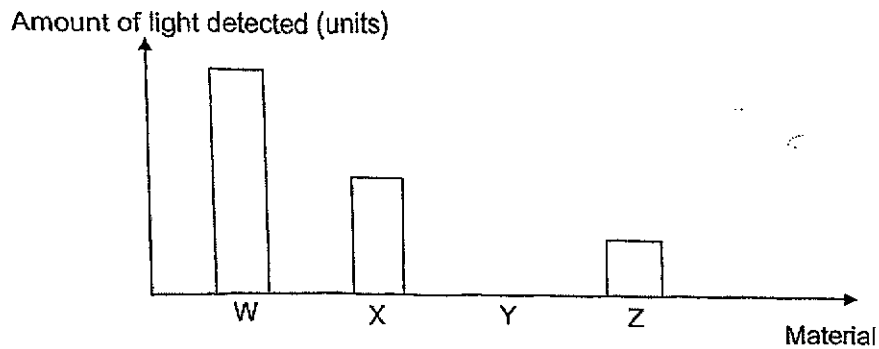

- (a) Put a tick (✓) in the correct box to identify the **changed**, **measured** and the **constant variables** in her experiment. [2]

	Variable that is changed	Variable that is measured	Constant Variable(s)
Type of materials used			
The thickness of the materials used			
The amount of light detected by the light sensor			
The amount of light shining from the torch			

- (b) Max's house is undergoing renovation and he would need to choose a material to make his toilet door.

Which material should he choose that would best make his toilet door so that he can have privacy? Explain your answer. [2]

---

---

---

Score	
-------	---------------------------------------------------------------------------------------

- 36 Jessica conducted an experiment with two identical beakers, S and T. She filled both the beakers with equal amounts of water of different temperatures and sealed the openings with similar plastic sheet. The diagram below shows her observations after ten minutes.

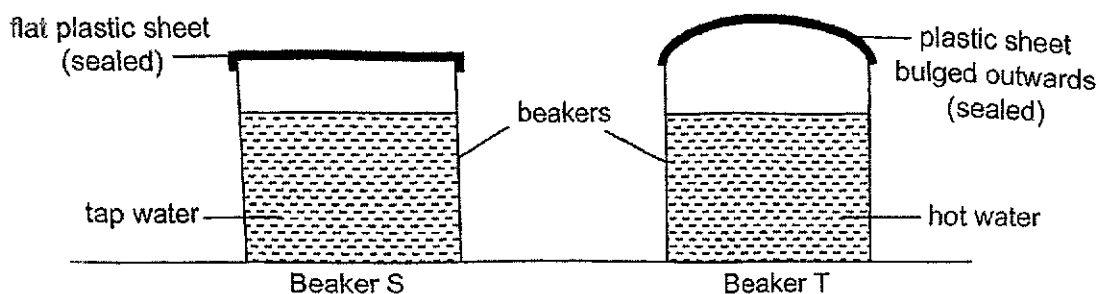

- (a) Explain why the plastic sheet on beaker T bulged outwards. [2]

---



---



---

- (b) Jessica weighed both the beakers after ten minutes using an electronic balance. Would the mass of the beaker T be less than, more than, or equal to that of beaker S? Explain your answer. [1]

---



---

- (c) Based on Jessica's experiment, state one physical property of the material used for the plastic sheet that allowed her to observe the bulge in beaker T. [1]

---



---

Score	4
-------	---

- 37 Most airlines only allow passengers to carry cabin luggages with a maximum mass of 7 kg. The diagram below shows the system used to detect a luggage if it exceeds the limitation. The light bulb would light up if the luggage has a mass of 7 kg or more.

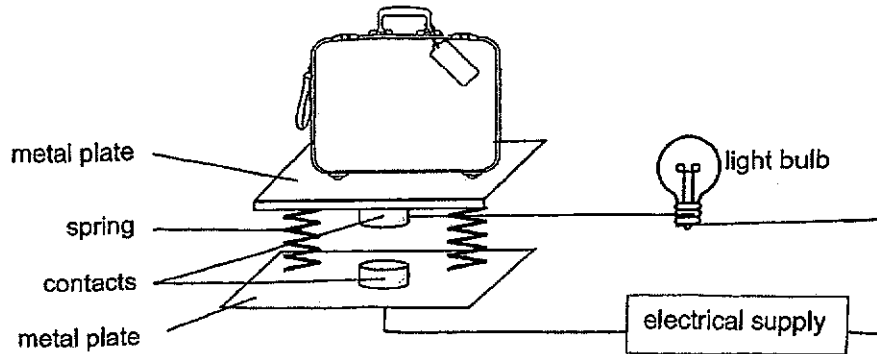

- (a) State the property of the material used to make the contacts which allows the set-up to work. Explain your answer. [2]

---



---



---

- (b) Suggest one way how the system can be changed such that passengers can now be allowed to carry a luggage with a maximum mass of 9 kg. Explain your answer. [2]

---



---



---

Score	4
-------	---



38 Adam bought a rubber band-propelled toy car as shown in the diagram below. He had to rotate the blade of the car to twist the rubber band before releasing and allowing it to move forward.

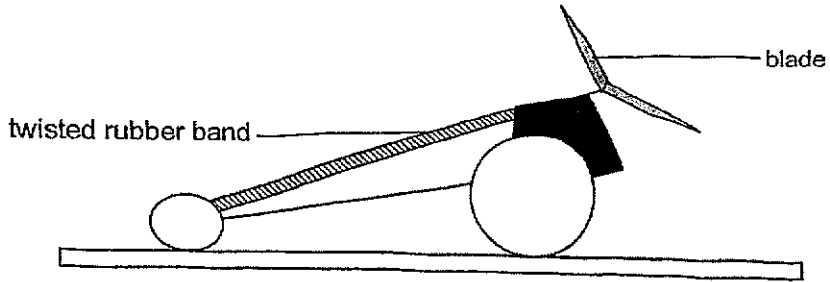

(a) Which part of the car possessed potential energy after the blade was turned? [1]

\_\_\_\_\_

(b) Without pushing the toy car, what could Adam do to increase the speed of his toy car? Explain your answer. [2]

\_\_\_\_\_  
\_\_\_\_\_  
\_\_\_\_\_

(Go on to the next page)

Score	/
	3

- 39 The set-up below was used to study the properties of three unknown objects, A, B and C. The iron rod turned into an electromagnet when the power supply was turned on.

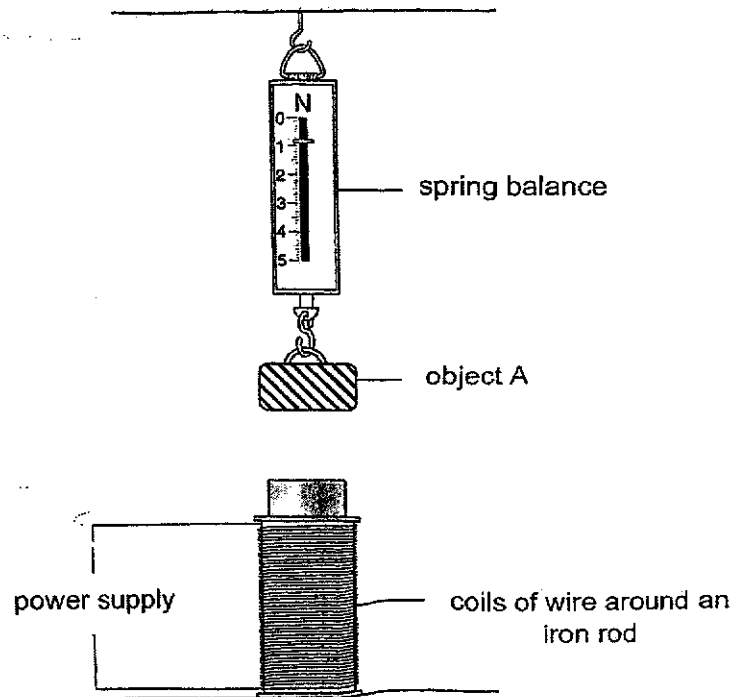

The results of the experiment are shown in the table below.

Objects	Reading of the spring balance (unit)	
	Power supply turned off	Power supply turned on
A	0.8	0.8
B	0.5	1.2
C	1.0	0.5

- (a) Based on the results, what can you infer about the material of object A? [1]
-

What are the main forces acting on object B when it was hung on the spring balance and the power supply was turned on? [1]

---

---

(c) The reading of the balanced decreased after the power supplied was turned on. Based on the results, what can you infer about object C? Explain your answer. [2]

---

---

---

---

(Go on to the next page)

Score	
-------	---------------------------------------------------------------------------------------

- 40 Alexander set up an experiment as shown below. He observed that the identical wheels in both set-ups, E and F, spun when water was dripped on them.

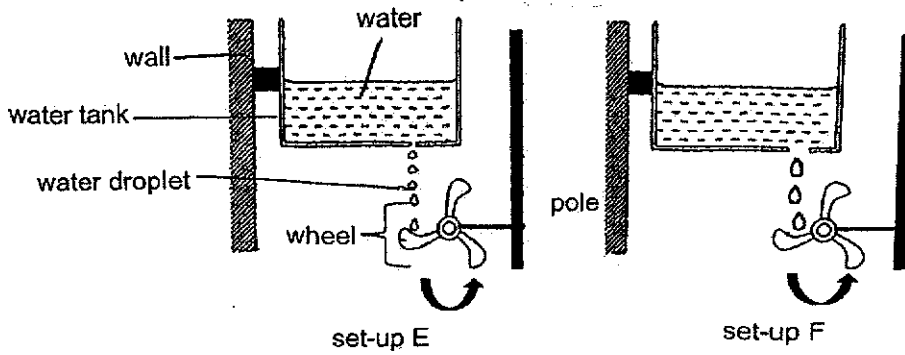

- (a) Fill in the boxes below to show the energy conversions shown in the experiment above. [1]

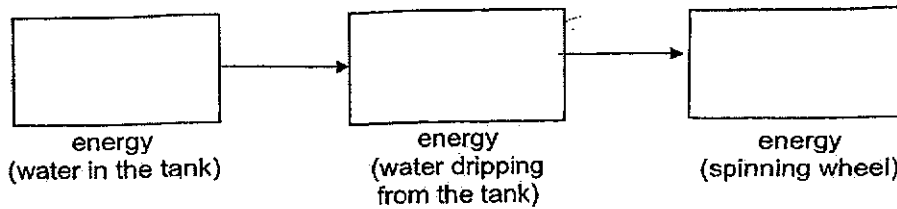

- (b) Alex observed that the wheel in set-up E spun more slowly than the wheel in set-up F. In terms of forces, explain this observation. [2]

---



---



---

Score	3
-------	---

NAN HUA PRIMARY SCHOOL  
NWA2 2024  
PRIMARY SIX  
SCIENCE  
Student Answer Key

Section A (28x2) = 56marks

Qns	Ans	Qns	Ans	Qns	Ans
1	1	11	1	21	4
2	3	12	3	22	2
3	2	13	2	23	4
4	4	14	3	24	3
5	2	15	3	25	4
6	1	16	1	26	4
7	3	17	4	27	1
8	3	18	3	28	2
9	2	19	2		
10	2	20	1		

**Section B (44 marks)**

Qns	Student Answer Key
29a	B and C
29b	Cytoplasm
29c	It contains chlorophyll which <u>traps/absorbs/captures light</u> and <u>make/produce food/sugar/glucose</u> for the plant.
30a	B and C
30b	The parent plant K has <u>the characteristic of blue flowers</u>  This characteristic can be <u>passed down from the parents to their young.</u>
30c	Seed dispersal is the <u>scattering/movement of seeds away from the parent plants.</u>
30d	(i) wind  (ii) <u>splitting method/explosive action.</u>
30e	Q <u>does not need to depend/rely on other agents of dispersal.</u>  OR  Q <u>does not need to depend/rely on external factors.</u>
31a	His breathing rate increases to <u>take in more oxygen</u> and <u>remove more carbon dioxide to produce/release more energy.</u>

31b	<p>The volume of blood supplied to the small intestine <u>decreases</u>. The amount of digested food absorbed into the bloodstream <u>decreases</u>.</p> <p>Or</p> <p>The rate of absorption of digested food into the bloodstream <u>decreases</u></p>
31c	<p>Oxygen taken in from the air enters/absorbs into the lungs (through the nose). <u>Oxygen is absorbed into the bloodstream and gets transported to the legs.</u></p>
32a	<p>Photosynthesis.</p> <p>Oxygen produced <u>pushes</u> the leaf disc upwards.</p>
32b	<p>As the distance of container from lamp <u>increases from 10 cm to 30 cm</u>, the time taken for the leaf disc to float to the surface <u>increases</u>.</p> <p>However, as the distance of container from lamp <u>increases from 30 cm to 50 cm</u>, the time taken for the leaf disc to float to the surface <u>stays constant</u>.</p>
32c	<p>He can <u>place more leaf discs</u> in each of his try and <u>take the average</u>.</p>
33a	<p>A population is defined as a <u>group of plants and/or animals of the same kind, living and reproducing at a given place</u> and time.</p>
33b	<p>Substance S causes <u>a decrease in the birth rate but does not affect the death rate.</u></p>

	<p>Substance S <u>prevented bird P from reproducing/laying eggs</u> that will hatch, causing the population of P to decrease over the months.</p> <p>OR</p> <p><u>Less eggs laid will hatch</u>, causing the population of P to decrease over the months.</p>																				
34a	Plant → P → X → Y																				
34b	Animal X.																				
34c	<p>When the population of animal Y decreases, there will be <u>less Y feeding on animal X</u>.</p> <p>So there will be <u>more animal X to reproduce</u> and <u>increase in its population</u>.</p>																				
35a	<table border="1" data-bbox="343 996 949 1590"> <thead> <tr> <th></th> <th>Variable that is changed</th> <th>Variable that is measured</th> <th>Constant Variable(s)</th> </tr> </thead> <tbody> <tr> <td>Type of materials used</td> <td></td> <td></td> <td></td> </tr> <tr> <td>The thickness of the materials used</td> <td></td> <td></td> <td></td> </tr> <tr> <td>The amount of light detected by the light sensor</td> <td></td> <td></td> <td></td> </tr> <tr> <td>The amount of light shining from the torch</td> <td></td> <td></td> <td>✓</td> </tr> </tbody> </table>		Variable that is changed	Variable that is measured	Constant Variable(s)	Type of materials used				The thickness of the materials used				The amount of light detected by the light sensor				The amount of light shining from the torch			✓
	Variable that is changed	Variable that is measured	Constant Variable(s)																		
Type of materials used																					
The thickness of the materials used																					
The amount of light detected by the light sensor																					
The amount of light shining from the torch			✓																		



35b	<p><b>Choice:</b> <u>Material Y</u></p> <p><b>Evidence:</b> <u>No amount of light is detected</u> by the light sensor.</p> <p><b>Concept:</b> Material Y is <u>opaque, / does not allow any light to pass through.</u></p> <p>Link: so that he could have privacy.</p>
36a	<p>There is <u>air</u> occupying the space <u>inside beaker T</u>. The air <u>gained heat from the hot water</u> and <u>expanded</u>. There was <u>not enough space</u> for the air inside the beaker, hence the plastic sheet bulged outwards.</p>
36b	<p>The mass of beaker T is <u>the same</u> as beaker S.</p> <p><u>The amount of matter/ water and air</u> in both beakers <u>remains the same.</u></p>
36c	Flexible
37a	<p>The contacts must be <u>an electrical conductor.</u></p> <p>This will form a <u>closed circuit to allow the bulb to light up/electric current flow through the light bulb to light up</u></p>
37b	<p>Change the spring to a <u>stiffer spring.</u></p> <p>A <u>greater force/heavier weight/ heavier load</u> is needed to compress the spring to the same extent/ for the <u>contact to touch</u>. Hence a <u>luggage of a greater mass</u> can be placed on metal plate.</p>

38a	<u>Twisted/stretched</u> rubber band
38b	<p>Choice:</p> <p>Turn the rubber band <u>a few more times/add one more rubber band to the toy car/stiffer rubber band/use a shorter rubber band/use a lubricant</u></p> <p>Concept:</p> <p>The rubber band will possess <u>more (elastic) potential energy</u>. This results in <u>more (elastic) potential energy in the rubber band</u> to be <u>converted to more kinetic energy of the toy car</u>, enabling the toy car to move faster.</p> <p>For lubricant answer:</p> <p>There is <u>less frictional force between the wheels and the ground</u>.</p>
39a	Object A is a <u>non-magnetic material</u> ./ Object A cannot be attracted by the electromagnet.
39b	<u>Elastic spring force, gravitational force/weight and magnetic force of attraction</u>
39c	<p>Concept:</p> <p>Object C is a <u>magnet</u>.</p> <p>Evidence:</p> <p><u>The push force exerted on object C by the electromagnet</u> causes the reading on the balance to decrease.</p> <p>Concept:</p> <p>The <u>like poles</u> of the magnet and the electromagnet/magnetised iron rod <u>are facing each other so they repel</u>.</p>
40a	(Gravitational) potential energy → Kinetic energy → Kinetic energy

40b	<p>Evidence: <u>The opening in the water tank in set-up E is smaller than the opening in set-up F so the mass of the dripping water droplets in set-up E was less than that in set-up F.</u></p> <p>Concept: <u>Less force acts on the wheel/less weight is exerted on the wheel.</u></p> <p>Link: Therefore, the wheel in set-up E spun more slowly.</p>
-----	-----------------------------------------------------------------------------------------------------------------------------------------------------------------------------------------------------------------------------------------------------------------------------------------------------------------------------------------------------------------------

