

Name

Reg. No

Class



MAYFLOWER SECONDARY SCHOOL MAYFLOWER SECONDARY SCHOOL MAYFLOWER SECONDARY SCHOOL MAYFLOWER SECONDARY SCHOOL MAYFLOWER SECONDARY SCHOOL
 MAYFLOWER SECONDARY SCHOOL MAYFLOWER SECONDARY SCHOOL MAYFLOWER SECONDARY SCHOOL MAYFLOWER SECONDARY SCHOOL MAYFLOWER SECONDARY SCHOOL
 MAYFLOWER SECONDARY SCHOOL MAYFLOWER SECONDARY SCHOOL MAYFLOWER SECONDARY SCHOOL MAYFLOWER SECONDARY SCHOOL MAYFLOWER SECONDARY SCHOOL
 MAYFLOWER SECONDARY SCHOOL MAYFLOWER SECONDARY SCHOOL MAYFLOWER SECONDARY SCHOOL MAYFLOWER SECONDARY SCHOOL MAYFLOWER SECONDARY SCHOOL
 MAYFLOWER SECONDARY SCHOOL MAYFLOWER SECONDARY SCHOOL MAYFLOWER SECONDARY SCHOOL MAYFLOWER SECONDARY SCHOOL MAYFLOWER SECONDARY SCHOOL
 MAYFLOWER SECONDARY SCHOOL MAYFLOWER SECONDARY SCHOOL MAYFLOWER SECONDARY SCHOOL MAYFLOWER SECONDARY SCHOOL MAYFLOWER SECONDARY SCHOOL
 MAYFLOWER SECONDARY SCHOOL MAYFLOWER SECONDARY SCHOOL MAYFLOWER SECONDARY SCHOOL MAYFLOWER SECONDARY SCHOOL MAYFLOWER SECONDARY SCHOOL
 MAYFLOWER SECONDARY SCHOOL MAYFLOWER SECONDARY SCHOOL MAYFLOWER SECONDARY SCHOOL MAYFLOWER SECONDARY SCHOOL MAYFLOWER SECONDARY SCHOOL

3EX

PHYSICS

6091/01

Paper 1 Multiple Choice [25 Marks]

SEMESTER TWO EXAMINATION
October 2019

Additional Materials: OTAS

**2 hour 15 minutes
(with Paper 2)**

Instructions to Candidates

Do not start reading the questions until you are told to do so.

Write in soft pencil.

Do not use staples, paper clips, highlighters, glue or correction fluid.

Write your name, class, and index number on the OTAS provided.

DO NOT WRITE IN ANY BARCODES.

Information for Candidates

 There are **twenty-five** questions on this paper. Answer **all** questions.

 For each question there are four possible answers **A, B, C** and **D**.

 Choose the **one** you consider correct and record your choice in **soft pencil** on the **OTAS**.

Read the instructions on the OTAS very carefully.

Each correct answer will score one mark. A mark will not be deducted for a wrong answer.

Any rough working should be done in this booklet.

The use of an approved scientific calculator is expected, where appropriate.

 Unless otherwise stated, take the gravitational field strength on earth g to be 10.0 N/kg .

 This question paper consists of **10** printed pages.

Setter: Mrs Neo PH

Vetter: Mr Johnson Tay

PartnerInLearning

 More papers at www.bestpapersfree.com

Section A

Answer all the questions in the OTAS provided.

1 Which row shows the correct SI units of base quantities?

- A ampere, kilogram, hour, volt
- B ampere, kilogram, kilometre, second
- C kelvin, metre, gram, second
- D kelvin, metre, second, volt

2 The following diagram shows part of a vernier scale.

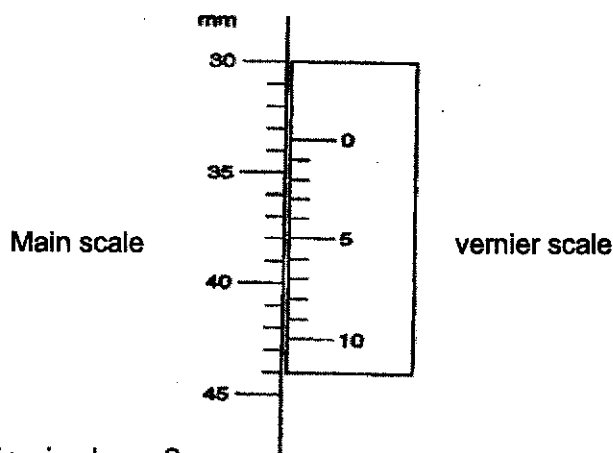

What reading is shown?

- A 3.35 cm
- B 4.25 cm
- C 30.5 mm
- D 42.5 mm

3 The diagram below shows two identical marbles X and Y entering two different tracks A and B respectively with the same initial speed of 4.0 m/s. Assume all the surfaces involved are frictionless.

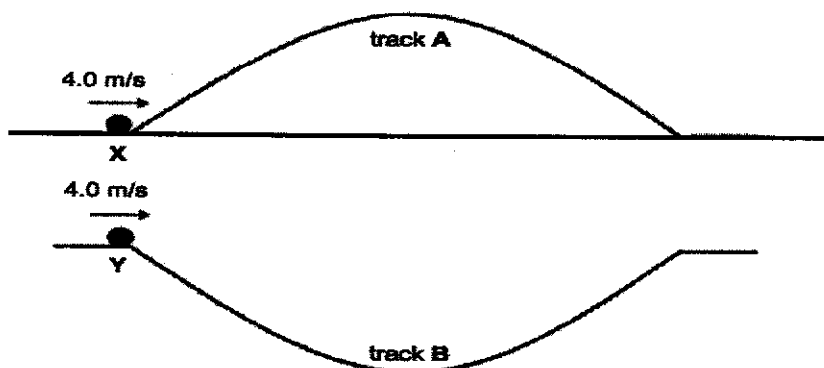

Given that tracks A and B are mirror images of each other, which of the following statements is true?

- A The final velocity of Y is higher than the final velocity of X.
- B X and Y reach the other end of the track at the same time.
- C X reaches the other end of the track before Y.
- D Y reaches the other end of the track before X.

- 4 Two iron balls, X and Y, are dropped from a building at different heights. It is found that the time taken for iron ball X to reach the floor is twice the time taken for iron ball Y.

Assuming negligible air resistance, what is the ratio of the distance travelled by iron ball X to iron ball Y?

- A 1 : 2 B 1 : 4 C 2 : 1 D 4 : 1

- 5 A skydiver jumps from an aeroplane. After a few seconds, he reaches a terminal velocity without opening his parachute.

Why does he reach terminal velocity?

- A Air resistance becomes greater than his weight and slows him down.
 B Air resistance decreases and he speeds up.
 C Air resistance increases and balances his weight so that his acceleration is zero.
 D His weight decreases and balances the air resistance.

- 6 A steel ball bearing has a mass of 24 g and a density of 8.0 g/cm^3 . It is lowered into a measuring cylinder containing 12 cm^3 of water.

What is the new water level in the cylinder?

- A 3.0 cm^3 B 4.0 cm^3 C 15.0 cm^3 D 16.0 cm^3

- 7 The table shows the gravitational field strength of a 1 kg mass on each of four planets.

Planet	Gravitational Field Strength / (N/kg)
Earth	10
Jupiter	25
Mercury	4
Venus	9

The diagram below shows a force meter (spring balance) being used.

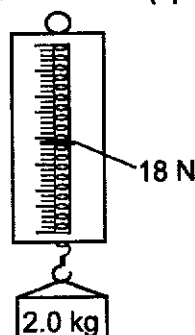

On which planet is the force meter being used?

- A Earth B Jupiter C Mercury D Venus

[Turn over

- 8 The centre of gravity of an object of uniform thickness is determined on Earth and on the Moon. The Moon has a gravitational field strength one-sixth that of Earth.

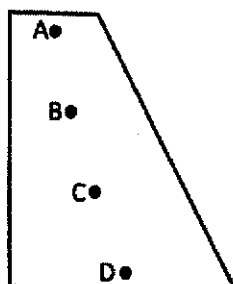

Where is the centre of gravity (c.g.) on Earth and on the Moon?

	c.g. on Earth	c.g. on Moon
A	B	B
B	C	B
C	C	C
D	D	C

- 9 A bullet of mass 0.030 kg passes through a piece of wood and slows down from 500 m/s to 200 m/s. What is the kinetic energy loss by the bullet?

A 600 J **B** 1350 J **C** 3150 J **D** 3750 J

- 10 A motor drives a pump that raises 0.20 m³ of water by 5.0 m in 10 minutes. The density of water is 1 000 kg/m³.

If the efficiency of the pump is 75%, what is the power input by the motor?

A 16.7 W **B** 22.2 W **C** 556 W **D** 1 330 W

- 11 The diagram shows a conical vessel full of water. The pressure at point X due to the water is p . Point Q is a distance h above point X.

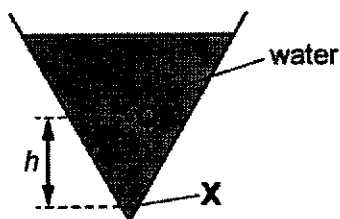

Which graph shows how the pressure due to the water at Q varies with distance h ?

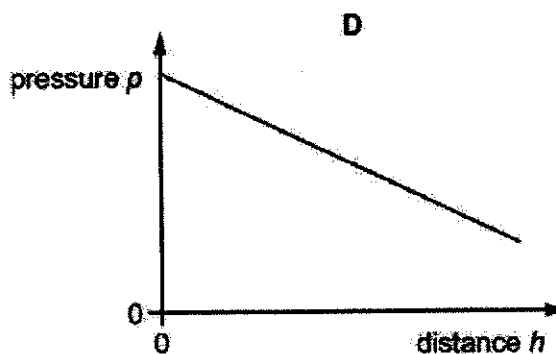
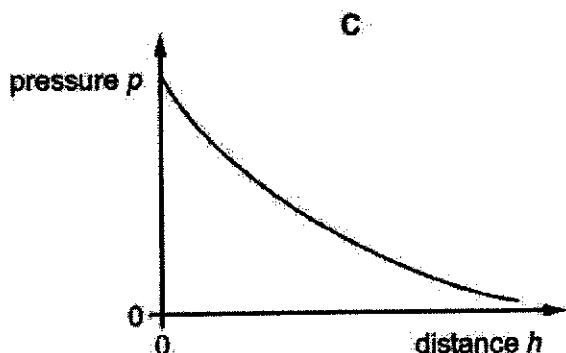
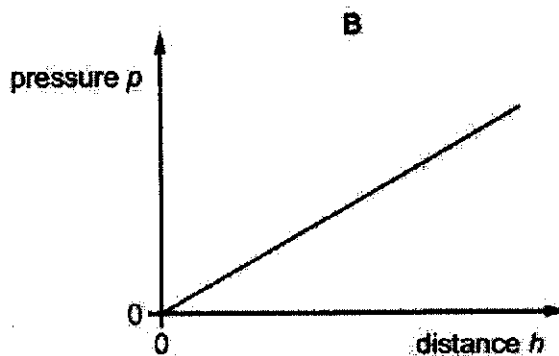
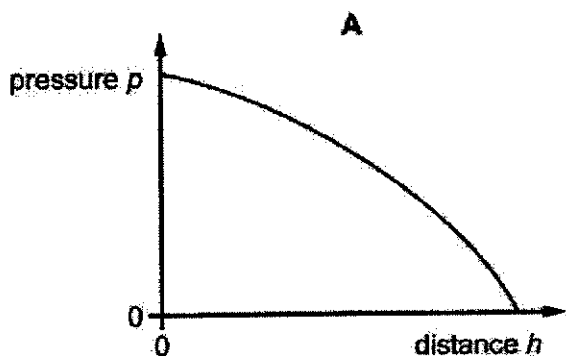

- 12 The diagram shows a plunger in a container and moves to the left.

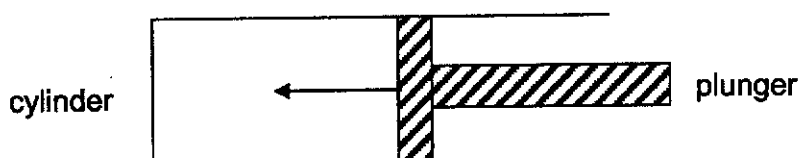

Which of the following explains why the pressure of the gas inside the cylinder increases?

- A** density of the gas increases
- B** gas molecules collide with each other more often
- C** gas molecules speed up
- D** gas molecules strike the cylinder walls more often

[Turn over

- 13 The lengths of mercury thread in a uniform tube above the bulb of a mercury-in-glass thermometer are as follows:

- 20 mm when the bulb is in melting ice
- 120 mm when the bulb is in steam above boiling water
- 40 mm when the bulb is in sea water

What is the approximate temperature of sea water?

- A 20 °C B 33 °C C 40 °C D 80 °C

- 14 A student attempts to build a thermocouple. The figure shows how the e.m.f., ϵ , of his thermocouple varies with temperature θ . The student wants to use his thermocouple to measure the required temperature range indicated in the graph below.

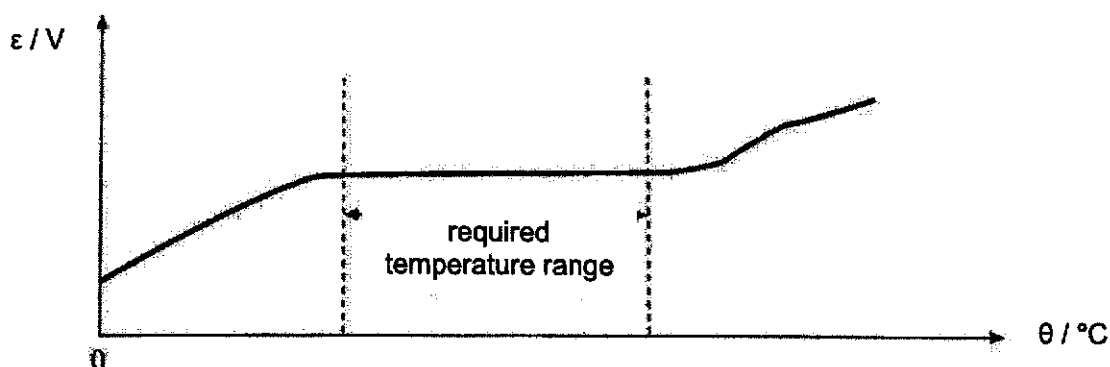

Why is the thermocouple not suitable for measuring the required temperature range as shown above?

- A The e.m.f. values for different temperatures are not unique.
 B The graph is directly proportional for the required temperature range.
 C The ice point is not within the required temperature range.
 D The required temperature range does not span the whole horizontal axis.
- 15 An illuminated smoke particle, suspended in air, is viewed with a microscope. It is seen to move randomly as shown below.

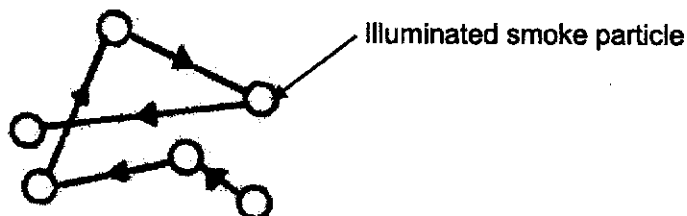

What does the motion of smoke particle tell us about the molecular movement of air molecules?

- A air molecules are in continuous motion
 B air molecules move in clusters
 C air molecules move just as fast as smoke particles
 D air molecules have the same amount of average kinetic energy at different temperatures

16 When a liquid evaporates, the temperature of the liquid decreases.

Which of the following statements explain why the temperature decreases?

- A** Air molecules lose heat by colliding with the water surface.
- B** Fewer molecules are left in the liquid.
- C** Heat energy is lost by radiation.
- D** Some of the most energetic molecules leave the liquid.

17 Which of the following observations shows that conduction is the main mode of heat transfer?

- A** Barbeque sausage usually has a burnt pattern like the barbeque mesh when left unattended for some time.
- B** Food in microwave oven seldom takes more than 3 minutes to cook.
- C** Heating the base of a test tube of water with some ice floating at the top of the tube usually takes some time for the ice to melt.
- D** People sitting around a camp fire feel the heat.

18 Which of the following methods would not produce convection currents in a container filled with water at 30 °C?

- A** dropping a piece of hot metal into the water
- B** floating a piece of ice on the water
- C** lighting a candle beneath the container
- D** placing a 100 W lighted bulb just above the water surface

[Turn over

- 19 A double-glazed window has two sheets of glass separated by a layer of air. Thermal energy is lost through conduction and convection through the layer of air. The amount of conduction and convection varies with the thickness of the layer of air, as shown in the graph.

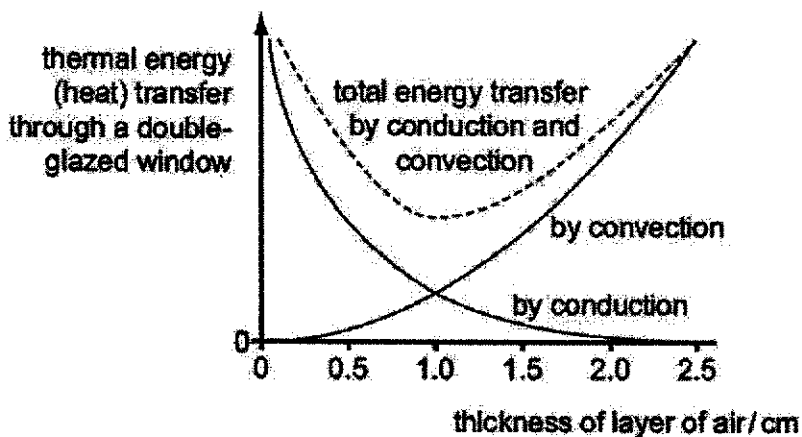

Which thickness of air produces the smallest thermal energy transfer, and why?

- A 0.0, because there is little thermal energy transfer by convection.
 B 1.0 cm, because the total thermal energy transfer is least
 C 1.5 cm, because the thermal energy transfer by conduction is less significant than that by convection.
 D 2.5 cm, because there is little thermal energy transfer by conduction.
- 20 The graph shows the change of temperature of 2.0 kg of a substance with time when 80 000 J/min of heat is applied to it.

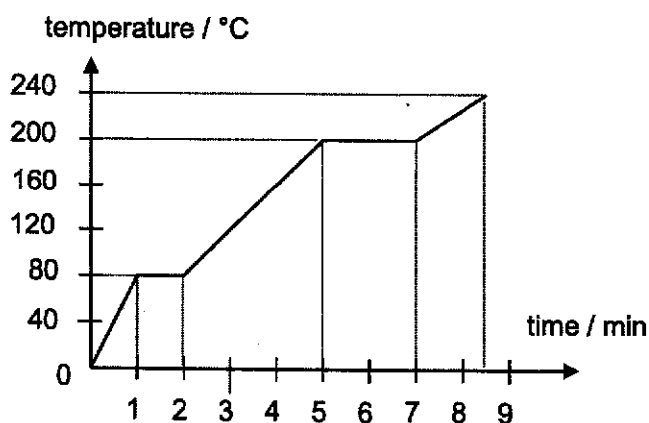

What is the specific latent heat of vaporization of the substance?

- A 20 kJ/kg B 40 kJ/kg C 60 kJ/kg D 80 kJ/kg

- 21 The diagram below shows a plane mirror placed at distance of 300 cm in front of the patient. If the optician's test card is fixed at 80 cm behind the eyes of the patient.

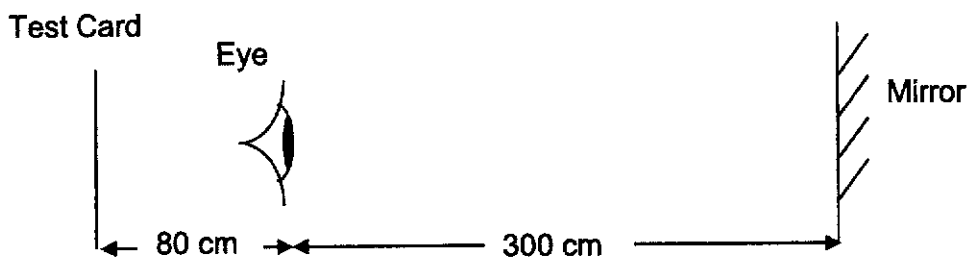

What is the distance from his eyes to the image of the card?

- A 300 cm B 380 cm C 680 cm D 760 cm
- 22 Which source generates longitudinal waves?

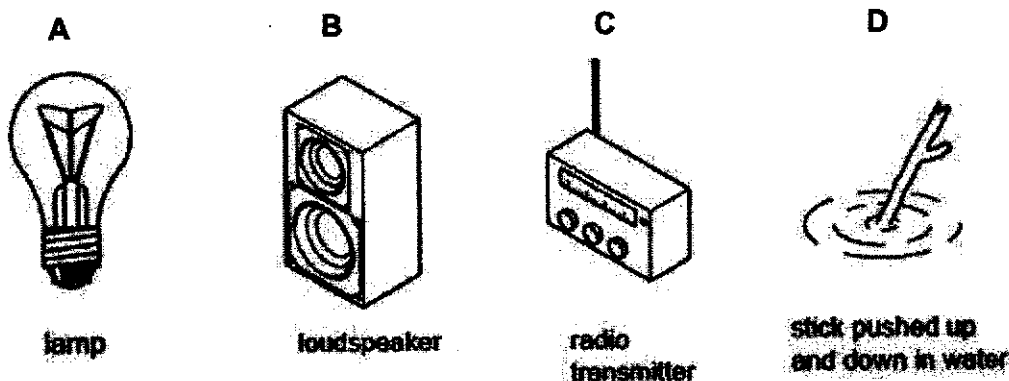

- 23 A thin converging lens is used to produce a focused image of a candle on a screen.

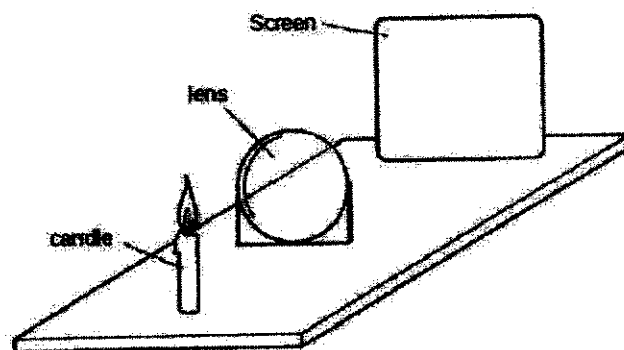

Various focused images are produced on the screen by moving the lens and the screen backwards and forwards.

Which one of the following statements is always correct?

- A The image is inverted.
 B The image is bigger than the object.
 C The image is closer to the lens than the object is.
 D The image is at the principal focus (focal point) of the lens.

[Turn over

- 24 The diagram shows part of a spring that is shaken from side-to-side to produce a wave.

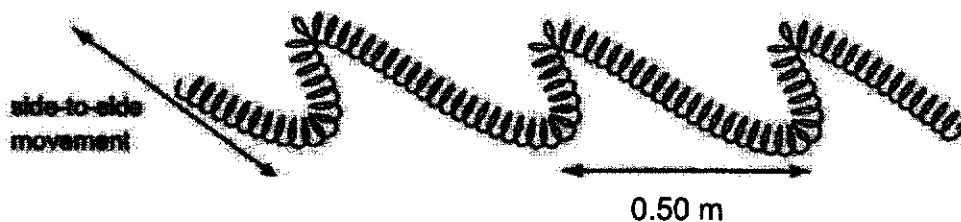

The wavelength of the above wave is 0.50 m and the frequency is 1.2 Hz.

How long does it take for a wave to travel 3.0 m along the spring?

- A 0.20 s B 0.50 s C 2.0 s D 5.0 s
- 25 Which one of the following values can possibly be the wavelength of X-rays given that the wavelength of red light is 700 nm?
- A 5×10^{-2} m B 5×10^{-5} m C 5×10^{-7} m D 5×10^{-10} m

- End of Paper 1 -

Name

Reg. No

Class



MAYFLOWER SECONDARY SCHOOL MAYFLOWER SECONDARY SCHOOL MAYFLOWER SECONDARY SCHOOL MAYFLOWER SECONDARY SCHOOL MAYFLOWER SECONDARY SCHOOL
 MAYFLOWER SECONDARY SCHOOL MAYFLOWER SECONDARY SCHOOL MAYFLOWER SECONDARY SCHOOL MAYFLOWER SECONDARY SCHOOL MAYFLOWER SECONDARY SCHOOL
 MAYFLOWER SECONDARY SCHOOL MAYFLOWER SECONDARY SCHOOL MAYFLOWER SECONDARY SCHOOL MAYFLOWER SECONDARY SCHOOL MAYFLOWER SECONDARY SCHOOL
 MAYFLOWER SECONDARY SCHOOL MAYFLOWER SECONDARY SCHOOL MAYFLOWER SECONDARY SCHOOL MAYFLOWER SECONDARY SCHOOL MAYFLOWER SECONDARY SCHOOL
 MAYFLOWER SECONDARY SCHOOL MAYFLOWER SECONDARY SCHOOL MAYFLOWER SECONDARY SCHOOL MAYFLOWER SECONDARY SCHOOL MAYFLOWER SECONDARY SCHOOL
 MAYFLOWER SECONDARY SCHOOL MAYFLOWER SECONDARY SCHOOL MAYFLOWER SECONDARY SCHOOL MAYFLOWER SECONDARY SCHOOL MAYFLOWER SECONDARY SCHOOL
 MAYFLOWER SECONDARY SCHOOL MAYFLOWER SECONDARY SCHOOL MAYFLOWER SECONDARY SCHOOL MAYFLOWER SECONDARY SCHOOL MAYFLOWER SECONDARY SCHOOL
 MAYFLOWER SECONDARY SCHOOL MAYFLOWER SECONDARY SCHOOL MAYFLOWER SECONDARY SCHOOL MAYFLOWER SECONDARY SCHOOL MAYFLOWER SECONDARY SCHOOL

3EX**PHYSICS****6091/02**

Paper 2 Theory [75 Marks]

SEMESTER TWO EXAMINATION**October 2019**

No Additional Materials are required.

**2 hour 15 minutes
(with Paper 1)****Instructions to Candidates**

Write your name, class, and index number on all the work you hand in.

Write in dark blue or black pen on both sides of the paper.

You may use a pencil for any diagrams or graphs.

Do not use staples, paper clips, highlighters, glue or correction fluid.

DO NOT WRITE IN ANY BARCODES.**Section A**

Answer all questions.

Section B

Answer all questions. Question 11 has a choice of parts to answer.

Candidates are reminded that all quantitative answers should include appropriate units.

The use of an approved scientific calculator is expected, where appropriate.

Candidates are advised to show all their working in a clear and orderly manner, as more marks are awarded for sound use of Physics than for correct answers.

Unless otherwise stated, take the gravitational field strength on earth g to be 10 N/kg.

At the end of the examination, fasten all your work securely together.

The number of marks is given in brackets [] at the end of each question or part question.

FOR EXAMINER'S USE		
Paper		Marks
Paper 1 (MCQ)		/ 25
Paper 2		/
A		/ 45
B	Q __	/ 10
	Q __	/ 10
	Q __	/ 10
Total		/ 100

This question paper consists of 19 printed pages.

Setter: Mrs Neo PH

Vetter: Mr Johnson Tay

Section A

Answer all the questions in this section.

- 1 A pendulum is set to oscillate as shown in Fig. 1.1.

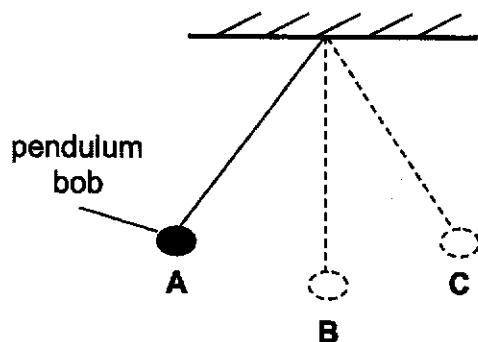

Fig. 1.1

- (a) Describe the energy transformation as the pendulum swings from A to B to C as shown in Fig. 1.1.

.....
 [1]

- (b) On Fig. 1.2, sketch the speed-time graph of complete oscillation of the pendulum. [1]

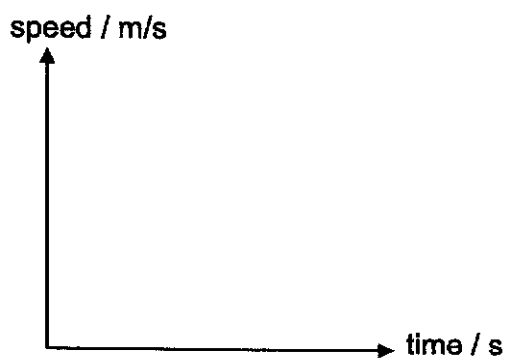

Fig. 1.2

- (c) The length of the pendulum is increased. On Fig 1.2, sketch a new line to show the new speed-time graph and label this line 'X'. [1]

- 2 Fig. 2.1 below shows a car braking system. The brake drum rotates with the wheel of the car. When the driver's foot pushes on the pedal, it causes the brake shoe to rub against the drum and the car stops.

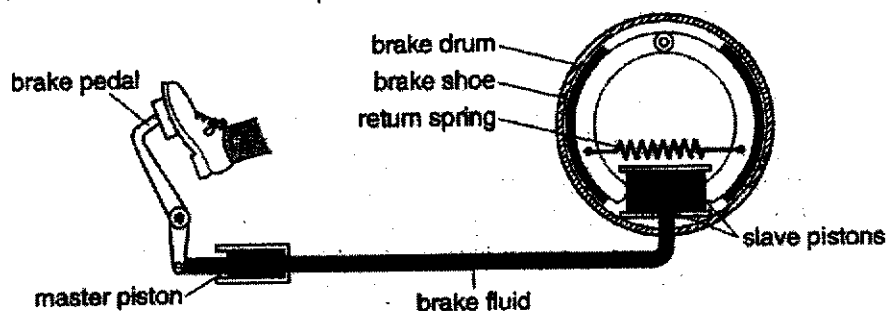

Fig. 2.1

- (a) (i) Explain briefly, in terms of pressure and forces, what happens when the driver's foot pushes on the brake pedal.

.....

.....

.....

.....

..... [3]

- (ii) The brake fluid used in the pipes is oil. Explain why air is not used.

.....

..... [1]

- (b) The area of the master piston is 2.0 cm^2 . The driver's foot applies a force of 140 N on the master piston. The area of each of the slave pistons is 2.8 cm^2 .

- (i) Calculate the pressure, in N/cm^2 , created in the brake fluid by the master piston.

pressure = [2]

- (ii) Hence, calculate the force exerted on one slave piston by the brake fluid.

force = [1]

[Turn over

- 3 The displacement-time graph of the tennis ball rolling on a flat ground is shown in Fig. 3.2.

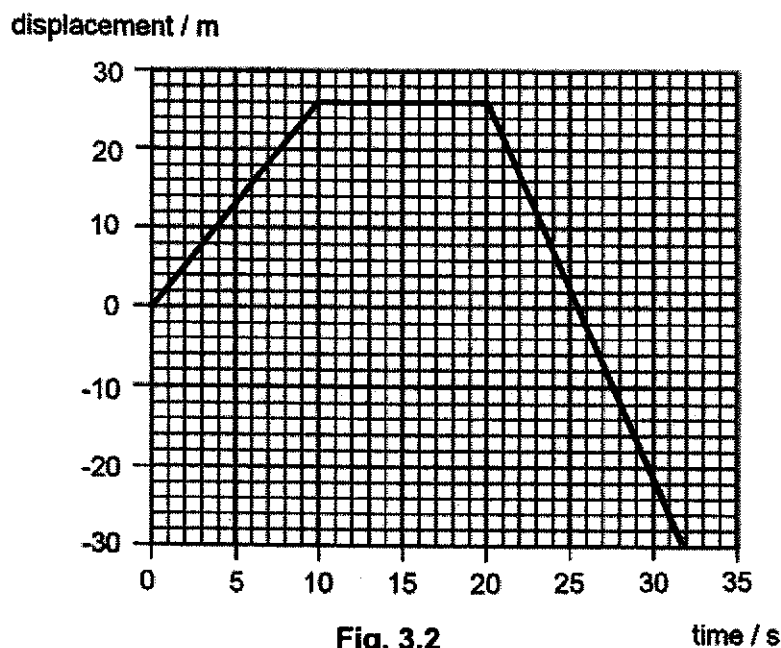

- (a) Displacement is a vector quantity.

Explain the difference between scalar quantities and vector quantities.

.....
 [1]

- (b) Calculate the total distance travelled by the ball from 0 s to 32 s

total distance = [1]

- (c) Describe the motion of the tennis ball from 0 s to 32 s.

.....

 [3]

4 (a) A stationary object is acted upon by a number of forces.

State the condition(s) which must be true if the object

(i) does not accelerate,

.....[1]

(ii) does not rotate.

.....[1]

(b) Fig. 4.1 shows a boat that has been lifted out of a river. The boat is suspended by two ropes.

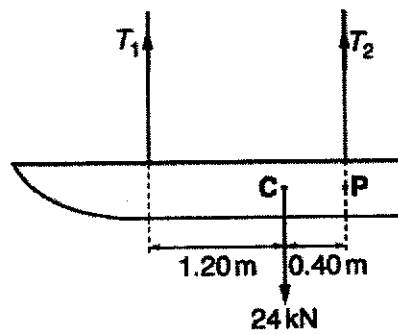

Fig. 4.1 (not to scale)

The weight of the boat, acting at the centre of gravity, is 24 kN. The tensions in the ropes are T_1 and T_2 .

Determine

(i) the moment of the weight of the boat about the point P,

moment =[1]

(ii) the tension T_1 ,

$T_1 = \dots\dots\dots$ [2]

(iii) the tension T_2 .

$T_2 = \dots\dots\dots$ [1]

[Turn over

- 5 Fig. 5.1 shows two vertical tubes P and Q, each closed at the upper end. The pressure in the space above the mercury meniscus in tube P is negligible. There is a small amount of air in this space in the tube Q. The density of mercury is $13.6 \times 10^3 \text{ kg/m}^3$.

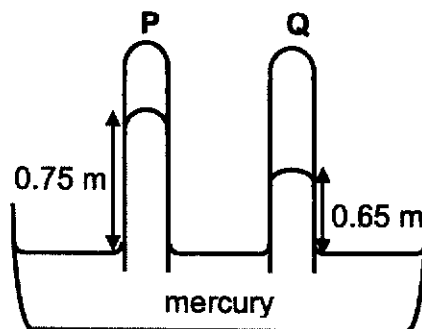

Fig. 5.1

- (a) Calculate the atmospheric pressure, in Pa.

pressure =[2]

- (b) Hence, calculate the pressure exerted by the air above the mercury in tube Q.

pressure =[2]

- (c) Tube Q is now pushed downwards by 0.10 m.

Explain why the height of mercury in the tube decreases.

.....

 [2]

- 6 A small amount of crushed ice was placed in a container and allowed to warm up from a temperature of $-2\text{ }^{\circ}\text{C}$ to $2\text{ }^{\circ}\text{C}$. Fig. 6.1 shows how the temperature of the ice varied with time.

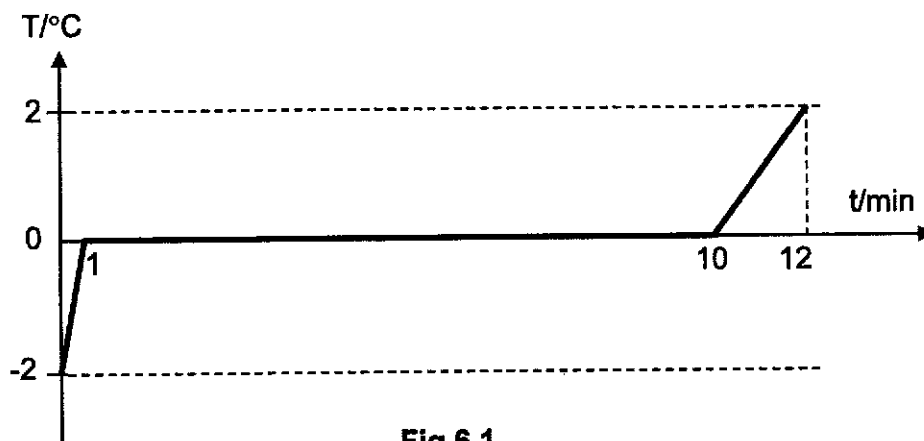

Fig 6.1

Using the Kinetic Theory of Matter,

- (a) explain why, after an initial rise to $0\text{ }^{\circ}\text{C}$, the temperature remained constant for a long time even though heat is still being absorbed by the ice.

.....

.....

.....

..... [2]

- (b) describe the change in the motion of the particles and the separation between the particles of the ice between $t = 10$ min and $t = 12$ min.

.....

.....

.....

..... [2]

- (c) state how the internal energies are changed between $t = 1$ min and $t = 10$ min.

.....

..... [1]

A student prepares a cup of hot coffee with a mass 0.35 kg at 95 °C. She chooses a white cup to contain the coffee. She then covers it with a lid and places the cup on a cork coaster above the table surface as shown in Fig. 7.1.
(Specific heat capacity of coffee = 4 200 J/kg°C)

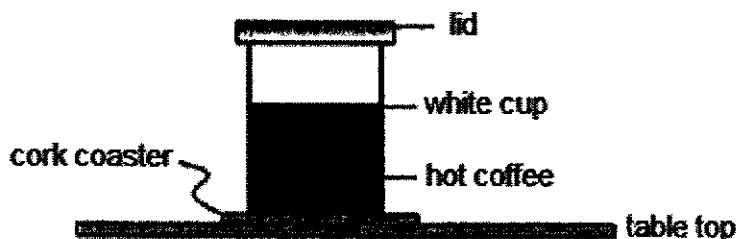

Fig. 4.1

- (a) Explain two ways in which the cup reduces thermal energy lost to the surroundings.

.....

.....

.....

..... [2]

- (b) The hot coffee loses thermal energy at a constant rate of 60 J/s to the surroundings and the optimum temperature of drinking the coffee is 55 °C.

Calculate the duration, in seconds, needed before the student can drink the coffee at its optimum temperature.

time taken = [3]

- 8 An optic fibre carries information in the form of waves. Fig. 8.1 below shows part of an optic fibre with a light ray passing through it.

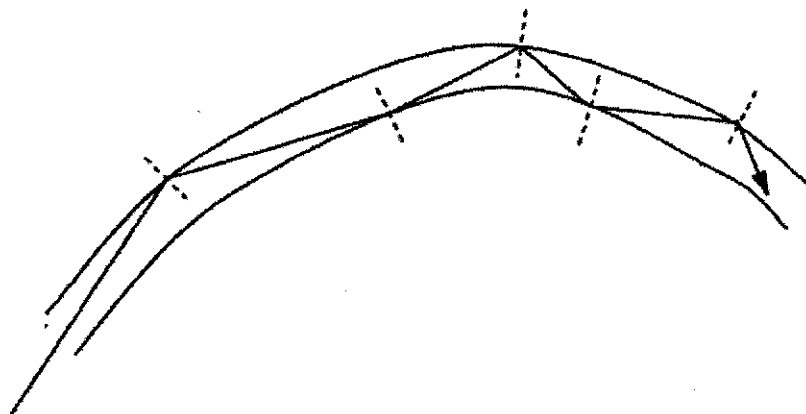

Fig. 8.1

- (a) Given that the angle of incidence of the light ray is 65° and the refractive index of the optic fibre is 1.2.
- (i) Calculate the critical angle of the optic fibre.

critical angle = [2]

- (ii) Explain why the light ray does not leave from the walls of the optic fibre.

.....

 [2]

[Turn over

- (b) The optic fibre is bent at a large angle such as the shape shown in Fig. 8.2.



Fig. 5.2

State and explain any changes, if any, to the travelling of the light ray.

.....

.....

.....

..... [2]

- (c) The optic fibre is now laid straight and is very thin such that the light rays almost travel in a straight line.

Calculate the speed of light in the straight optic fibre.

speed = [2]

- End of Section A -

Section B

Answer all the questions in this section.

Answer only one of two alternative questions in **Question 11**.

- 9 Some information as shown in Fig.9.1 is given by the manufacturer of an electric car for use in a town.

	with a load of 80 kg	with a load of 160 kg
maximum speed	10.9 m/s	10.9 m/s
initial acceleration	2.00 m/s ²	1.85 m/s ²

mass of car without any load	900 kg
furthest distance travelled by car at maximum speed without recharging	49 km
average power produced by battery at maximum speed	4.24 kW
Optimum power to fully recharge	4560 W

Fig 9.1

- (a) (i) When the load in the car doubles from 80 kg to 160 kg, the initial acceleration of the car decreases slightly.

Using the data from Fig. 9.1, explain why the acceleration decreases but does not decrease by half.

.....

 [2]

- (ii) Explain, in terms of the forces acting on the car and Newton's laws of motion, why the car has a maximum speed.

.....

 [2]

[Turn over

- (b) The car travels the furthest distance at the maximum speed without charging.

Calculate

- (i) the time taken,

time taken = [1]

- (ii) energy provided by the battery,

energy = [2]

- (iii) the minimum time taken to fully recharge the battery.

time taken = [1]

- (iv) State one assumption that you made in calculating (b)(iii).

.....

 [1]

- (c) Suggest one environmental advantage of using an electric car in a town.

.....

 [1]

- 10 There are three diving boards of different heights in a swimming pool for divers to dive as shown in Fig 10.1. Each level of diving board is connected to the level below by ladders. The height of each step of the ladder to level 1 is 15 cm while those to the levels 2 and 3 are 20 cm.

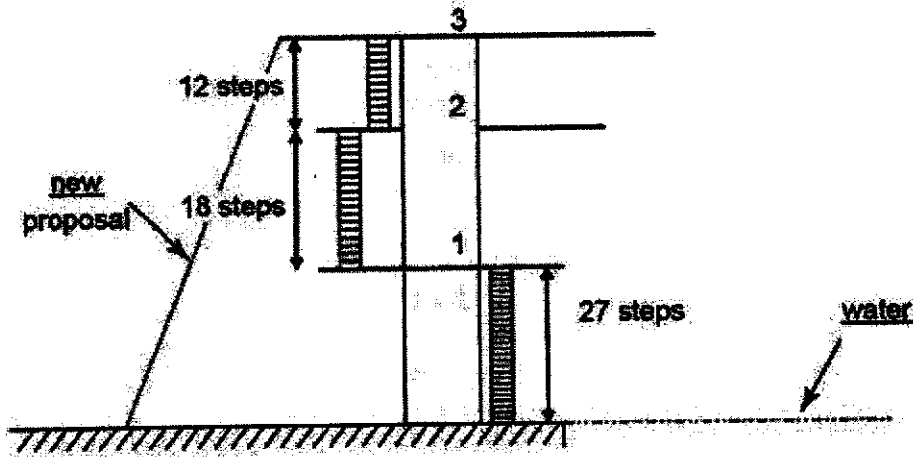

Fig 10.1

- (a) A diver of mass 47 kg climbs up the stairs from the ground.
Calculate the potential energy gained by him when he reaches level 3.

potential energy = [2]

- (b) Calculate the average power if he takes 35 s to climb up from ground level to level 3.

power = [2]

[Turn over

- (c) A man walks along level 1.

Explain if there is any work done by the weight of the man.

.....
.....
.....
..... [2]

- (d) A new construction plan is proposed to build a flight of stairs, that runs directly from the ground level to level 3. It allows divers to go directly from the ground level to level 3, instead of climbing up through levels 1 and 2.

Explain why the new proposal will **not** reduce the amount of potential energy needed to climb up to level 3.

.....
..... [1]

- (e) A diver at level 3 jumps up with an initial velocity of 4.4 m/s.

Calculate the maximum height he can reach above the water.

height = [3]

11 EITHER

Fig. 11.1 shows a cable car system for transporting passengers from station A to station B.

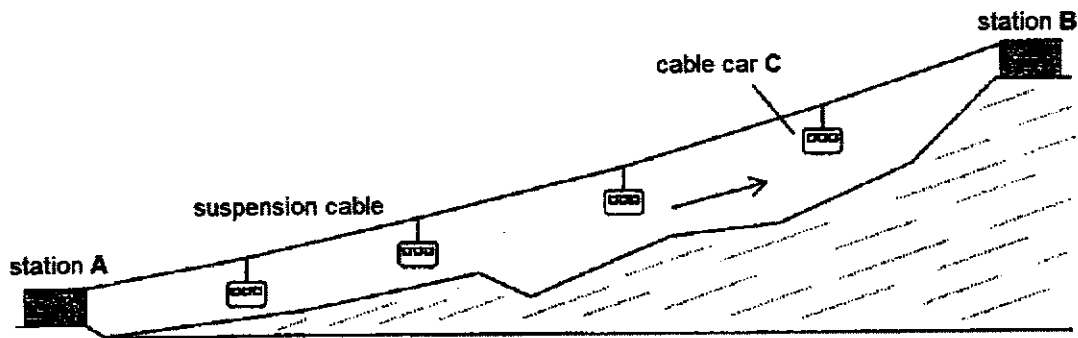

Fig. 11.1

The mass of the cable car C is 580 kg and the gravitational field strength is 10 N/kg.

(a) Calculate the weight of cable car C.

weight = [1]

[Turn over

- (b) The cable car is moving at a constant velocity towards the top of the hill. Fig. 10.2 shows cable car C suspended by the cable with tensions T_1 and T_2 .

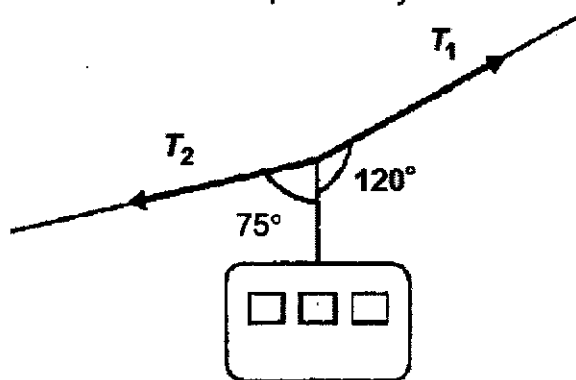

Fig. 11.2

By using a suitable scale, draw a vector diagram to determine T_1 and T_2

$$T_1 = \dots\dots\dots$$

$$T_2 = \dots\dots\dots [3]$$

- (c) Cable car C enters the station. At P, it moves with a constant velocity of 4.5 m/s. The cable car slows down with a constant deceleration after it passes X. The velocity is reduced to 0.5 m/s at Y, and it takes 8.0 s for the cable car to travel from X to Y. After Y, the cable car travels at constant velocity. This is shown in Fig. 10.3.

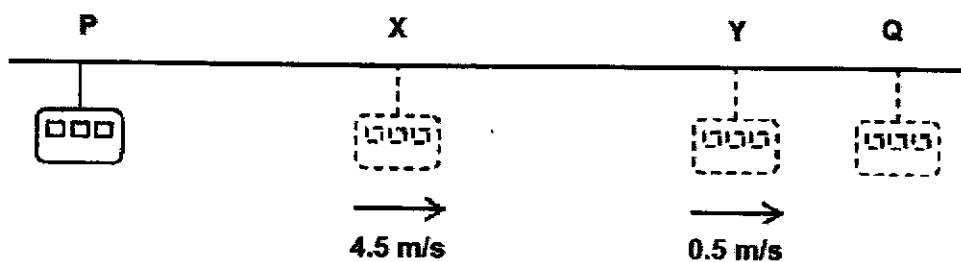

Fig. 11.3

- (i) On Fig. 10.4, sketch the velocity-time graph of the cable car for the journey between X and Q.

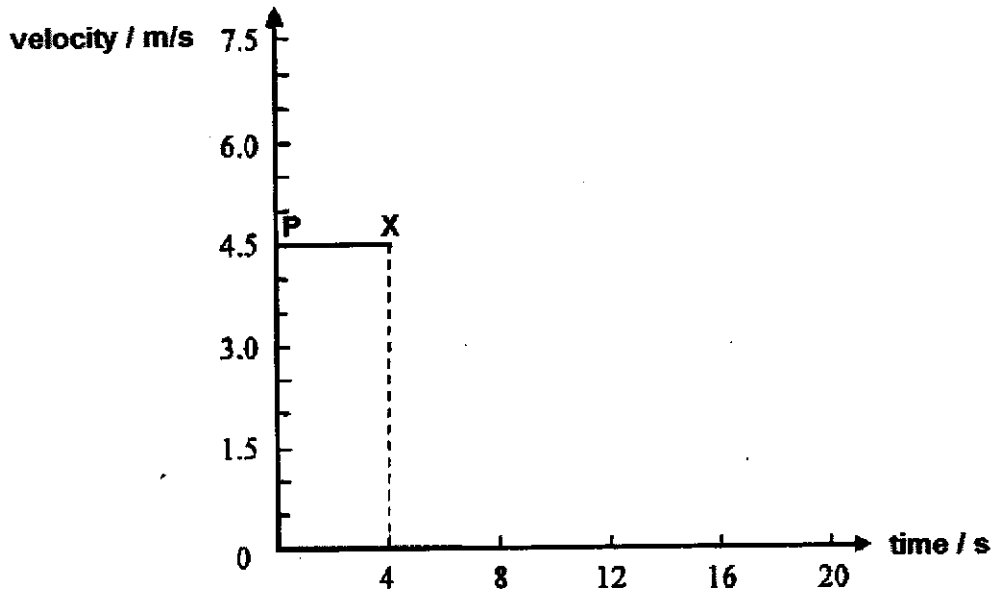

Fig. 11.4

[2]

- (ii) Determine the distance between X and Y.

distance = [2]

- (iii) Calculate the change in kinetic energy of cable car C from X to Y.

change in kinetic energy = [2]

[Turn over

11 OR

A laser produces a beam of red light.

- (a) Red light from the laser strikes one side of a glass prism at an angle of incidence i . The light refracts towards the normal as it enters the prism.

Fig. 11.5 shows the prism, the light and a screen.

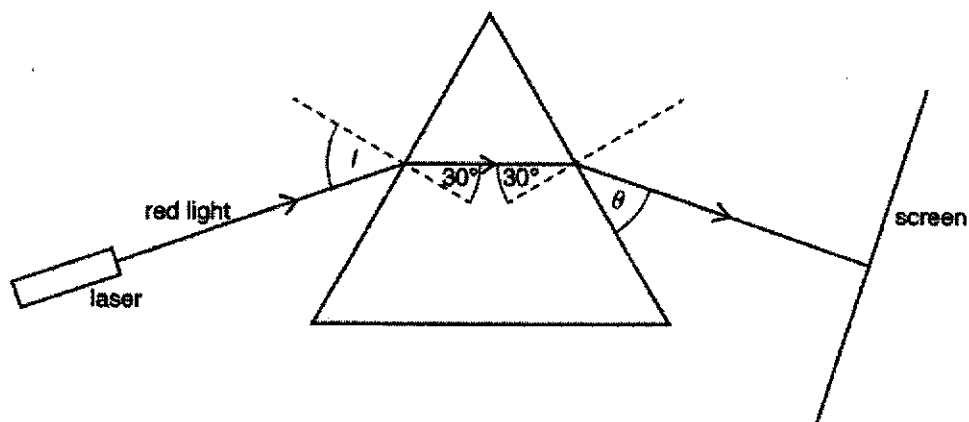

Fig. 11.5 (not to scale)

- (i) State what happens to the speed of light as it enters the glass.

..... [1]

- (ii) The refractive index of the glass is 1.5. The angle of refraction in the glass, where the light enters the prism, is 30° .

Calculate the angle of incidence i .

$$i = \text{.....} [2]$$

- (iii) The light then passes back into the air and strikes the front of the white screen, as shown in Fig. 11.5.

Calculate θ , the angle between the ray in air and the side of the prism.

$$\theta = \text{.....} [1]$$

- (b) The laser is replaced with a filament lamp and a slit, as shown in Fig. 11.6.

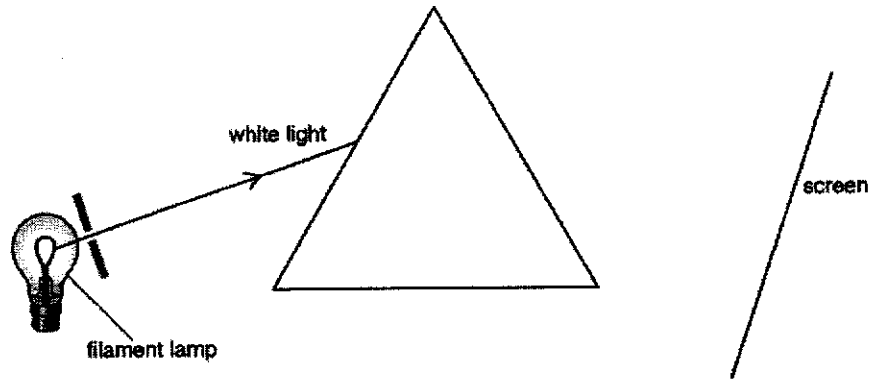

Fig. 11.6 (not to scale)

A ray of white light now strikes the prism.

- (i) On Fig. 11.6, draw what happens to the light as it passes through the prism and strikes the screen. [2]
- (ii) In addition to visible light, the filament lamp also emits some infra-red radiation. This infra-red radiation is able to pass through glass.

On the screen in Fig. 11.6, mark an X to indicate a place where infra-red radiation strikes the screen. [1]

- (c) Infra-red radiation is often detected by using a sensitive thermometer with a bulb that has been painted black.

Explain why the blackened bulb makes the thermometer a good detector of infrared radiation.

.....
 [1]

- (d) Explain the role played by infra-red radiation in intruder alarms.

.....

 [2]

----- End of Section B -----

----- End of Paper -----

Paper 1

D	A	B	D	C	C	D	C	B
D	D	A	A	A	D	A	D	D
C	B	A	D	D				

Paper 2

1(a)	Gravitational potential energy → kinetic energy → gravitational potential energy	[1]	Generally well answered.
(b)(c)		[1] [1]	(b) Marks awarded as long as students show 2 cycles. (c) Marks awarded when students show a longer time for X Many students could not do this question.
2	<p>When a force is applied on the brake pedal,</p> <ul style="list-style-type: none"> force exerted by the master piston over a small area produce a large pressure in the brake fluid in the master cylinder since pressure is equal to force per unit area. The pressure is transmitted evenly throughout the brake fluid to the slave cylinder. This then produces a force in the slave pistons to push the brake shoe against the brake drum. 	[1] [1] [1]	Most get at least 2 marks. Some mix up pressure and force and used the terms interchangeably. Some missed out the last part.

(a)(ii)	Oil is - non volatile / a liquid - cannot be compressed. This allow pressure to be transmitted evenly throughout the fluid from the master piston to the slave piston $P = F / A$ $= 140 / 2$ $= 70 \text{ N} / \text{cm}^2$ $F = PA$ $= 70 \times 2.8$ $= 196 \text{ N}$	[1]	Generally well answered.
(b)(i)		[1]	Most were able to answer this question but there were a handful who had no units or wrong units.
(b)(ii)		[1]	Some students multiplied the area by 2, some divided the area by 2. Fluid pressure at the slave piston is constant.
3(a)	Scalar quantities have magnitude only while vector quantities have both magnitude and direction.	[1]	Generally well answered.
(b)	Distance = 82 m	1m	Some students calculated the area under the graph.
(c)	0 s to 10 s: constant velocity 10 s to 20 s: zero velocity / stationary / not moving 20 s to 32 s: moving in opposite direction at constant velocity	[1] [1] [1]	Students were confused between s-t and v-t graph. Some were confused between uniform velocity and uniform acceleration. However, most were able to identify the object at rest for 10s to 20s.
4(a)(i)	No resultant force / net force OR Forces are balanced OR Forces in opposite directions are equal OR Forces cancel	[1]	Most were able to identify the condition.
(ii)	no resultant / net moment / torque / turning effect OR (Sum of) clockwise moments = (sum of) anticlockwise moments	[1]	Badly answered. Most were not able to link it to moments. "equilibrium" not accepted.
(b)(i)	Moment = Fd $= 24 \times 0.4$ OR $24\,000 \times 0.4$ $= 9.6 \text{ kN m}$ OR $= 9600 \text{ Nm}$	[1]	Some were confused with the values to use.
(ii)	$T_1 \times 1.6 = 9.6$ OR $= 9600 \text{ Nm}$ $T_1 = 6 \text{ kN}$ OR $T_1 = 6000 \text{ N}$	[1] [1]	Many used the wrong distance in the calculation. Students do not seem to know where is the pivot.

(iii)	$T_1 + T_2 = 24\ 000$ $6000 + T_2 = 24\ 000$ $T_2 = 18\ 000\ \text{N}$ <p>OR</p> $T_1 + T_2 = 24$ $6.0 + T_2 = 24$ $T_2 = 18\ \text{kN [1]}$ <p>OR</p> $T_2 \times 0.40 = 6000 \times 0.40$ $T_2 = 18\ 000\ \text{N [1]}$ <p>OR</p> $T_2 \times 0.40 = 6.0 \times 0.40$ $T_2 = 18\ \text{kN [1]}$	[1]	ECF awarded. ECF awarded. Many do not seem to understand the question.
5(a)	$P_o = h\rho g$ $= 0.75 (13.6 \times 10^3)(10)$ $= 102000\ \text{Pa}$	[1] [1]	Students generally know the formula but do not seem to know what the question required.
(b)	$P_o = \text{pressure due to } 0.65\ \text{m of Hg} + P_{\text{air}}$ $102000 = 0.65 (13.6 \times 10^3)(10) + P_{\text{air}}$ $P_{\text{air}} = 13600\ \text{Pa}$	[1] [1]	Not many understood the question. Some added the atmospheric pressure to the Hg pressure instead of subtracting.
(c)	<p>Volume of air above mercury in Q decreases. This increases the pressure of air.</p> <p>Since atmospheric pressure remains constant, the pressure due to the Hg in Q has to decrease.</p>	[1] [1]	Some students do not seem to understand the question. Accept "air particles exert pressure on mercury", causing the mercury level to decrease.
6(a)	<p>During this process, energy from the surrounding is used to break/overcome the intermolecular bonds between the particles,</p> <p>no energy is used to increase kinetic energy so kinetic energy of the particles remains the same during this process thus there is no temperature drop.</p> <p>OR</p>	[1] [1]	Most were able to state the effect on the intermolecular bonds. However, many did not link it to the internal energies. Mark awarded for either the potential or kinetic energy explained.

	Increase in energy is converted to <u>internal potential energy</u> .		A handful gave general answers, not using the Kinetic model. Not accepted.
(b)	The particles <u>move faster</u> as temperature increases and they also become <u>farther apart</u> from each other.	[1] [1]	Many students described the particles sliding past one another but did not show the changes as temperature increases. Some only wrote one out of the 2 points.
(c)	Internal kinetic energy remains the same and internal potential energy increases.	[1]	Very few managed to answer this question completely. Some just mentioned about the internal energy increases, without reference to the kinetic and potential energies.
7(a)	White colour is a poor radiator of heat. Thus it reduces heat loss from the cup to the surrounding air through radiation. The lid prevents the hot air from escaping. Thus it reduces heat loss from the cup to the surrounding air by convection. Cork traps air which is a poor conductor of heat. Thus it reduces heat loss from the cup to the surrounding air by conduction.	[1] [1] [1] [Any 2]	Some students link colour and conduction together. Accept "lid prevents heat lost to the surrounding by evaporation"
(b)	Energy loss by coffee = $mc\Delta\theta$ = $0.35 \times 4200 \times 40$ = 58800J time = $58800 \div 60$ = 980s	[1] [1] [1]	Generally well answered.
8(a)(i)	$\sin c = 1/n$ = $1/1.2$ c = 56.4°	[1] [1]	Most students were able to get the right answer.
(ii)	Since the angle of incidence of 65° is greater than the critical angle of the optic fibre which is 56.4° and the light ray travels from the optically denser medium within the fibre to optically less medium outside the fibre, the light ray undergoes total internal reflection . Therefore, the light ray reflects internally within the optic fibre.	[1] [1]	Do note that 56.4° is round to 3 sf and not 1 dp . Most students state the only 1 of the conditions of total internal reflection. For students who mentioned about the travelling of light ray from optically denser medium within the fibre

			to optically less medium outside the fibre, it is important to include "optically" as optically denser medium is not the same as denser medium.
(b)	When the optic fibre is bent at a large angle, the angle of incidence on the walls of the optic fibre will decrease. If the angle of incidence decreases to below the critical angle of 56° , the light ray will not be reflected internally / undergo total internal reflection but will refract out from the walls of the optic fibre.	[1] [1]	The context of the question is about total internal reflection in fibre optics. Not all students recognizes that the bending of fibre optics can results in a smaller angler of incidence. Hence, resulting in light refracting out.
(c)	$n = c / v$ $v = (3.0 \times 10^8) / 1.2$ $v = 2.5 \times 10^8 \text{ m/s}$	[1] [1]	Many students did not know the formula. This is meant to be an easy question.
9(a)(i)	The mass of the car without load is 900kg. When the car is loaded with 80kg, it only increases the total mass of the car by 8.89%. When the car is loaded with 160kg, it only increases the total mass of the car by 17.8%. Hence the additional mass will only decreases its acceleration slightly due to the small increase in percentage of the mass.	[2]	Question is answered poorly. Question requires students to use the DATA and explain that acceleration DECREASES but not by HALF when LOAD increases from 80 kg to 160 kg.
(a)(ii)	There are two main resistive forces acting on the car, namely the air resistance and friction that affect the net force of the car. As the car continue to move forward powered by the engine, the air resistance continue to increase as the speed increases till a point where the forward thrust of the car powered by the engine equals to the resistive forces. The net force become zero, the car no longer accelerates and hence it will start to move at constant speed which is the maximum speed.	[2]	Question is answered poorly. Question requires students to identify FORCES acting on car and USES one of the Newton's law to explain WHY car has a MAXIMUM SPEED. A few students wrongly mentioned resultant force IS maximum speed.
(b)(i)	Time taken = maximum distance / maximum speed = $49 \times 1000 / 10.9$ = 4495		Generally ok

	$= 4500 \text{ s (3sf)}$	[1]	
(b)(ii)	$E = Pt$ $= 4.24 \times 1000 \times 4495$ $= 1.91 \times 10^7 \text{ J (3sf)}$	[1]	Generally ok. it was disappointing to have students to use the wrong formula. $P = Et$ Or to use wrong SI unit for Power Or use wrong symbol for formula
(b)(iii)	$P = VI$ $= 48 \times 95 = 4560 \text{ W}$ $t = E / P$ $= 19.1 \times 10^6 / 4560$ $= 4188.6$ $= 4190 \text{ s (3sf)}$	[1] 1	Generally ok.
(b)(iv)	Assuming no power loss during charging process	[1]	Generally ok.
(c)	No exhaust gases / pollutants given out due to combustion, hence it does not pollute the air.	[1]	Students seems to think that electric car still produces carbon or greenhouse gases, but of a smaller quantity.
10(a)	$E_P = mgh$ $= 47 \times 10 \times (27 \times 0.15 + 18 \times 0.2 + 12 \times 0.2)$ $= 47 \times 10 \times 10.05 = 4.72 \text{ kJ or } 4720 \text{ J (3sf)}$	[1] [1]	Generally ok. However, a group of students wrongly calculated the height.
(b)	$\text{Power} = \text{Energy} / \text{time}$ $= 4.73 \times 10^3 / 35$ $= 135 \text{ W (3sf)}$	[1] [1]	Generally ok.
(c)	No work is done by the weight of the man when he is walking along level 1. Because his weight and his direction of displacement are perpendicular to each other.	[1] [1]	Generally ok.

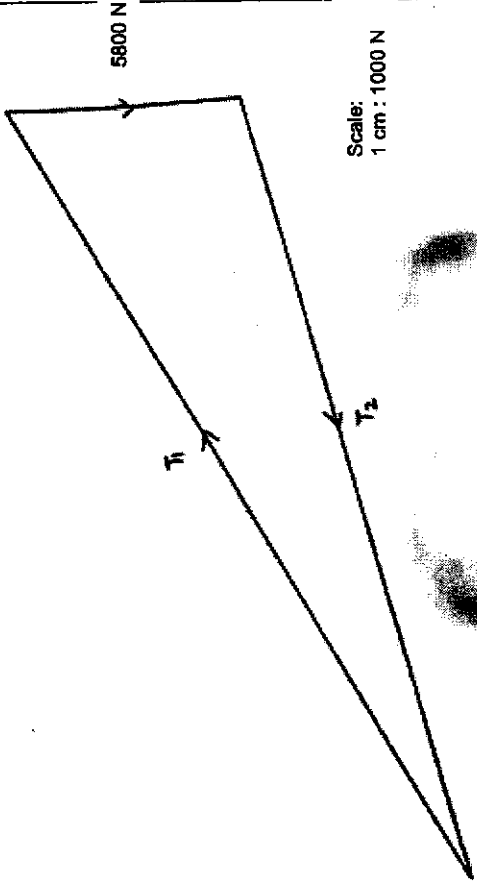
(d)	<p>The work done against gravity is independent of the path of the displacement. The potential energy needed depends only on the height of level 3 from the ground.</p>	[1]	Generally ok.
(e)	<p>Gain in GPE = loss in KE $47 \times 10 \times h = \frac{1}{2} \times 47 \times 4.42$ $h = 0.968 \text{ m}$ Max. height = $10.05 + 0.968$ $= 11.0 \text{ m}$</p>	<p>[1] [1] [1]</p>	<p>Most students failed to add the height of 11 m. Some students did not give clear understanding of Gain in GPE = loss in KE</p>
10 E	<p>(a) $W = mg$ $= (580)(10)$ $= 5800 \text{ N}$</p> <p>(b)</p>  <p>correct shape of vector diagram and arrows T1 = 22000 N (accept 20000 N to 24000 N) T2 = 20000 N (accept 18000 N to 22000 N)</p>	<p>[1] [1] [1]</p>	<p>Generally ok. Only a small group of students answered the question correctly.</p>

(c)	<p>XY correctly drawn YQ correctly drawn</p>	[1] [1]	Generally ok.
(ii)	<p>distance = area under v-t graph $= \frac{1}{2} (4.5 + 0.5)(8)$ $= 20 \text{ m}$</p>	[1] [1]	Generally ok.
	<p>change in KE = $\frac{1}{2} mv^2 - \frac{1}{2} mv^2$ $= \frac{1}{2} (580)(4.5)^2 - \frac{1}{2} (580)(0.5)^2$ $= 5800 \text{ J}$</p>	[1] [1]	Please note that $(4.5 - 0.5)^2$ is not the same as $4.5^2 - 0.5^2$

10 OR		
(a) (i)	decreases	[1] Generally ok.
(ii)	$\sin(i) = n \sin(r)$ or $1.5 \sin(30^\circ)$ or 0.75 $i = 49^\circ$	[1] [1] Generally ok.
(iii)	41°	[1] Generally ok.
(b) (i)	Two refracted rays within prism Two emergent rays outside prism (Any 2 correct rays, 1 m)	[1] [1] Most students did not know how refraction of light takes place in prism
(ii)	1 X marked above red	[1]

(c)	2 it is / black surfaces are good absorbers (of IR radiation)	[1]	Generally ok	
(d)	intruder / human being emits IR intruder warm or IR detected OR	Any pair, 2m	Please use "radiation" instead of "heat"	
	IR beam broken does not reach detector OR		Generally ok	
	IR reflected change detected			

