

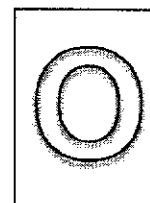

## CANBERRA SECONDARY SCHOOL



## 2019 Semestral Examination 2

## Secondary Three Express

**BIOLOGY**

6093/01

10 Oct 2019

1 hour

0820 - 0920 h

Name: \_\_\_\_\_ ( ) Class: \_\_\_\_\_

**READ THESE INSTRUCTIONS FIRST**

Write your full name, class and index number in the spaces provided on the question paper and on the OTAS sheet.

Do not use staples, paper clips, highlighters, and glue or correction fluid.

There are forty questions in this paper. Answer all questions. For each question there are four possible answers, A, B, C and D.

Choose the one you consider correct and record your choice in soft pencil on the separate OTAS Sheet.

You are allowed to use calculator for this paper.  
Any rough working should be done in this booklet.

	Marks Awarded	Max Marks
Total		40

This question paper consists of 20 printed pages including the cover page.

**Setter: Ms Michelle Tham**

1. Which organelle is **not** correctly paired with its cellular function?

	organelle	function
A	endoplasmic reticulum	stores carbohydrate
B	Golgi body	releases vesicles
C	mitochondrion	releases energy
D	ribosome	joins amino acids together

2. The diagram shows the structure of a root.

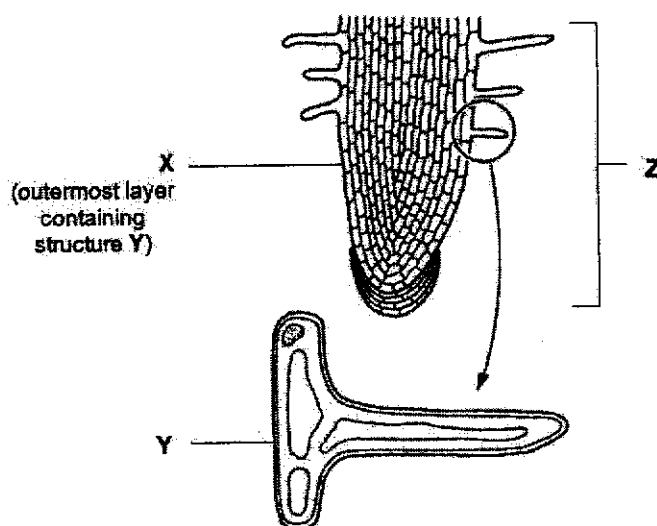

Which of the following correctly identifies a cell, tissue and organ?

	cell	tissue	organ
A	X	Y	Z
B	X	Z	Y
C	Y	X	Z
D	Y	Z	X

3. Some processes which occur in flowering plants are listed.

- I ion uptake by roots hairs
- II water uptake by root hairs
- III ion movement up the xylem in the stem
- IV water vapour loss through stomata in leaves

Which processes involve the cell surface membrane?

- A I only
- B II only
- C I and II
- D III and IV

4. The diagram below shows the structure of a plant cell as seen using an electron microscope.

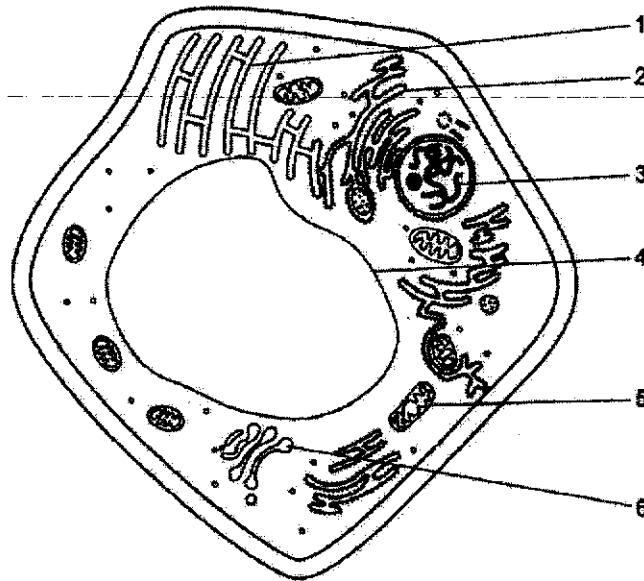

Which structures are involved in the process of enzyme synthesis within this cell?

- A 1, 2, 4, 5 and 6  
 B 1, 3 and 6  
 C 2, 3, 5 and 6  
 D 3, 4 and 5
5. The diagram shows two solutions that are separated by a partially permeable membrane.

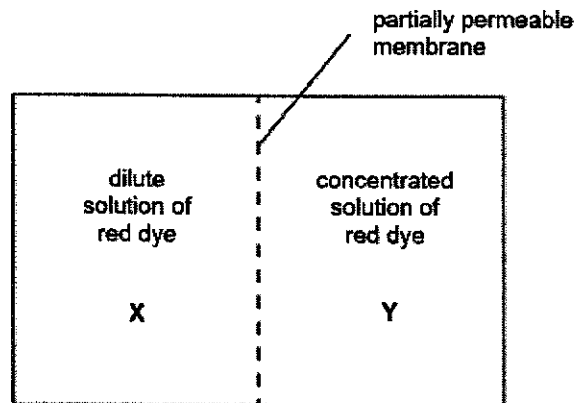

Which direction will most of the red dye molecules move in relation to the concentration gradient?

- A from X to Y against the concentration gradient  
 B from X to Y down the concentration gradient  
 C from Y to X against the concentration gradient  
 D from Y to X down the concentration gradient

6. The diagram shows an experiment on an uncooked potato.

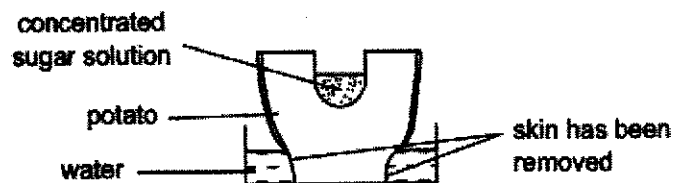

Which diagram shows the result after 24 hours?

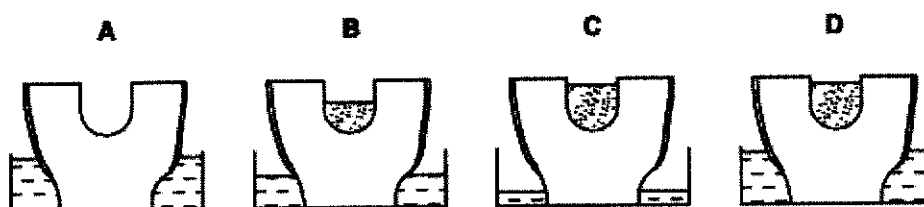

7. The diagram shows three plant cells labelled P, Q and R. The arrows show the direction of net movement of water molecules by osmosis.

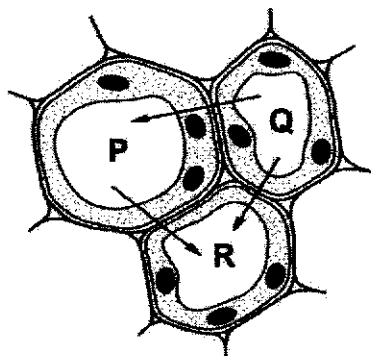

What is the correct order of salt concentration in the cells, from the highest to the lowest?

	highest	middle	lowest
A	P	Q	R
B	P	R	Q
C	Q	P	R
D	R	P	Q

8. A plant cell was treated with the enzyme cellulase, which acts on cellulose. The treated plant cell was then left in a petri dish filled with distilled water for 30 minutes.

What would happen to the plant cell after 30 minutes?

- A The plant cell would become turgid.  
 B The plant cell would burst.  
 C The plant cell would become plasmolysed.  
 D The plant cell would become flaccid.
9. The graph shows the relative concentrations of different ions inside and outside of an animal cell.

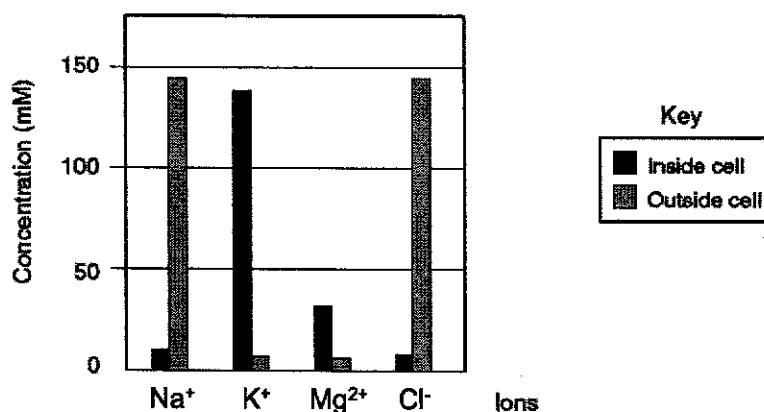

Which process is directly responsible for the net movement of K<sup>+</sup> and Mg<sup>2+</sup> ions into the animal cell?

- A diffusion  
 B osmosis  
 C absorption  
 D active transport
10. Four food tests were carried out on an unknown sample of food. The results of the tests are shown in the table below.

food test	result
Benedict's test	blue solution
biuret test	violet solution
ethanol emulsion test	white emulsion
iodine test	brown solution

Which of the following could be the food sample tested?

- A apple  
 B egg  
 C oil  
 D potato

11. The graph shows changing energy levels during a reaction, with and without the presence of the enzymes specific to this reaction.

What is the activation energy of the reaction with the enzyme?

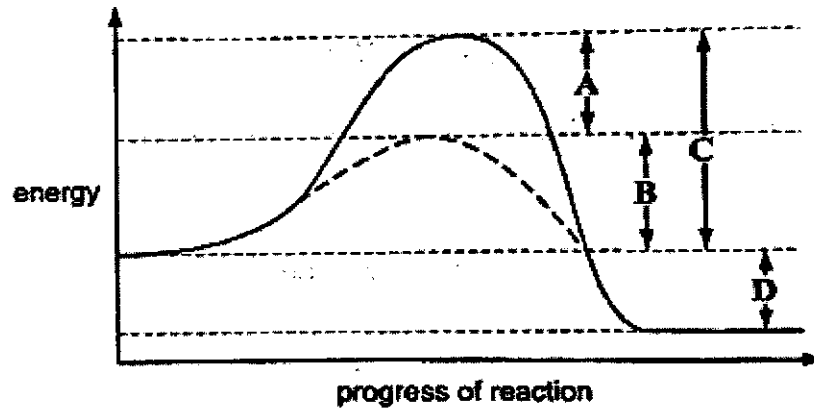

12. A quantity of an enzyme was added to a quantity of its substrate. The graphs show the changes in concentration of the enzyme, substrate, enzyme-substrate complex and product over time.

Which graph shows the change in the concentration of the enzyme-substrate complex?

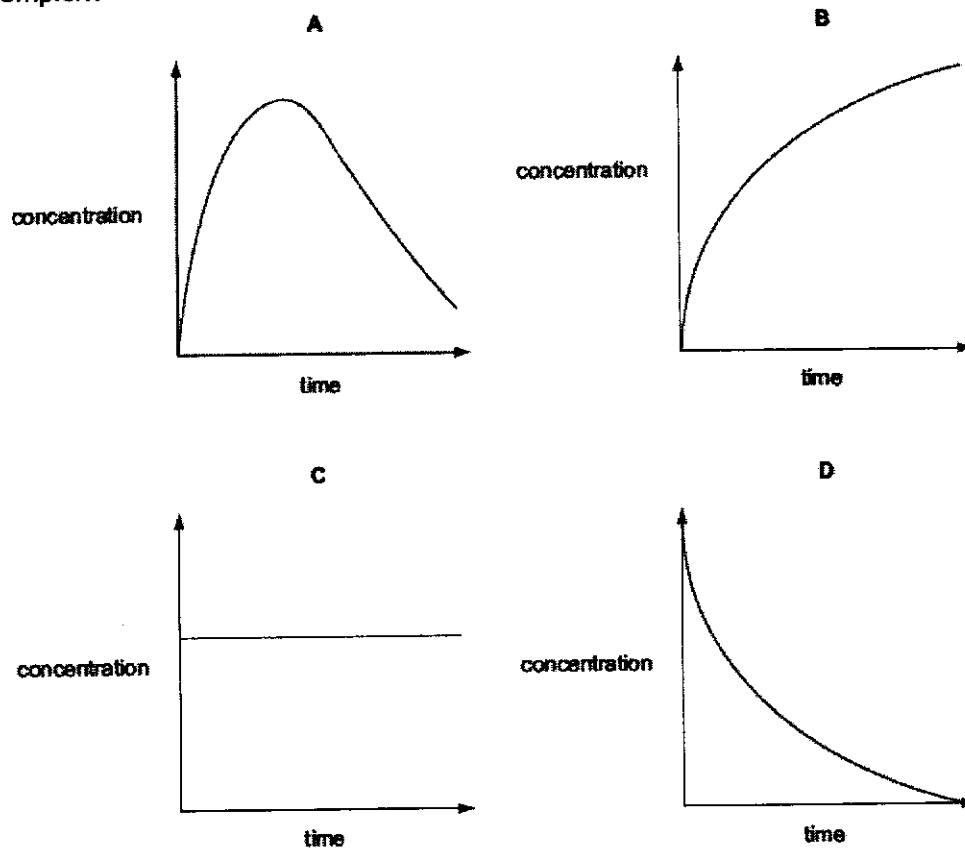

13. The graph shows the effect of various factors on the rate of starch digestion.

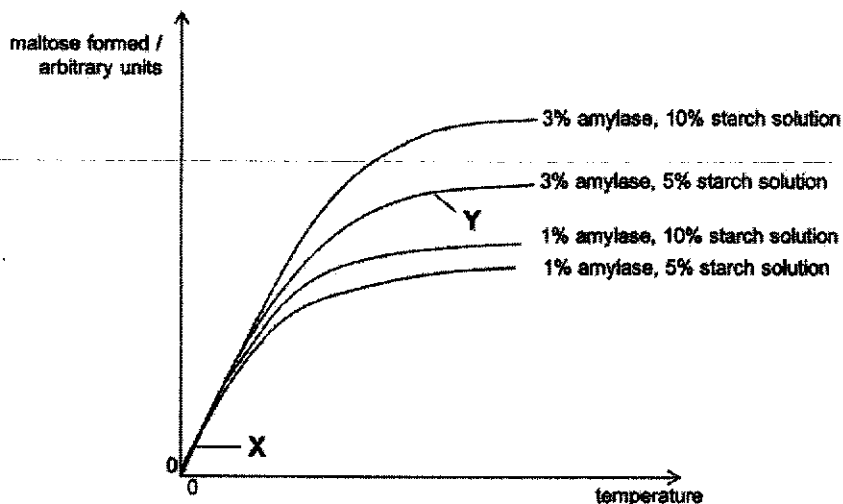

Which factors are limiting at X and at Y?

	X	Y
A	substrate concentration	enzyme concentration
B	enzyme concentration	substrate concentration
C	temperature	enzyme concentration
D	temperature	substrate concentration

14. Which graph shows the rate of enzymatic reaction when a hot mixture of starch and salivary amylase is cooled down from 100 °C to 0 °C over 30 minutes?

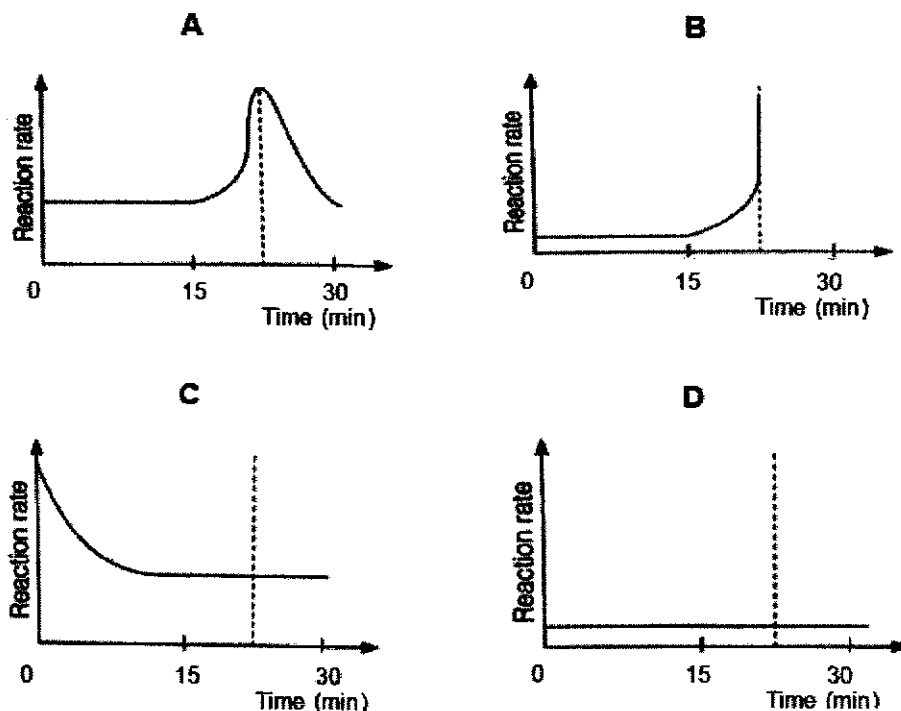

15. Which section of the diagram represents the effects of excessive consumption of alcohol?

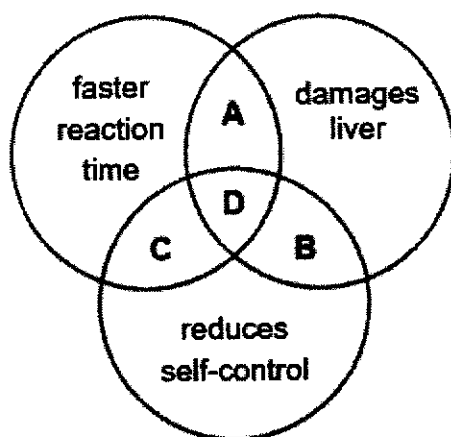

16. The diagram below shows three different types of food molecules when ingested.

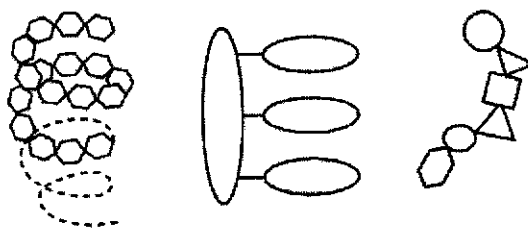

Which one of the following best shows how these molecules look like after three hours in the stomach?

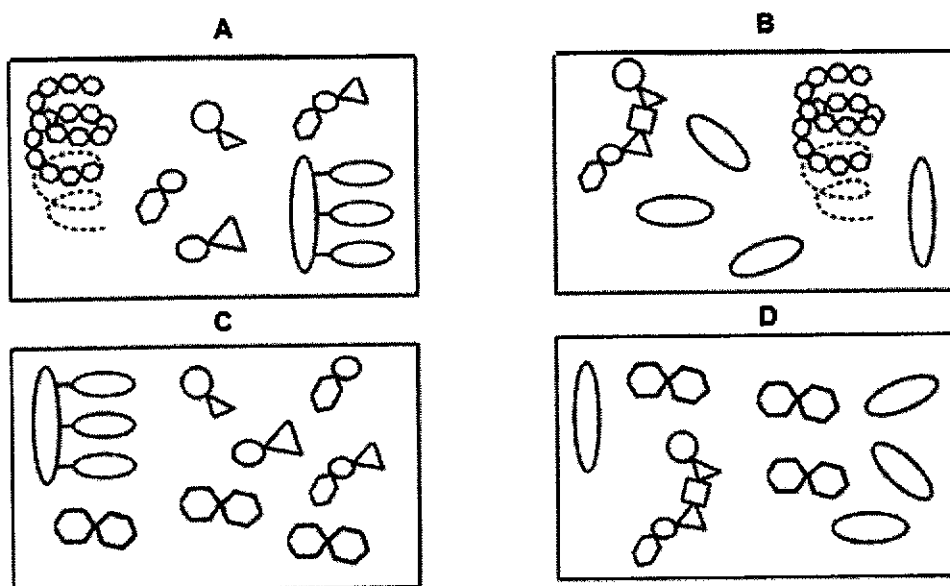



17. Gallstones can cause a painful blockage of the bile duct, stopping bile from leaving the gall bladder. Bile pigments escape into the blood and tissue, causing a yellowing of the skin.

Which of the following foods should patients suffering from this blockage avoid eating?

- A fried chicken and cake
  - B cereals and beans
  - C noodles in soup
  - D boiled vegetables and steamed fish
18. In which part of the alimentary canal does most absorption of water take place?
- A rectum
  - B stomach
  - C small intestine
  - D large intestine
19. The diagram shows a cross-section of a leaf. Which layers of cells would turn blue-black in an iodine test after several hours of sunlight?

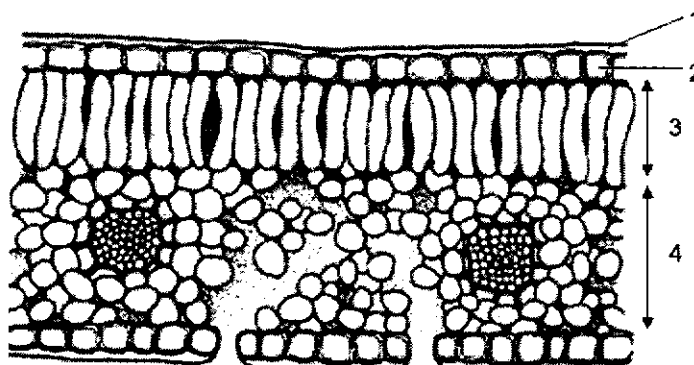

- A 1 and 2
- B 2 and 3
- C 3 and 4
- D 2 and 4

20. The diagram shows a control set-up to investigate the need for carbon dioxide in photosynthesis.

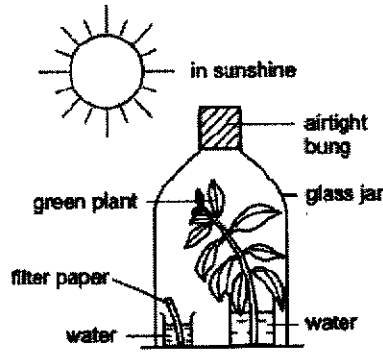

Which diagram shows the experimental set-up?

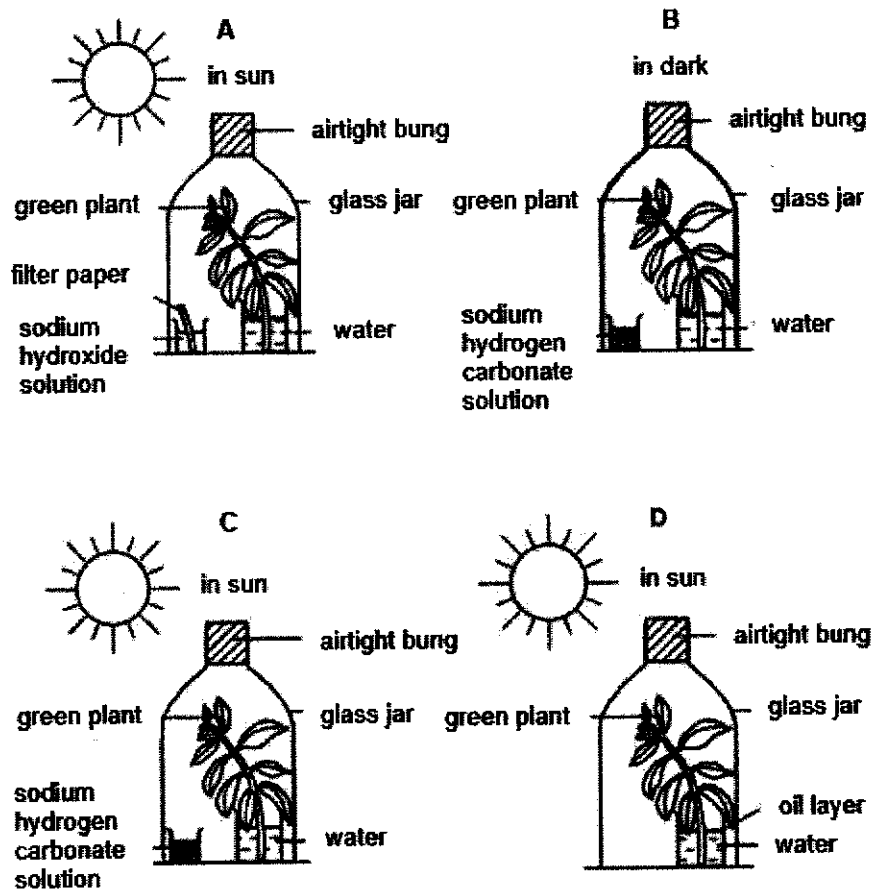

21. The following graphs show how the rate of photosynthesis is affected by two different conditions.

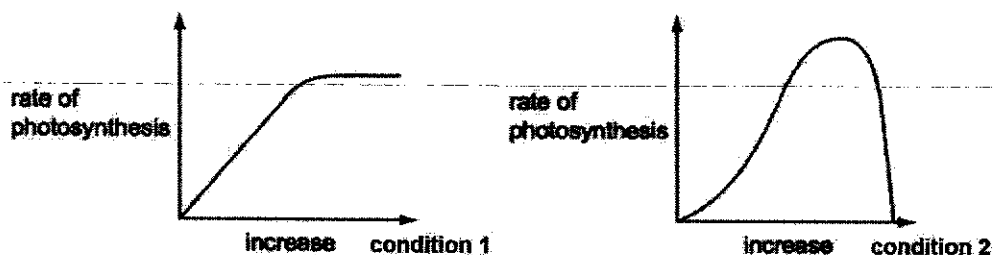

What are the conditions that are being altered?

	condition 1	condition 2
A	light intensity	temperature
B	temperature	pH
C	pH	CO <sub>2</sub> concentration
D	CO <sub>2</sub> concentration	light intensity

22. The graph shows the concentration of oxygen in the air spaces of a green leaf of a plant during a 12-hour period.

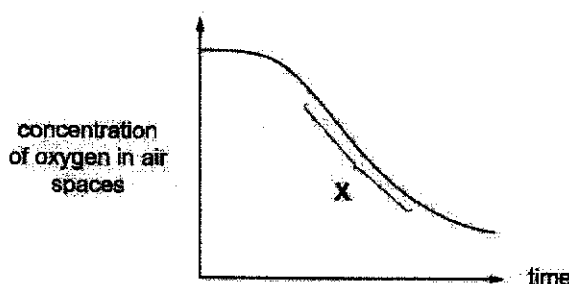

Which statement about carbon dioxide in the air spaces during time X is correct?

- A Carbon dioxide is being produced because the rate of photosynthesis is greater than the rate of respiration.
- B Carbon dioxide is being produced because the rate of respiration is greater than the rate of photosynthesis.
- C Carbon dioxide is being used because the rate of photosynthesis is greater than the rate of respiration.
- D Carbon dioxide is being used because the rate of respiration is greater than the rate of photosynthesis.

23. A plant is exposed to different environmental conditions. Which set of conditions would cause the plant to wilt the most?

	light intensity / lux	temperature / °C	relative humidity / %
<b>A</b>	150	15.0	70.0
<b>B</b>	250	35.0	60.0
<b>C</b>	400	15.0	50.0
<b>D</b>	800	35.0	30.0

24. The diagrams represent some plant cells seen in a section of a stem.

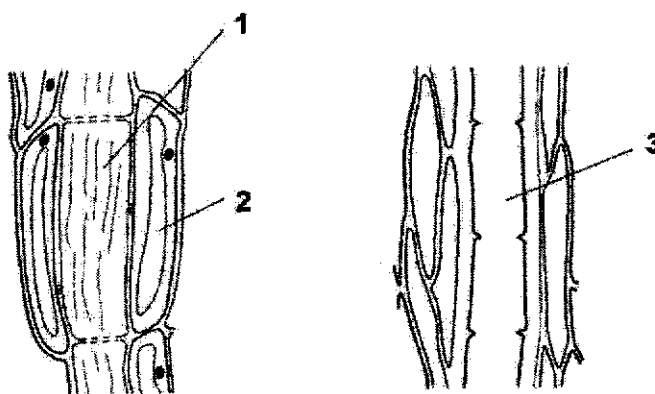

Which cells have the function shown?

	1	2	3
<b>A</b>	transport of sucrose	transport of water	transport of amino acids
<b>B</b>	transport of water	supply of energy to surrounding cells	support of young stem
<b>C</b>	transport of amino acids	supply of energy to surrounding cells	support of young stem
<b>D</b>	support of young stem	transport of water	transport of sucrose

25. The diagrams show an experiment on transpiration. Four leaves of the same species are balanced on two drinking straws. One or both sides of the leaves are covered in grease. Any difference in mass causes the heavier end to be lower.

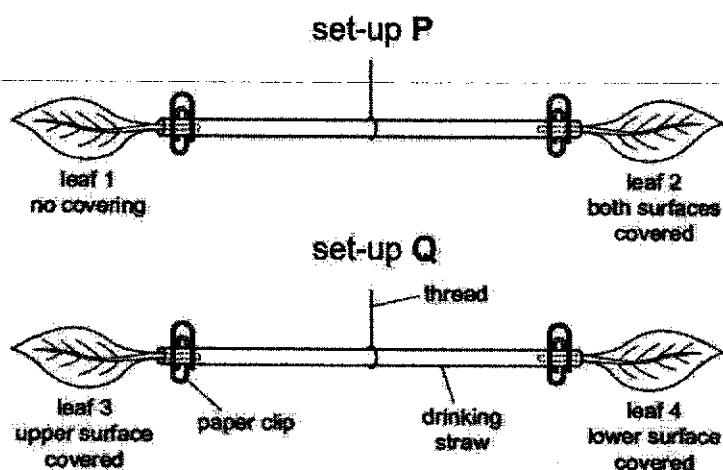

At the start of the experiment, the straws were positioned so that the leaves were level. Which leaves will be lower after an hour?

	set-up P	set-up Q
A	1	3
B	1	4
C	2	3
D	2	4

26. The diagram shows an insect using its piercing mouth part to obtain sugars from a plant tissue.

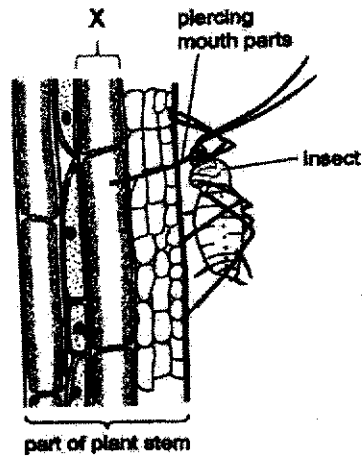

Cross-sections of the plant leaf and stem are shown below.  
Which numbered parts correspond to the plant tissue X?

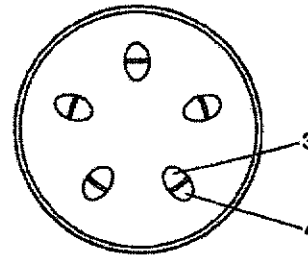
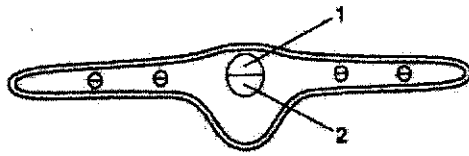

- A 1 and 3  
B 1 and 4  
C 2 and 3  
D 2 and 4
27. The table shows the blood groups of four people and the type of blood each received in a transfusion.

	blood group under ABO system	blood type received in transfusion
W	A	O
X	B	AB
Y	AB	O
Z	O	AB

Which two people are at risk from agglutination?

- A W and X  
B X and Y  
C X and Z  
D Z and W

28. Which of the following is not found in the blood plasma?

- A ammonia
- B oxygen
- C hormones
- D urea

29. The diagram shows a type of cell found in blood.



Which of the following is correct?

	type of cell	process involved in
A	red blood cell	blood clotting
B	lymphocyte	produce antibodies
C	phagocyte	phagocytosis
D	platelet	produce hormones

30. A diploid organism has 3 pairs of homologous chromosomes.

Which correctly describes the number of chromosomes present at each stage of cell division in each nucleus?

	stage of cell division	number of chromosomes
A	prophase I	12
B	prophase I	3
C	prophase II	6
D	prophase II	3

31. The diagram show a cell at four different stages of mitosis.

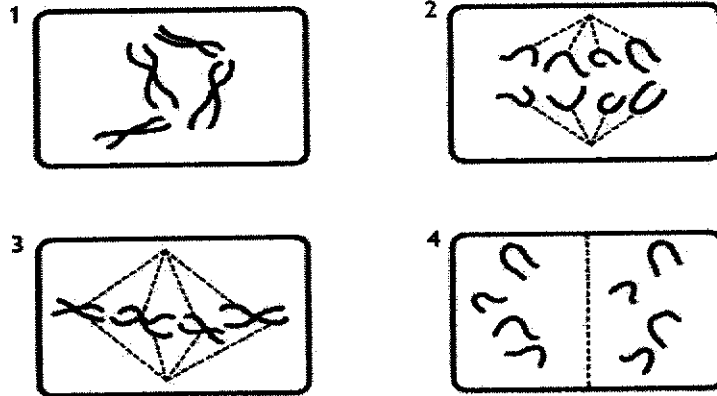

Which of the following shows the correct order of the stages of mitosis?

- A 1 → 3 → 2 → 4
- B 2 → 3 → 4 → 1
- C 3 → 2 → 1 → 4
- D 4 → 1 → 2 → 3

32. The diagram shows anaphase I of meiosis.

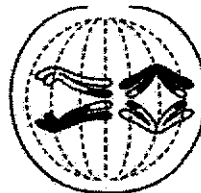

Which option shows metaphase II as meiosis continues in this cell?

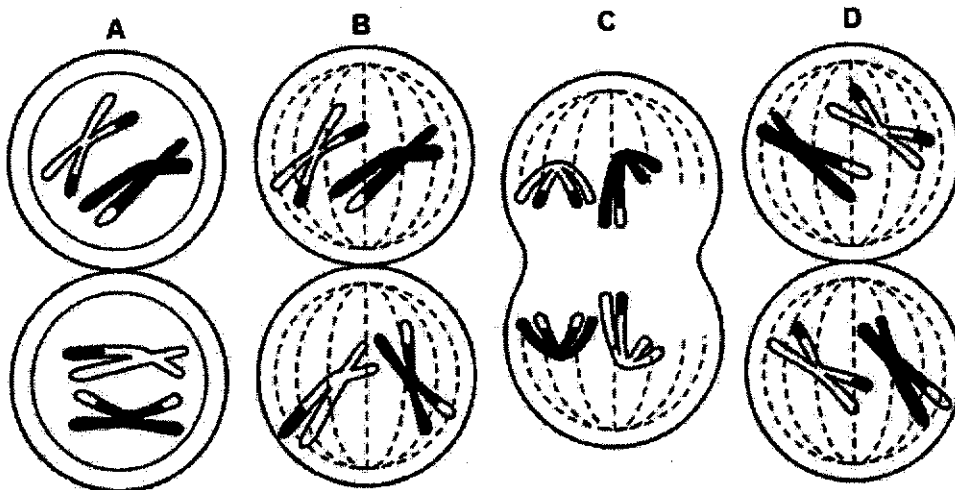



33. The bar chart shows the changes in the DNA content of a cell during the various stages of meiosis.

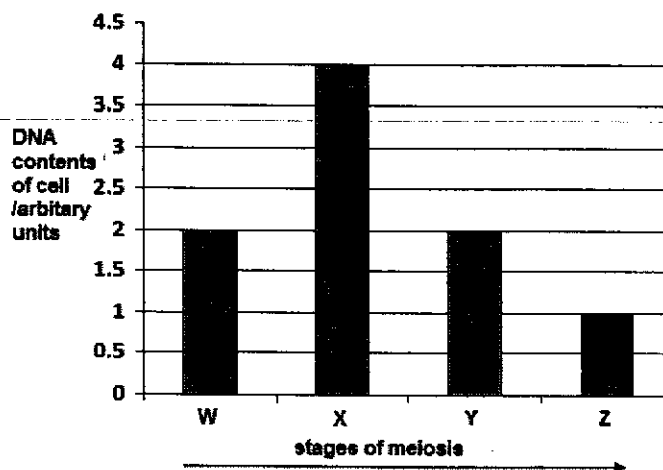

When did the homologous chromosomes separate?

- A between stages X and Y
  - B between stages W and X
  - C between stages Y and Z
  - D before the start of stage W
34. A sample of DNA contained 35.2% of nucleotides with the base adenine. What is the percentage of guanine in the DNA sample?
- A 14.8%
  - B 35.2%
  - C 50.0%
  - D 75.5%

35. Which is the correct arrangement for the components in a nucleotide?

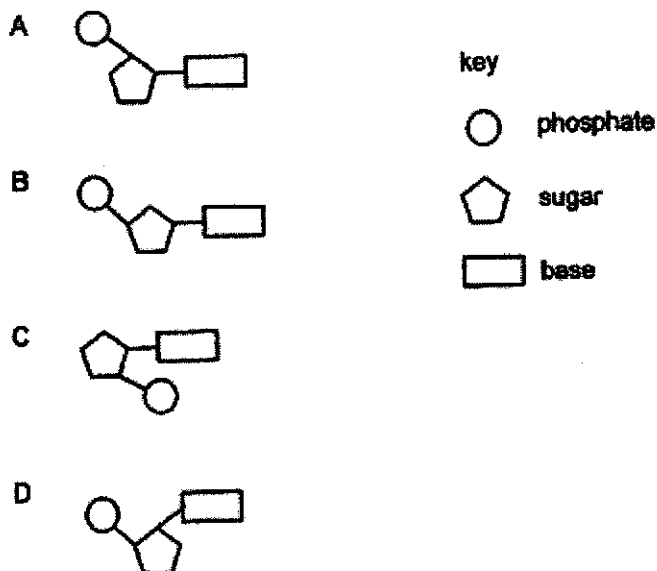

36. The table shows some amino acids and their corresponding mRNA codons.

amino acid	mRNA triplet (codon)
phenylalanine	UUU
leucine	CUU
valine	GUC
serine	UCC
cysteine	UGC
alanine	GCU

Which DNA sequence of the template strand would be needed to produce the polypeptide sequence alanine – leucine – valine – phenylalanine?

- A CGA GAA CAG AAA
- B CGA GAA CAG TTT
- C GCA CTT GTC AAA
- D GCA CTT GTC TTT

37. A couple has three children. The table shows some of the children's characteristics.

child	sex	blood group	sickle-cell / normal
1	male	B	sickle-cell
2	female	AB	normal
3	male	O	normal

What do the characteristics show?

- A continuous variation only  
 B discontinuous variation only  
 C both continuous and discontinuous variation  
 D neither continuous nor discontinuous variation
38. The family tree shows the inheritance of a condition caused by a recessive allele, *r*.

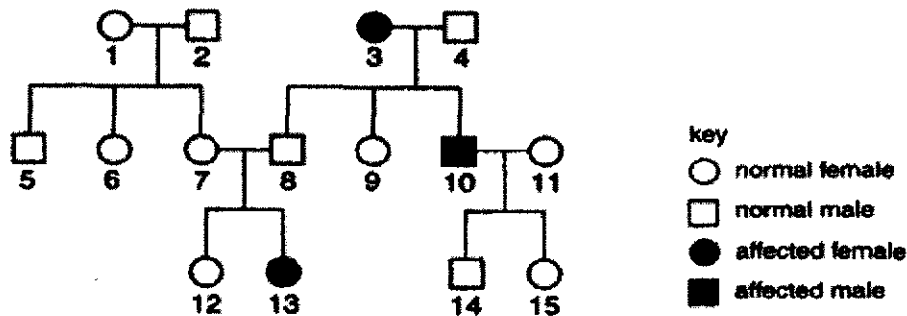

Which females are certain to have genotype  $Rr$ ?

- A 1, 6 and 7  
 B 6, 7 and 11  
 C 7, 9 and 15  
 D 9, 11 and 12
39. Genetic cross of pure-bred red flowers with pure-bred white flowers resulted in  $F_1$  offspring that all had pink flowers. When the  $F_1$  plants were self-pollinated, the resulting  $F_2$  generation plants had a phenotypic ratio of 1 red: 2 pink: 1 white.

What is the most likely explanation for this?

- A Pink flowers are the result of the blending of red and white genotypes.  
 B Flower colours are affected by more than two genes.  
 C Heterozygous plants have a different phenotype from the pure-bred plants due to co-dominance.  
 D Mutation has occurred in the genes.

40. A man of genotype  $I^A I^O$  and a woman of genotype  $I^B I^O$  have a child.

What is the chance of the child having the same blood group as one of the parents?

- A 0%
- B 25%
- C 50%
- D 75%

**-- End of Paper --**



# CANBERRA SECONDARY SCHOOL

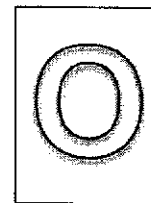

## 2019 Semestral Assessment 2

### Secondary Three Express

**BIOLOGY**  
6093/02

7 Oct 2019  
1 hour 45 minutes  
0820h – 1005h

Name: \_\_\_\_\_ (    )    Class: \_\_\_\_\_

#### READ THESE INSTRUCTIONS FIRST

Write your full name, class and index number in the spaces provided on the question paper and on any separate writing papers provided.

Write in blue or black pen.

Do not use staples, paper clips, highlighters, glue or correction fluid.

#### Section A

Answer all questions.

Write your answers in the spaces provided on the Question Paper.

#### Section B

Answer all questions.

Write your answers in the spaces provided on the Question Paper.

Electronic calculators may be used.

You are advised to spend no longer than one hour on Section A and no longer than 45 minutes on Section B.

At the end of the examination fasten all your work securely together.

The number of marks is given in brackets [ ] at the end of each question or part question.

	Marks Awarded	Max Marks
Section A		50
Section B		30
Total		80

This question paper consists of 18 printed pages including the cover page.

**Setter: Ms Michelle Tham**

**Section A [50 marks]**

Answer ALL questions in the spaces provided.

1. Fig 1.1 shows an experimental set-up to investigate the digestion of starch under different conditions.

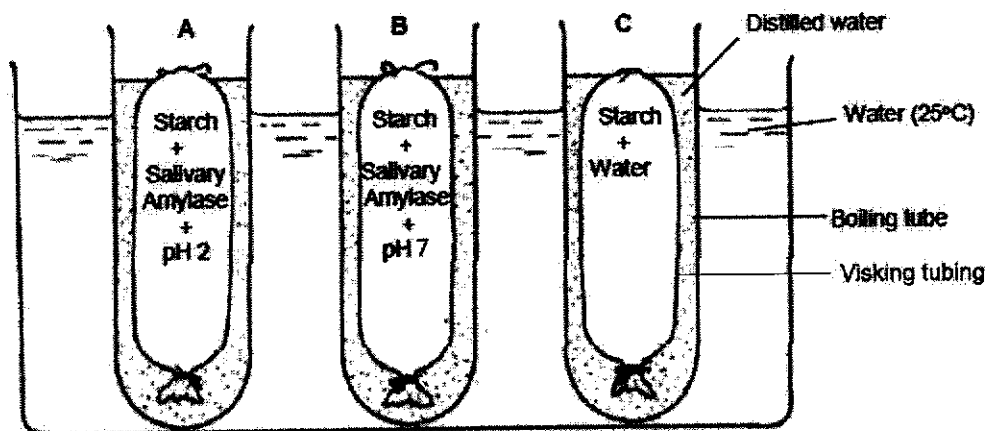

Fig. 1.1

The distilled water in the three boiling tubes, A, B and C, surrounding the Visking tubings was tested for the presence of starch and reducing sugars at the start of the experiment, and again after one hour.

The results are shown in Table 1.1.

Distilled water in boiling tube	Starch			Reducing sugars		
	A	B	C	A	B	C
Start of experiment	Absent			Absent		
After one hour	Absent			Present only in one of the distilled water in the boiling tubes		

Table 1.1

- (a) Name the reagent used to test for starch. [1]

.....

- (b) Explain why starch was absent in the distilled water in all boiling tubes even after an hour. [1]

.....

.....

- (c) Identify the boiling tube, **A**, **B** or **C**, which contained reducing sugars in the distilled water surrounding the Visking tubing after one hour. [1]

.....

- (d) Explain why the boiling tube stated in part (c) contained reducing sugars in the distilled water after an hour. [2]

.....  
 .....  
 .....

[5 marks]

2. Fig. 2.1 shows part of a mammalian small intestine with a magnified view of a villus.

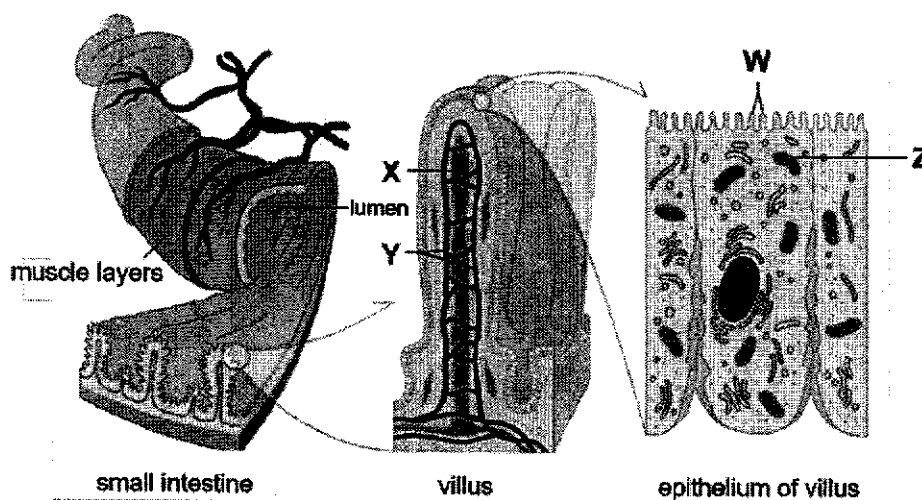

Fig. 2.1

- (a) Identify the structures labelled **W**, **X**, **Y** and **Z**. [2]

**W:** .....

**X:** .....

**Y:** .....

**Z:** .....

- (b) The small intestine has two muscle layers surrounding the lumen. Suggest the function of the muscle layers in the small intestine. [2]

.....  
 .....  
 .....

- (c) Explain how **W** aids in absorption of nutrients in the small intestine. [1]

.....  
 .....

[5 marks]

3. Fig. 3.1 shows a leaf of a giant water lily plant, which grows in the Amazon River in South America. The leaf has a diameter of up to 2 metres and the stomata of the giant lily leaf are found only on its upper surface.

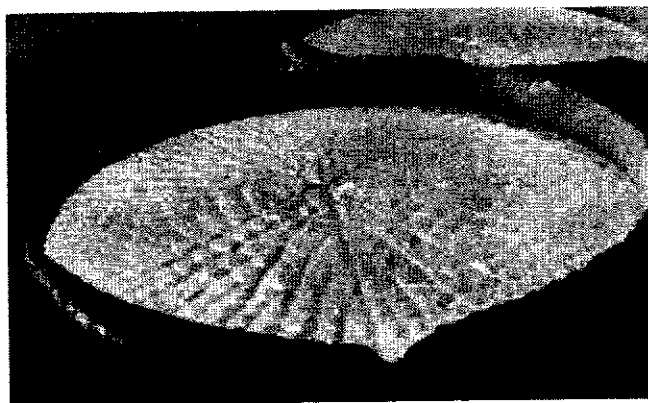

Fig. 3.1

- (a) Suggest and explain one way in which the leaf is adapted to maximise light absorption for photosynthesis. [2]

.....  
 .....

- (b) Explain the importance of having stomata only on the upper surface of the giant water lily's leaf. [2]

.....  
 .....



(c) Fig. 3.2 shows a section through a leaf of the giant water lily plant.

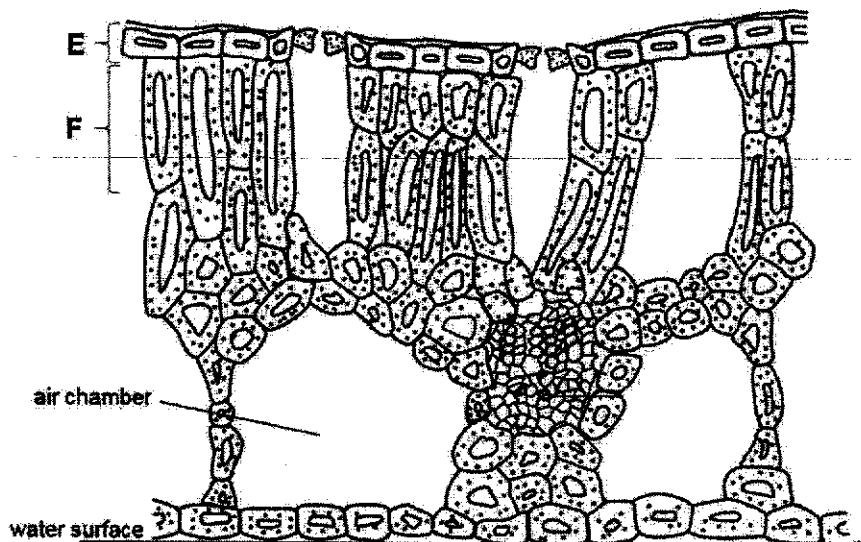

Fig. 3.2

(i) Identify the types of cells found at E and F. [2]

E: .....

F: .....

(ii) Suggest a reason why the air chambers in the giant water lily plant are larger than those found in typical land plants. [1]

.....  
 .....

[7 marks]

4. Fig. 4.1 shows an experiment on the uptake of water by a leafy shoot placed in a windy environment. The rate of movement of the air bubble is recorded before and after the black polyethene cover is placed over the plant.

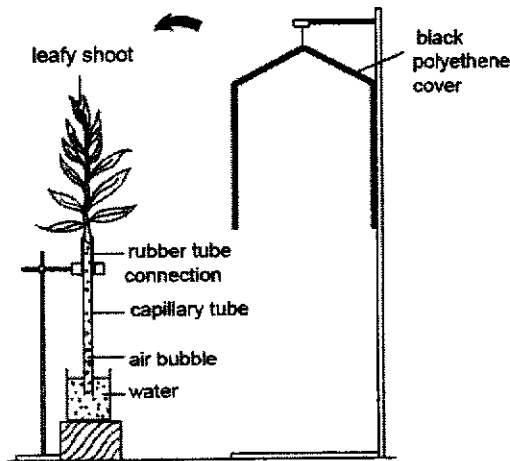

Fig. 4.1

Fig. 4.2 shows the rate of movement of the air bubble over time.

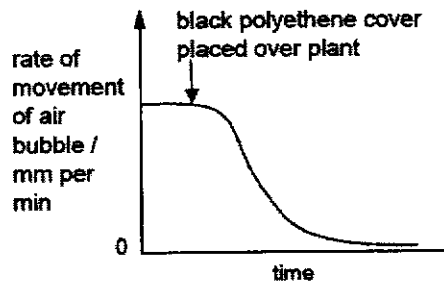

Fig. 4.2

- (a) Explain why the air bubble moved up towards the leafy shoot. [2]
- .....
- .....
- (b) Describe and explain the results shown in the graph after the black polyethene cover is placed over the plant. [4]
- .....
- .....
- .....
- .....
- .....

[6 marks]

5. A man fell and had a bad cut on his arm, which was still bleeding after an hour. He then went to the hospital to do a blood test.

Table 5.1 shows the results of his blood test.

test	result	normal range
platelets	98	140 – 200
cholesterol	297	112 – 328
iron	120	12 - 300
blood group	O	

Table 5.1

- (a) With reference to Table 5.1, explain why the man's cut did not stop bleeding even after an hour. [3]

.....

.....

.....

.....

- (b) The nurse wanted to give the man a blood transfusion using blood from a donor with blood group A. [3]  
State and explain if the nurse's decision is advisable.

.....

.....

.....

.....

[6 marks]

6. Fig. 6.1 shows different stages of mitosis.

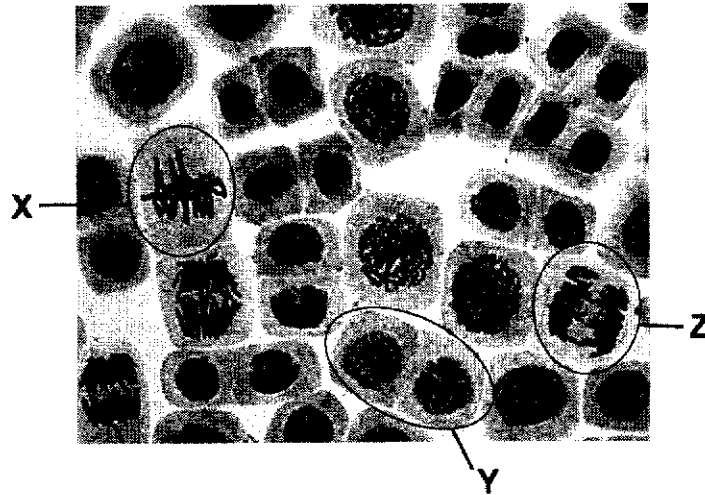

Fig. 6.1

(a) Identify stages X, Y and Z. [3]

X: .....

Y: .....

Z: .....

(b) Fig. 6.2 shows the mass of DNA in a cell of a horse during mitosis. The diploid number of a horse cell is 64.

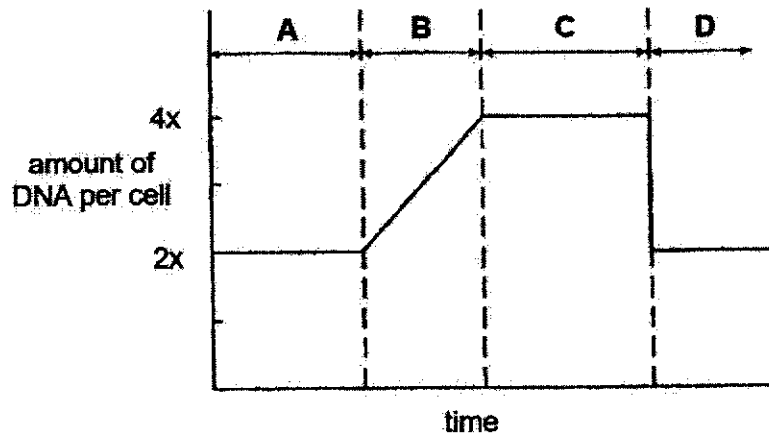

Fig. 6.2

(i) Identify the stage, A, B, C or D, in which interphase occurs. [1]

.....

- (ii) State the number of chromosomes at  
 stage C: .....  
 stage D: .....

[2]

[6 marks]

7. Fig. 7.1 shows three species of zebras.

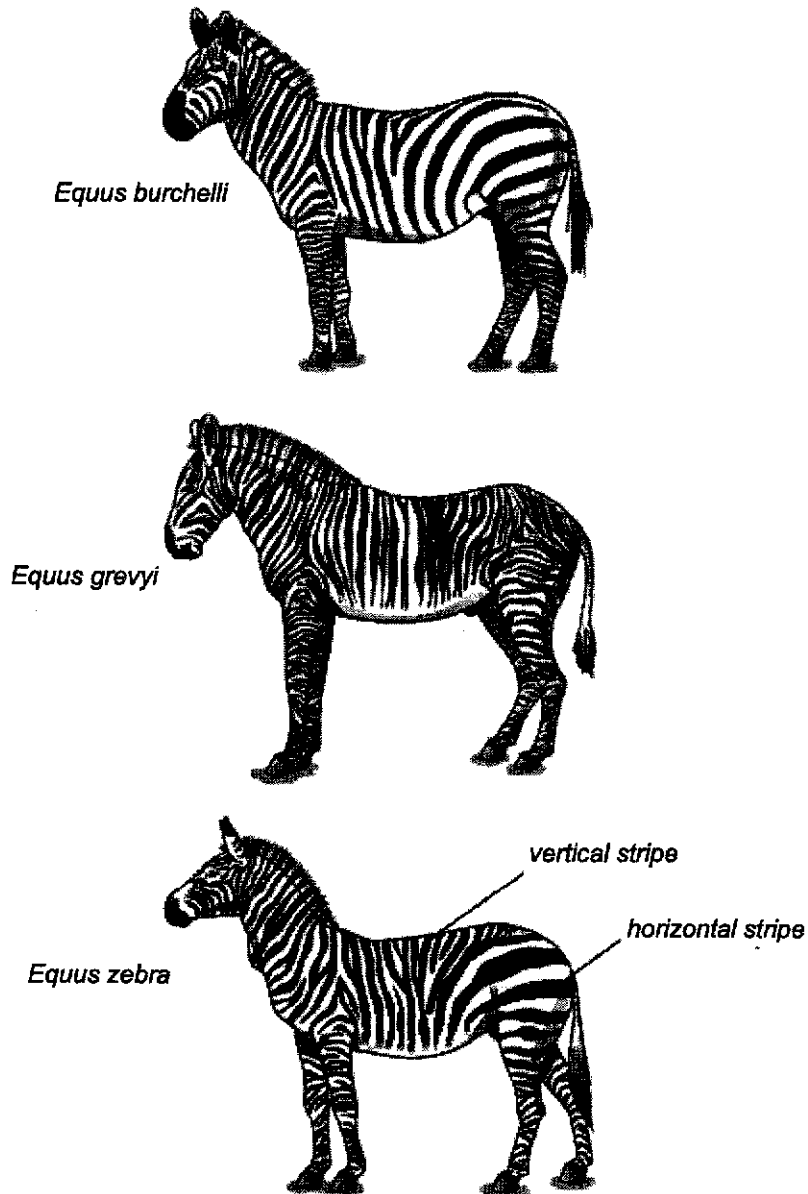

Fig. 7.1

- (a) Studies have shown that the hotter the environment, the more stripes the zebras have. [1]  
zebras have.

State the type of variation that would result in the different number of stripes in zebras.

.....

- (b) With reference to Fig. 7.1, suggest which type of zebra lives in the hottest environment. [1]

.....

- (c) Fig. 7.2 shows some molecules involved in the synthesis of the protein responsible for the production of the black pigment in zebras.

Complete the bases on the template DNA strand on Fig. 7.2 from which the mRNA was transcribed. [1]

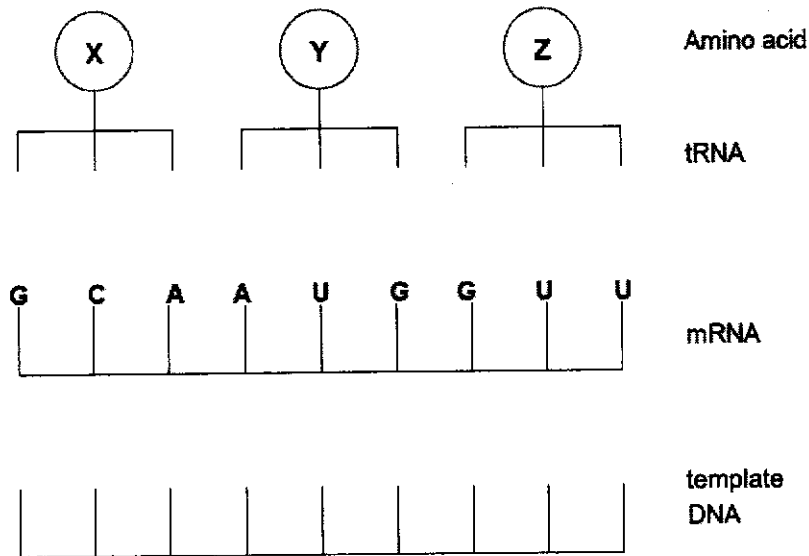

Fig. 7.2

- (d) On rare occasions, zebras that are almost completely black can be born to normal parents, due to mutation.

Fig. 7.3 shows the effect of this mutation on the base sequence of the mRNA. The table shows the mRNA codons for three amino acids.

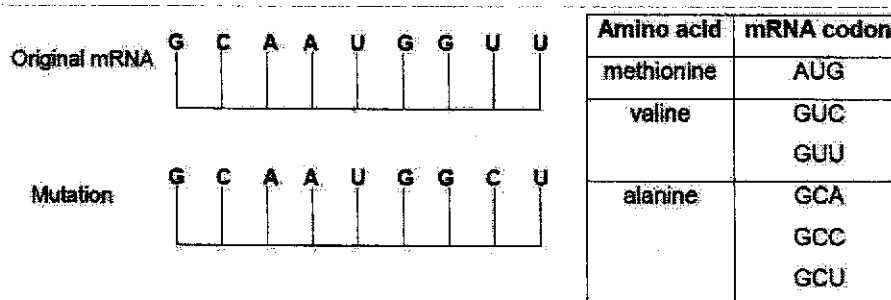

Fig. 7.3

Explain how the mutation in Fig. 7.3 may affect the polypeptide coded by this section of the gene. [2]

.....

.....

.....

[5 marks]

8. Sickle cell anaemia is an inherited disease. Individuals who are homozygous recessive suffer from the disease.

Fig. 8.1 shows how sickle cell anaemia was inherited in one family.

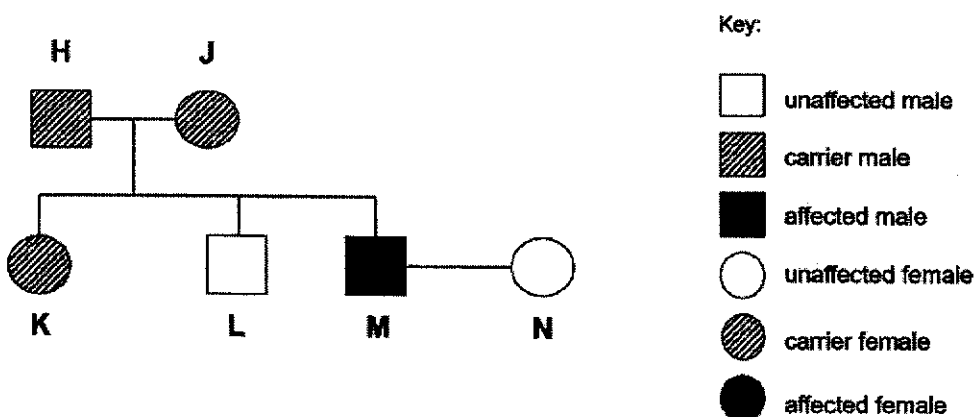

Fig. 8.1

- (a) Using the symbols A and a, state the genotype of parent H. [1]

.....

- (b) J was the first person in her family to carry the diseased allele. Both her parents do not have the disease and are homozygous dominant. [2]

Suggest how J became a carrier.

.....  
 .....  
 .....

- (c) Identify two individuals in Fig. 8.1 who are homozygous. [1]

.....

- (d) Draw a genetic diagram to show the possible genotypes and phenotypes of any children produced by parents M and N. Use the symbols A and a to represent the alleles. [5]

Parental phenotype:

Parental genotype:

Gametes:

F1 genotypes:

F1 phenotypes:

- (e) The expected phenotypic ratio of human males conceived to females is 1:1. However, M and N eventually had four children, whereby all of them are boys. [1]  
 Provide an explanation for this occurrence.

.....  
 .....

[10 marks]



**Section B [30 marks]**

Answer three questions. Write your answers in the spaces provided.

Question 11 is in the form of an Either/Or question. Only one part should be answered.

9. An experiment was carried out to investigate the effect of different concentrations of sugar solution on potato tissue. 50 cubes of potato tissue of the same dimensions were cut and weighed.

Ten cubes were placed in pure water and ten placed in each of four different concentrations of sugar solutions. The cubes were left for one hour. They were then removed from the solutions, dried carefully with blotting paper and weighed again.

Table 9.1 shows the results obtained from the experiment.

concentration of sugar solution / g per 100 cm <sup>3</sup>	mean initial mass / g	mean final mass / g	mean change in mass / g
0	2.21	2.40	+0.19
5	2.25	2.35	+0.10
10	2.23	2.30	
25		2.19	-0.06
40	2.20	2.02	-0.18

**Table 9.1**

- (a) Fill in the blanks in Table 9.1. [1]
- (b) Explain why the potato cubes in the 5 g/ 100 cm<sup>3</sup> sugar solution gained mass. [2]
- .....
- .....
- .....
- (c) Suggest a reason why ten potato cubes were placed in each different concentration instead of one potato cube. [1]
- .....

- (d) On the grid provided below, plot a graph to show the relationship between the mean change in mass of the potato cubes and concentration of sugar solution. [4]

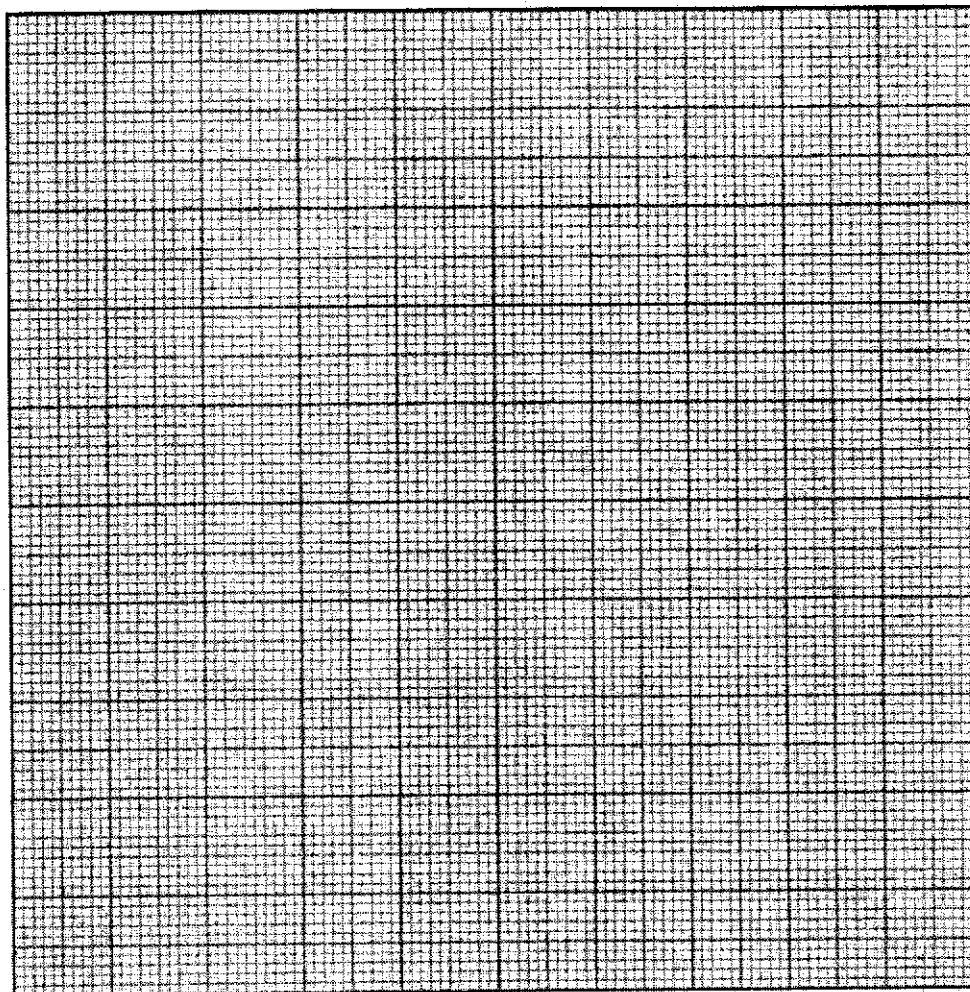

- (e) Use the graph to find the concentration of sugar solution at which there was no change in mass of potato cubes. [1]

.....

- (f) Suggest one way this experimental set-up could be improved to minimize experimental error. [1]

.....

.....

[10 marks]

10. Fig. 10.1 shows the nucleus of a cell containing four chromosomes.

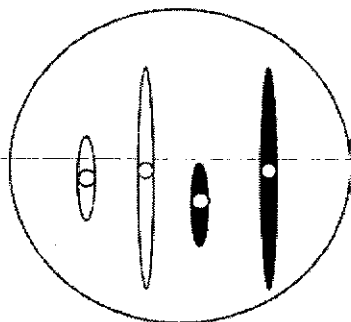
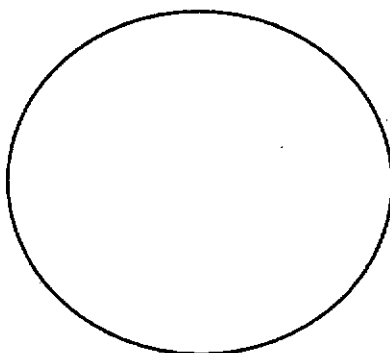
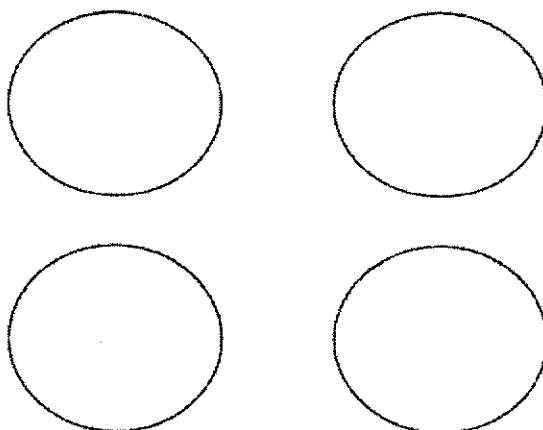

Fig. 10.1

- (a) In the circle below, draw how the chromosomes in Fig. 10.1 would look like during metaphase of mitosis. [1]  
 (spindle fibres and centrioles are not required.)



- (b) In the circles below, draw the four combinations of chromosomes produced from the cell in Fig. 10.1, at the end of meiosis. [2]  
 (no other details, including crossing over, are required.)



- (c) Explain the term 'homologous chromosomes'. [2]

.....

.....

- (d) Genetic engineering has been used for the production of human growth hormone to treat people with a growth hormone deficiency. In the procedure, bacteria is used to express the gene for human growth hormone. [5]

Outline how bacteria is used to produce human growth hormone on a large-scale.

.....

.....

.....

.....

.....

.....

.....

.....

.....

.....

[10 marks]

**11 Either**

- (a) Describe and explain how a red blood cell and a root hair cell are adapted to their functions. [6]

.....

.....

.....

.....

.....

.....

.....

.....

.....

.....

.....

.....

.....

.....

.....

.....

.....

.....

.....

.....

.....

.....

- (b) Describe what could happen to amino acid molecules once they are transported to the liver after absorption. [4]

.....

.....

.....

.....

.....

.....

.....

.....

[10 marks]

11 Or

- (a) With reference to trypsin, explain the lock and key model of enzyme action. [6]

.....

.....

.....

.....

.....

.....

.....

.....

.....

.....

.....

.....

.....

.....

.....

.....

.....

.....

.....

.....

(b) Describe how two named tissues involved in transport are arranged in the roots and stems of a plant, and state their functions. [4]

.....

.....

.....

.....

.....

.....

.....

[10 marks]

- End of Section B -



## Paper 1

Qn	Answer	Qn	Answer
1	A	21	A
2	C	22	B
3	C	23	D
4	C	24	C
5	D	25	D
6	C	26	D
7	D	27	C
8	B	28	A
9	D	29	B
10	B	30	D
11	B	31	A
12	A	32	B
13	D	33	A
14	D	34	A
15	B	35	B
16	C	36	A
17	A	37	B
18	D	38	C
19	C	39	C
20	C	40	C



**2019 Semestral Assessment 2  
Secondary Three Express**

**BIOLOGY**  
6093/02

7 Oct 2019  
1 hour 45 minutes  
0820h - 1005h

**MARK SCHEME**

**Section A [50 marks]**  
*Answer ALL questions in the spaces provided.*

1. Fig 1.1 shows an experimental set-up to investigate the digestion of starch under different conditions.

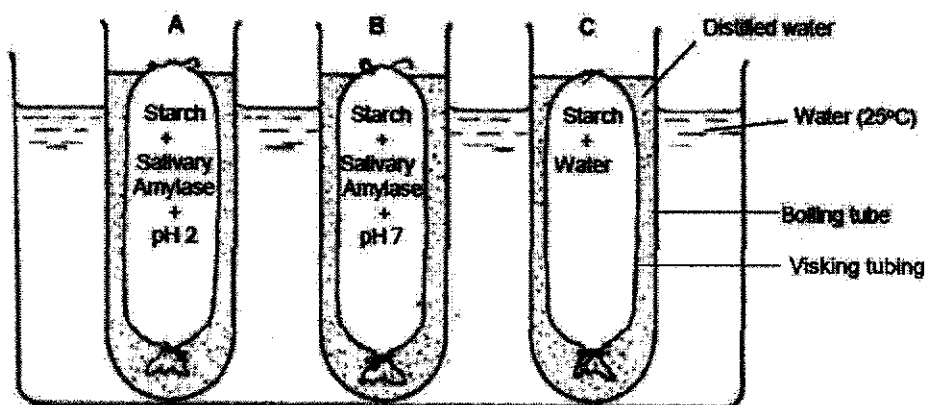

**Fig. 1.1**

The distilled water in the three boiling tubes, A, B and C, was tested for the presence of starch and reducing sugars at the start of the experiment, and again after one hour.

The results are shown in Table 1.1.

Distilled water in boiling tube	Starch			Reducing sugars		
	A	B	C	A	B	C
Start of experiment	Absent			Absent		
After one hour	Absent			Present only in the distilled water surrounding one of the boiling tubes		

**Table 1.1**

- (a) Name the reagent used to test for starch.

[1]

iodine

- (b) Explain why starch was absent in the boiling tubes even after an hour. [1]

Starch is too large to pass through the partially permeable membrane of the Visking tubing.

- (c) Identify the boiling tube, A, B or C, which contained reducing sugars. [1]

B

- (d) Explain why the boiling tube stated in part (c) contained reducing sugars [2]  
after an hour.

pH 7 is the optimum pH for salivary amylase.  
To break down starch into maltose, a reducing sugar.

[5 marks]

2. Fig. 2.1 shows part of a mammalian small intestine with a magnified view of a villus.

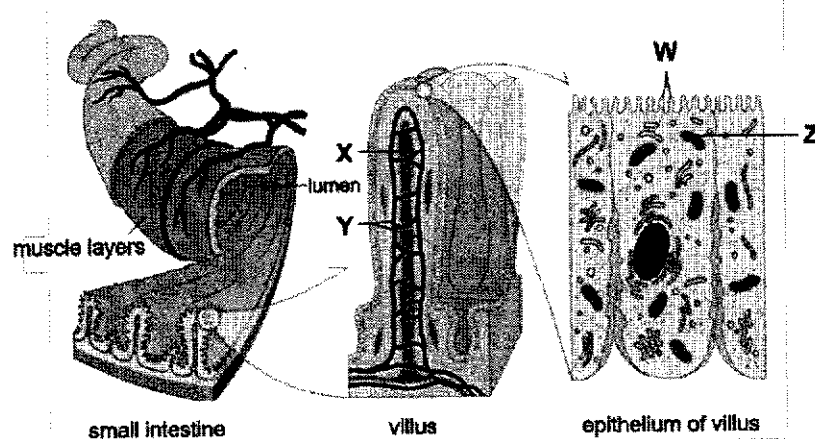

Fig. 2.1

- (a) Identify the structures labelled W, X, Y and Z. [2]

W: microvilli

X: lacteal/ lymphatic capillary

Y: blood capillary

Z: mitochondrion/mitochondria 2 correct: 1m

- (b) The small intestine has two muscle layers surrounding the lumen. Suggest the function of the muscle layers in the small intestine. [2]

The muscle layers allow peristalsis to take place,

in which the alternate contraction and relaxation of the muscles/antagonistic muscles allow food to be pushed forward in the small intestine.

- (c) Explain how **W** aids in absorption of nutrients in the small intestine. [1]

It increases the surface area/ surface area to volume ratio to increase the rate of absorption of nutrients.

[5 marks]

3. Fig. 3.1 shows a leaf of a giant water lily plant, which grows in the Amazon River in South America. The leaf has a diameter of up to 2 metres and the stomata of the giant lily leaf are found only on its upper surface.

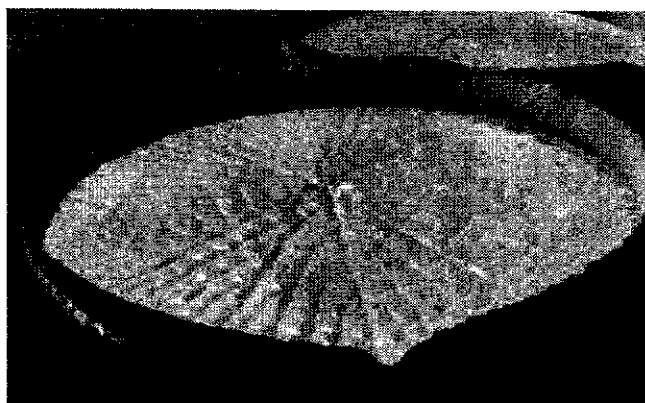

Fig. 3.1

- (a) Suggest and explain one way in which the leaf is adapted to maximise light absorption for photosynthesis. [2]

Broad/large/flat lamina to increase surface area to absorb light energy/

Thin lamina to allow light to penetrate and reach all mesophyll cells.

- (b) Explain the importance of having stomata only on the upper surface of the giant water lily's leaf. [2]

All the stomata are on the upper surface to maximize air exposure/ so that none of the stomata are submerged in water;

Hence, gaseous exchange/movement of oxygen and carbon dioxide between the leaf and the surrounding air is more effective.

- (c) Fig. 3.2 shows a section through a leaf of the giant water lily plant.

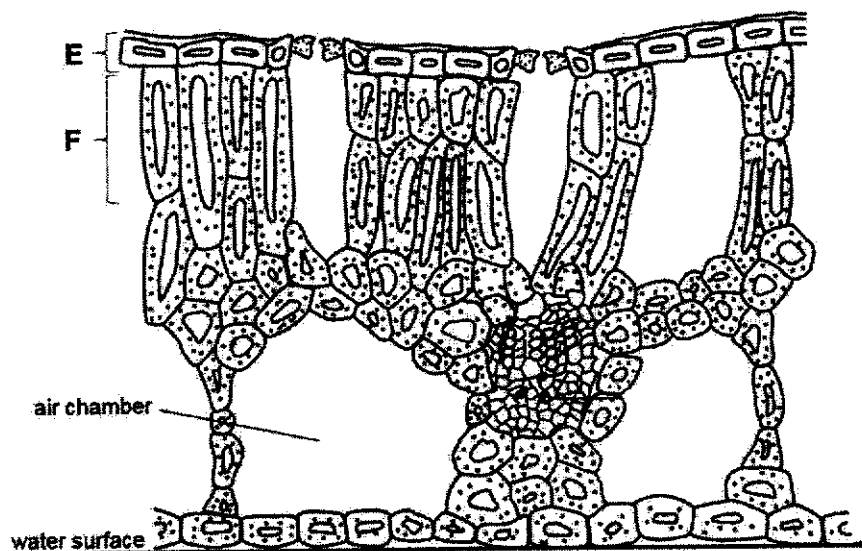

Fig. 3.2

- (i) Identify the types of cells found at E and F. [2]

E: (upper) epidermis/epidermal cells

F: palisade mesophyll

- (ii) Suggest a reason why the air chambers in the giant water lily plant are larger than those found in typical land plants. [1]

To provide buoyancy/to lower density/ to allow giant water lily to float on water.

[7 marks]

4. Fig. 4.1 shows an experiment on the uptake of water by a leafy shoot placed in a windy environment. The rate of movement of the air bubble is recorded before and after the black polyethene cover is placed over the plant.

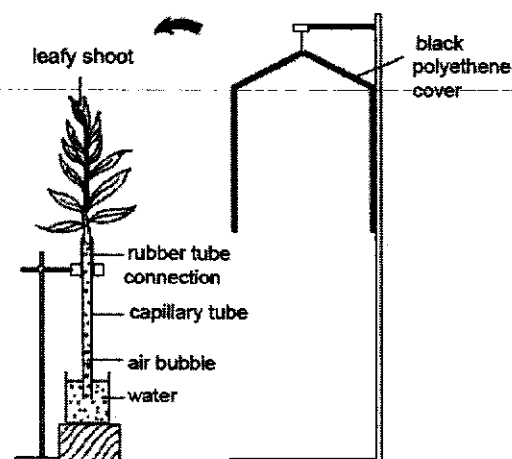

Fig. 4.1

Fig. 4.2 shows the rate of movement of the air bubble over time.

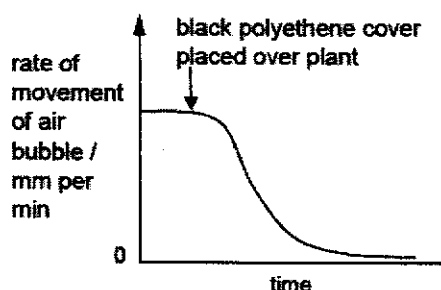

Fig. 4.2

- (a) Explain why the air bubble moved up towards the leafy shoot. [2]
- (b) Describe and explain the results shown in the graph after the black polyethene cover is placed over the plant. [4]

Describe: rate of movement of bubble decreases; [1]

Explain: wind cannot reach the leaf;  
 water vapour builds up around leaf/ humidity around leaf increases;  
 rate of transpiration/evaporation/water loss slows down;  
 diffusion gradient becomes less steep;  
 or

stomata closes (due to darkness);  
 photosynthesis stops/rate of photosynthesis decreases;  
 less water taken up for photosynthesis;

[6 marks]

5. A man fell and had a bad cut on his arm, which was still bleeding after an hour. He then went to the hospital to do a blood test.

Table 5.1 shows the results of his blood test.

test	result	normal range
platelets	98	140 – 200
cholesterol	297	112 – 328
iron	120	12 - 300
blood group	O	

Table 5.1

- (a) With reference to Table 5.1, explain why the man's cut did not stop bleeding even after an hour. [3]

His platelet count is lower than normal; [1]

Little or no thrombokinase is produced;

Which is needed to convert prothrombin to thrombin; (*either point*)

Without thrombin, fibrinogen cannot be converted to insoluble fibrin threads to form a clot. [1]

- (b) The nurse wanted to give the man a blood transfusion using blood from a donor with blood group A. [3]  
State and explain if the nurse's decision is advisable.

No;

The man will have antibodies a in his blood plasma,

Which will agglutinate with the donor's antigen A on his red blood cells.

[6 marks]

6. Fig. 6.1 shows different stages of mitosis.

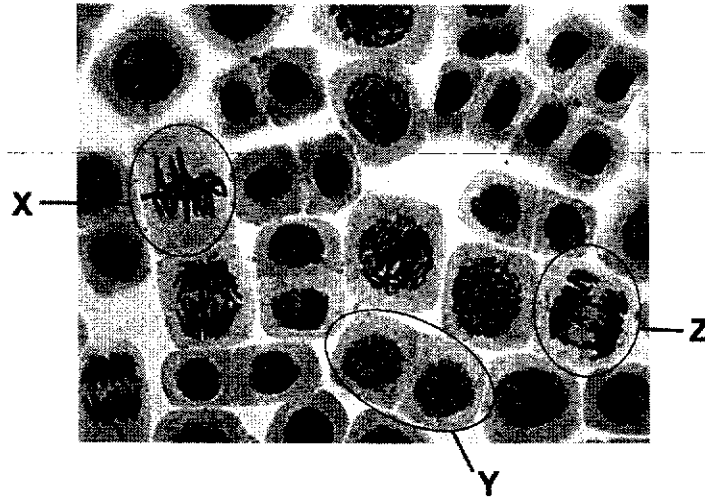

Fig. 6.1

- (a) Identify stages X, Y and Z. [3]

X: metaphase

Y: cytokinesis/telophase

Z: anaphase

- (b) Fig. 6.2 shows the mass of DNA in a cell of a horse during mitosis. The diploid number of a horse cell is 64.

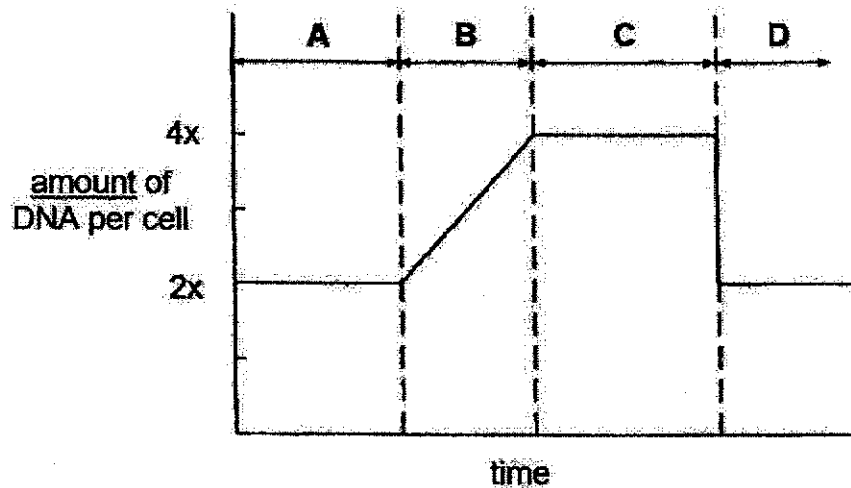

Fig. 6.2

- (i) Identify the stage, A, B, C or D, in which interphase occurs. [1]

B

(ii) State the number of chromosomes at

[2]

stage C: 64

stage D: 64

[6 marks]

7. Fig. 7.1 shows three species of zebras.

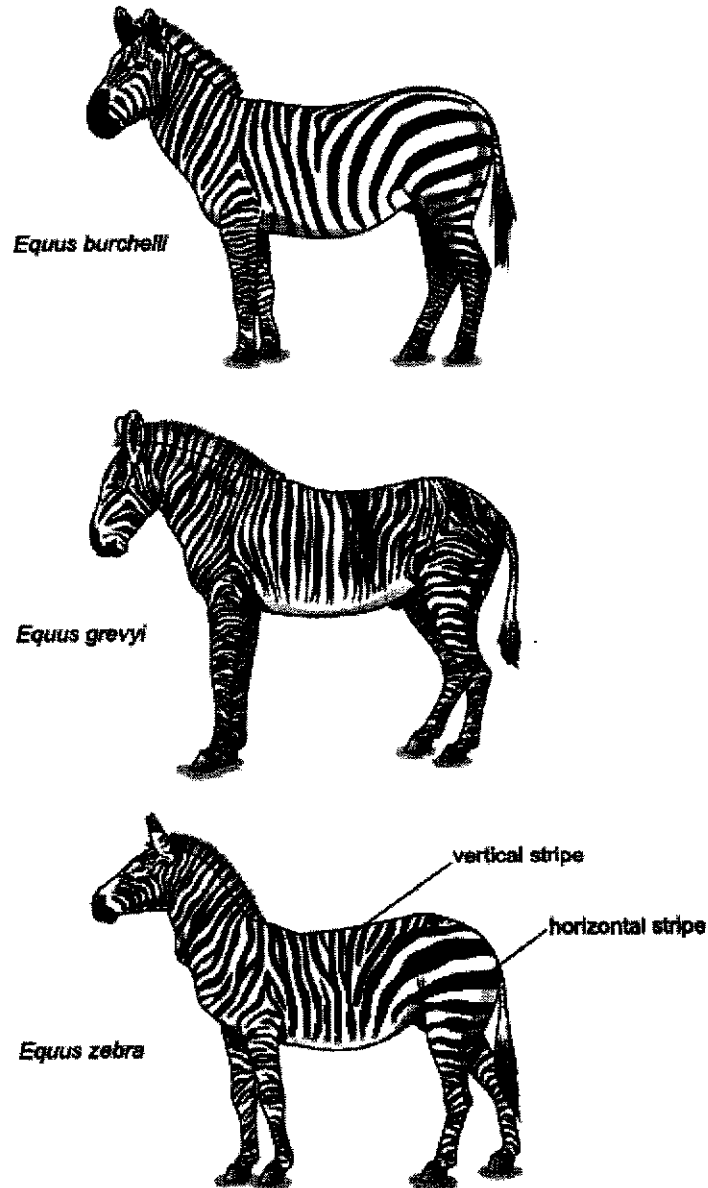

Fig. 7.1



- (a) Studies have shown that the hotter the environment, the more stripes the zebras have. [1]

State the type of variation that would result in the different number of stripes in zebras.

Continuous

- (b) With reference to Fig. 7.1, suggest which type of zebra lives in the hottest environment. [1]

*Equus grevyi*

- (c) Fig. 7.2 shows some molecules involved in the synthesis of the protein responsible for the production of the black pigment in zebras.

Complete the bases on the template DNA strand on Fig. 7.2 from which the mRNA was transcribed. [1]

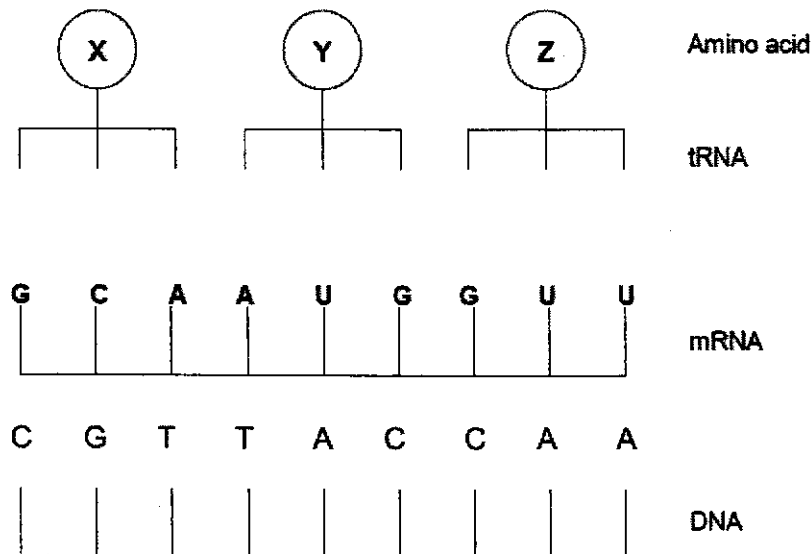

Fig. 7.2

- (d) On rare occasions, zebras that are almost completely black can be born to normal parents, due to mutation.

Fig. 7.3 shows the effect of this mutation on the base sequence of the mRNA. The table shows the mRNA codons for three amino acids.

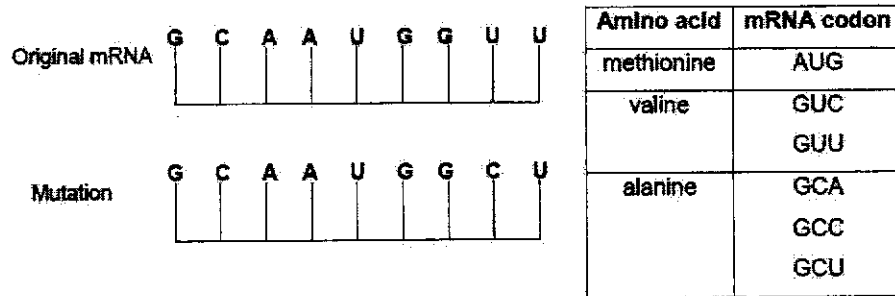

Fig. 7.3

Explain how the mutation in Fig. 7.3 may affect the polypeptide coded by this section of the gene. [2]

The mutation leads to a change in the sequence of amino acids as GCU codes for alanine instead of valine;

This would lead to a change in the final 3D structure of the polypeptide and therefore a change in its function.

[5 marks]

8. Sickle cell anaemia is an inherited disease. Individuals who are homozygous recessive suffer from the disease.

Fig. 8.1 shows how sickle cell anaemia was inherited in one family.

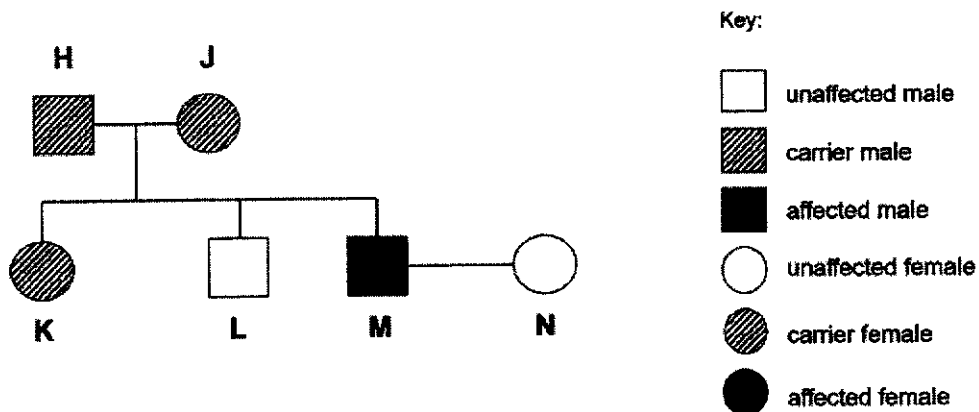

Fig. 8.1

- (a) Using the symbols A and a, state the genotype of parent H. [1]

Aa

- (b) J was the first person in her family to carry the diseased allele. Both her parents do not have the disease and are homozygous dominant. [2]

Suggest how J became a carrier.

Gene mutation;

Occur in the gamete /sperm/egg of J's parent/during gamete formation in meiosis

- (c) State two individuals in Fig. 8.1 who are homozygous. [1]

L/M/N (any 2)

- (d) Draw a genetic diagram to show the possible genotypes and phenotypes of any children produced by parents M and N. Use the symbols A and a to represent the alleles. [5]

Parental phenotype: affected x unaffected  
Parental genotype: aa x AA

Gametes: (a) (a) (A) (A)

F1 genotypes: all Aa

F1 phenotypes: all carriers

- (e) The expected phenotypic ratio of human males conceived to females is 1:1. However, M and N eventually had four children, whereby all of them are boys. [1]  
Provide an explanation for this occurrence.

Sample size is too small to predict the expected ratio accurately/

Fertilisation is random/

There is 50% chance of each gender occurrence.

[10 marks]

**Section B [30 marks]**

Answer three questions. Write your answers in the spaces provided.

Question 11 is in the form of an Either/Or question. Only one part should be answered.

9. An experiment was carried out to investigate the effect of different concentrations of sugar solution on potato tissue. 50 cubes of potato tissue of the same dimensions were cut and weighed.

Ten cubes were placed in pure water and ten placed in each of four different concentrations of sugar solutions. The cubes were left for one hour. They were then removed from the solutions, dried carefully with blotting paper and weighed again.

Table 9.1 shows the results obtained from the experiment.

concentration of sugar solution / g per 100 cm <sup>3</sup>	mean initial mass / g	mean final mass / g	mean change in mass / g
0	2.21	2.40	+0.19
5	2.25	2.35	+0.10
10	2.23	2.30	+0.07
25	<u>2.25</u>	2.19	-0.06
40	2.20	2.02	-0.18

**Table 9.1**

- (a) Fill in the blanks in Table 9.1. [1]
- (b) Explain why the potato cubes in the 5g/100 cm<sup>3</sup> sugar solution gained mass. [2]

The sugar solution has a higher water potential than that of potato cell sap;

Water molecules entered the potato cells by osmosis;

- (c) Suggest a reason why ten potato cubes were placed in each different concentration instead of one potato cube. [1]

More reliable/accurate results/ overcome anomalous results.

- (d) On the grid provided below, plot a graph to show the relationship between the mean change in mass of the potato cubes and concentration of sugar solution. [4]

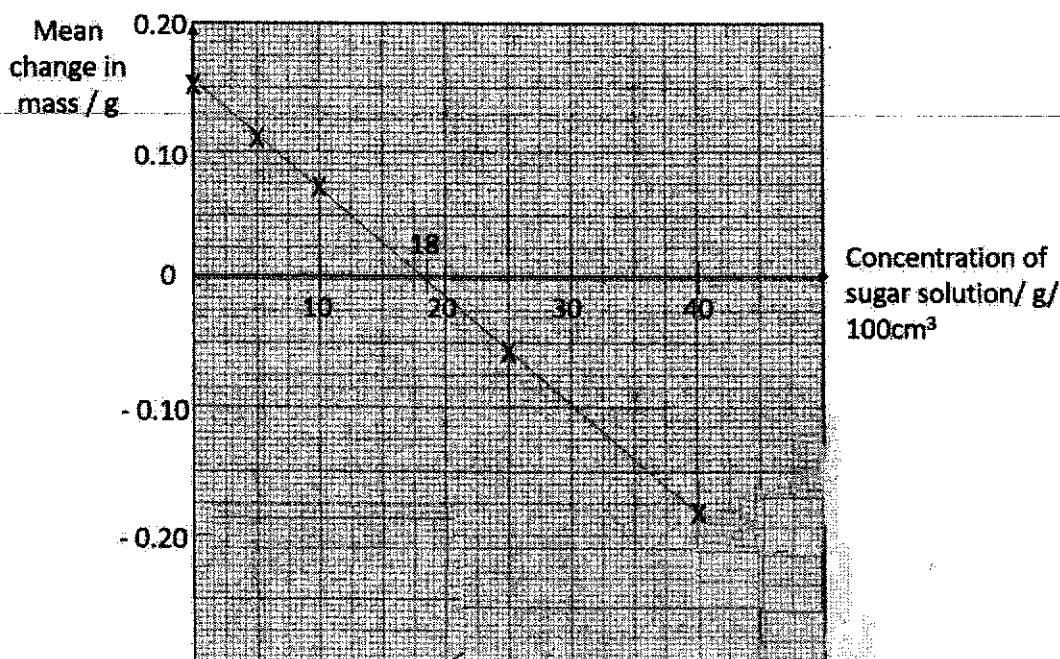

Graph – 1m  
 Axis – 1m  
 Plotting – 1m  
 Scale – 1m

- (e) Use the graph to find the concentration of sugar solution at which there was no change in mass of potato cubes. [1]

Suggested: 18 g/100 cm<sup>3</sup> (check graph) *no mark awarded for missing units*

- (f) Suggest one way this experimental set-up could be improved to minimize experimental error. [1]

Cover the petri dishes/

The potato strips used must be from the same potato./

Repeat the experiments to collect several readings/

The potato cubes must be blotted dry before measurement of mass is taken.

*Any possible answers*

[10 marks]

10. Fig. 10.1 shows the nucleus of a cell containing four chromosomes.

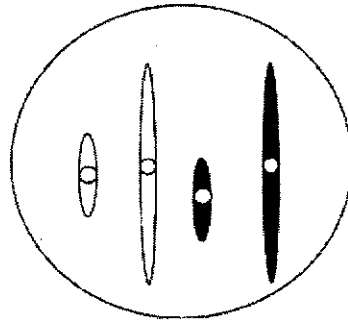
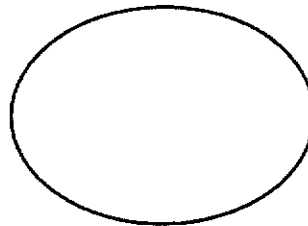

Fig. 10.1

- (a) In the circle below, draw how the chromosomes in Fig. 10.1 would look like during metaphase of mitosis. [1]  
 (spindle fibres and centrioles are not required.)



-all 4 chromosomes in a single row  
 -2 sister chromatids for each chromosome

- (b) In the circles below, draw the four combinations of chromosomes produced from the cell in Fig. 10.1, at the end of meiosis. [2]  
 (no other details, including crossing over, are required.)

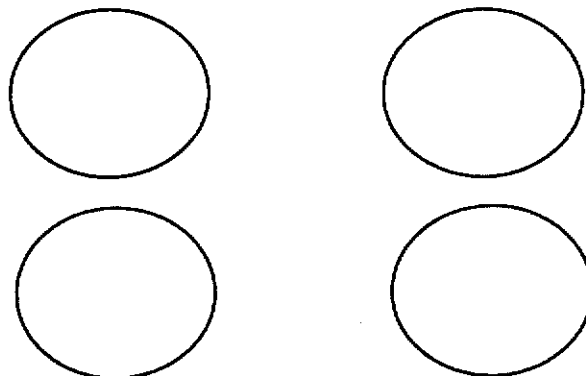

-One short and one long chromatid in each circle  
 -can be one black and one white chromatid, or both black, or both white  
 -2 correct: 1m

- (c) Explain the term 'homologous chromosomes'. [2]

A pair of chromosomes that have the same shape, size and genes;

One from mother, one from father.

- (d) Genetic engineering has been used for the production of human growth hormone to treat people with a growth hormone deficiency. In the procedure, bacteria is used to express the gene for human growth hormone. [5]

Outline how bacteria is used to produce human growth hormone on a large-scale.

Use restriction enzyme to cut the gene for human growth hormone;

Use same restriction enzyme to cut the bacterial plasmid;

Join the human growth hormone gene and plasmid together with DNA ligase;

Mix the recombinant plasmid with bacteria and apply heat/electric shock;

Culture the transgenic bacteria in fermenters for mass production of human growth hormone.

[10 marks]

### 11 Either

- (a) Describe and explain how a red blood cell and a root hair cell are adapted to their functions. [6]

RBC:

Function: transport oxygen; [1]

No nucleus so it can store more haemoglobin;

Biconcave shape to increase surface area to volume ratio;

Elastic so it can squeeze through small capillaries.

RHC:

Function: absorb water and mineral salts; [1]

Long and narrow to increase surface area to volume ratio;

Numerous mitochondria to provide energy for active transport of dissolved mineral salts.

*Max 3 marks for each specialised cell*

- (b) Describe what could happen to amino acid molecules once they are transported to the liver after absorption. [4]

The amino acid molecule is combined to form polypeptides and eventually into specific proteins;

Any excess amino acids will be deaminated;

Urea formed is removed in urine;

Remains of deaminated amino acids are converted into glucose;

Any excess glucose is converted into glycogen.

[10 marks]

11 Or

- (a) With reference to trypsin, explain the lock and key model of enzyme action. [6]

Trypsin is the lock; protein is the key;

Shape of protein molecule is complementary/specific to active site of trypsin;

Forming enzyme-substrate complex for reaction to take place;

Polypeptides are formed as product and leave active site;

Active site of trypsin remains unchanged;

so another protein molecule can fit into it.



- (b) Describe how two named tissues involved in transport are arranged in the roots and stems of a plant, and state their functions. [4]

Xylem occupies the centre of the roots; phloem is arranged around the xylem/alternating;

Phloem are arranged in vascular bundles with xylem around the edge of the stem; phloem is located in the outer ring of the stem;

Phloem transports manufactured food such as sucrose and amino acids;

Xylem transports water and dissolved mineral salts.

*(max 1 mark for describing if students draw the structures)*

[10 marks]

**- End of Section B -**

