

Name and Index Number:  (      )	Class:
--	--------



## SENG KANG SECONDARY SCHOOL PRELIMINARY EXAMINATION

**CHEMISTRY**

**6092/01**

**Secondary 4 Express**

**31 August 2020**

Paper 1 Multiple Choice

**1 hour**

Additional Materials: Multiple Choice Answer Sheet

**READ THESE INSTRUCTIONS FIRST**

Write your index number and name on all the work you hand in.  
You may use a soft pencil for any diagrams, graphs or rough working.  
Do not use staples, paper clips, highlighters, glue or correction fluid.

There are **forty** questions in this paper. Answer **all** questions. For each question there are four possible answers **A, B, C** and **D**.  
Choose the **one** you consider correct and record your choice in soft pencil on the Multiple Choice Answer Sheet.

**Read the instructions on the Answer Sheet very carefully.**

Each correct answer will score one mark. A mark will not be deducted for a wrong answer.  
Any rough working should be done in this question paper.  
The use of an approved scientific calculator is expected, where appropriate.

A copy of the Periodic Table is printed on page 14.

Parent's / Guardian's Signature: .....

This document consists of 14 printed pages.  
**Do not turn over the page until you are told to do so.**

**[Turn over**

- 1 A student accidentally mixed  $100 \text{ cm}^3$  of water with  $100 \text{ cm}^3$  of oil.

Which method would allow her to obtain  $50 \text{ cm}^3$  of the oil most easily?

- A chromatography  
 B evaporation  
 C filtration  
 D use of a separating funnel

- 2 The diagram show two methods of collecting gases.

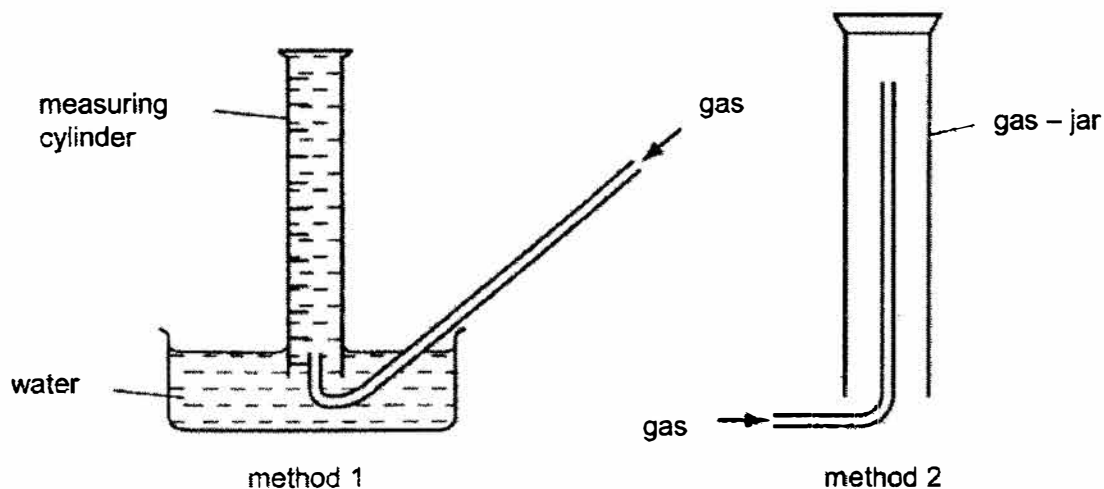

Which row gives the property of a gas which can be collected by both methods?

	property 1	property 2
A	insoluble in water	denser than air
B	insoluble in water	less dense than air
C	soluble in water	denser than air
D	soluble in water	less dense than air

- 3 The table gives data about four substances.

In which substance are the particles arranged randomly and moving rapidly at room temperature?

	melting point /°C	boiling point /°C
A	-114	-80
B	17	73
C	125	333
D	1610	2230

[Turn over

- 4 The pressure of a sample of gas is decreased. The temperature is kept constant.

Which row describes the effects on the particles?

	movement of particles	collisions between particles
A	slower	occur less often
B	slower	occur with more force
C	no change in speed	occur less often
D	no change in speed	occur with more force

- 5 A beaker of gaseous ethene ( $C_2H_4$ ) was inverted over a porous pot containing carbon monoxide as shown in the diagram below. The apparatus was left to stand for 15 minutes.

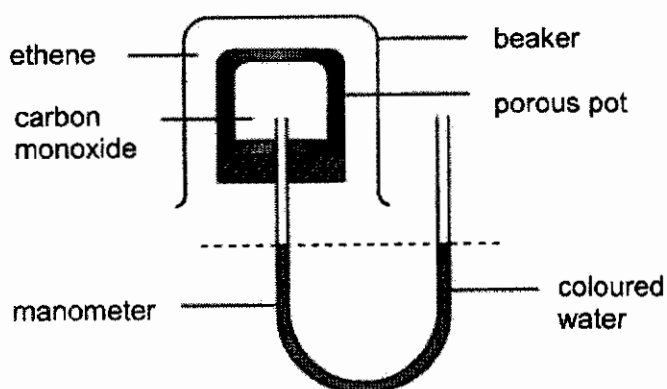

Why did the level of the coloured water in the manometer remain the same?

- A Both gases are compounds.  
 B Both gases have the same relative molecular mass.  
 C Ethene and carbon monoxide reacted with each other.  
 D The particles of the two gases are too large to pass through the porous pot.
- 6 A representation of an atom is shown below.

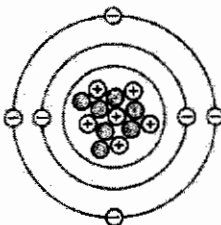

What is the nucleon number of this atom?

- A 6                      B 7                      C 12                      D 13

[Turn over

- 7 The diagrams show the nuclei of four different atoms.

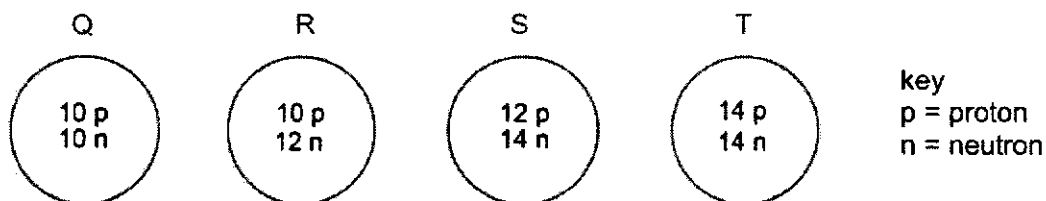

Which two atoms are isotopes of each other?

- A Q and R      B Q and T      C R and S      D S and T
- 8 Lithium reacts with fluorine to form the compound lithium fluoride.

Which statement about this reaction is correct?

- A Each fluorine atom gains one electron.  
 B Each fluorine atom gains two or more electrons.  
 C Each fluorine atom loses one electron.  
 D Each fluorine atom loses two or more electrons.
- 9 A gas has the molecular formula  $\text{NOCl}$ .

Which diagram could show molecules of the pure gas  $\text{NOCl}$ ?

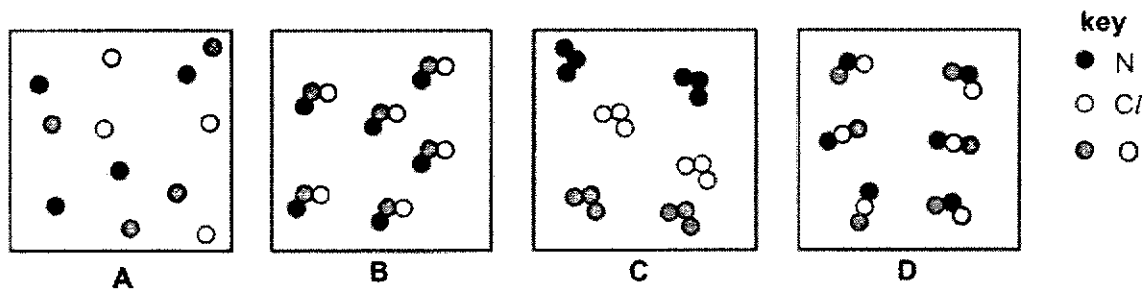

[Turn over

- 10 An excess of aqueous sodium hydroxide is added to an aqueous solution of salt X and boiled. Ammonia gas is only given off after aluminium foil is added to the hot solution.

What is X?

- A ammonium chloride  
 B ammonium nitrate  
 C sodium chloride  
 D sodium nitrate

- 11 Aqueous ammonia is added to a solution of a chloride salt. A white precipitate is formed which dissolves in an excess of aqueous ammonia.

Which metal ion is present in the salt?

- A aluminium  
 B calcium  
 C lead  
 D zinc

- 12 In which reaction is a white precipitate present when the reaction is complete?

- A Excess aqueous barium nitrate is added to aqueous sodium chloride.  
 B Excess aqueous sodium hydroxide is added to aqueous aluminium chloride.  
 C Excess aqueous sodium hydroxide is added to aqueous iron(II) sulfate.  
 D Excess hydrochloric acid is added to aqueous silver nitrate.

- 13 Chloroquine has been used in the treatment and prevention of malaria. In the recent Covid-19 pandemic, the President of a certain country has advocated the treatment of Covid-19 patients with chloroquine, which causes much controversy to arise in the medical arena.

The elements present in chloroquine are carbon, chlorine, hydrogen and nitrogen. The diagram below shows the incomplete structure of chloroquine. It is incomplete because the hydrogen atoms that are chemically bonded to the carbon atoms are not shown. Each carbon atom can form four bonds.

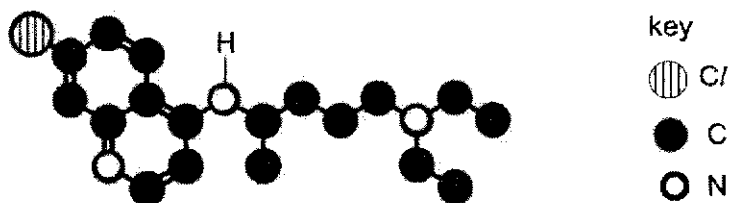

What is the molecular formula of chloroquine?

- A  $C_{18}HClN_3$   
 B  $C_{18}HCl_3N$   
 C  $C_{18}H_{26}ClN_3$   
 D  $C_{18}H_{26}Cl_3N$

[Turn over

- 14 The diagram shows the change from an anhydrous salt to its hydrated form.

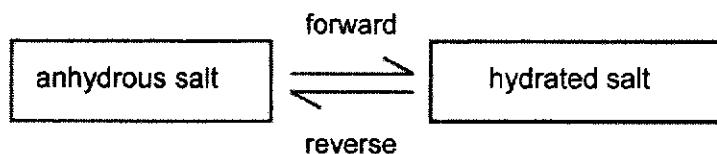

Which statement is correct?

- A The forward reaction requires heat and water.  
 B The forward reaction requires water only.  
 C The reverse reaction requires heat and water.  
 D The reverse reaction requires water only.
- 15 How many moles of iron can be extracted from 116 g of  $\text{Fe}_3\text{O}_4$ ?

- A 0.5 mol  
 B 1.0 mol  
 C 1.5 mol  
 D 3.0 mol

- 16 Which gas sample contains the most number of molecules?

- A 24  $\text{dm}^3$  of  $\text{CO}_2$   
 B 4 g of  $\text{H}_2$   
 C 36  $\text{dm}^3$  of  $\text{HCl}$   
 D 14 g of  $\text{N}_2$

- 17 A student mixed 25.0  $\text{cm}^3$  of 1.00  $\text{mol/dm}^3$  hydrochloric acid with 25.0 g of calcium carbonate.



What is the maximum volume of carbon dioxide gas that could be collected at room temperature and pressure?

- A 300  $\text{dm}^3$   
 B 6.00  $\text{dm}^3$   
 C 0.600  $\text{dm}^3$   
 D 0.300  $\text{dm}^3$

[Turn over



- 21 Four different acids are dissolved in water.

Which beaker contains the most concentrated strong acid solution?

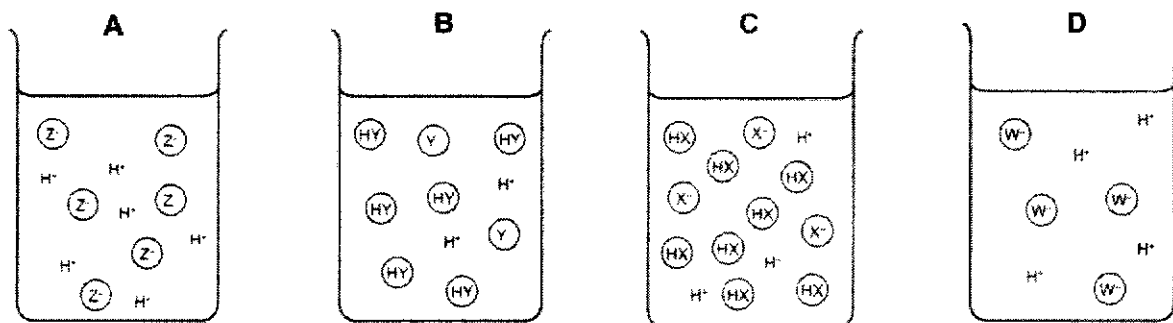

- 22 The following substances can be reacted together to prepare salts.

- 1 copper(II) oxide and excess hydrochloric acid
- 2 hydrochloric acid and excess sodium hydroxide
- 3 hydrochloric acid and excess zinc carbonate

In which reactions can the excess reactant be separated from the solution by filtration?

- |                  |                  |
|------------------|------------------|
| <b>A</b> 1 and 2 | <b>C</b> 2 and 3 |
| <b>B</b> 1 and 3 | <b>D</b> 3 only  |
- 23 Fertilisers are mixtures of different compounds used to increase the growth of crops.

Which pair of substances contain the three essential elements for plant growth?

- A ammonium nitrate and calcium phosphate
  - B ammonium nitrate and potassium chloride
  - C ammonium phosphate and potassium chloride
  - D potassium nitrate and calcium carbonate
- 24 A solution of a salt X gives an insoluble hydroxide Y on reacting with aqueous NaOH. Y dissolves in excess NaOH to give solution Z. On adding aqueous HCl to Z, the precipitate Y reappears but dissolves in excess HCl.

What type of hydroxide is hydroxide Y?

- |                     |                  |
|---------------------|------------------|
| <b>A</b> acidic     | <b>C</b> basic   |
| <b>B</b> amphoteric | <b>D</b> neutral |

[Turn over



- 25 The diagram shows an experiment to electroplate a nickel spoon with silver.

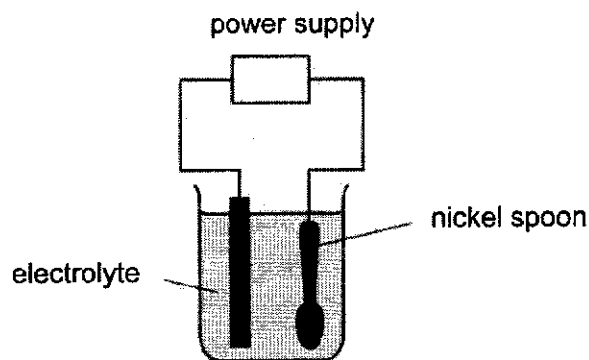

Which row correctly describes the positive electrode, negative electrode and electrolyte?

	positive electrode	negative electrode	electrolyte
<b>A</b>	nickel spoon	pure nickel	silver nitrate solution
<b>B</b>	nickel spoon	pure silver	nickel nitrate solution
<b>C</b>	pure nickel	nickel spoon	silver nitrate solution
<b>D</b>	pure silver	nickel spoon	silver nitrate solution

- 26 Which statement describes what happens when hydrogen and oxygen are used in a fuel cell?

- A** Electricity is generated directly.
- B** Electricity is used to produce water.
- C** Hydrogen is burned to form steam.
- D** Hydrogen reacts to form a hydrocarbon fuel.

- 27 Two reactions are done.

Reaction 1: Hydrated cobalt(II) chloride is heated. It changes colour.

Reaction 2: Water is added to the product of reaction 1. It becomes hotter. The original colour is produced.

Which types of reactions have occurred in reactions 1 and 2?

	endothermic	exothermic	neutralisation	reversible
<b>A</b>	✓	✓	✓	✓
<b>B</b>	✓	✓	✓	X
<b>C</b>	✓	✓	X	✓
<b>D</b>	✓	X	X	✓

[Turn over

28 Which factor decreases the activation energy of a reaction?

- A addition of a catalyst
- B increase in concentration of the reactants
- C increase in pressure
- D increase in temperature

29 Gas P decomposed to form gas Q as follow:  $xP \longrightarrow yQ$ .

Two experiments are carried out to investigate the rate of reaction. The conditions are the same except that two different temperatures,  $T_1$  and  $T_2$ , are used.

The results are plotted on graphs, drawn to the same scale, as shown below.

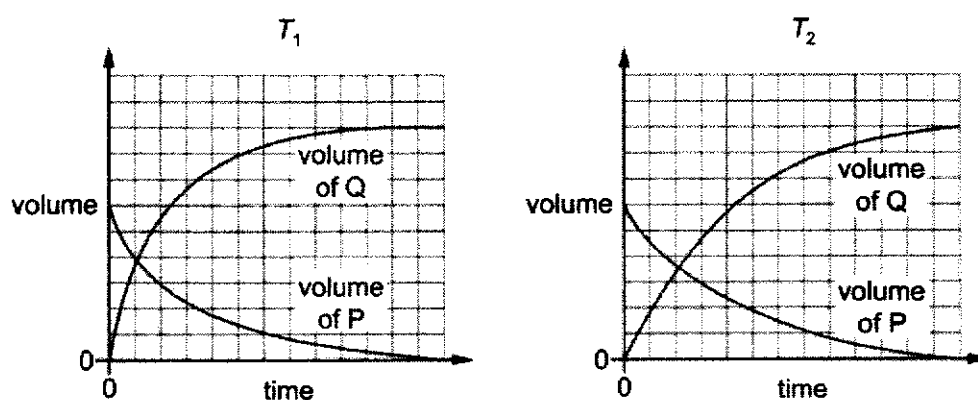

Which row is correct?

	x	y	temperature
A	2	3	$T_1$ is higher than $T_2$ .
B	2	3	$T_2$ is higher than $T_1$ .
C	3	2	$T_1$ is higher than $T_2$ .
D	3	2	$T_2$ is higher than $T_1$ .

30 When an excess of iron(II) carbonate reacts with dilute hydrochloric acid, the reaction gradually becomes slower and finally stops.

Which statement correctly explains why this happened?

- A The iron(II) carbonate is covered by bubbles of carbon dioxide.
- B An insoluble layer of iron(II) chloride is formed.
- C The iron(II) carbonate is completely used up in the reaction.
- D The hydrochloric acid is completely used up in the reaction.

[Turn over

31 In which reaction is the pressure least likely to affect the rate of reaction?

- A  $C(s) + CO_2(g) \longrightarrow 2CO(g)$   
 B  $2SO_2(g) + O_2(g) \longrightarrow 2SO_3(g)$   
 C  $N_2(g) + 3H_2(g) \longrightarrow 2NH_3(g)$   
 D  $NaOH(aq) + HCl(aq) \longrightarrow NaCl(aq) + H_2O(l)$

32 The equation for an industrial process is shown below.

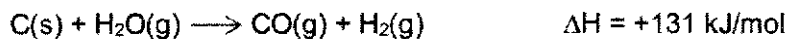

Which row is correct?

	oxidising agent	reducing agent	type of reaction
<b>A</b>	C	H <sub>2</sub> O	endothermic
<b>B</b>	C	H <sub>2</sub> O	exothermic
<b>C</b>	H <sub>2</sub> O	C	endothermic
<b>D</b>	H <sub>2</sub> O	C	exothermic

33 Lithium chloride is dissolved in deionised water, and a few drops of Universal Indicator is added to the solution.

What is the colour of the Universal Indicator in the resulting solution?

- A blue  
 B green  
 C purple  
 D red

34 Metal Y reacts with steam but **not** with cold water.

What is Y?

- A calcium  
 B copper  
 C sodium  
 D zinc

35 Which substance is **not** an essential raw material in the extraction of iron in a blast furnace?

- A air  
 B coke  
 C limestone  
 D sand

[Turn over

- 36 Iodine, I, has a lower relative atomic mass than tellurium, Te, but is placed after it in the Periodic Table.

Which statement explains why iodine is placed after tellurium in the Periodic Table?

- A Iodine has fewer neutrons than tellurium.  
 B Iodine has fewer protons than tellurium.  
 C Iodine has more neutrons than tellurium.  
 D Iodine has more protons than tellurium.
- 37 Methane burns in an excess of oxygen. The equation is shown below.

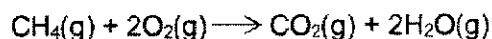

The bond energies are shown in the table.

bond	bond energy in kJ / mol
C – H	+410
C = O	+805
O – H	+460
O = O	+496

What is the energy change for the reaction?

- A +818 kJ / mol  
 B +102 kJ / mol  
 C – 359 kJ / mol  
 D – 818 kJ / mol
- 38 Which metal carbonate is the most thermally stable?
- A calcium carbonate  
 B copper(II) carbonate  
 C lead(II) carbonate  
 D zinc carbonate

[Turn over

- 39 1.0 g of each of the metals calcium, iron, magnesium and zinc was placed in separate test-tubes, each containing excess dilute hydrochloric acid.

The gas evolved from each test-tube was collected and its volume was measured.

Which metal produced the greatest volume of gas on completion of the reaction?

- A calcium  
 B magnesium  
 C iron  
 D zinc
- 40 Oxides of nitrogen, such as NO and NO<sub>2</sub>, are formed in the petrol engines of cars. They are removed from the exhaust gases by reactions in the car's catalytic converter.

Which row describes how oxides of nitrogen are formed in a petrol engine, and a reaction that happens in the catalytic converter?

	how oxides of nitrogen are formed	a reaction that happens in the catalytic converter
A	by the reaction between nitrogen and oxygen from the air	$2\text{NO} + 2\text{CO} \longrightarrow \text{N}_2 + 2\text{CO}_2$
B	by the reaction between nitrogen and oxygen from the air	$2\text{NO} + 2\text{H}_2 \longrightarrow \text{N}_2 + 2\text{H}_2\text{O}$
C	by the reaction between nitrogen compounds in petrol and oxygen from the air	$2\text{NO} + 2\text{CO} \longrightarrow \text{N}_2 + 2\text{CO}_2$
D	by the reaction between nitrogen compounds in petrol and oxygen from the air	$2\text{NO} + 2\text{H}_2 \longrightarrow \text{N}_2 + 2\text{H}_2\text{O}$

END OF PAPER

[Turn over

# The Periodic Table of Elements

		Group																			
I	II	III	IV	V	VI	VII	0														
3 Li lithium 7	4 Be beryllium 9	11 Na sodium 23	12 Mg magnesium 24	19 K potassium 39	20 Ca calcium 40	21 Sc scandium 45	22 Ti titanium 48	23 V vanadium 51	24 Cr chromium 52	25 Mn manganese 55	26 Fe iron 56	27 Co cobalt 59	28 Ni nickel 59	29 Cu copper 64	30 Zn zinc 65	31 Ga gallium 70	32 Ge germanium 73	33 As arsenic 75	34 Se selenium 79	35 Br bromine 80	36 Kr krypton 84
37 Rb rubidium 85	38 Sr strontium 88	39 Y yttrium 89	40 Zr zirconium 91	41 Nb niobium 93	42 Mo molybdenum 96	43 Tc technetium 101	44 Ru ruthenium 101	45 Rh rhodium 103	46 Pd palladium 106	47 Ag silver 108	48 Cd cadmium 112	49 In indium 115	50 Sn tin 119	51 Sb antimony 122	52 Te tellurium 128	53 I iodine 127	54 Xe xenon 131	55 Cs caesium 133	56 Ba barium 137	57-71 lanthanoids	86 Rn radon 222
87 Fr francium -	88 Ra radium -	89-103 actinoids	72 Hf hafnium 178	73 Ta tantalum 181	74 W tungsten 184	75 Re rhenium 186	76 Os osmium 190	77 Ir iridium 192	78 Pt platinum 195	79 Au gold 197	80 Hg mercury 201	81 Tl thallium 204	82 Pb lead 207	83 Bi bismuth 209	84 Po polonium -	85 At astatine -	86 Rn radon -	116 Lv livermorium -	117 Ts tennessine -	118 Og oganesson -	119 Uu unbinilium -

1  
H  
hydrogen  
1

**Key**  
proton (atomic) number  
atomic symbol  
name  
relative atomic mass

57 La lanthanum 139	58 Ce cerium 140	59 Pr praseodymium 141	60 Nd neodymium 144	61 Pm promethium -	62 Sm samarium 150	63 Eu europium 152	64 Gd gadolinium 157	65 Tb terbium 159	66 Dy dysprosium 163	67 Ho holmium 165	68 Er erbium 167	69 Tm thulium 169	70 Yb ytterbium 173	71 Lu lutetium 175
89 Ac actinium -	90 Th thorium 232	91 Pa protactinium 231	92 U uranium 238	93 Np neptunium -	94 Pu plutonium -	95 Am americium -	96 Cm curium -	97 Bk berkelium -	98 Cf californium -	99 Es einsteinium -	100 Fm fermium -	101 Md mendelevium -	102 No nobelium -	103 Lr lawrencium -

lanthanoids

actinoids

Volume of one mole of any gas is 24 dm<sup>3</sup> at room temperature and pressure (r.t.p.).

Name and Index Number:

Class:



## SENG KANG SECONDARY SCHOOL PRELIMINARY EXAMINATION

**CHEMISTRY**

**6092/02**

**Secondary 4 Express**

**27 August 2020**

Paper 2 Theory

**1 hour 45 minutes**

Candidates answer on the Question Paper.

No Additional Materials are required.

### READ THESE INSTRUCTIONS FIRST

Write your index number and name on all the work you hand in.

Write in dark blue or black pen on both sides of the paper.

You may use a soft pencil for any diagrams, graphs or rough working.

Do not use staples, paper clips, highlighters, glue or correction fluid.

#### Section A

Answer all questions in the spaces provided.

#### Section B

Answer all **three** questions, the last question is in the form either/or.

At the end of the examination, fasten all your work securely together.

The number of marks is given in brackets [ ] at the end of each question or part question.

A copy of the Periodic Table is printed on page 23.

The use of an approved scientific calculator is expected, where appropriate.

For Examiner's use	
<b>Section A</b>	<b>/ 50</b>
<b>1</b>	<b>/ 6</b>
<b>2</b>	<b>/ 7</b>
<b>3</b>	<b>/ 10</b>
<b>4</b>	<b>/ 8</b>
<b>5</b>	<b>/ 12</b>
<b>6</b>	<b>/ 7</b>
<b>Section B</b>	<b>/ 30</b>
<b>7</b>	<b>/ 12</b>
<b>8</b>	<b>/ 8</b>
<b>9 E</b>	<b>/ 10</b>
<b>9 OR</b>	<b>/ 10</b>
<b>Total</b>	<b>/ 80</b>
<b>Total %</b>	<b>/ 100</b>

Parent's / Guardian's Signature: .....

This document consists of **22** printed pages and **2** blank pages.

**Do not turn over the page until you are told to do so.**

[Turn over

## Section A

Answer **all** the questions in this section in the spaces provided.

- 1 Fig. 1.1 shows an experiment that was set up to investigate the movement of gaseous ammonia and gaseous hydrogen chloride.

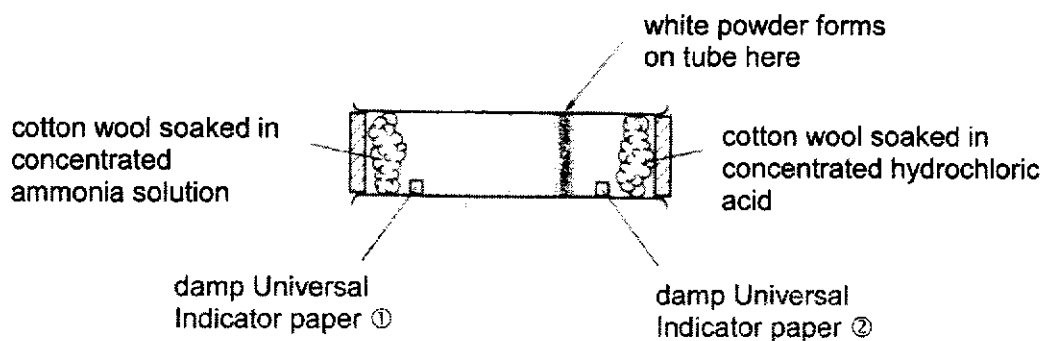

Fig. 1.1

- (a) The white powder forms on the tube is due to the reaction between gaseous ammonia and gaseous hydrogen chloride to make solid ammonium chloride.

**Insert** the correct symbol in the equation to show that this reaction is reversible.



- (b) The tube contains two pieces of Universal Indicator paper.

Complete Table 1.2 to show the colours and pH values of each piece of paper at the end of the experiment.

Table 1.2

Universal Indicator paper	colour	pH
1		
2		

[2]

- (c) Explain why the white powder does **not** form in the centre of the tube.

.....

.....

.....

[3]

[ Total: 6 ]

[Turn over



2 Fig. 2.1 shows part of the Periodic Table.

					He
B	C	N	O	F	Ne
Al	Si	P	S	Cl	Ar
Ga	Ge	As	Se	Br	Kr
				I	Xe

Fig. 2.1

Answer the following questions using only the elements shown in Fig. 2.1. Each element may be used once, more than once or not at all.

(a) Which element is commonly used to fill light bulbs?

..... [1]

(b) Which element is a light yellow-green gas that is commonly used to disinfect swimming pools?

..... [1]

(c) Which element forms an ion which gives a yellow precipitate on addition of aqueous silver nitrate?

..... [1]

(d) Which element has 3 electron shells and 6 valence electrons?

..... [1]

(e) Which elements form a stable ion of type  $X^{3+}$ ?

..... [1]

(f) Which elements are diatomic gases at room temperature?

..... [2]

[Total: 7]

[Turn over

3 Silicon is an element in the Periodic Table.

(a) One of the isotopes of silicon has the nuclide symbol  ${}_{14}^{30}\text{Si}$ .

Deduce the number of electrons, neutrons and protons in one atom of this isotope of silicon.

number of electrons	number of protons	number of neutrons

[1]

(b) Silicon reacts with nitrogen when heated to produce silicon nitride,  $\text{Si}_3\text{N}_4$ .  
Construct the chemical equation for this reaction.

.....

[1]

(c) Silicon dioxide, also known as silica, is an oxide of silicon with the chemical formula  $\text{SiO}_2$ , most commonly found in nature as quartz and in various living organisms. In many parts of the world, silica is the major constituent of sand.

The structure of silicon dioxide is shown in Fig. 3.1.

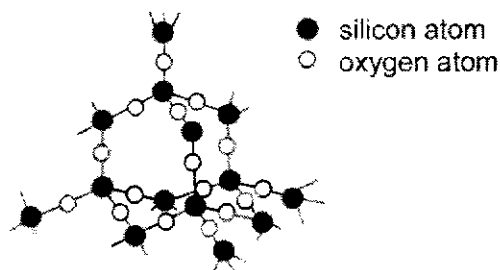

Fig. 3.1

Describe **two** similarities in the structures of silicon dioxide and diamond.

1 .....

.....

2 .....

.....

[2]

[Turn over

- (d) The structure of another compound of silicon is shown in Fig. 3.2.

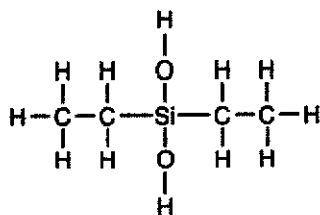

Fig. 3.2

Deduce the type of bonding that is present in this compound.

..... [1]

- (e) (i) Draw a 'dot-and-cross' diagram for a silicon(IV) chloride molecule,  $\text{SiCl}_4$ . You only need to show the outer shell electrons.

[2]

- (ii) Silicon(IV) chloride has a melting point of  $-70^\circ\text{C}$  and a boiling point of  $59^\circ\text{C}$ .

What is the physical state of silicon(IV) chloride at room temperature?

..... [1]

- (iii) Explain the difference in the melting points of silicon dioxide and silicon(IV) chloride. Refer to the structures of silicon dioxide and silicon(IV) chloride in your answer.

.....  
 .....  
 .....

..... [2]

[Total: 10]

[Turn over

4 Aspirin is a medicine that is used as a painkiller. It is made from salicylic acid.

(a) A student makes a sample of aspirin. He thinks it contains some impurities.

(i) The student tests the melting point of his sample of aspirin.

Explain how he can use the result of the test to find out whether his sample contains impurities.

.....

.....

.....

[2]

(ii) The student uses chromatography to produce a chromatogram. He uses his own aspirin and pure samples of aspirin and salicylic acid. Fig. 4.1 shows his chromatogram.

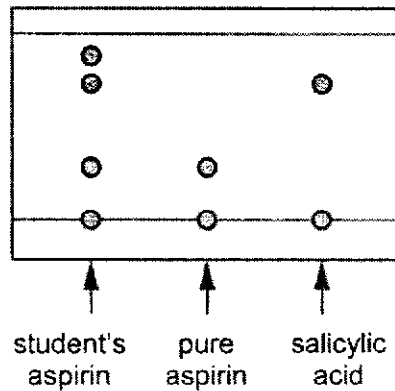

Fig. 4.1

What information does the chromatogram give about the purity of the student's aspirin?

.....

.....

.....

[2]

(b) Aspirin is a *weak acid*.

Explain what is meant by the term *weak acid*.

.....

[1]

[Turn over

- (c) The student buys and tests some tablets that contain aspirin. He performs a titration using a crushed tablet and aqueous sodium hydroxide as shown in Fig. 4.2.

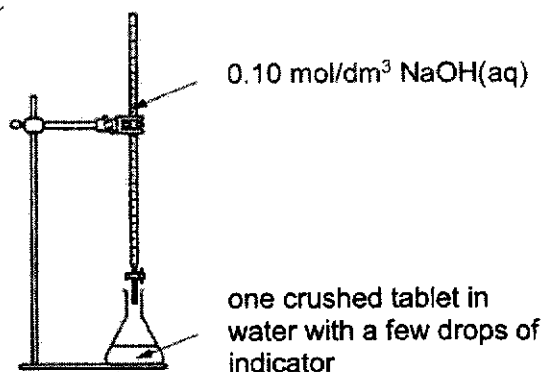

Fig. 4.2

The formula for aspirin can be represented as  $\text{C}_6\text{H}_4(\text{COOH})_2$ . The equation for the reaction between aspirin and aqueous sodium hydroxide is shown below.

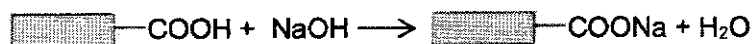

Table 4.3 shows the results of the student's titration.

Table 4.3

concentration of aqueous sodium hydroxide used	0.10 mol/dm <sup>3</sup>
volume of aqueous sodium hydroxide needed for neutralisation	16.70 cm <sup>3</sup>
relative molecular mass of aspirin	180

The label on the bottle of tablets states that each tablet contains 300 mg of aspirin. (1000 mg = 1g)

Do the student's results agree with this value? Show your working clearly.

[3]

[Total: 8]

[Turn over

- 5 Table 5.1 shows the colours of manganese in different oxidation states.

**Table 5.1**

ion / substance	colour	oxidation state of manganese
$\text{MnO}_4^-$	purple	
$\text{Mn}^{2+}$	light pink	+2
$\text{MnO}_4^{2-}$	green	
$\text{MnO}_2$	black	

- (a) Fill in the missing oxidation states of manganese in Table 5.1. [3]

- (b) When solid manganese(II) nitrate,  $\text{Mn}(\text{NO}_3)_2$ , is heated, the products are solid manganese(IV) oxide,  $\text{MnO}_2$ , and brown gas nitrogen dioxide,  $\text{NO}_2$ .

- (i) Construct a chemical equation, with state symbols, for the thermal decomposition of manganese(II) nitrate.

..... [2]

- (ii) Using the changes in oxidation states, explain whether manganese(II) nitrate is oxidised or reduced in the reaction.

..... [2]

- (c) Sally went on a field trip and she found some sea shells at the sea shore which has some purple markings on their inner surfaces. The inner surfaces were scraped and the scrapings were heated gently and turned black. The substance was suspected to be manganese(IV) oxide.

Some reactions of manganese(IV) oxide are set up in the reaction scheme below.

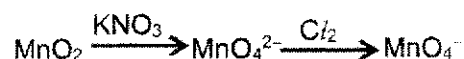

- (i) What is the role of aqueous chlorine?

..... [1]

[Turn over

- (ii) What colour change is observed when aqueous chlorine is added to a solution with  $\text{MnO}_4^{2-}$ ?

..... [1]

- (d) Nitric acid is a strong oxidising agent.  
State and explain which of the following compounds is **least** likely to be produced when dilute nitric acid reacts with a strong reducing agent such as calcium metal.

$\text{N}_2\text{O}$ ,  $\text{NO}$ ,  $\text{NO}_2$ ,  $\text{N}_2\text{O}_4$ ,  $\text{N}_2\text{O}_5$

.....  
.....  
.....  
..... [3]

[Total: 12]

[Turn over

- 6 (a) Complete Table 6.1 by stating whether the overall enthalpy change is positive or negative.

Table 6.1

description	overall enthalpy change (kJ / mol)
(i) $\text{CO}_2(\text{s}) \longrightarrow \text{CO}_2(\text{g})$	
(ii) $\text{Na}_2\text{CO}_3(\text{s}) + 10\text{H}_2\text{O}(\text{l}) \longrightarrow \text{Na}_2\text{CO}_3 \cdot 10\text{H}_2\text{O}(\text{s})$	

[2]

- (b) Hydrogen does **not** react with chlorine in the dark. However, a gaseous mixture of hydrogen and chlorine reacts explosively when exposed to UV light to form fumes of hydrogen chloride.

Complete the energy profile diagram for the reaction of hydrogen and chlorine in the presence of UV light.

Your diagram should include

- the reactants and products,
- a label for the reaction enthalpy change,
- a label for the activation energy.

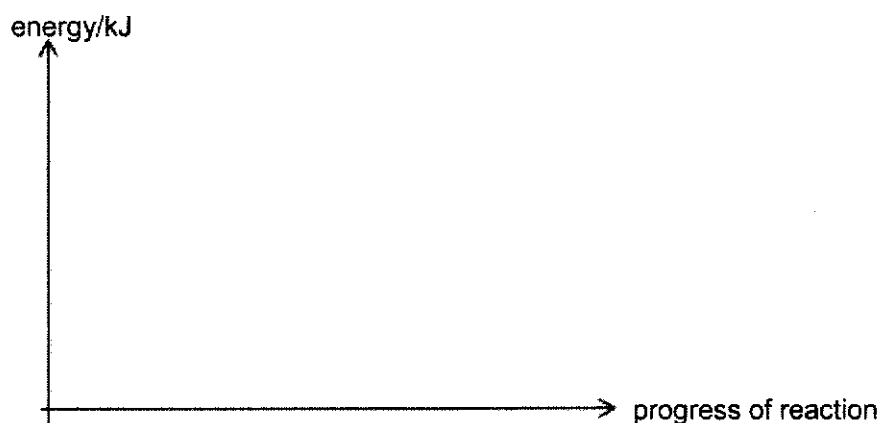

[2]

[Turn over



- (c) A student measured the temperature change when 4.0 g of potassium chloride was dissolved in excess water.

Table 6.2 shows her results.

**Table 6.2**

<b>initial temperature / °C</b>	20
<b>final temperature / °C</b>	12
<b>calculated energy change / J</b>	+720

Use the student's results to calculate the enthalpy change when one mole of potassium chloride dissolves in excess water.

Give your answers in kJ / mol, correct to 3 significant figures.

enthalpy change = ..... kJ / mol [3]

[Total: 7]

[Turn over

**BLANK PAGE**

**[Turn over**

## Section B

Answer all **three** questions in this section.

The last question is in the form of an either/or and only one of the alternatives should be attempted.

**7 Read the information about the industrial production of oxygen.**

There are many methods used in the industry to produce oxygen. Production cost, purity and volume desired are some of the key factors determining the selection criteria.

The production of oxygen using Pressure Swing Adsorbers (PSA) and electrolysis are simplified in Table 7.1.

**Table 7.1**

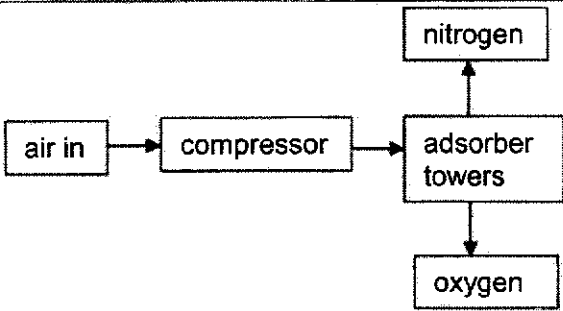
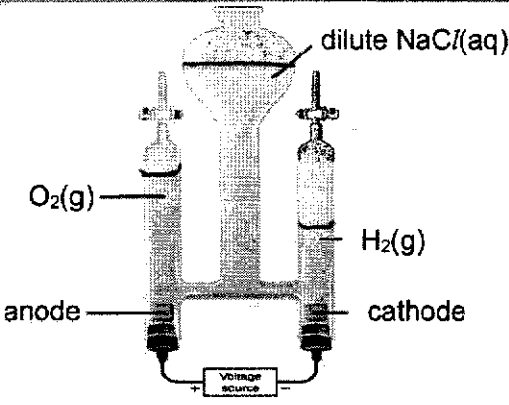
<p><b>Pressure Swing Adsorbers (PSA)</b></p>	 <p>Air is pressurised in the compressor before passing into adsorber towers. In the adsorber towers, nitrogen and oxygen in the air are separated.</p> <p>The substance used in the adsorber towers needs to be replaced or regenerated after a certain volume of air has been separated as it will become saturated with nitrogen.</p>
<p><b>electrolysis</b></p>	 <p>Dilute aqueous sodium chloride is electrolysed to produce oxygen and hydrogen using graphite electrodes. In theory, the ratio of hydrogen gas to oxygen gas collected should be 2:1. As oxygen is more soluble than hydrogen in water, thus the ratio of gases collected will change.</p>

[Turn over

Table 7.2 shows more information about the two methods.

**Table 7.2**

	<b>Pressure Swing Adsorbers (PSA)</b>	<b>Electrolysis</b>
<b>overall energy consumption (kWh per m<sup>3</sup> of O<sub>2</sub>)</b> 1 m <sup>3</sup> = 1000 dm <sup>3</sup>	0.5	10
<b>purity of O<sub>2</sub> produced</b>	less than 95% (more than 99.9% can only be achieved with extremely expensive high-end device)	more than 99.9%
<b>by-product</b>	impure nitrogen is produced	produced hydrogen which can be used as a fuel

- (a) Other than lower purity, state **two** disadvantages of producing oxygen using the PSA method.

1 .....

.....

2 .....

.....

[2]

- (b) Explain why the theoretical volume ratio of hydrogen to oxygen produced in electrolysis is 2:1. Include appropriate equation in your answer.

.....

.....

.....

.....

[2]

[Turn over

- (c) State and explain how would the **final** volume of oxygen and hydrogen collected in electrolysis change due to the difference in solubility of the two gases in water.

.....  
.....  
.....  
.....

[2]

- (d) Calculate the energy consumption using electrolysis per mole of oxygen gas produced.

.....  
.....  
.....  
.....

[2]

- (e) What happens to the concentration of sodium chloride during the electrolysis? Explain your reasoning.

.....  
.....  
.....

[1]

- (f) The electrolyte used in the electrolysis needs to be replaced regularly. Explain why the electrolyte needs to be replaced regularly. Justify your answer with relevant equations explaining the reaction that occurred at each electrode.

.....  
.....  
.....

[3]

[Total: 12]

[Turn over

8 A group of students were investigating the effects of "acid rain". They decided to look at the effect of acid on metals used as building materials. Lead and copper are common materials for roofing, iron and aluminium are common materials for window frames.

The students proceeded to test the four metals by adding dilute sulfuric acid to pieces of each metal to simulate the effects of "acid rain" on the metals. It is found that only the iron pieces seemed to have a positive reaction with the acid, and effervescence was observed.

(a) Arrange the four metals in descending order of reactivity.

..... [1]

(b) Explain why aluminium did **not** seem to react with the acid in the experiment to produce a gas.

.....  
..... [1]

(c) As dilute sulfuric acid was used in the experiment, there were no reactions for both lead and copper. However, it cannot be concluded that one metal is more reactive than the other.

(i) Explain why the students **cannot** prove the reactivity of lead and copper using dilute sulfuric acid.

.....  
.....  
.....  
..... [2]

(ii) Briefly describe an experiment that the students can carry out to show the difference in the reactivity of lead and copper.

.....  
.....  
..... [2]

[Turn over

- (d) Steel articles can be electroplated with tin or zinc to prevent rusting. It is observed that when the zinc layer is damaged and exposed the underlying steel, the steel does not rust; but when the tin layer is broken, the underlying steel rusts.

Explain the observation above.

.....

.....

.....

.....

[2]

[Total: 8]

[Turn over

EITHER

9 (a) Halogens are elements in Group VII of the Periodic Table.

An experiment to determine the reactivity of the four unknown halogens was carried out. Each of the unknown halogen,  $W_2$ ,  $X_2$ ,  $Y_2$  and  $Z_2$  was added separately to aqueous solution containing other halide ions.

Table 9.1 shows the results for the various reactions.

Table 9.1

halogen	aqueous sodium halide solution			
	NaW	NaX	NaY	NaZ
$W_2$		✓	X	✓
$X_2$	X		X	X
$Y_2$	✓	✓		✓
$Z_2$	X	✓	X	

key

✓ reaction has occurred

X no reaction

 reaction was not carried out

(i) Going down the Group, state the trend in the colour and boiling point of Group VII elements.

colour .....

boiling point ..... [1]

(ii) Based on the results, arrange the four halogens in ascending reactivity.

..... [1]

(iii) Construct an ionic equation for the reaction between  $W_2$  and  $NaZ$ .  
Explain the reaction that occurs.

ionic equation .....

explanation .....

..... [2]

[Turn over



- (b) When tin reacts with bromine, a yellow solid product was formed. Upon analysis of a 28.3 g sample of the product, it was found to contain 12.1 g tin.

Calculate the empirical formula of the product.

empirical formula is ..... [3]

- (c) The electrolysis of molten magnesium bromide using graphite electrodes was carried out as shown in Fig. 9.2.

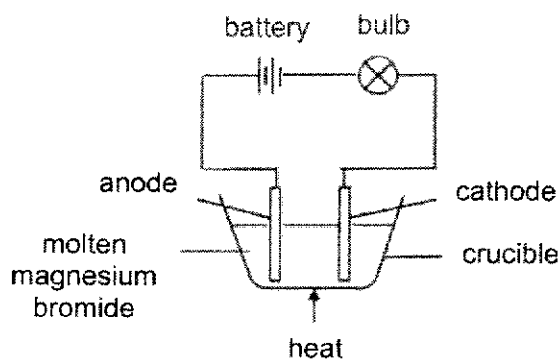

Fig. 9.2

- (i) On Fig. 9.2, indicate the direction of the electron flow in the cell. [1]
- (ii) What are the observations made during the electrolysis of molten magnesium bromide?

.....

..... [2]

[Total: 10]

[Turn over

OR

9 Johnson read an article featured in a newspaper recently. It is about increasing global temperatures due to global warming and grounding planes at the airport. The article is shown in Fig. 9.1

**How higher temperatures affect flying**

As temperatures increase, air density decreases, which reduces lift and makes it harder for airplanes to take off. To address this, airlines could reduce weight (by loading fewer passengers and less fuel or cargo) or schedule departures for cooler periods of the day.

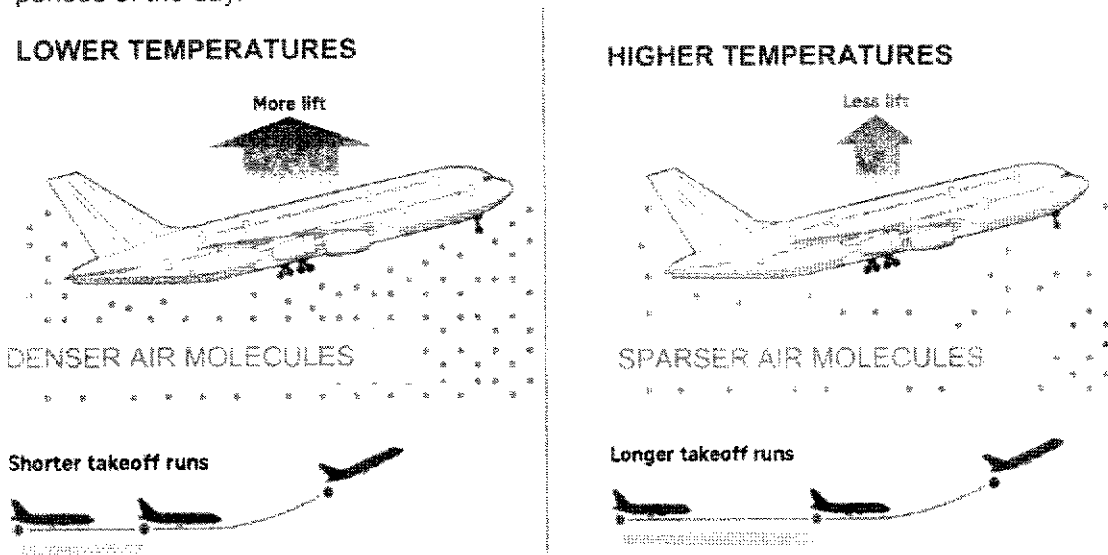

Fig. 9.1

(a) Johnson explained that an increase in temperature caused the air molecules to disintegrate leading to fewer molecules per unit volume. His explanation is wrong.

Explain, using Kinetic Particle Theory,

(i) the correct reason for the sparser air molecules at higher temperatures,

.....  
..... [1]

(ii) how cooler periods of the day allow more lift for the airplane to take off.

.....  
..... [1]

[Turn over

- (b) One other way of reducing airplane weight is to use carbon fibre (or graphite fibre) to make the wings, as the material could be moulded into a desirable shape.

Explain, using your knowledge of chemical structure, why graphite can be easily moulded.

.....

.....

.....

.....

[3]

- (c) Environmental groups think that the shrinking of the ice caps is the result of global warming. Satellite images from September 1979 and 2007 are used to show the area of the Arctic sea ice as shown in Fig. 9.2.

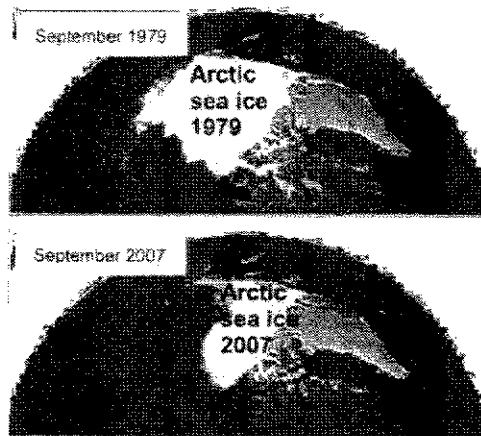

Fig. 9.2

- (i) State **one** consequence of the reduction of Arctic sea ice.

.....

.....

[2]

- (ii) Describe **one** possible source of global warming that led to the reduction of Arctic sea ice.

.....

.....

[1]

[Turn over

- (iii) Scientists are currently developing a process called Carbon Capture and Storage (CCS). This will reduce the problem of global warming. There are three main steps to CCS. Firstly, carbon dioxide is trapped and separated from other gases produced in a coal-powered electricity plants. The captured carbon dioxide is transported to a storage location. The carbon dioxide is then stored far away from the atmosphere (underground or deep in the ocean).

Use the information given to suggest **one** reason why some scientists do **not** support the use of CCS.

.....

.....

.....

.....

[2]

[Total: 10]

**END OF PAPER**

[Turn over

# The Periodic Table of Elements

		Group																																																																															
I	II	III	IV	V	VI	VII	0					0																																																																					
3 Li lithium 7	4 Be beryllium 9	11 Na sodium 23	12 Mg magnesium 24	13 Al aluminium 27	14 Si silicon 28	15 P phosphorus 31	16 S sulfur 32	17 Cl chlorine 35.5	18 Ar argon 40	19 K potassium 39	20 Ca calcium 40	21 Sc scandium 45	22 Ti titanium 48	23 V vanadium 51	24 Cr chromium 52	25 Mn manganese 55	26 Fe iron 56	27 Co cobalt 59	28 Ni nickel 59	29 Cu copper 64	30 Zn zinc 65	31 Ga gallium 70	32 Ge germanium 73	33 As arsenic 75	34 Se selenium 79	35 Br bromine 80	36 Kr krypton 84	37 Rb rubidium 85	38 Sr strontium 88	39 Y yttrium 89	40 Zr zirconium 91	41 Nb niobium 93	42 Mo molybdenum 96	43 Tc technetium -	44 Ru ruthenium 101	45 Rh rhodium 103	46 Pd palladium 106	47 Ag silver 108	48 Cd cadmium 112	49 In indium 115	50 Sn tin 119	51 Sb antimony 122	52 Te tellurium 128	53 I iodine 127	54 Xe xenon 131	55 Cs caesium 133	56 Ba barium 137	57-71 lanthanoids	72 Hf hafnium 178	73 Ta tantalum 181	74 W tungsten 184	75 Re rhenium 186	76 Os osmium 190	77 Ir iridium 192	78 Pt platinum 195	79 Au gold 197	80 Hg mercury 201	81 Tl thallium 204	82 Pb lead 207	83 Bi bismuth 209	84 Po polonium -	85 At astatine -	86 Rn radon -	87 Fr francium -	88 Ra radium -	89-103 actinoids	104 Rf rutherfordium -	105 Db dubnium -	106 Sg seaborgium -	107 Bh bohrium -	108 Hs hassium -	109 Mt meitnerium -	110 Ds darmstadtium -	111 Rg roentgenium -	112 Cn copernicium -	113 Nh nihonium -	114 Fl flerovium -	115 Lv livermorium -	116 Ts tennessine -	117 Oh oganeson -	118 Og ogesson -

**Key**  
 proton (atomic) number  
 atomic symbol  
 name  
 relative atomic mass

1  
H  
hydrogen  
1

57 La lanthanum 139	58 Ce cerium 140	59 Pr praseodymium 141	60 Nd neodymium 144	61 Pm promethium -	62 Sm samarium 150	63 Eu europium 152	64 Gd gadolinium 157	65 Tb terbium 159	66 Dy dysprosium 163	67 Ho holmium 165	68 Er erbium 167	69 Tm thulium 169	70 Yb ytterbium 173	71 Lu lutetium 175
89 Ac actinium -	90 Th thorium 232	91 Pa protactinium 231	92 U uranium 238	93 Np neptunium -	94 Pu plutonium -	95 Am americium -	96 Cm curium -	97 Bk berkelium -	98 Cf californium -	99 Es einsteinium -	100 Fm fermium -	101 Md mendelevium -	102 No nobelium -	103 Lr lawrencium -

lanthanoids

actinoids

The volume of one mole of any gas is 24 dm<sup>3</sup> at room temperature and pressure (r.t.p.).

**BLANK PAGE**

4E Pure SKSS Chemistry Preliminary Exam 2020 Paper 1– Answers

1	D
2	B
3	A
4	C
5	B
6	D
7	A
8	A
9	B
10	D

11	D
12	D
13	C
14	B
15	C
16	B
17	D
18	B
19	A
20	B

21	A
22	D
23	C
24	B
25	D
26	A
27	C
28	A
29	A
30	D

31	D
32	C
33	B
34	D
35	D
36	D
37	D
38	A
39	B
40	A

4E Pure SKSS Chemistry Preliminary Exam 2020 Paper 2-- Answers

- 1 (a) Insert the missing symbol  $\rightleftharpoons$  (no mark if the symbol is inverted) 1
- (b)
- | Universal Indicator paper | colour | pH             |
|---------------------------|--------|----------------|
| 1                         | blue   | accept 10 - 12 |
| 2                         | red    | accept 1 - 2   |
- Each row  
1m  
Max 2
- (c) Ammonia (NH<sub>3</sub>), being lighter / of lower molecular mass than hydrogen chloride (HCl), will diffuse faster and over a longer distance than hydrogen chloride. Hence the white powder will not form in the centre of the tube.  
(no mark if "travel" / "move" is written instead of diffuse) 1m for each underlined word  
Max 3
- 2 (a) Ar (b) Cl (c) I (d) S 4
- (e) Al and Ga 1
- (f) N, O, F, Cl Note: If students write more than 4 answers, max of 1 mark will be given 1m for 2 correct  
Max 2
- Note: For whole of Q2 - Accept answers if students spell the names of the elements correctly.
- 3 (a) 14 14 16 1
- (b)  $3\text{Si} + 2\text{N}_2 \rightarrow \text{Si}_3\text{N}_4$  1
- (c) Any 2 of the following: 2
- Both have covalent bonds
  - Both have giant covalent (molecular) structure
  - Both have tetrahedral arrangement of structure
- Note: Do NOT accept the following**
- X both are solids
  - X each atom is connected to 4 other atoms
  - X crystal lattice
  - X simple covalent bonds / giant covalent bonds (wrong terminology)
- (d) covalent bonding (no mark for wrong spelling) 1
- (e) (i) pair of shared electrons between each of the 4 Cl atoms and central Si 1  
6 non-bonding electrons around each Cl 1
- (ii) liquid 1
- (iii) Silicon dioxide has a giant covalent (molecular) structure, much heat is required to overcome the strong covalent bonds throughout the structure  
(no mark if students write "to break the bonds" / mention of weak intermolecular forces in silicon dioxide) 1
- Silicon(IV) chloride has a simple covalent (molecular) structure, not much heat is required to overcome the weak intermolecular forces.  
(no mark if students write "weak covalent bonds") 1



- 4 (a) (i) Pure aspirin will have a fixed melting point while impure aspirin will melt over a range of values 1, 1  
**(REJECT:** variable melting points / temperature should be constant)
- (ii) - salicylic acid is an impurity found in student's aspirin sample 1  
- an unknown substance is also present in the student's aspirin sample 1  
**(REJECT :** any mention of dye or spots or dots / unknown impurity)
- (b) Weak acid is partially ionised into hydrogen ions in solution 1  
**(reject:** wrong phrasing "H<sup>+</sup> ions are partially ionised")
- (c) Working to include :  
no. of moles of NaOH = 0.00167 mol 1  
mass of aspirin = 0.00167 x 180 = 0.3006 g = 300.6 mg 1  
student's results agree with given value, within experimental error 1
- 5 (a) +7 , +6, + 4 3
- (b) (i)  $\text{Mn}(\text{NO}_3)_2(\text{s}) \rightarrow \text{MnO}_2(\text{s}) + 2\text{NO}_2(\text{g})$   
correct formula & correctly balanced 1  
all state symbols are correct 1
- (ii) Manganese(II) nitrate is oxidised as there is an increase in the oxidation states from +2 to +4. 1, 1
- (c) (i) oxidising agent / to oxidise MnO<sub>4</sub><sup>2-</sup> to MnO<sub>4</sub><sup>-</sup> 1  
(ii) From green to purple 1
- (d) **N<sub>2</sub>O<sub>5</sub>** 1  
When nitric acid reacts with a reducing agent (calcium), it is reduced and there will be a decrease in the oxidation state of nitrogen. However, the oxidation state of nitrogen remains unchanged at +5 if N<sub>2</sub>O<sub>5</sub> is produced. Hence, it is least likely that N<sub>2</sub>O<sub>5</sub> will be produced. 1  
**(Note:** NO mark will be awarded if students write N<sub>2</sub>O<sub>5</sub> and another substance)

- 6 (a) (i) positive (no mark if students write + ; not following instructions given in Qn) 1  
 (ii) negative (no mark if students write – ; not following instructions given in Qn) 1

(b)

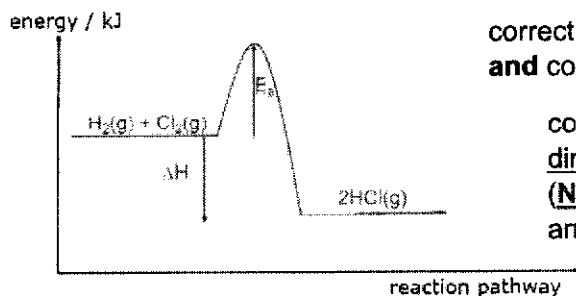

correct labels for reactants & products  
**and** correct energy level

correct labels for  $\Delta H$  and  $E_a$  **and**  
 direction of arrows are correct  
 (NOTE: double-barrelled  
 arrowed are **NOT** accepted)

**NOTE:** If endothermic profile is drawn = zero mark , wrong concept

- (c) Energy change 2  

$$\frac{720 \div 1000}{(4.0 \div (39 + 35.5))}$$

$$= +13.41$$

$$\approx +13.4 \text{ kJ/mol}$$

**NOTE:** no '+' sign  $\rightarrow$  1m is not awarded

- 7 (a) 1 Nitrogen produced is not usable as it is impure / contaminated 1  
 2 The adsorbers need to be replaced regularly and this will increase the cost of production 1  
 (b)  $2\text{H}_2\text{O} \rightarrow 2\text{H}_2 + \text{O}_2$  (no mark if equation is reversed) 1  
 mole ratio of  $\text{H}_2\text{O} : \text{H}_2 = 1 : 1$  **and**  $\text{H}_2\text{O} : \text{O}_2 = 2 : 1$ ; hence infer ratio of  $\text{H}_2 : \text{O}_2 = 2 : 1$  1  
**OR from the equation**, mention that ratio of  $\text{H}_2 : \text{O}_2 = 2 : 1$   
**NOTE:** If two half equations are given, comparison must be based on **4 mol of electrons** before marks are awarded.  
 (c) Volume of oxygen collected will be lower than expected as it is soluble in water 1  
 Volume of hydrogen collected should be the same as it is not soluble in water 1  
 (d)  $\frac{10}{(1000+24)} = 0.240 \text{ kWh}$  [ if no units, only 1 mark will be awarded] 1, 1  
 (e) Concentration of sodium chloride would increase as the water is being electrolysed. 1  
 [Concentration increase alone **without reason** = 0 mark]  
 (f) At anode:  $2\text{Cl}^- - 2\text{e} \rightarrow \text{Cl}_2$  /  $2\text{Cl}^- \rightarrow \text{Cl}_2 + 2\text{e}$  1  
Chloride ions will be discharged at anode to produce chlorine instead of hydroxide ions, hence oxygen will not be produced when the electrolyte becomes concentrated aqueous sodium chloride. 1  
At cathode:  $2\text{H}^+ + 2\text{e} \rightarrow \text{H}_2$  1  
Hydrogen is produced at the cathode

- 8 (a) aluminium, iron, lead, copper 1
- (b) The insoluble oxide layer on aluminium reacts with the acid to form salt and water only, hence no effervescence was observed. 1  
(no mark if students write that the insoluble oxide layer prevents further reactions from occurring)
- (c) (i) Lead reacts sulfuric acid to form an insoluble layer of lead(II) sulfate which prevents lead from further reaction with the acid. 1
- Copper is an unreactive metal and it will not react with the acid to form salt and hydrogen. 1
- (ii) Conduct a metal displacement reaction by dipping a piece of lead metal into copper(II) nitrate solution, and a piece of copper metal into lead(II) nitrate solution. 1  
There will be no visible reaction for copper and lead(II) nitrate solution. However, for lead in copper(II) nitrate solution, red-brown deposits will be observed and blue solution becomes colourless after some time. 1  
This shows that lead is more reactive than copper, and it displaces copper from copper(II) nitrate solution. 1  
(NOTE: general statement "more reactive metal displaces less reactive metal" will NOT be awarded marks)
- (d) Zinc is more reactive than iron / steel, **AND one** of the following statements: 1  
Zinc loses electrons more easily than iron / zinc corrodes instead of iron, 1  
Zinc is oxidised / electrons move from zinc to iron. 1  
(REJECT: Zinc rusted)
- Iron is more reactive than tin, so it will rust instead of tin 1
- 9E (a) (i) colour become darker **AND** boiling point increases / becomes higher 1  
(ii)  $X_2, Z_2, W_2, Y_2$  (REJECT: X, Z, W, Y) 1  
(iii)  $W_2 + 2Z^- \rightarrow Z_2 + 2W^-$  1  
 $W_2$  being more reactive than  $Z_2$ , displaces  $Z_2$  from its solution to form  $NaW$  and  $Z_2$  (no mark :  $W_2$  is higher in the reactivity series than  $Z_2$ ) 1
- (b)  $\frac{12.1}{119} \text{ mol Sn} : \frac{28.3-12.1}{80} \text{ mol Br}$  (no mark if no working) 1  
 $\frac{12.1}{119} \div \frac{12.1}{119} \quad \frac{0.2025}{(12.1+119)}$  (no mark if no working) 1  
Simplest ratio of Sn : Br = 1: 2 1
- NOTE:** Omission of essential working will result in a loss of marks  
Empirical formula is SnBr<sub>2</sub> 1
- (c) (i) Correct direction of electron flow from anode to cathode 1  
(ii) At anode: red-brown vapour / red-brown gas (no mark : bromine) 1  
At cathode: shiny silver (accept grey) liquid (no mark : magnesium) 1  
**NOTE:** correct observation and physical state before mark is awarded

- 9OR (a) (i) At higher temperatures, the gas molecules gain kinetic energy, move faster and further apart from one another, hence resulting in sparser air molecules. 1
- (ii) During cooler periods of the day, the temperature decreases, the molecules lose energy to the surroundings, and slow down in their movement. This causes the molecules to come closer to one another, hence making the air denser. 1
- (b) Graphite has a giant covalent structure, and each carbon atom is only bonded to three other carbon atoms in hexagonal layers. 1
- Not much energy is needed to overcome the weak intermolecular forces between the layers of carbon atoms, and this allow the layers to slide over one another easily, hence making graphite being easily moulded. 1  
1
- (c) (i) massive flooding of low-lying areas leading to destruction of crops / animal habitats 1  
(REJECT: "rise of sea level" alone) 1
- (ii) Increase in emission levels of carbon dioxide + any one of the following: 1  
- increase in usage of carbon-containing fuels  
- deforestation  
- increase in usage of vehicles with petrol engines  
(NOTE: no mark for wrong concept "depletion of ozone level")
- (iii) Answer must be clearly substantiated before mark can be awarded. **Max 2**
- Any one of the following:  
- CCS is expensive as it takes a lot of equipment to capture, purify, liquefy, transport and bury CO<sub>2</sub> [1,1]
- OR**
- Safety concern because it is uncertain what the consequences will be if there is a leakage of large amounts of CO<sub>2</sub> into the atmosphere. CO<sub>2</sub> can be dangerous in large concentrated amounts. [1]  
[1]