



**RAFFLES GIRLS' PRIMARY SCHOOL**

**SEMESTRAL ASSESSMENT 2  
2013**

Your Score	
Out of 100 marks	
Parent's Signature	

Name : \_\_\_\_\_ ( ) Class: P3\_\_

**8 Oct 2013**

**MATHEMATICS**

Att: 1 h 45 min

**SECTION A (40 marks)**

**Question 1 to 20 carry 2 marks each. For each question, four options are given. One of them is the correct answer. Make your choice (1, 2, 3 or 4). Shade the correct oval (1, 2, 3 or 4) on the Optical Answer Sheet (OAS).**

1. 100 less than 8 thousands, 9 hundreds and 5 ones is \_\_\_\_\_.

- (1) 8805
- (2) 8850
- (3) 9005
- (4) 9050

2. Add 3679 to 2404. The answer is \_\_\_\_\_.

- (1) 1275
- (2) 5083
- (3) 6073
- (4) 6083

3. 4 km and 8 m = \_\_\_\_\_ m

- (1) 48
- (2) 408
- (3) 4008
- (4) 4080

4. What is the mass of the ostrich egg?

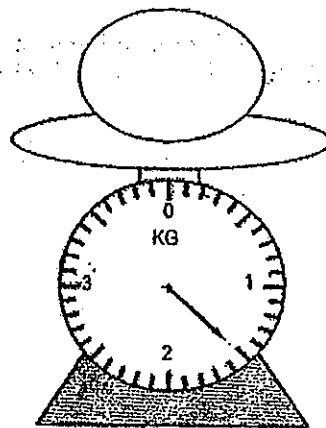

- (1) 1 kg 15 g
- (2) 1 kg ~~50~~ <sup>25</sup>g
- (3) 1 kg 50 g
- (4) 1 kg 500 g

5. What is the total volume of the water in the two beakers?

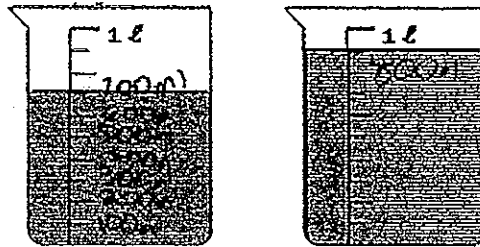

- (1) 800 ml
- (2) 900 ml
- (3) 1 l 60 ml
- (4) 1 l 600 ml

6. What is the amount of money shown below?



- (1) \$17.10
- (2) \$17.60
- (3) \$18.10
- (4) \$18.60

7. Which of the following shows that  $\frac{5}{8}$  of the figure is shaded?

(1)

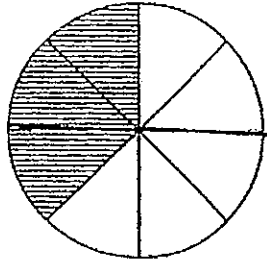

(2)

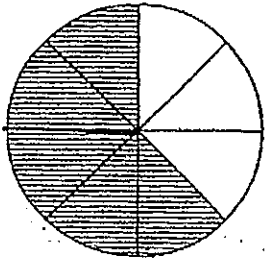

(3)

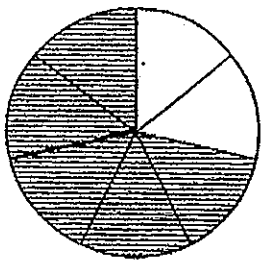

(4)

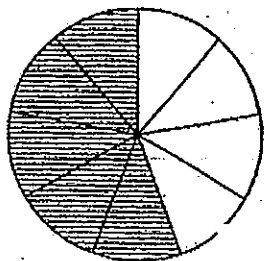

8. Which letter below does not have perpendicular lines?

T H E O

(1) T

(2) H

(3) E

(4) O

9.  $2\text{h } 40\text{ min} = \underline{\hspace{2cm}} \text{ min.}$

(1) 160

(2) 220

(3) 240

(4) 520

10. The shaded figure shown below is made up of identical squares. It is not drawn to scale. Find the perimeter of the shaded figure.

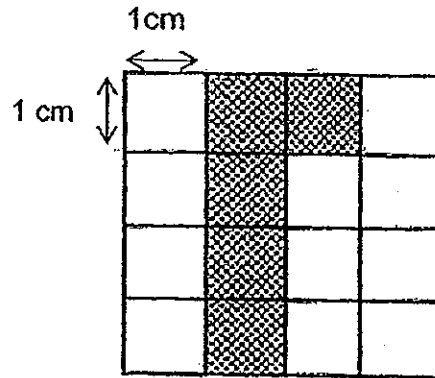

- (1) 10 cm  
(2) 12 cm  
(3) 16 cm  
(4) 20 cm
11. Farmer Lim had 4800 chickens in his farm. He bought 500 more chickens and sold 750 chickens to a restaurant but 30 of them were returned to him. How many chickens did Farmer Lim have on his farm in the end?

- (1) 4550  
(2) 4580  
(3) 5300  
(4) 5330

12. Nana had 5 kg of rice. After a week, 2 kg 30 g of rice was left. How many grams of rice did she use?

- (1) 2700 g
- (2) 2970 g
- (3) 4770 g
- (4) 7030 g

13. Ahmad has the amount of money shown below. He needs \$10 to buy a book. How much more money does he need?



- (1) \$3.70
- (2) \$6.30
- (3) \$6.70
- (4) \$7.30

14. The following graph shows the number of beads each girl has.

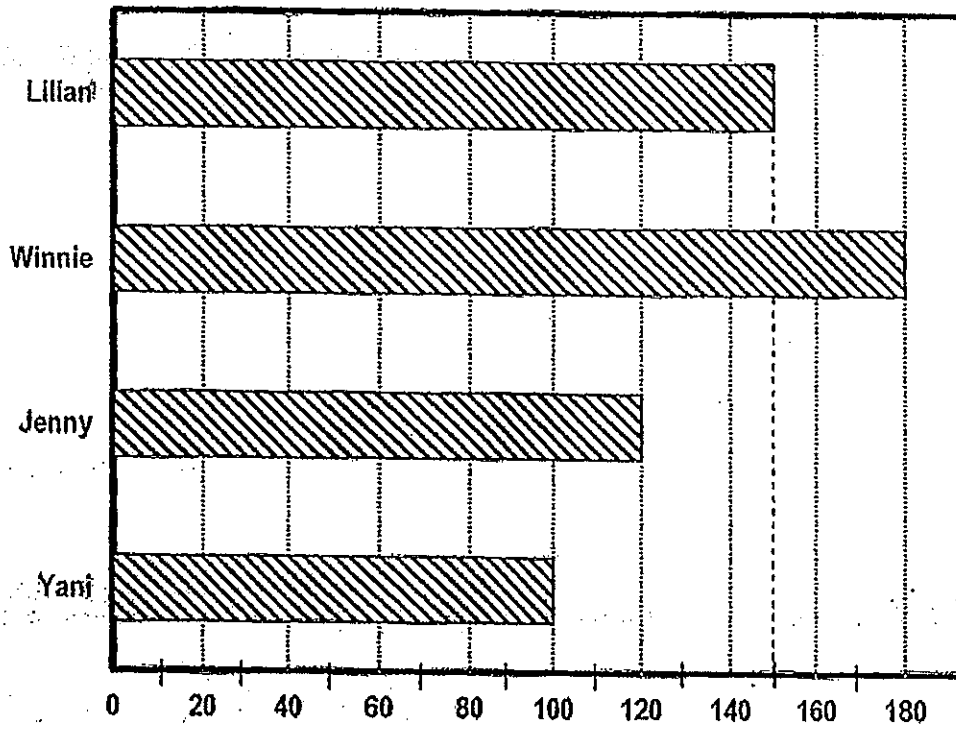

What is the total number of beads Yani and Lillian have?

- (1) 220
- (2) 250
- (3) 280
- (4) 350



15. Which one of the following fraction does not represent the shaded part shown below?

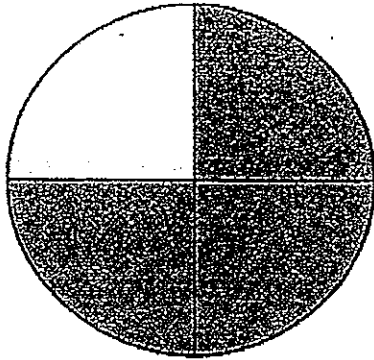

(1)  $\frac{3}{4}$

(2)  $\frac{6}{8}$

(3)  $\frac{6}{12}$

(4)  $\frac{9}{12}$

16. The clock shows the time in the morning. The time shown is slower by 45 minutes.  
What is the actual time?

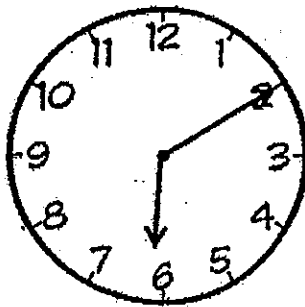

(1) 1.45 a.m.

(2) 3.15 a.m.

(3) 5.25 a.m.

(4) 6.55 a.m.

17. The figure below is made up of 3 identical rectangles and 2 identical squares. It is not drawn to scale. Find the area of the whole figure.

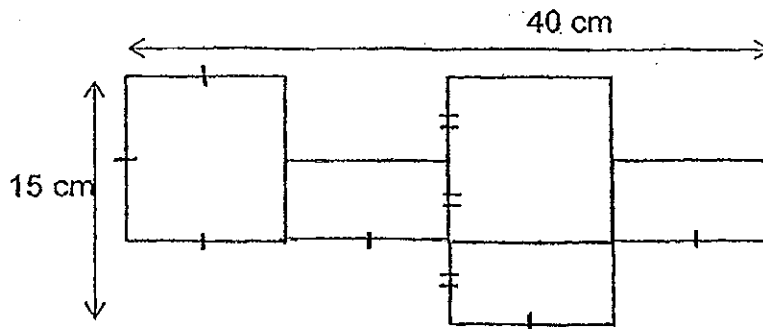

- (1)  $350 \text{ cm}^2$   
(2)  $400 \text{ cm}^2$   
(3)  $450 \text{ cm}^2$   
(4)  $600 \text{ cm}^2$
18. When 6 children shared some marbles equally, each of them got 68 marbles. If these marbles are shared by 2 more children, how many marbles will each child get?

- (1) 34  
(2) 51  
(3) 136  
(4) 204

19. Diana left her house at 12.30 p.m.. She took 10 minutes to walk to the bus stop. She boarded a bus 15 minutes later. She arrived at her destination 1 hour 40 min later.  
At what time did she arrive at her destination?

- (1) 12.40 p.m.
- (2) 12.55 p.m.
- (3) 2.10 p.m.
- (4) 2.35 p.m.

20. Look at the figures below. They are not drawn to scale.  
The perimeter of Figure A is 10 cm less than the perimeter of Figure B. Find the total perimeter of both figures.

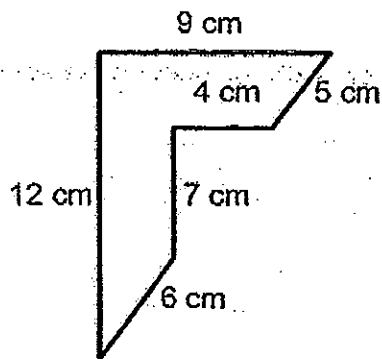

Figure A

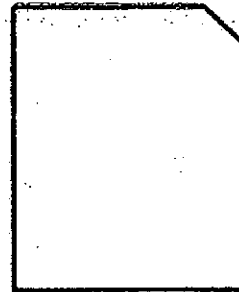

Figure B

- (1) 33 cm
- (2) 43 cm
- (3) 86 cm
- (4) 96 cm

SECTION B (40 marks)

Question 21 to 40 carry 2 marks each. Write your answers in the spaces provided. For questions which require units, give your answers in the units stated. All diagrams are not drawn to scale. Answers in fractions must be expressed in the simplest form. Marks will be awarded for relevant working.

21. In 7406, the digit 4 is in the \_\_\_\_\_ place.

Ans: \_\_\_\_\_

22. Find the value of A and B.

$$\begin{array}{r} 4 \boxed{A} \boxed{B} 8 \\ + 3 \ 6 \ 8 \ 5 \\ \hline 7 \ 9 \ 0 \ 3 \end{array}$$

Ans: A = \_\_\_\_\_

B = \_\_\_\_\_

23. Find the product of 258 and 6.

Ans: \_\_\_\_\_

The graph below shows the favourite fruits of pupils in a school.

Use the information below to answer Questions 24 and 25.

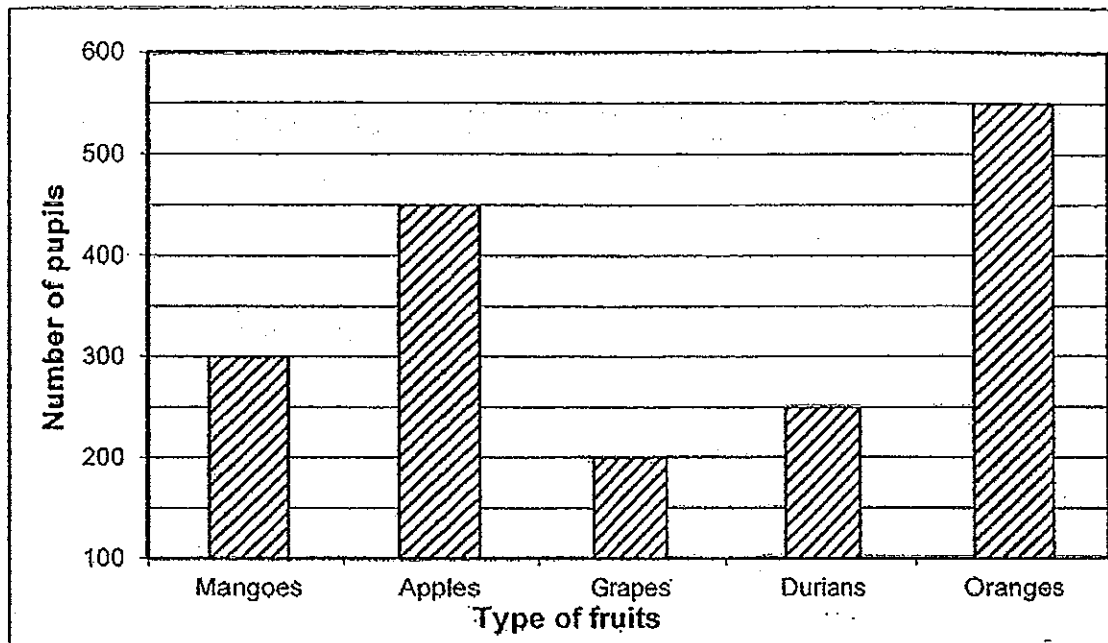

24. What is the pupils' favourite fruit?

Ans: \_\_\_\_\_

25. How many more pupils prefer apples to durians?

Ans: \_\_\_\_\_

26. Draw a line that is parallel to line AB and passing through point T.

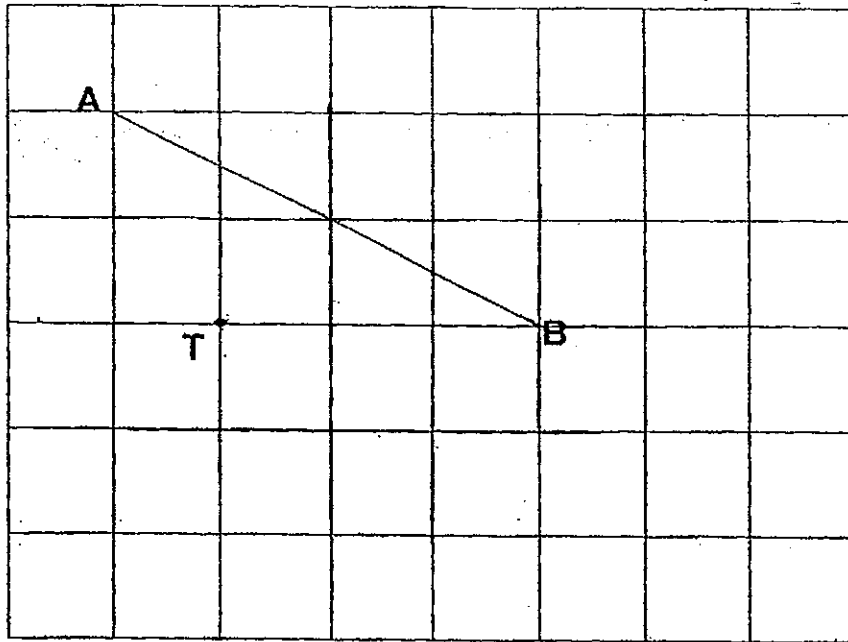

27. The length of a rectangle is 5 cm longer than its breadth. Its breadth is 7 cm. Find its area.



Ans: \_\_\_\_\_ cm<sup>2</sup>

28. What is the greatest 4-digit number that can be formed with the given digits? Write the number in words.

4

0

9

8

Ans: \_\_\_\_\_

29. Tim ran 5 080 m last Sunday. How many kilometres and metres did he run?

Ans: \_\_\_\_\_ km \_\_\_\_\_ m

30. How many millilitres of oil is in the bottle shown below?



Ans: \_\_\_\_\_ ml

31. Find the total mass of the two bags of potatoes.

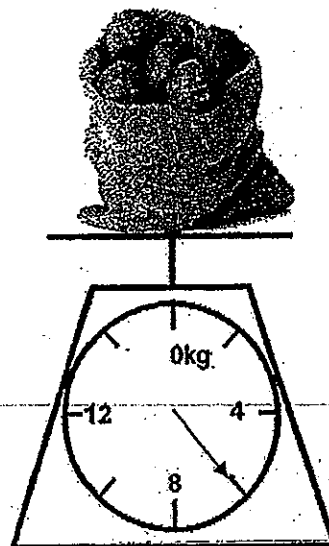
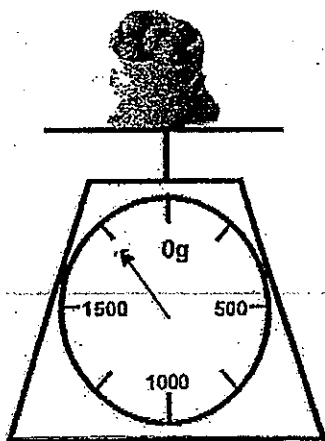

Ans: \_\_\_\_\_ kg \_\_\_\_\_ g

32. Mr Raju bought a motorbike. He paid \$2314 in the first month and \$433 per month for the next 9 months.  
What was the price of the motorbike?

Ans: \$ \_\_\_\_\_

33. Arrange the following fractions in ascending order:

$$\frac{5}{6} \quad \frac{7}{12} \quad \frac{2}{3}$$

Ans: \_\_\_\_\_

34. Gina bought a piece of pizza. She cut it into 10 equal parts.  
She gave 2 pieces to her brother and 3 pieces to her sister.  
She ate 3 pieces herself.  
What fraction of the pizza was left? Give your answer in the simplest form.

Ans: \_\_\_\_\_



35. Look at the figure shown below, how many angles inside the figure are smaller than a right angle?

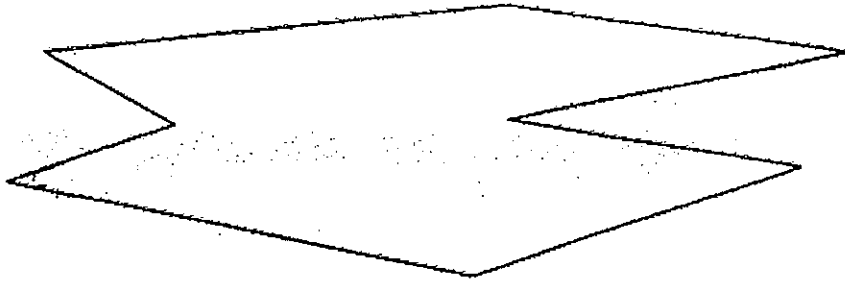

Ans: \_\_\_\_\_

36. What is the missing number in the box below?

4687, 4487, 3447, 3247, \_\_\_\_\_, 2007, 967

Ans: \_\_\_\_\_

37. The difference between 5921 and 6752 is the same as \_\_\_\_\_ + 163

Ans: \_\_\_\_\_

38. On Monday, Mrs Tan plucked 4 mangoes from the tree. For the next three days, the number of mangoes plucked each day was three times the number of mangoes plucked the day before.

How many mangoes did she pluck on Thursday?

Ans: \_\_\_\_\_

39. Tina bought a bag. She gave the cashier three \$50 notes, three \$10 notes, a \$5 note and two \$2 notes. She received \$3.35 change. What was the price of the bag?

Ans: \$ \_\_\_\_\_

40. Mrs Lee wanted to buy  $\frac{5}{6}$  of a cake to share among her children but the shop had only the portion shown below. What fraction of the cake was she short of?

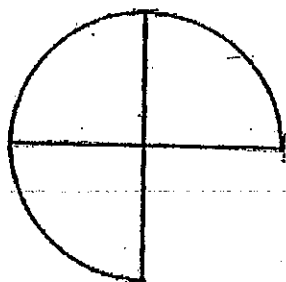

Ans: \_\_\_\_\_

**SECTION C (20 marks)**

For Questions 41 to 46, show your working clearly in the space provided below each question and write your answer with suitable units in the spaces provided. All diagrams are not drawn to scale. Answers in fractions must be expressed in the simplest form. Marks will be awarded for relevant working. The number of marks available is shown in brackets [ ] at the end of each question or part-question.

---

41. There are 20 flags on a string. They are equal distance apart. The distance between the first flag and the eighth flag is 140 cm.  
What is the distance between the first flag and the 20<sup>th</sup> flag?

Ans: \_\_\_\_\_ [3]

42. The figure below is made up of 2 identical squares.  
a) Find the area of the figure.  
b) Find the perimeter of the figure

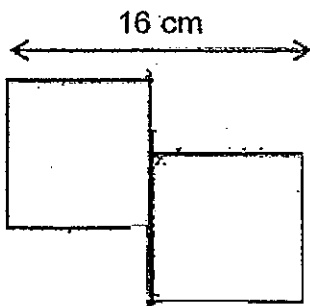

Ans: a) \_\_\_\_\_ [2]

b) \_\_\_\_\_ [1]

43. The chairs in a hall are to be arranged in rows. If 6 chairs are put in a row, there will be 4 chairs left over. If 7 chairs are put in a row, there will be 3 chairs short. How many chairs are there in the hall?

Ans: \_\_\_\_\_ [3]

44. Mr Sim bought 30 shirts and blouses. There were 8 buttons on each shirt and 3 buttons on each blouse. There were 175 buttons altogether. How many blouses did he buy?

Ans: \_\_\_\_\_ [3]

45. Mrs Lee bought 5 trays of eggs. Each tray contained 40 eggs. She broke  $\frac{3}{8}$  of the eggs. She used  $\frac{1}{5}$  of the remainder to make a cake. How many eggs did she use?

---

Ans: \_\_\_\_\_ [4]

46. There were 343 pieces of 10-cent, 20-cent and 50-cent coins in a piggy bank. There were 7 more 20-cent coins than 10-cent coins and thrice as many 50-cent coins as 20-cent coins.

(a) How many 10-cent coins were there?

(b) How much did the 50-cent coins add up to?

Ans: (a) \_\_\_\_\_ [2]

(b) \_\_\_\_\_ [2]

**-End of Paper-**

**Please check your work carefully ☺**

# ANSWER SHEET

**EXAM PAPER 2013**

**SCHOOL : RAFFLES GIRLS'**

**SUBJECT : PRIMARY 3 MATHEMATICS**

**TERM : SA2**

Q1	Q2	Q3	Q4	Q5	Q6	Q7	Q8	Q9	Q10	Q11	Q12	Q13	Q14	Q15	Q16	Q17
1	4	3	4	4	3	2	4	1	2	2	2	2	2	3	4	1

Q18	Q19	Q20
2	4	4

Q21) hundreds

Q22) A= 2

B= 1

Q23) 1548

Q24) Oranges

Q25) 200

Q26)

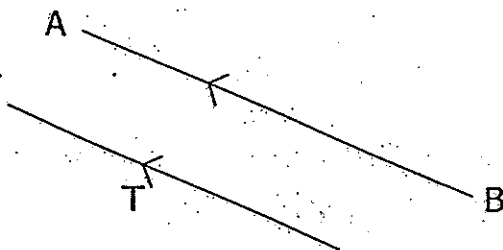

Q27) 84cm<sup>2</sup>

Q28) Nine thousand, eight hundred and forty

Q29) 5km. 80m

Q30) 2850ml

- Q31) 7kg 750g  
 Q32) \$6211  
 Q33)  $7/12, 2/3, 5/6$   
 Q34)  $1/5$   
 Q35) 4  
 Q36) 2207  
 Q37) 668  
 Q38) 108 mangoes  
 Q39) \$185.65  
 Q40)  $1/12$

- Q41)  
 $8-1=7$   
 $140\text{cm} \div 7 = 20\text{cm}$   
 $20-1=19$   
 $20\text{cm} \times 19 = 380\text{cm}$

The distance between the first flag and the 20<sup>th</sup> flag is 380cm.

- Q42)  
 a)  $16\text{cm} \div 2 = 8\text{cm}$   
 $16\text{cm} \times 8\text{cm} = 128\text{cm}^2$   
 The area of the figure is  $128\text{cm}^2$ .

- b)  $16\text{cm} \times 2 = 32\text{cm}$   
 $12\text{cm} \times 2 = 24\text{cm}$   
 $32\text{cm} + 24\text{cm} = 56\text{cm}$   
 The perimeter of the figure is 56cm.

- Q43)  
 There are 46 chairs in the hall.

Q44)

Number of buttons and shirts	Number of buttons and blouses	Total buttons	Total blouses and shirts	✓ / X
$20 \times 8 = 160$	$10 \times 3 = 30$	$160 + 30 = 190$	$20 + 10 = 30$	X
$21 \times 9 = 168$	$9 \times 3 = 27$	$168 + 27 = 195$	$21 + 9 = 30$	X
$19 \times 8 = 152$	$11 \times 3 = 33$	$152 + 33 = 185$	$19 + 11 = 30$	X
$17 \times 8 = 136$	$13 \times 3 = 39$	$136 + 39 = 175$	$17 + 13 = 30$	✓

He bought 13 blouses.



Q45)

$$40 \times 5 = 200$$

$$1 \text{ unit} \rightarrow 200 \div 8 = 25$$

$$5 \text{ units} \rightarrow 25 \times 5 = 125$$

$$\text{Eggs she used} \rightarrow 125 \div 5 = 25$$

Mrs Lee used 25 eggs.

Q46)

$$\text{a) } 343 + 7 = 350$$

$$1 \text{ unit} \rightarrow 350 \div 5 = 70$$

$$10 \text{ cents} \rightarrow 70 - 7 = 63$$

There were 63 10-cent coins.

$$\text{b) Number of 50-cent coins} \rightarrow 70 \times 3 = 210$$

$$\text{Total value of 50-cent coins} \rightarrow 210 \times \$0.50 = \$105$$

The total value of 50-cent coins is \$105.

