



RAFFLES GIRLS' PRIMARY SCHOOL
SEMESTRAL ASSESSMENT 2

Name : _____ Index No: _____ Class: P3

22 October 2012 **SCIENCE** **Attn: 1 h 15 min**

SECTION A (24 x 2 marks)

For each question from 1 to 24, four options are given.

One of them is the correct answer. Make your choice (1, 2, 3 or 4).

Shade the correct oval (1, 2, 3 or 4) on the Optical Answer Sheet (OAS) provided.

Section A	48	
Section B	32	
Your score out of 80 marks		
	Class	Level
Highest score		
Average score		
Parent's signature		

1. Which one of the following is a living thing?

- (1) Fire
- (2) Cloud
- (3) Mushroom
- (4) Horseshoe magnet

2. The picture below shows a man perspiring after spending 1 hour under the hot sun.

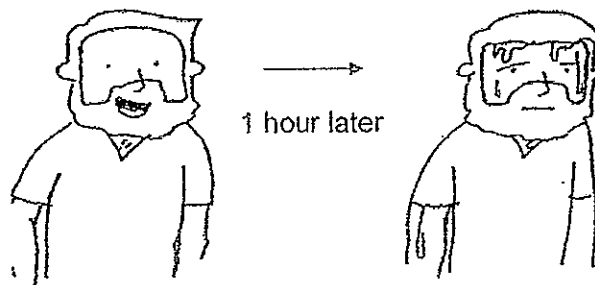

We can conclude that living things _____.

- (1) can die
- (2) can grow
- (3) need air, food and water
- (4) respond to changes in their environment

3. The graph below shows the mass of Sally over a period of 4 years.

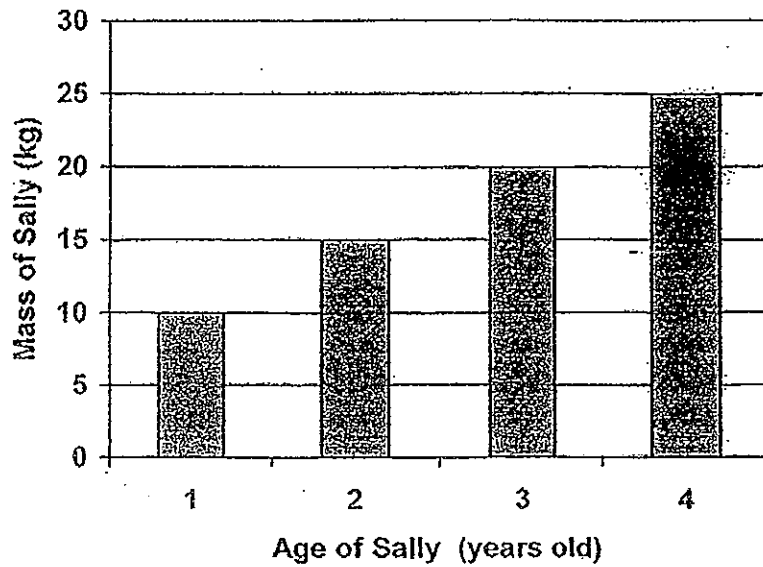

Based on the graph above, which of the following statements is most likely to be true?

- (1) Sally's mass increased as she grew.
- (2) Sally had a mass of 25 kg when she was 3 years old.
- (3) Sally had a lesser mass at 3 years old than at 2 years old.
- (4) Sally's mass remained constant between 1 and 3 years old.

4. Study the classification ~~tab~~^{table} below.

A	B
Eagle Spiny anteater	Man Dolphin

The animals are grouped according to _____.

- (1) how they take in air
 - (2) how they reproduce
 - (3) their body movement
 - (4) their outer body covering
5. Study the animals A, B, C and D, as shown below.



Animal A

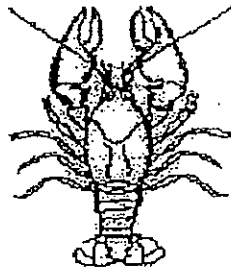

Animal B

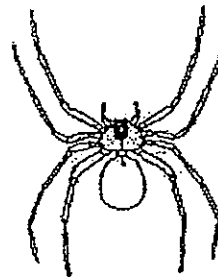

Animal C

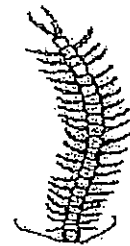

Animal D

Which animal is an insect?

- (1) Animal A
- (2) Animal B
- (3) Animal C
- (4) Animal D

6. Study the flow chart of three animals, X, Y and Z, below.

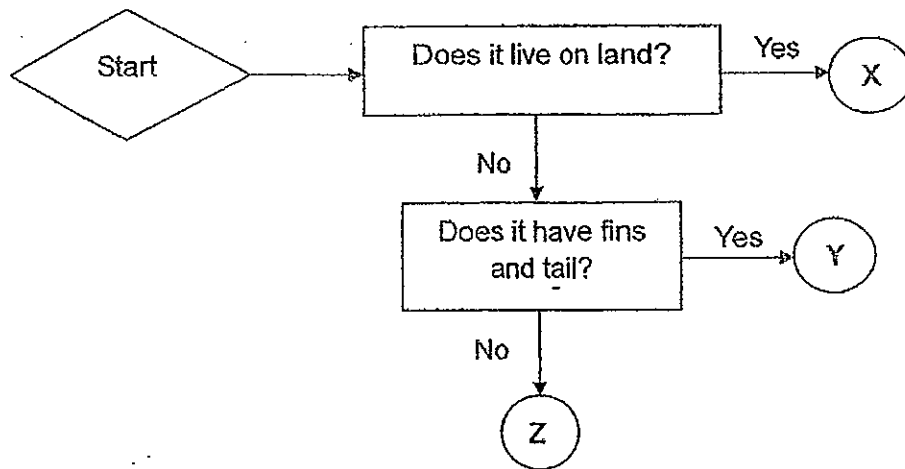

Which of the following best represents X,Y and Z respectively?

	X	Y	Z
(1)	Giraffe	Eel	Squid
(2)	Bear	Shark	Octopus
(3)	Tiger	Platypus	Goldfish
(4)	Dolphin	Zebra	Platypus

7. The flow chart below shows the characteristics of plants A, B, C and D.

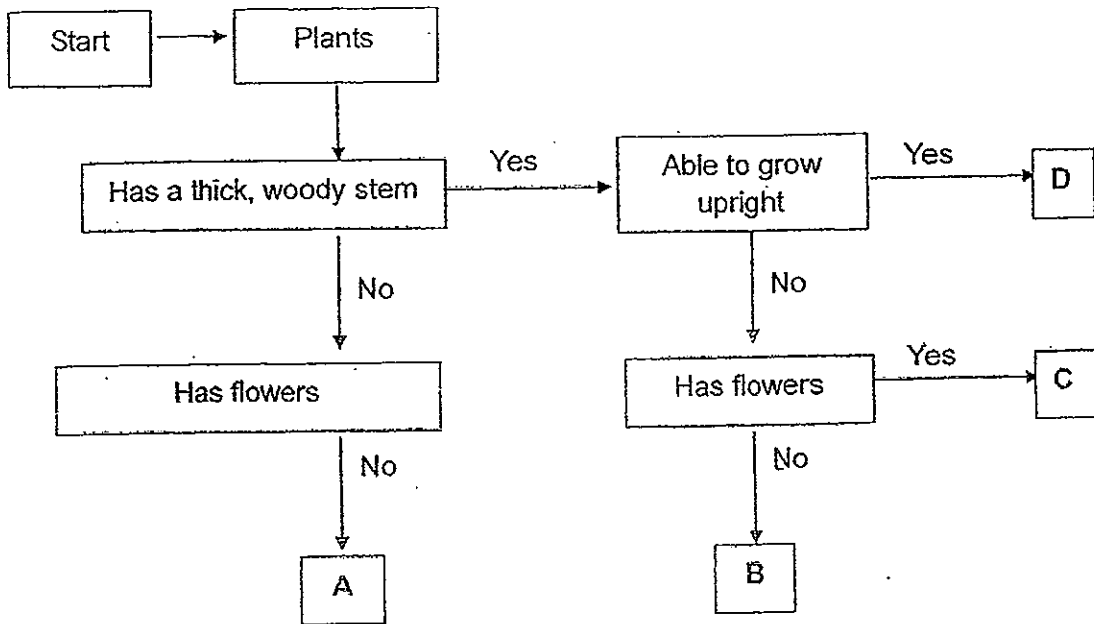

Study the plant below carefully.

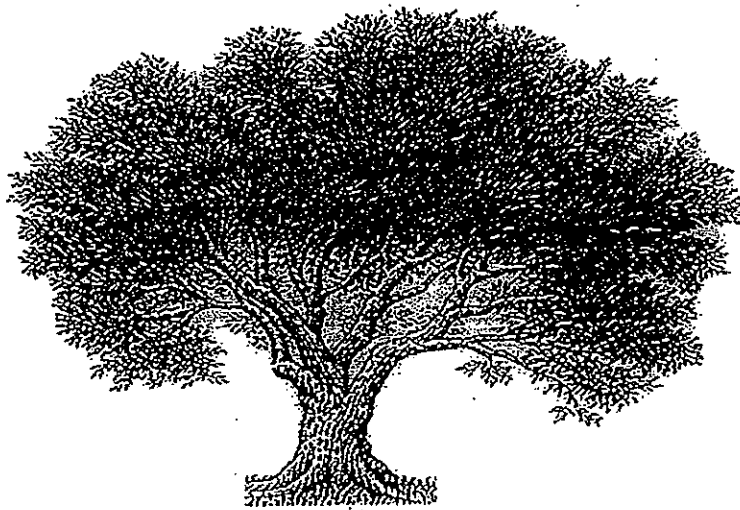

Based on your observation and information on the flow chart, which of the following plants, A, B, C or D, best represents the plant shown in the diagram above?

- (1) A
- (2) B
- (3) C
- (4) D

8. Study the pictures shown below.



Grape vine



Rose plant



Banana tree



Fern

Which one of the above plants does not belong to the same group as the rest?

- | | |
|-----------------|----------------|
| (1) Grape vine | (2) Rose plant |
| (3) Banana tree | (4) Fern |

9. Which of the following is not one of the uses of good bacteria?

- (1) Bacteria help in the digestion of food.
- (2) Bacteria can be used to get rid of dust.
- (3) Bacteria can be used to make medicines.
- (4) Bacteria can be used to make food such as yogurt.

10. Which of the following best represents a particular stage in a life cycle?

- (1) A seed sprouting.
- (2) A fish breathing in water.
- (3) A cockroach nymph crawling.
- (4) A plant growing towards the light.

11. Study the table below.

	Looks after its young	Has 3-stage life cycle
Animal A	✓	✓
Animal B		✓

Based on the information above, which of the following most likely represents animal A and B respectively?

	Animal A	Animal B
(1)	Mealworm beetle	bee
(2)	Goldfish	Mealworm beetle
(3)	Duck	dragonfly
(4)	Chicken	housefly

12. Which one of the following shows the life cycle of a flowering plant correctly?

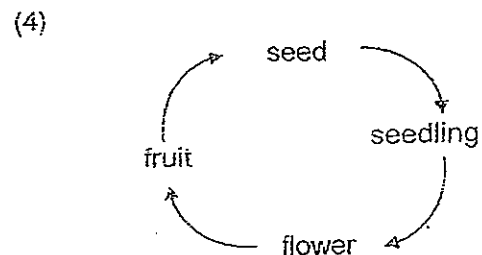
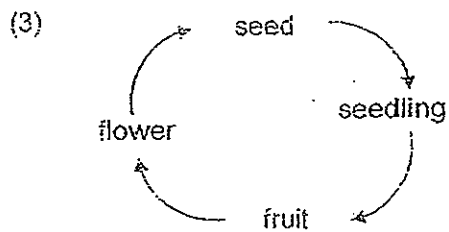
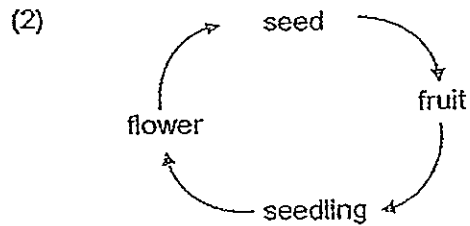
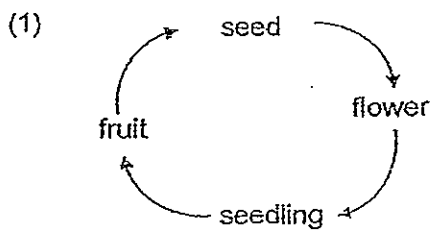

13. Study the life cycles of animal X and Y below.

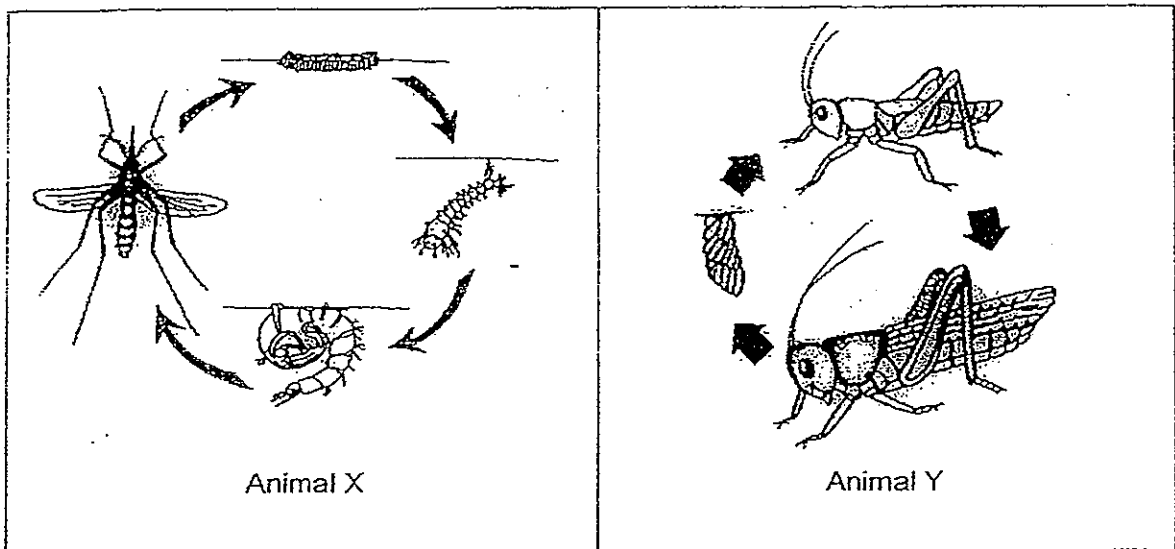

Which of the following statements about animals X and Y is/are true?

- A Both their young live in water.
- B Both animals do not have wings at adult stage.
- C Both adults do not give birth to their young alive.
- D Both animals are pests in at least one stage of their cycles.

- (1) D only
- (2) A and B only
- (3) B and C only
- (4) C and D only

14. Study the diagrams below carefully.

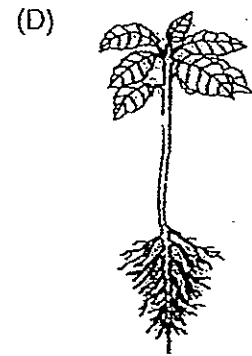
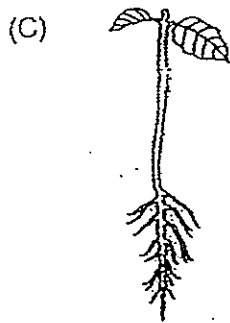
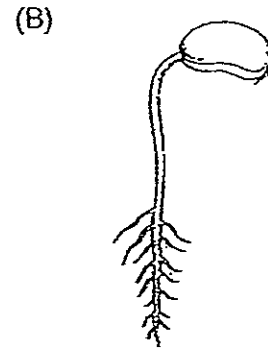
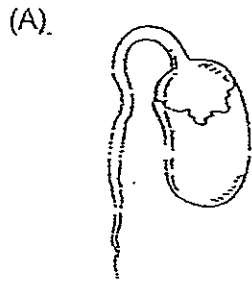

Which of the seedlings above can make their own food?

- (1) A and B only
- (2) C and D only
- (3) B, C and D only
- (4) A, B, C and D

16. Sally set up 4 set ups as shown below. She placed the set ups , A, B and C, in her room and left jar D in the refrigerator.

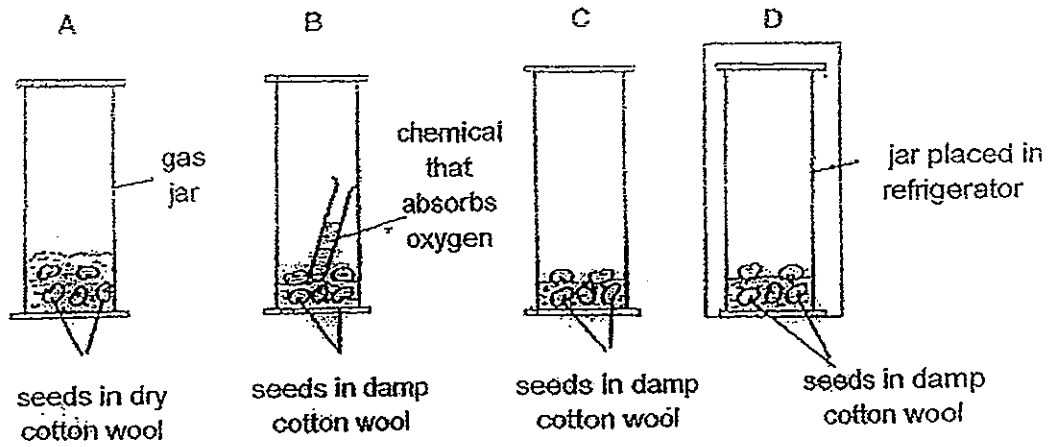

In which of the following set-ups will the seeds germinate after a few days?

- (1) A
- (2) B
- (3) C
- (4) D

16. Study the classification chart below.

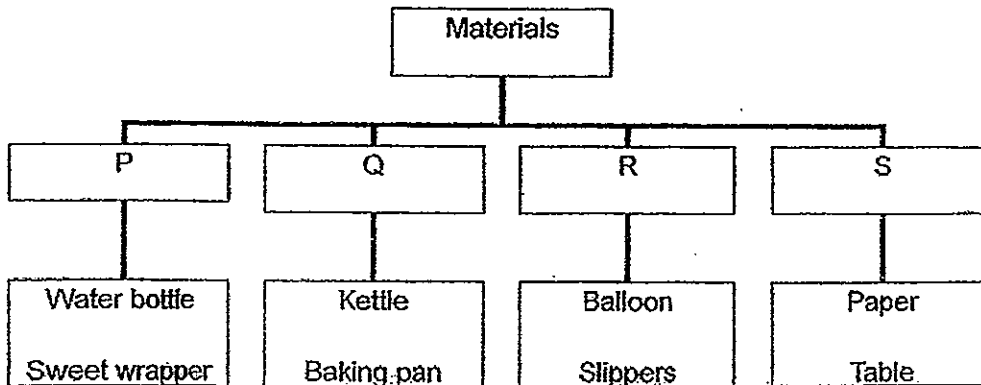

Which of the following best represents P, Q, R and S respectively?

	P	Q	R	S
(1)	Plastics	Wood	Rubber	Metal
(2)	Glass	Plastics	Wood	Rubber
(3)	Plastics	Metal	Rubber	Wood
(4)	Glass	Rubber	Plastics	Metal

17. The dress and handkerchief shown below are made of cotton.

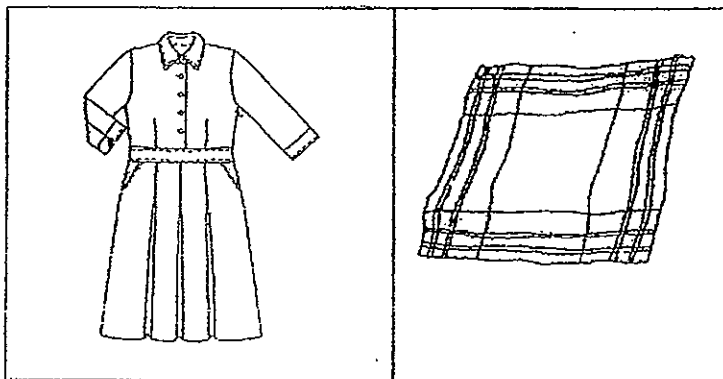

Why is cotton suitable for making the dress and the handkerchief?

- A Cotton is waterproof.
- B Cotton is a flexible material.
- C Cotton absorbs water easily.

- (1) A only
- (2) B and C only
- (3) B only
- (4) A, B and C

18. Mrs Zhou sliced some bread with a knife on a cutting board. After that, she observed that there were scratches on the cutting board.

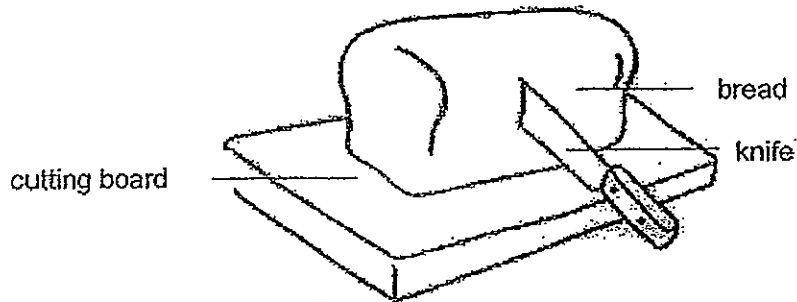

Which one of the following most likely explains Mrs Zhou's observation?

- (1) The cutting board is harder than the knife.
- (2) The cutting board is stronger than the knife.
- (3) The knife is harder than the cutting board.
- (4) The knife is stronger than the cutting board.

19. A compass was placed near a bar magnet.

Which of the following diagram shows the correct positioning of the compass needle?

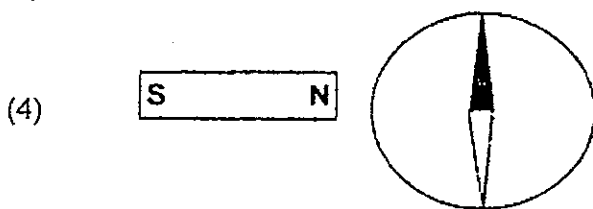
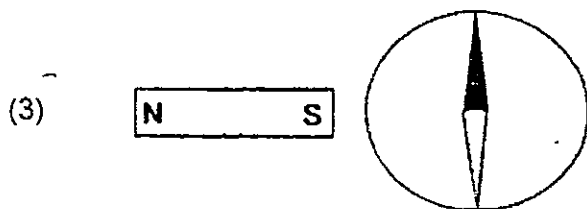
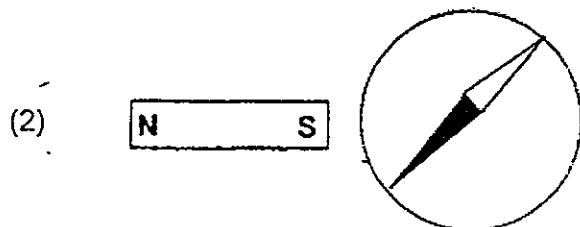
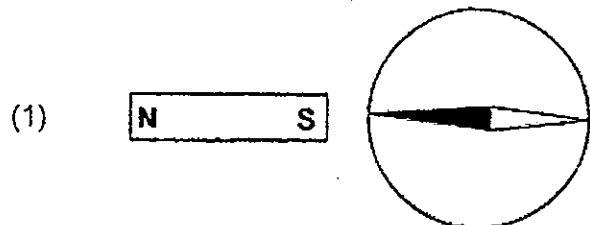

20. Jane conducted an experiment with a bar magnet as shown below.

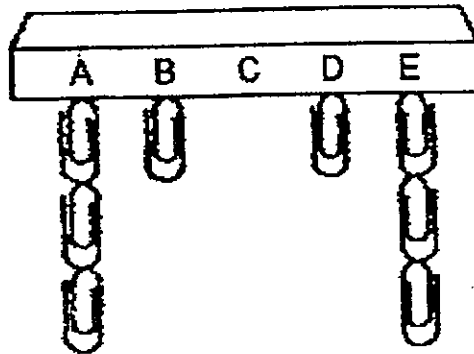

What conclusion can Jane make from her observation above?

- (1) Magnets are weakest at its poles.
 - (2) Magnets are strongest at its poles.
 - (3) The paper clips are made of non-magnetic materials.
 - (4) Only the poles of the magnets attract the paper clips.
21. Jane, Ann, Tim and William each made a statement about magnet as follow:

William : "There are two poles on a magnet."

Tim : "Magnetism can act at a distance"

Jane : "Magnets are made of magnetic materials.

Ann : "Magnets with like poles facing each other will attract."

Whose statement about the magnet is incorrect?

(1) Jane

(2) Ann

(3) Tim

(4) William

22. A magnet was made using the stroking method as shown below.

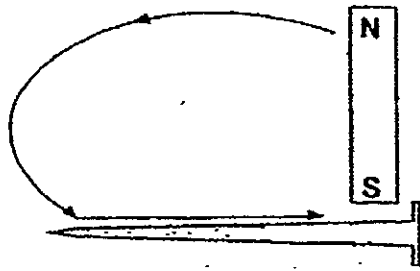

Which of the follow diagrams shows how the magnetized nail will interact with the magnet which is brought near it?

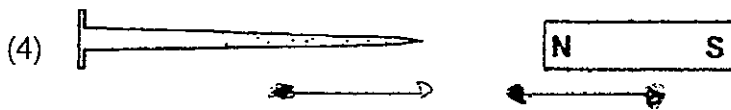
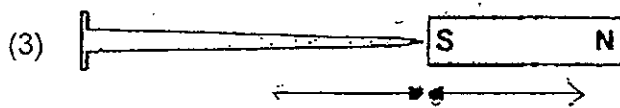
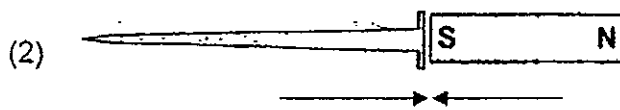
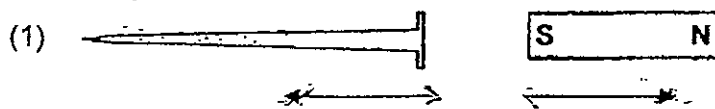

23. Which of the following set-ups will produce the strongest temporary magnet?

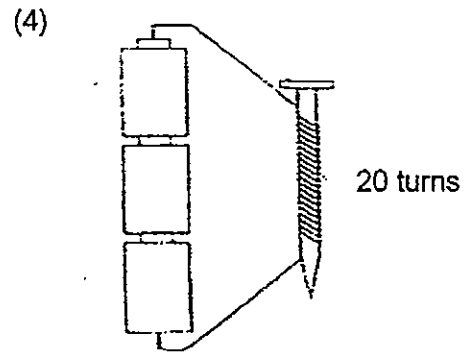
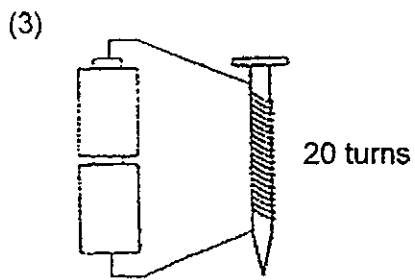
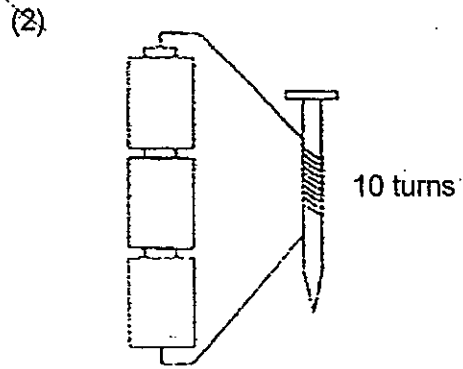
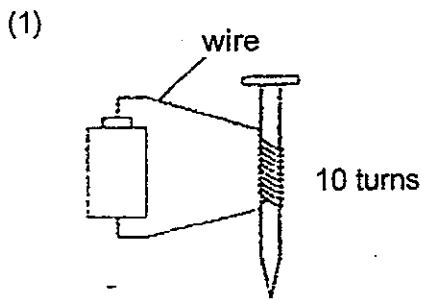

24. Three bar magnets with their poles marked A to F can be arranged as shown below.

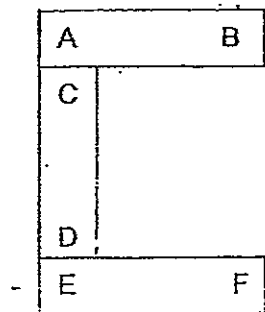

Which one of the following diagrams shows a possible arrangement of two of the above magnets?

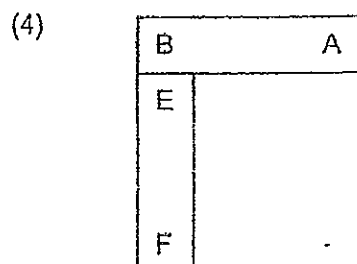
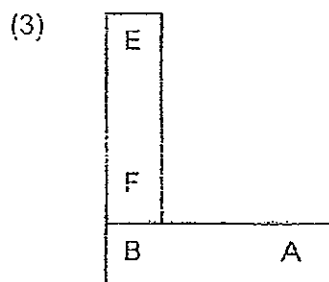
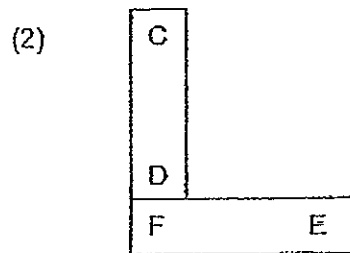
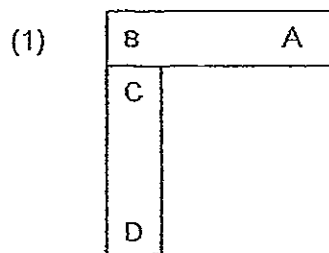

Marks

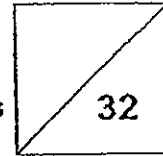

Name : _____ Index No: _____ Class: Primary 3 _____

SECTION B (32 marks)

For questions 25 to 39, write your answers clearly in the spaces provided.

The number of marks available is shown in the brackets [] at the end of each question or part question.

25. Peter placed four things into four separate tanks, A, B, C and D. He placed 100g of food and 100ml of water into each tank.

At the end of two days, he recorded the amount of food and water left in each tank.

Tank	Amount of food left (g)	Amount of water left (ml)
A	70	20
B	20	30
C	100	100
D	0	0

Which tank most likely contained a non-living thing? Explain your answer clearly. [1]

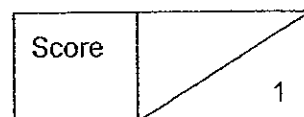

26. Sarah grew and observed a bean plant for 4 weeks. She record its height and mass in the table below.

Week	1	2	3	4
Height (cm)	2	5	?	11
Mass (g)	3	7	10	16

(a) Sarah forgot to measure the bean plant's height at the third week. [1]
What could be the possible height of the plant at the third week?

(b) What characteristic of living thing can Sarah conclude based on her [1]
observation above?

27. The classification chart below shows how some animals are grouped.

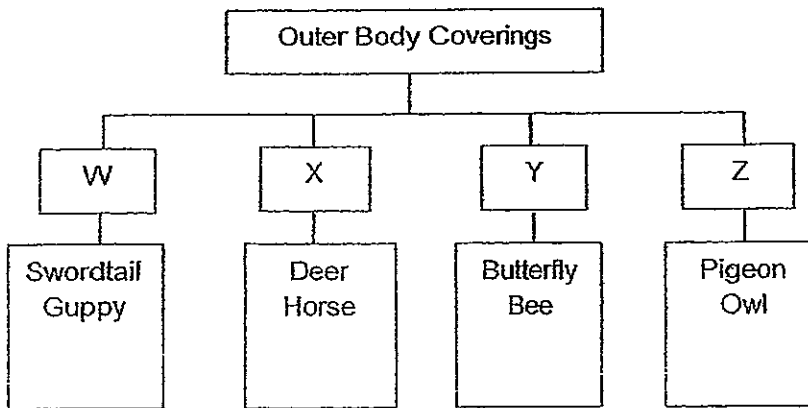

(a) Name the body coverings of animals in group W and Z respectively. [1]

W: _____

Z: _____

(b) Which group, W, X, Y or Z, does a bat belong to? [1]

Score	4
-------	---

28. A scientist discovered an animal Y in a jungle. He made two observations of the animal as listed below.

- | |
|--|
| <ul style="list-style-type: none">• Has hair on its body• Feeds its young with milk |
|--|

- (a) Which group of animal does animal Y belong to? [1]

- (b) Write down another unique characteristic of animal Y. [1]

29. The diagram below shows three living things.



Bamboo



Aloe Vera

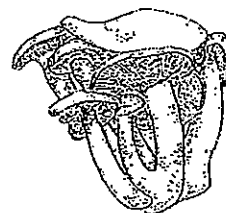

Toadstools

- (a) Which of the above living things can make food? [1]

- (b) Name the group of living things that the toadstools belong to. [1]

Score	<hr/>
	4

30. Study the diagram below carefully.



-pine tree



water lily



rambutan tree

Write down the names of the above organisms in the correct box below.

[3]

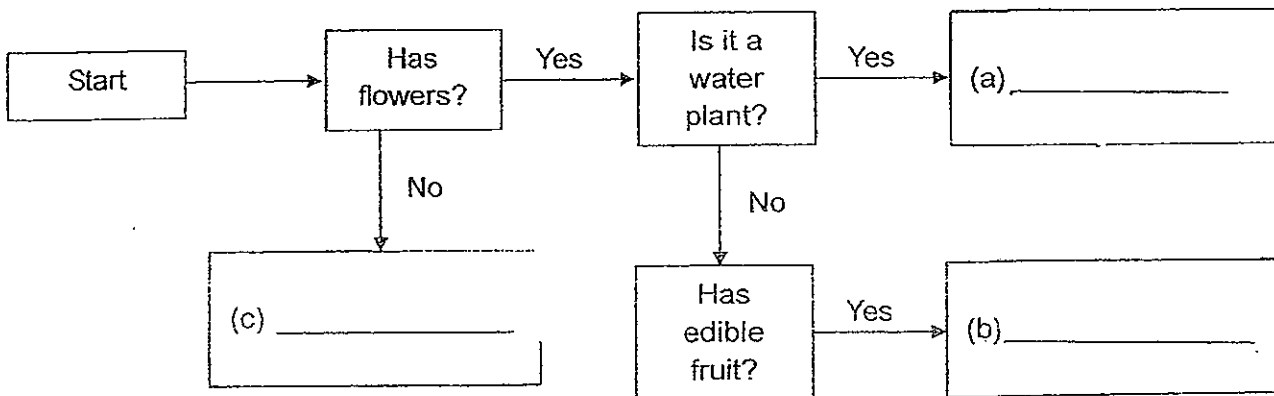

Score	3
-------	---

31. The pictures below show the different development stages in the life cycle of a frog.

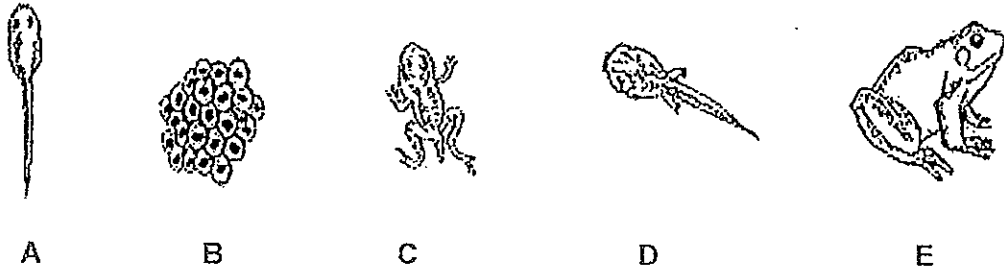

(a) Arrange the above pictures in the correct order of development of the frog. [1]
Write the letters represent each stage in the boxes provided below.

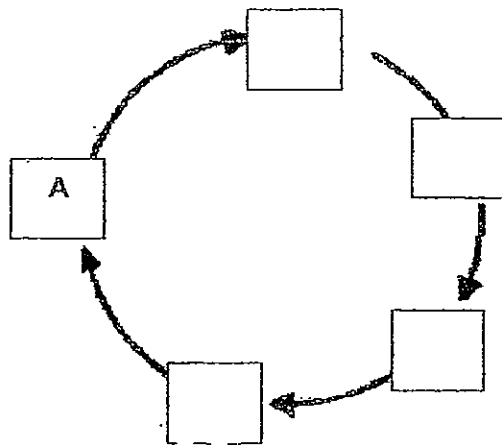

(b) Based on the life cycle above, state one difference between the animal at [1]
stage A and E.

Score	2
-------	---

32. Study the life cycles of the butterfly and cockroach shown below.

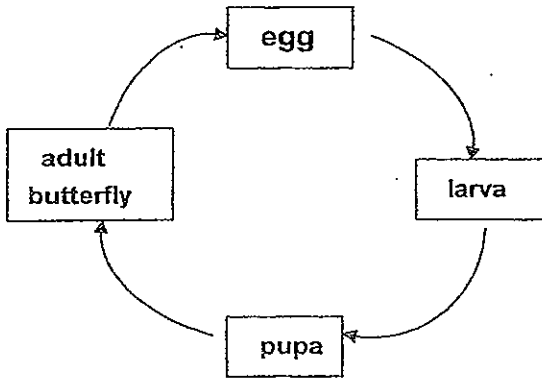

Life cycle of a butterfly

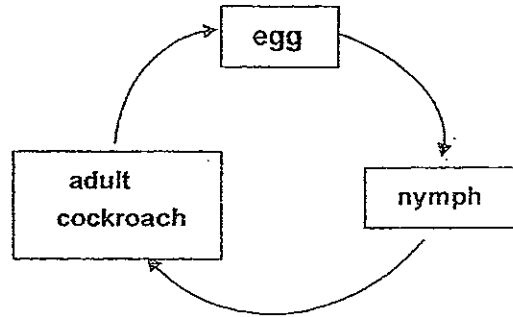

Life cycle of a cockroach

Answer the following questions based on the life cycles above.

(a) State one similarity between the life cycle of the butterfly and cockroach. [1]

(b) State one difference between the life cycle of the butterfly and cockroach. [1]

Score	2
-------	---

33. The diagram below shows a germinating seed.

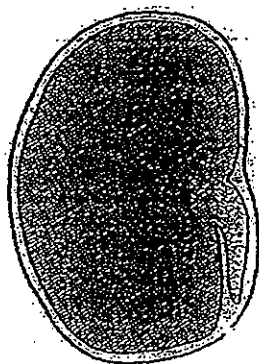

(a) Name and label the part that provides food for the germinating seed [1]
in the diagram above.

(b) What is the function of the seed coat? [1]

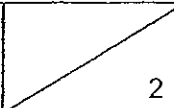
Score	
-------	---

34.

Alisha aimed to observe a seed grow into a seedling. She placed the seed in a room and recorded the mass of the seed leaf and the shoot during the growth over 6 days. She recorded the results as shown in the table below.

	Day 1	Day 2	Day 3	Day 4	Day 5	Day 6
P	1 g	0.9 g	0.7 g	0.4 g	0.2 g	0.1 g
Q	0g	0.2 g	0.4 g	0.7 g	0.8 g	1 g

- (a) Which measurement, P or Q, most likely represents the mass of the seed leaf? Explain your answer clearly. [2]

35

Complete the classification chart using ALL the materials given in the box below. [2]

Wool	Clay	Cotton	Plastics
------	------	--------	----------

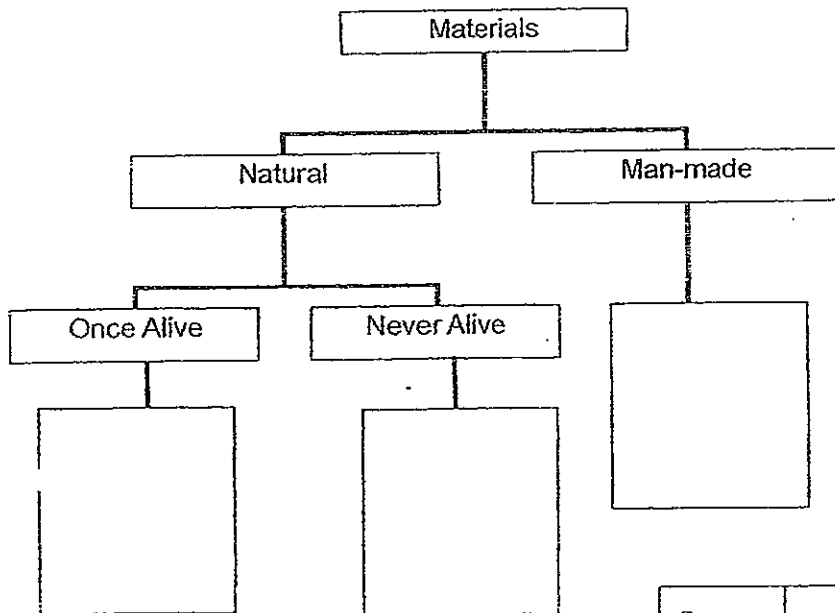

25

Score	4
-------	---

36. Study the table below.

Material	Flexible	Hard	Strong
R	✓	✓	
S	✓		
T		✓	✓

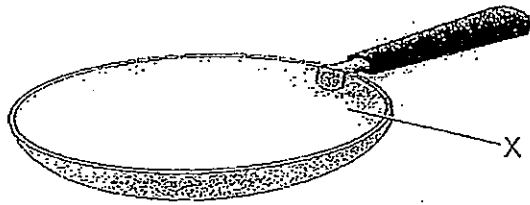

- (a) Which material, R, S or T, is most suitable to make part X of the frying pan? Give a reason for your answer. [1]

- (b) Based on the information in the table above, which two materials are hard? Describe an appropriate test to determine which material is harder. [2]

Score	3
-------	---

37. John created an electromagnet as shown in the diagram below. He wanted to find out the relationship between the number of coils of wire round the iron rod and the number of jump rings attracted by it.

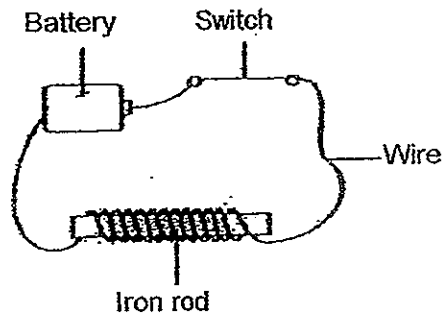

After each test, John increased the number of coils of wire around the iron rod. He then tested his electromagnet and recorded his observations as shown in the table below.

Number of coils	Number of jump rings attracted
5	2
10	5
20	9
30	14

- (a) Based on the results above, what is the relationship between the number of coils round the iron rod and the number of jump rings the magnetized iron rod attracted? [1]

- (b) In order for John to carry out a fair test, which of the following variables should he keep the same? Place a tick (✓) beside the variables that should be kept the same. [1]

Variables	Tick if needed
Type of wire	
Number of coils	
Number of batteries	
Length of iron rod	

Score	2
-------	---

38. Raju prepared an experiment set-up as shown in the diagram below. Two magnets, A and B, with like poles facing each other were suspended from a bar. They were pulled away from the same distance from sheet X.

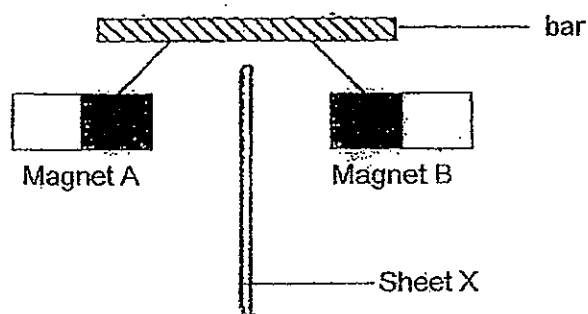

When Raju let go of the two magnets, he observed the results as shown below.

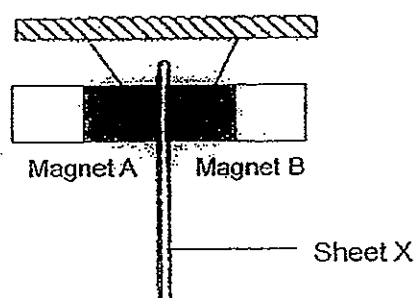

- (a) What material was sheet X most likely be made of? [1]

- (b) Explain your answer in (a) [1]

- (c) What would Raju observe if the sheet X in the above set-up was replaced with a plastic sheet? [1]

Score	3
-------	---

39. Sofea bought new cleaning sponges to clean the outer surface of the window from inside the room as shown in the diagram below.

She has to hold the handle of the cleaning sponge which is on the inner surface of the window and slide it up and down in order to use the cleaning sponges. The two cleaning sponges will move together.

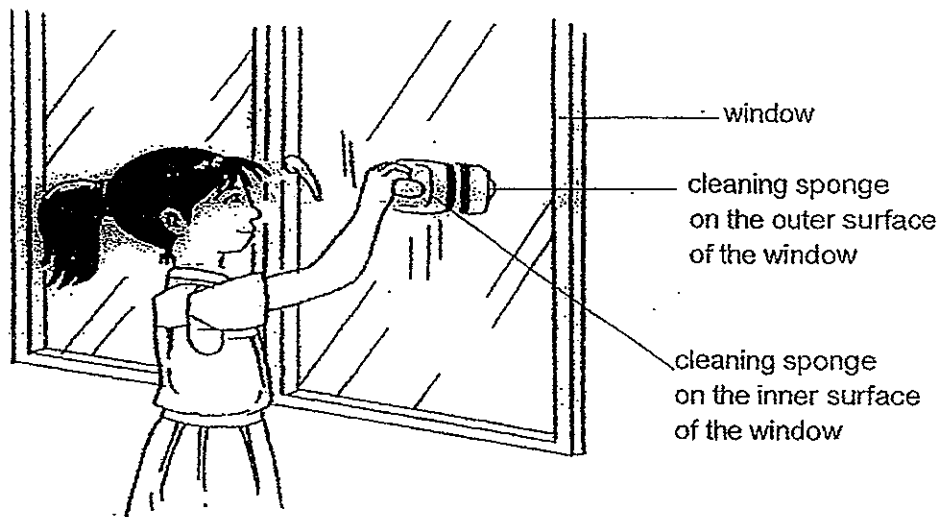

Explain clearly why the two cleaning sponges were able to move at the same time helping Sofea clean the outer surface of the window. [2]

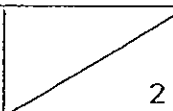
score	
-------	---

END OF PAPRR

Setters Ms Luo Zhiqing, Mdm Shaheena Kandoth



ANSWER SHEET

EXAM PAPER 2012

SCHOOL : RAFFLES GIRLS'
SUBJECT : PRIMARY 3 SCIENCE

TERM : SA2

Q1	Q2	Q3	Q4	Q5	Q6	Q7	Q8	Q9	Q10	Q11	Q12	Q13	Q14	Q15	Q16	Q17
3	4	1	2	1	2	4	4	2	1	3	4	4	2	3	3	2

Q18	Q19	Q20	Q21	Q22	Q23	Q24
3	1	2	2	2	4	3

25) Tank C: It did not take in any food and water like all living things.

26) a) 8cm.

b) Living things grow.

27) a) W: Scales Z: Feathers

b) Group X.

28) a) Mammals.

b) Animal Y gives birth to young alive.

29) a) Bamboo and aloe Vera.

b) Fungi.

30) a) Water Lily b) Rambutan tree c) Pine tree

31) a)

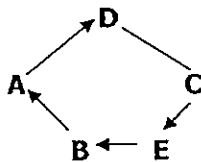

31)b)Stage E has legs but stage A does not have legs.

32)a)They go through an egg stage.

b)A butterfly has 4 stages in its life cycle but a cockroach has 3 stages in its life cycle.

33)a)

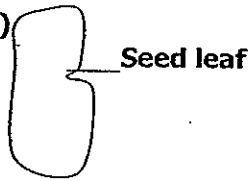

b)It protects the baby plant.

34)a)The mass of the seed leaf will decrease overtime as the germinating seed has been using the food provided in the seed leaf.

35)Wool Clay Plastic
Cotton

36)a)Material T. It is hard and strong.

b)Scratch material R and T with each other. The harder material will not have any scratch mark.

37)a)The more the number of coils around the iron rod, the more the magnetised iron rod can attract the jump rings.

b)Type of wire
Number of batteries
Length of iron rod

38)a)Iron.

b)Material X should be made of a magnetic material because magnetic force cannot pass through a magnetic material.

c)Magnet A and B would repel each other.

39)Both the cleaning sponges contained magnets. The unlike poles of the magnet in the sponges are facing each other (thus)attracted to each other through the glass as the magnetisms can pass through the non-magnetic glass.

SUBJECT : PRIMARY 3 - SCIENCE
TERM : SA 2

43. i) Difference: The life cycle of a mosquito has 4 stages while the life cycle of the hen has three stages.

ii) Similarity: Both lay eggs

44. a) 4 staged life cycle

b) 3 staged life cycle

c) Insects

d) Amphibians

