



Anglo-Chinese School (Primary)

END-OF-YEAR EXAMINATION 2012
SCIENCE
PRIMARY FOUR
BOOKLET A

Name: _____ ()

Class: Primary 4 _____

Date: 1 November 2012

Duration of paper: 1 h 45 min

Parent's/Guardian's signature

INSTRUCTIONS TO CANDIDATES

1. This question paper consists of 19 printed pages including this cover page.
2. Do not turn this page until you are told to do so.
3. Follow all instructions carefully.
4. Answer all questions.
5. Shade your answer on the Optical Answer Sheet (OAS) provided.



For each question from 1 to 30, four options are given. One of them is the correct answer. Make your choice and shade the correct oval (1, 2, 3 or 4) on the Optical Answer Sheet.

(60 marks)

1 Which one of the following is the function of a leaf on a plant?

- (1) Makes food.
- (2) Takes in water.
- (3) Takes in mineral salts.
- (4) Holds the plant upright.

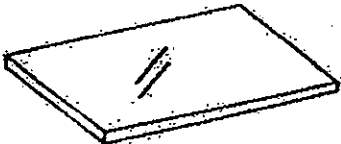
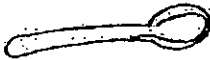
2 Which one of the following objects can be bent easily without breaking?

<p>(1) A sheet of glass</p> 	<p>(2) A plastic spoon</p> 
<p>(3) A cotton towel</p> 	<p>(4) A wooden ruler</p> 

3 Which one of the following shows the correct order when food moves through some parts of the digestive system?

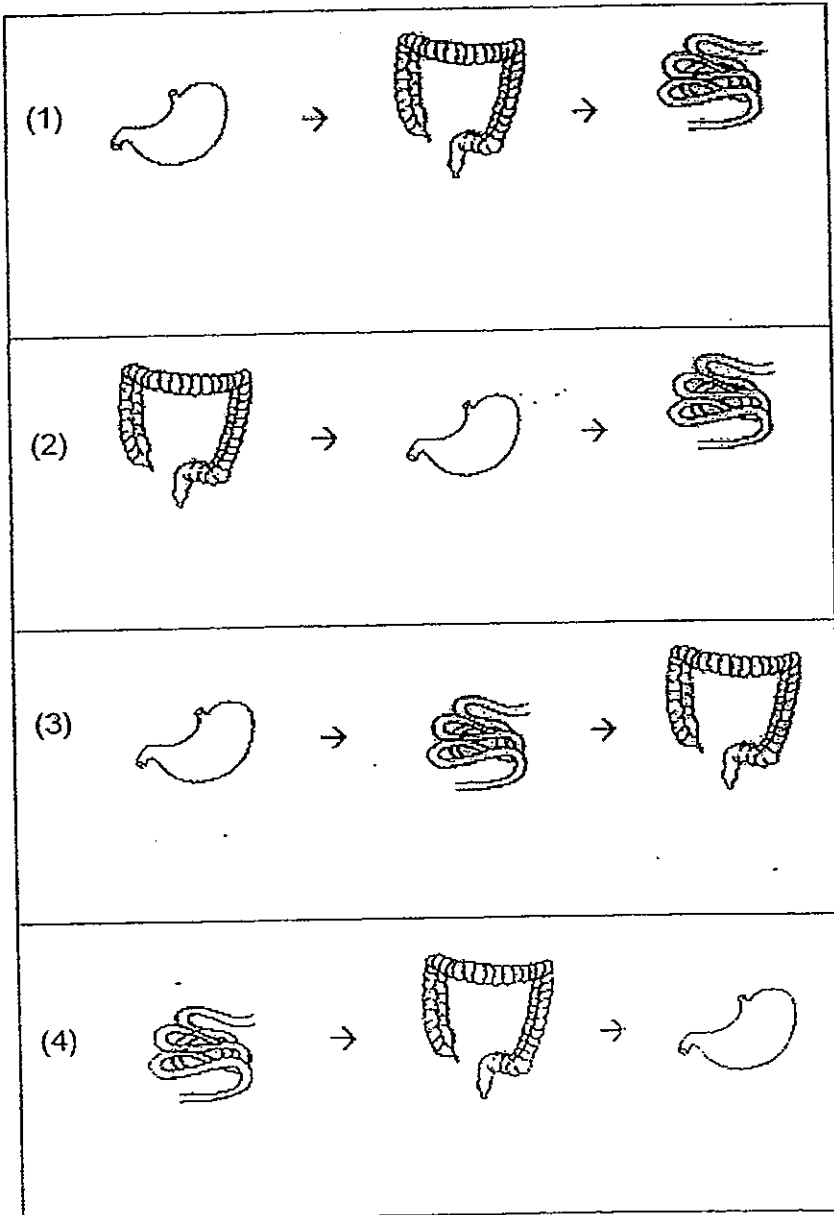

- 4 Simon brought a new badminton racket to school. His friends made the following comments about his racket.

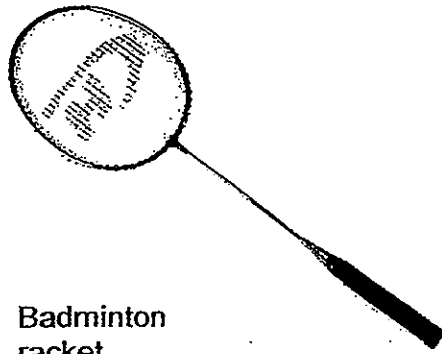

Badminton
racket

- A The badminton racket is a system because it has parts that work together to perform a function.
- B The badminton racket is a system because it is used for playing.
- C The badminton racket is not a system as it is a non-living thing.
- D The handle of the racket is not part of the system as the other parts are more important.

Which of the comment(s) is/are correct?

- (1) A only
- (2) A and B only
- (3) C and D only
- (4) B, C and D only

- 5 Study the flow chart below carefully.

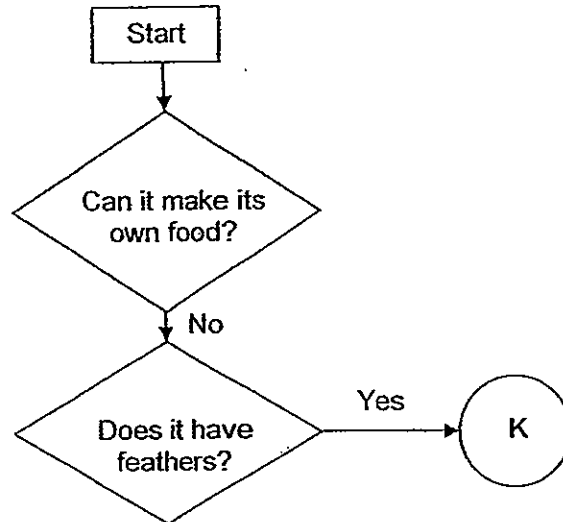

What could K be?

- (1) Bird
 - (2) Plant
 - (3) Insect
 - (4) Mammal
- 6 Which of the following parts below form part of the plant system?
- A pot
 - B soil
 - C roots
 - D flower
- (1) B and C only
 - (2) C and D only
 - (3) A, B and C only
 - (4) A, C and D only

7 Which one of the following properties is true for both air and a pencil?

- (1) They take up space.
- (2) They have definite shapes.
- (3) They have definite volumes.
- (4) They have no definite mass.

8 The diagram below shows the life cycle of an animal.

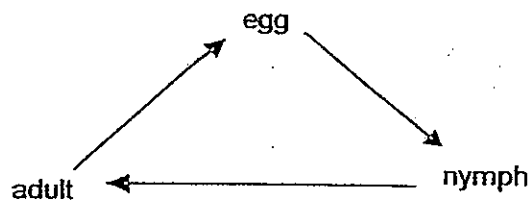

Which one of the following animals is likely to have the life cycle as shown above?

- (1) Frog
- (2) Chicken
- (3) Mealworm
- (4) Cockroach

9 Carol wanted to measure the mass of 150 ml of milk. Which of the following items should she use?

- A Beaker
- B String
- C Fixed weights
- D Lever Balance
- E Measuring Cylinder

- (1) A, B and C only
- (2) A, C and D only
- (3) B, C and E only
- (4) B, D and E only

10 Haron classified some materials according to their magnetic characteristics.

Magnetic materials	Non-magnetic materials
Steel	Gold
Copper	Rubber
Nickel	Aluminium
Iron	Wood

Which one of the following materials did he classify incorrectly?

- (1) Gold
- (2) Steel
- (3) Copper
- (4) Rubber

11 Which one of the following statements is true for the pupa stage in any life cycle?

- (1) The pupa does not eat.
- (2) The pupa lives on water only.
- (3) The pupa moults several times.
- (4) The pupa usually stops growing completely.

12 The diagrams below show the life cycles of a cockroach and a mosquito.

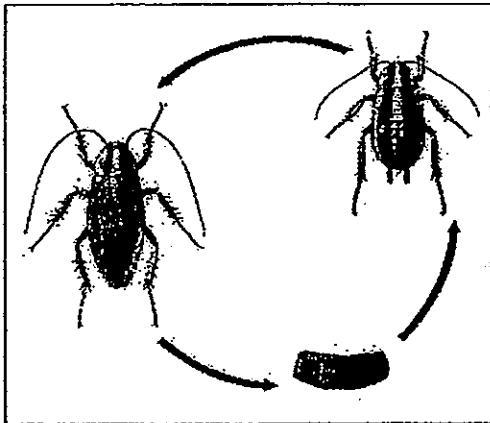

Based on the observation of the diagrams only, which of the following statements are correct?

- A Both animals lay their eggs on land.
- B The adults of the animals have wings.
- C The adults of the animals resemble their young.
- D There are 3 stages in a life cycle of a cockroach, but there are 4 stages in the life cycle of a mosquito.

- (1) A and C only
- (2) B and D only
- (3) A, B and C only
- (4) B, C and D only

- 13 A lump of plasticine was dropped from a height of ten metres. Which of the following will change when it hits the ground?

- A Mass of the plasticine
- B Shape of the plasticine
- C Volume of the plasticine
- D Surface area of the plasticine

- (1) A and B only
- (2) B and D only
- (3) A, B and C only
- (4) A, B and D only

- 14 Each of the containers below contains 40 cm^3 of water. Objects A, B and C are put into the container and the water level rose. What is the volume of object C?

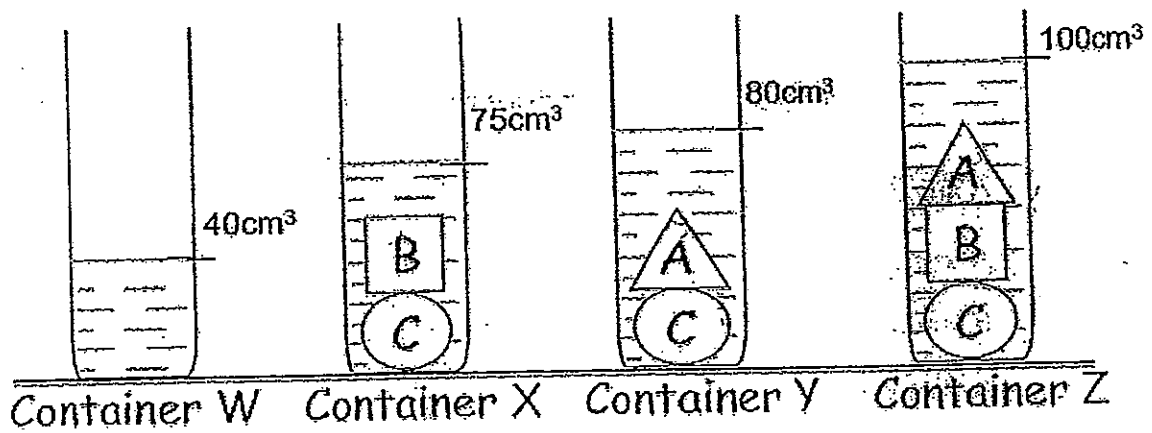

- (1) 10 cm^3
- (2) 15 cm^3
- (3) 20 cm^3
- (4) 25 cm^3

- 15 Study the two diagrams below. They show the life cycles of the carpenter ant under two different weather conditions. The number of days the ant spends at each stage is shown in the brackets.

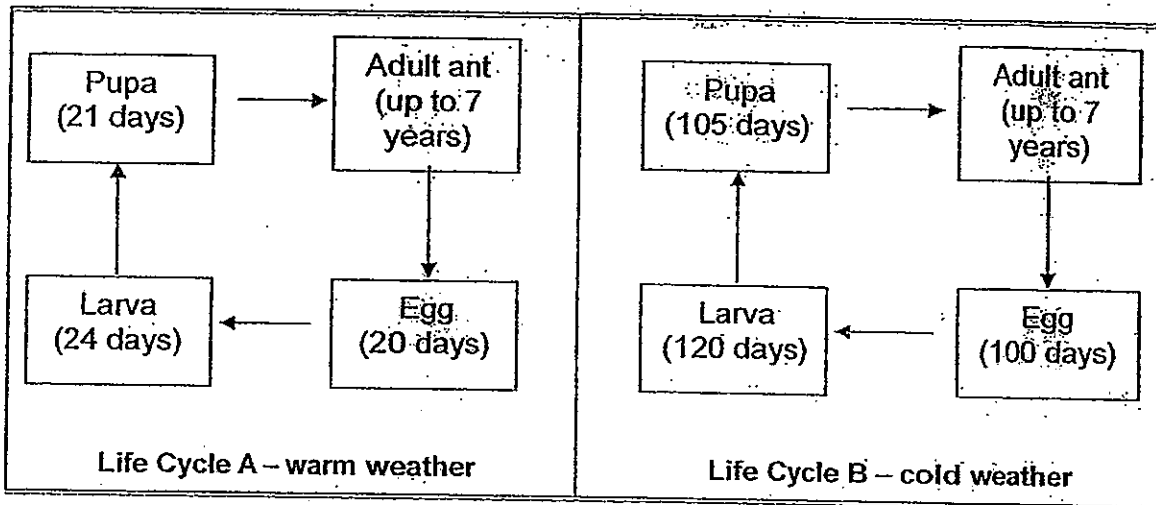

Based on the diagram above only, which of the following statements are true?

- A The life cycle is longer in colder weather.
 - B The adult carpenter ant lives longer in warm weather.
 - C The adult carpenter ant grows bigger in cold weather.
 - D The number of stages in both life cycles is the same.
- (1) A and B only
 (2) A and D only
 (3) B and C only
 (4) B and D only

- 16 Yvonne wrote down some statements about what she learnt about matter. Based on what she wrote, which one of the following groups of statements is definitely true about a solid and a liquid?

	Solid	Liquid
(1)	Cannot be compressed	Can be compressed
(2)	Floats on water	Does not float on water
(3)	Has a definite shape unless a force is applied	Takes the shape of the container
(4)	Does not have a definite shape	Has a definite shape

- 17 Tracy places a metal spoon in a cup of hot lemon tea.



The spoon becomes hotter after a while. Which one of the following explains this?

- (1) The cup loses heat to the hot lemon tea.
- (2) The spoon loses heat to the hot lemon tea.
- (3) The spoon gains heat from the hot lemon tea.
- (4) The hot lemon tea gains heat from the spoon.

- 18 The diagram shows a bar magnet hung such that it could turn freely. In which direction will it come to rest?

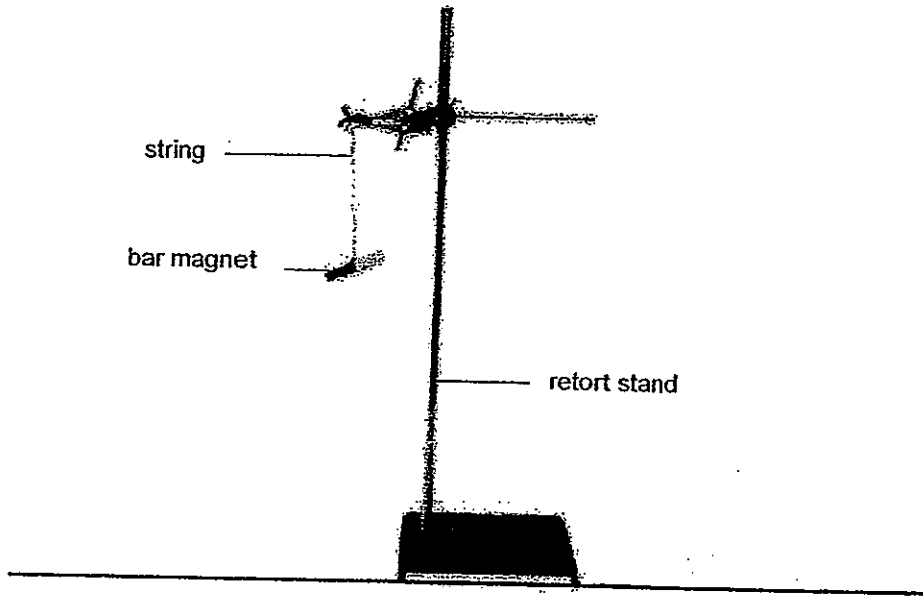

- (1) North-South
- (2) South-East
- (3) East-West
- (4) North-West

- 19 Clement placed a U-shaped magnet under an exercise book and an iron cube on the exercise book. When he moved the magnet under the exercise book to one side, the iron cube on the exercise book moved in the same direction as the magnet. However, when he repeated the experiment using the same iron cube and three similar exercise books, the iron cube did not move together with the magnet.

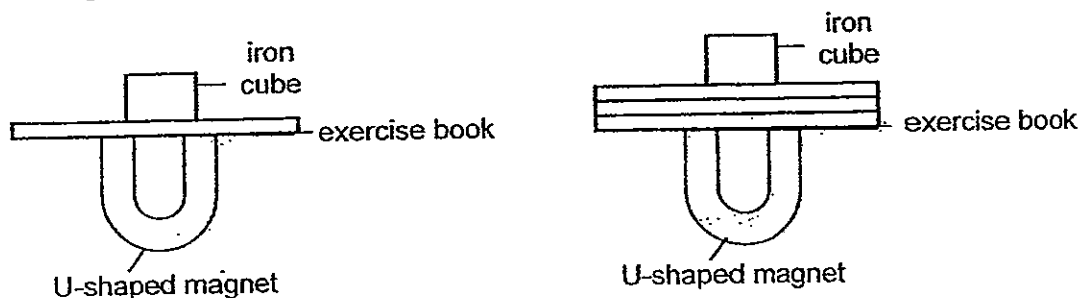

Which one of the following conclusions is true?

- (1) The iron cube is not made of a magnetic material.
 - (2) Magnetic attraction cannot pass through paper.
 - (3) The magnetic attraction by the iron cube is strong enough to pass through one exercise book.
 - (4) The magnetic attraction by the U-shaped magnet is not strong enough to pass through three exercise books.
- 20 Using the stroking method, which one of the following rods can be magnetized by a bar magnet?
- (1) Steel rod
 - (2) Plastic rod
 - (3) Rubber rod
 - (4) Wooden rod

- 21 Vanessa wanted to find out whether the number of coils of wire affects the magnetic strength of an electromagnet.

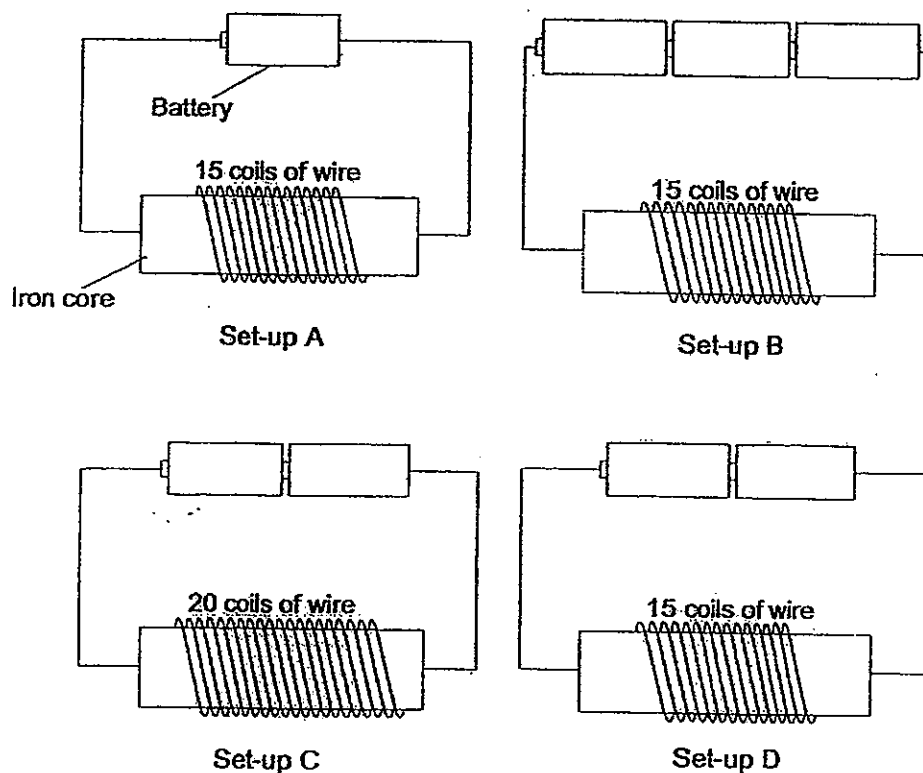

Which two of the above set-ups should Vanessa use so that she can conduct a fair test?

- (1) Set-up A and Set-up B
- (2) Set-up B and Set-up C
- (3) Set-up C and Set-up D
- (4) Set-up A and Set-up D

22 The diagram below shows five ring magnets looped through a wooden rod.

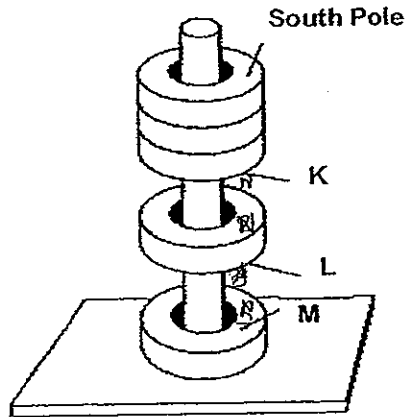

What are the poles labeled K, L and M?

	K	L	M
(1)	North	South	North
(2)	North	South	South
(3)	South	North	South
(4)	South	North	North

23 Raju boiled some water in the pot shown below.



He is able to hold the pot of boiling water using the plastic handles.
This is because plastic is a _____

- (1) good conductor of heat
- (2) poor conductor of heat
- (3) flexible material
- (4) light material

24 The diagram below shows the shadows of a vertical pole cast at different times on a sunny day. Arrange them in order of time beginning with the earliest. The timing when the shadow was casted under B has been given.

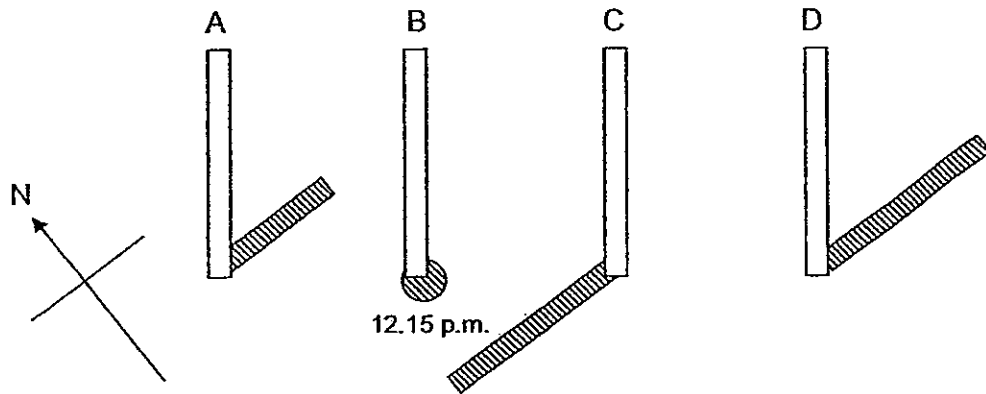

- (1) B, A, D, C
- (2) C, B, D, A
- (3) D, A, B, C
- (4) C, B, A, D

25 Study the diagram shown below carefully.

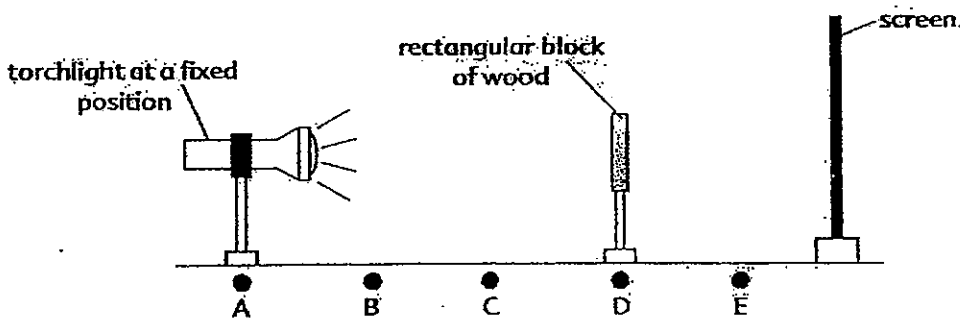

To obtain the smallest shadow, which of the following positions must be used?

	Position of light source	Position of rectangular block
(1)	A	D
(2)	A	E
(3)	B	D
(4)	B	E

- 26 A plastic ruler is attached to a copper wire as shown in the diagram below. A candle is lighted under the copper wire.

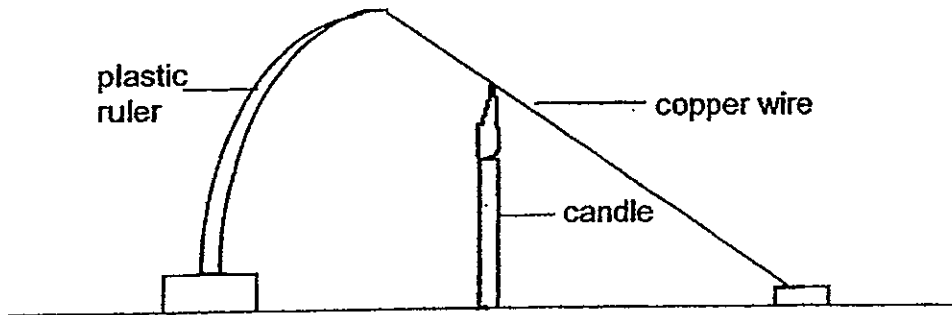

What would be observed about the plastic ruler after one minute?

- (1) The plastic ruler will break.
 - (2) The plastic ruler will become longer.
 - (3) The plastic ruler will bend less towards the right.
 - (4) The plastic ruler will bend more towards the right.
- 27 Which of the following processes does not require heat?
- A Frying a fish
 - B Forming a shadow
 - C Sweeping the floor
 - D Ironing a pair of shorts
- (1) A and B only
 - (2) B and C only
 - (3) C and D only
 - (4) A and D only

- 28 Gary has two cups of water of the same volume as shown below.

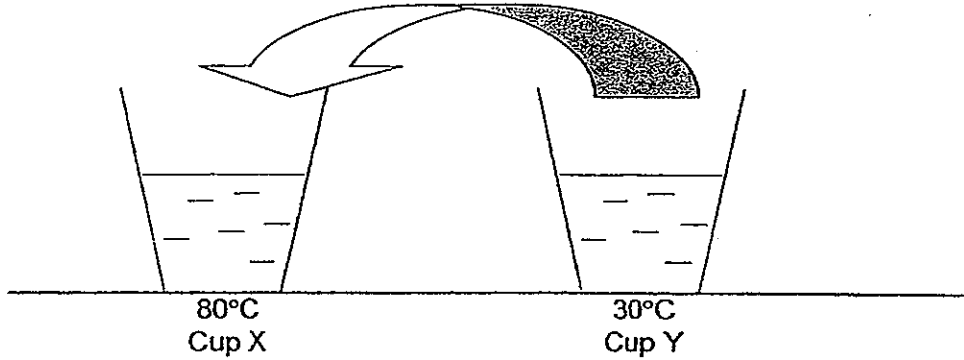

He poured the water from Cup Y into Cup X. What would likely be the new temperature of the water in cup X?

- (1) 30°C
 - (2) 50°C
 - (3) 80°C
 - (4) 100°C
- 29 During hot and sunny days, Elsie observes that the telephone wire hangs loosely at B, as shown in the diagram below.

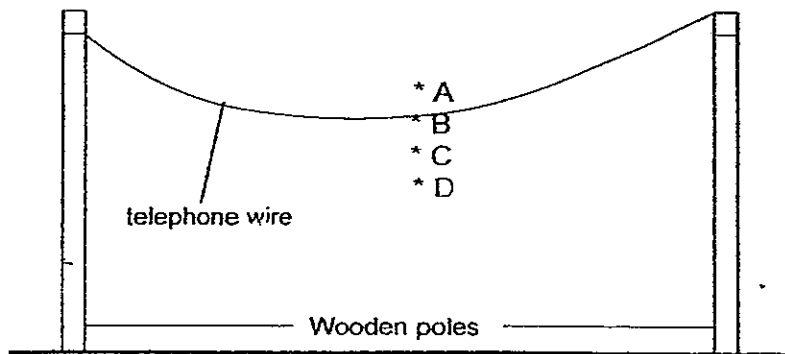

Which position, A, B, C or D, would the telephone wire be at during cold and rainy days?

- (1) A
- (2) B
- (3) C
- (4) D

- 30 Three square objects at positions P, Q and R were placed in a straight line. Light was shone as shown below to obtain a shadow on the screen.

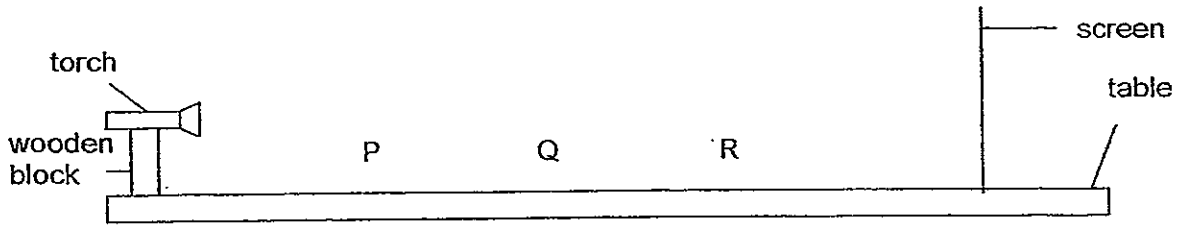



The table below describes the objects.

Object	Size of object (cm ²)	opaque	translucent	transparent
P	49			
Q	16			
R	25			

Which one of the following shadows is most likely to be correct?

Legend

Light shadow 

Dark shadow 

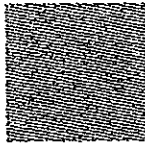
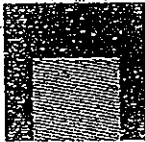
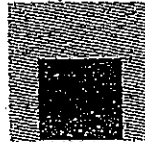
(1) 	(2) 
(3) 	(4) 



Anglo-Chinese School (Primary)

END-OF-YEAR EXAMINATION 2012
SCIENCE
PRIMARY FOUR
BOOKLET B

Name: _____ ()

Class: Primary 4 ____

Date: 1 November 2012

Duration of paper: 1 h 45 min

Parent's/Guardian's signature

INSTRUCTIONS TO CANDIDATES

1. This question paper consists of 14 printed pages including this cover page.
2. Do not turn over this page until you are told to do so.
3. Follow all instructions carefully.
4. Answer all questions.
5. Write your answers in this booklet.

Booklet	Maximum marks	Marks obtained
A	60	
B	40	
Total	100	

For questions 31 to 44, write your answers in the spaces provided in this booklet.

The number of marks available is shown in the brackets [] at the end of each question or part question. (40 marks)

31 The diagram below shows the human digestive system.

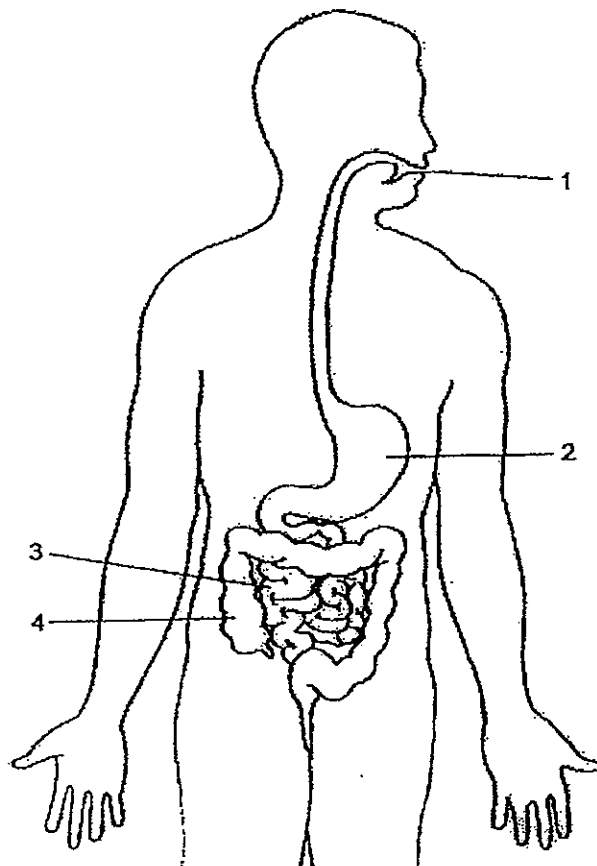

- (a) Using 1, 2, 3 and 4, identify the part where
- (i) Absorption of digested food takes place: _____ [1]
- (ii) There is no digestion: _____ [1]
- (b) Name the substance that digests part of the food at part 1. [1]

(Go on to the next page)

Score	3
-------	---

133

32 Study the diagram below carefully. Fill in each of the blanks with a suitable word.

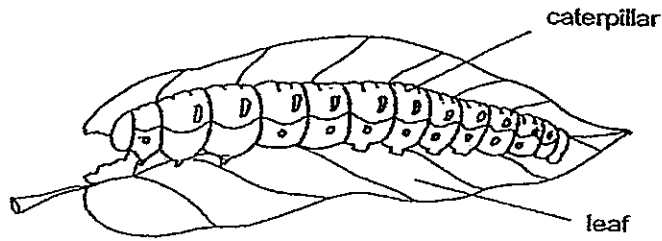

- (a) The caterpillar needs food, water and _____ to survive. [1]
- (b) The caterpillar eats leaves and becomes bigger after some time. This shows that it can _____. [1]

33 The diagram below shows the stages in the life cycle of a butterfly.

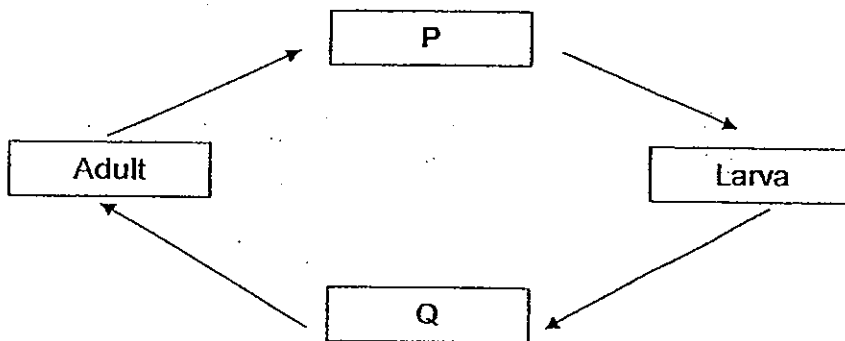

Choose the correct words from the box to answer the questions below.

caterpillar egg pupa nymph

Name the two stages P and Q

P: _____ [1]

Q: _____ [1]

(Go on to the next page)

Score	4
-------	---

34 Study the flowchart below carefully.

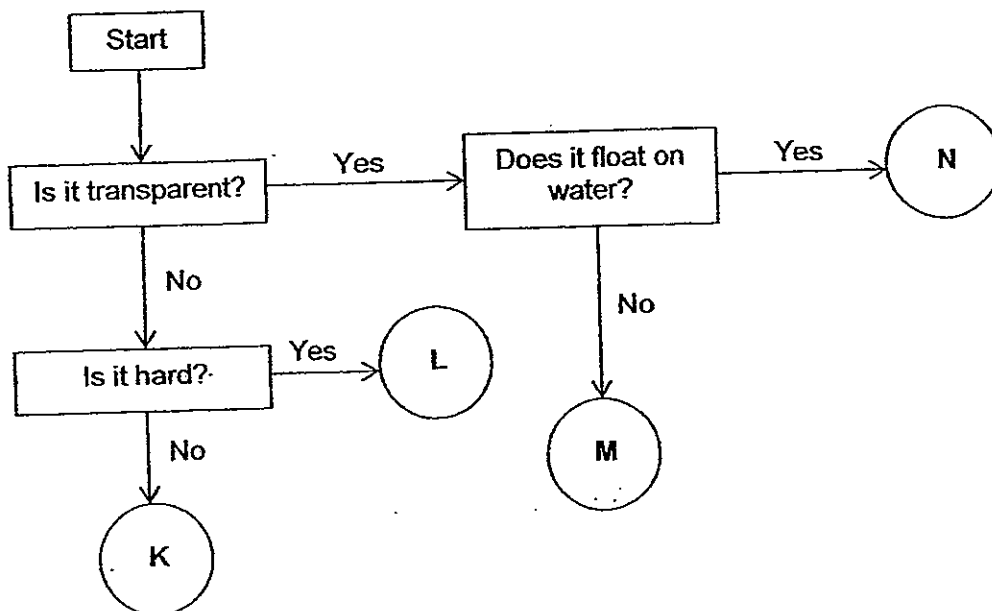

Using the given helping words as shown below, identify the objects K, L, M and N correctly. Each word can only be used once. [2]

Brick	Eraser	Glass rod	Plastic straw
-------	--------	-----------	---------------

K: _____

L: _____

M: _____

N: _____

(Go on to the next page)

Score	2
-------	---

135

- 35 Lynette conducted several experiments with substances X, Y and Z. She recorded her observations in the table below.

Properties	Substance X	Substance Y	Substance Z
Can it be compressed?	No	Yes	No
Does it have a definite shape?	No	No	Yes
Does it have a definite volume?	Yes	No	Yes

- (a) Which substance correctly describes sugar syrup? [1]

- (b) Which state of matter could substances X, Y and Z be in? [3]

X: _____

Y: _____

Z: _____

(Go on to the next page)

Score	4
-------	---

36

Zachary filled up Container A with 350 ml of water as shown in the diagram below. He then gently lowered a metal cube to the bottom of the container.

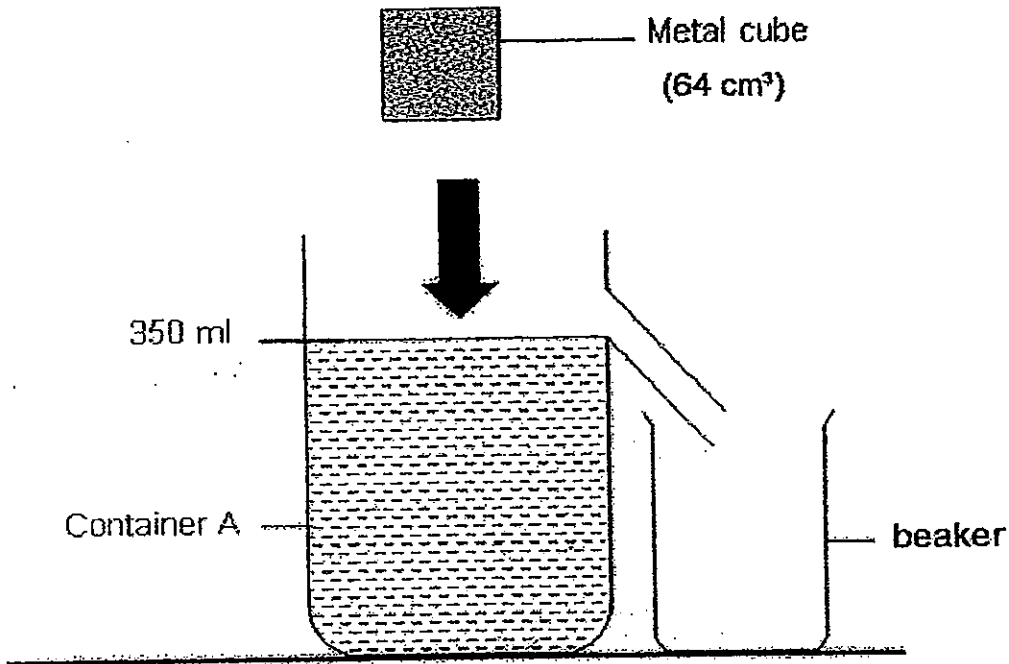

- (a) Will the amount of water that flowed out be more than, less than or equal to the volume of the cube? [1]

- (b) Explain why water flowed out of container A when the metal cube sank in completely. [1]

- (c) Zachary was told to measure the volume of water that flowed out of container A accurately. Which other apparatus can he use to replace the beaker? [1]

(Go on to the next page)

Score	3
-------	---

137

37 Julian conducted an experiment to determine if the amount of fertilizer given will increase the height of tomato plants over two weeks.

- (a) In the table below, put a tick for the variable/s that need to be constant throughout the experiment. [2]

Variables in the experiment	Must the variable be constant?
Type of tomato plants used	
Amount of fertilizers used	
Location where the plants were kept	
Amount of water each plant was given daily	

- (b) Julian recorded the results of the experiment and concluded that the best amount of fertilizer for the plant to grow tallest is 45 grams. In the bar graph below, draw out the missing bar to represent the height of the tomato plant when 35 grams of fertilizer were added. Use a pencil and a ruler to draw the shaded bar required. [1]

Height of plant (cm)

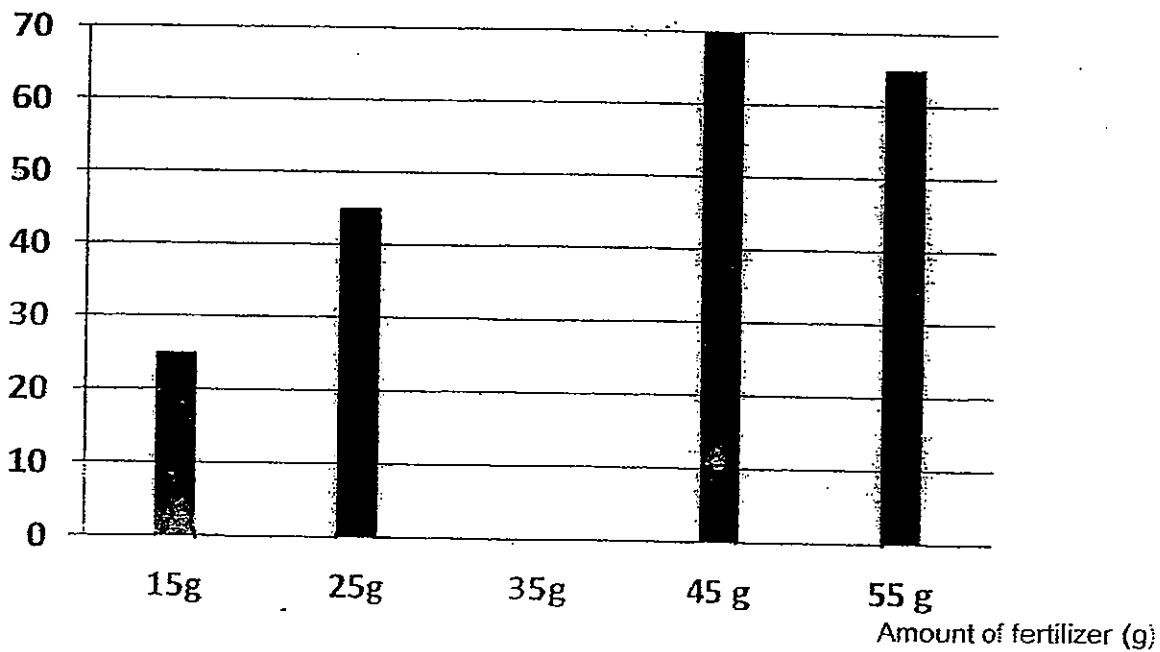

(Go on to the next page)

Score	3
-------	---

38 Jane sets up an experiment to create an electromagnet as shown in the diagram below.

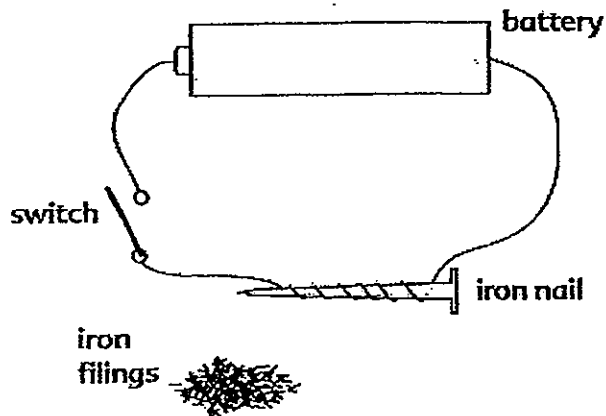

- (a) With a working battery and an iron nail as shown above, what should Jane do in order to create an electromagnet? [1]
- _____
- (b) State two ways to increase the magnetic strength of the electromagnet. [2]
- (1) _____
- (2) _____
- (c) State one use of electromagnets. [1]
- _____

(Go on to the next page)

Score	4
-------	---

139

- 39 Raymond placed some steel paper clips near a horseshoe magnet at three different positions, X, Y, and Z of the magnet. The results are shown in the bar graph below.

Number of paper clips attracted

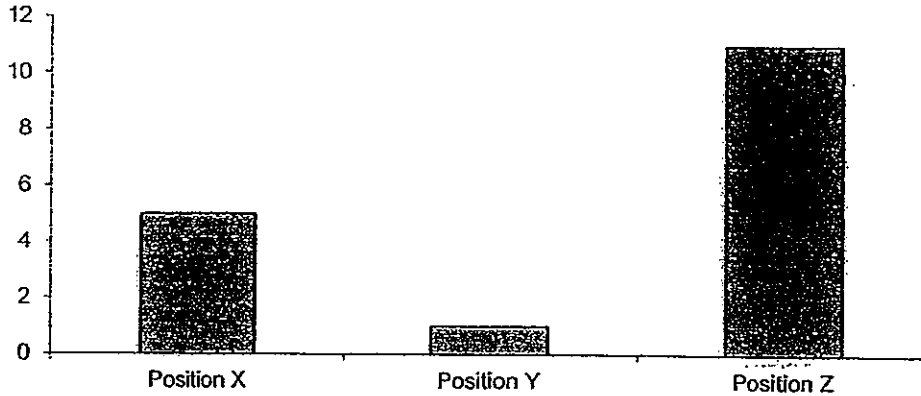

- (a) Based on the results above, label position X, Y and Z on the horseshoe magnet in the diagram below. [1]

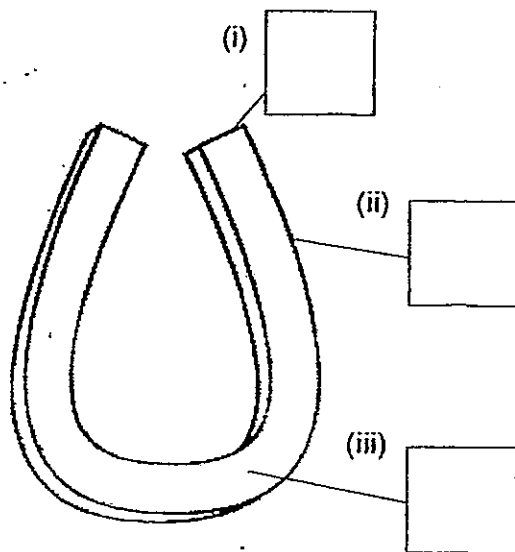

- (b) Based on the results obtained as shown in the graph above, what does this experiment tell you about the pull of the magnet? [1]

- (c) State one way to demagnetize the horseshoe magnet.

(Go on to the next page)

Score	3
-------	---

- 40 Bruce used an instrument to measure the temperature of water in a basin.

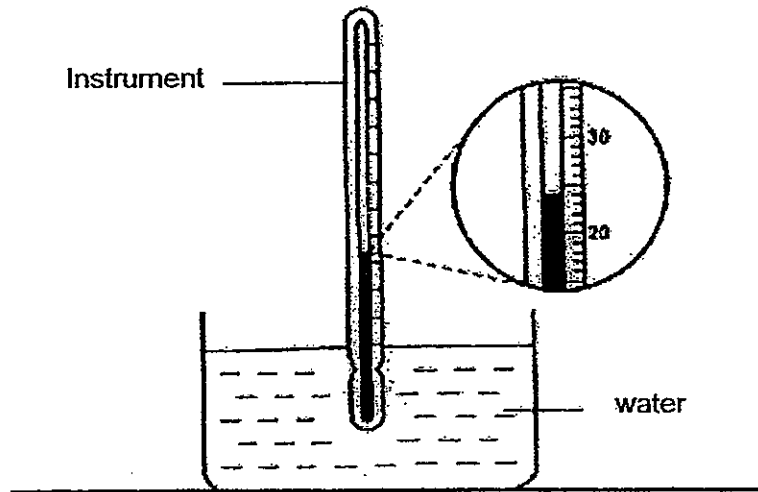

- (a) What is the instrument called? [1]

- (b) What is the recorded temperature of the water in the basin? [1]
_____ °C

(Go on to the next page)

Score	2
-------	---

141

41 Linda secured four bar magnets onto a table and made a track using two glass rods. Linda placed the track in the centre of the four bar magnets and also placed a rod magnet on the track as shown below.

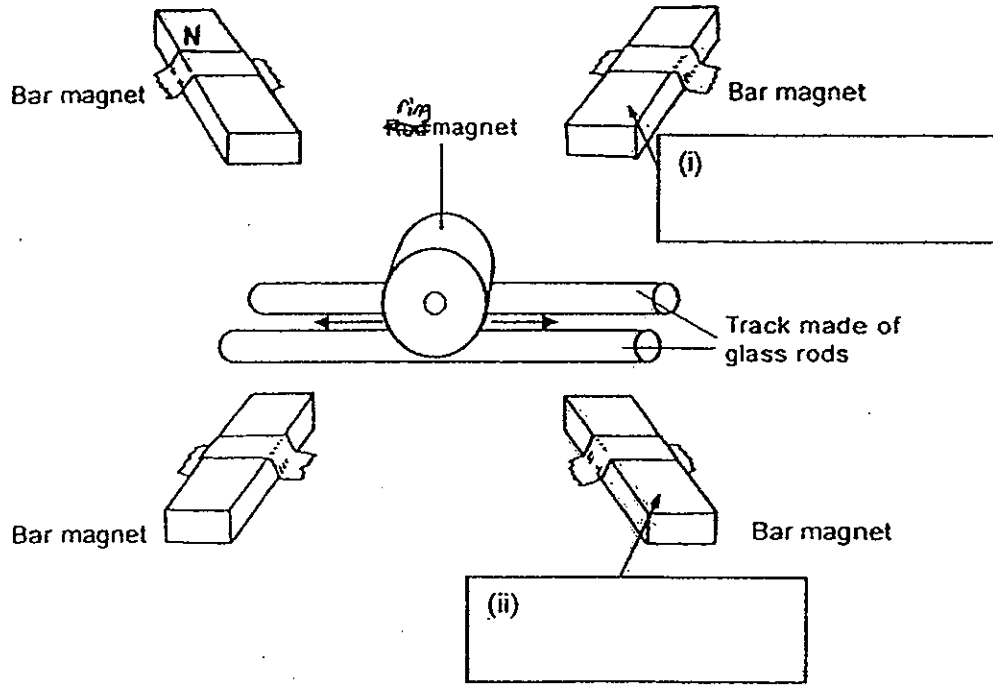

Then, she observed that the ~~rod~~^{rod} magnet moved back and forth for a while at the beginning of the experiment before finally coming to a stop in the middle of the track.

- (a) Label the poles of the bar magnets in the boxes (i) and (ii) provided above. [1]
- (b) What is the property of the magnets that caused the rod magnet to move back and forth at the beginning of the experiment? [1]

(Go on to the next page)

Score	2
-------	---

42 A flask in the set-up below is heated as shown in the diagram.

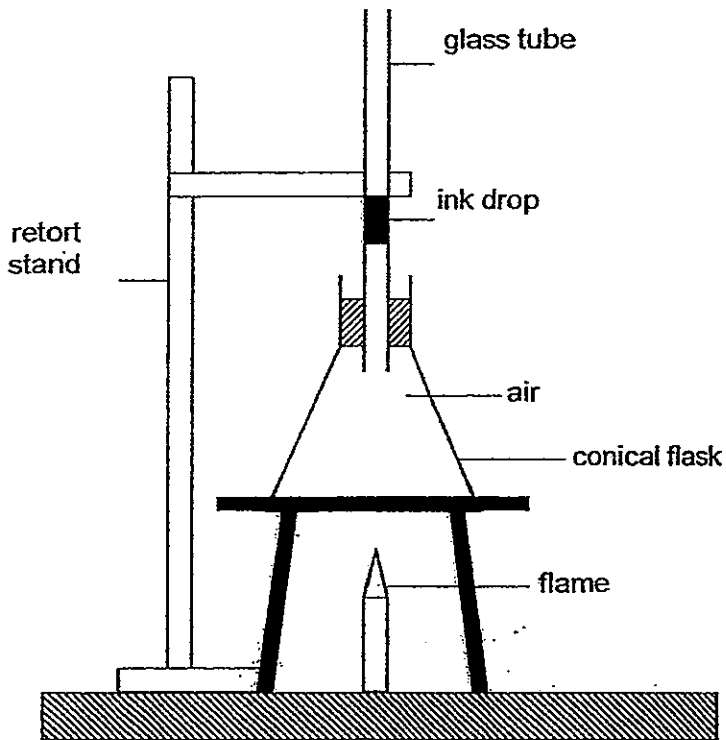

After heat was applied to the flask, it was observed that the ink drop dropped a little and then slowly rose. Explain why. [2]

(Go on to the next page)

Score	2
-------	---

143

- 43 Noah wanted to find out how fast wax balls will melt when they were placed at different points along a heated metal rod.

The graph below shows the time taken for the five identical wax balls to fall off the heated metal rod.

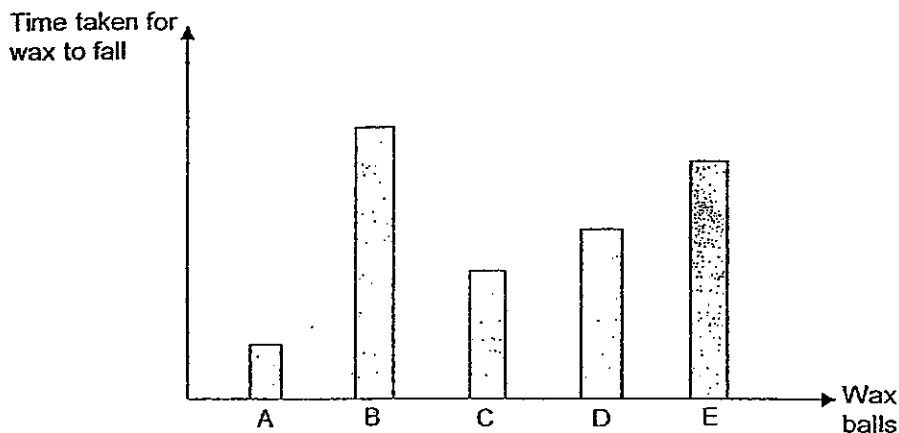

- (a) With reference to the graph above, indicate the positions of the wax balls before they fall off. Write the letters B, C, D and E in the boxes provided. The first one, Wax ball A has been done for you. [2]

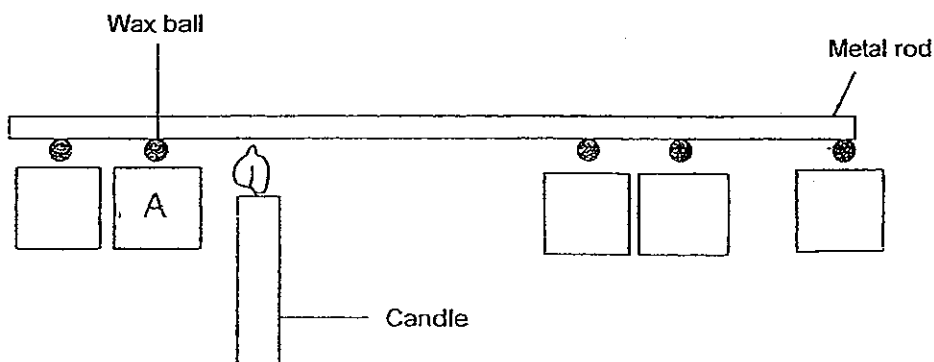

- (b) Explain why the wax balls dropped off in this order. [2]

(Go on to the next page)

Score	4
-------	---

- 44 Some crushed ice was taken out of the freezer and left in the open, as shown in the diagram below. The temperature reading of the set-up was recorded in the table below for every two minutes afterwards.

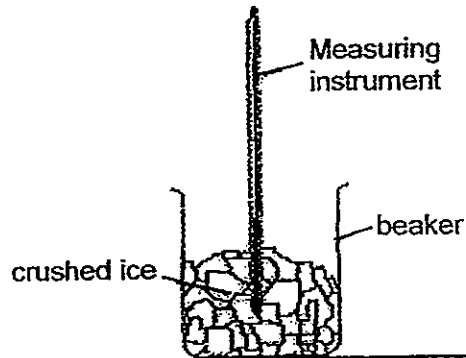

Time (min)	Temperature measured (°C)
0	0
2	0
4	0
6	0
8	2
10	5
12	10
14	23
16	28
18	28

Based on the table above,

- (a) The increase in temperature was highest between the _____ minute and the _____ minute of the experiment. [1]
- (b) What was the change in state from 0 to the 6th minute? Explain how that happened. [2]
- _____
- (c) Based on given results in the table above, what is the likely temperature of the surrounding in the open? [1]
- _____

- End of Booklet B -

145	Score	4
-----	-------	---

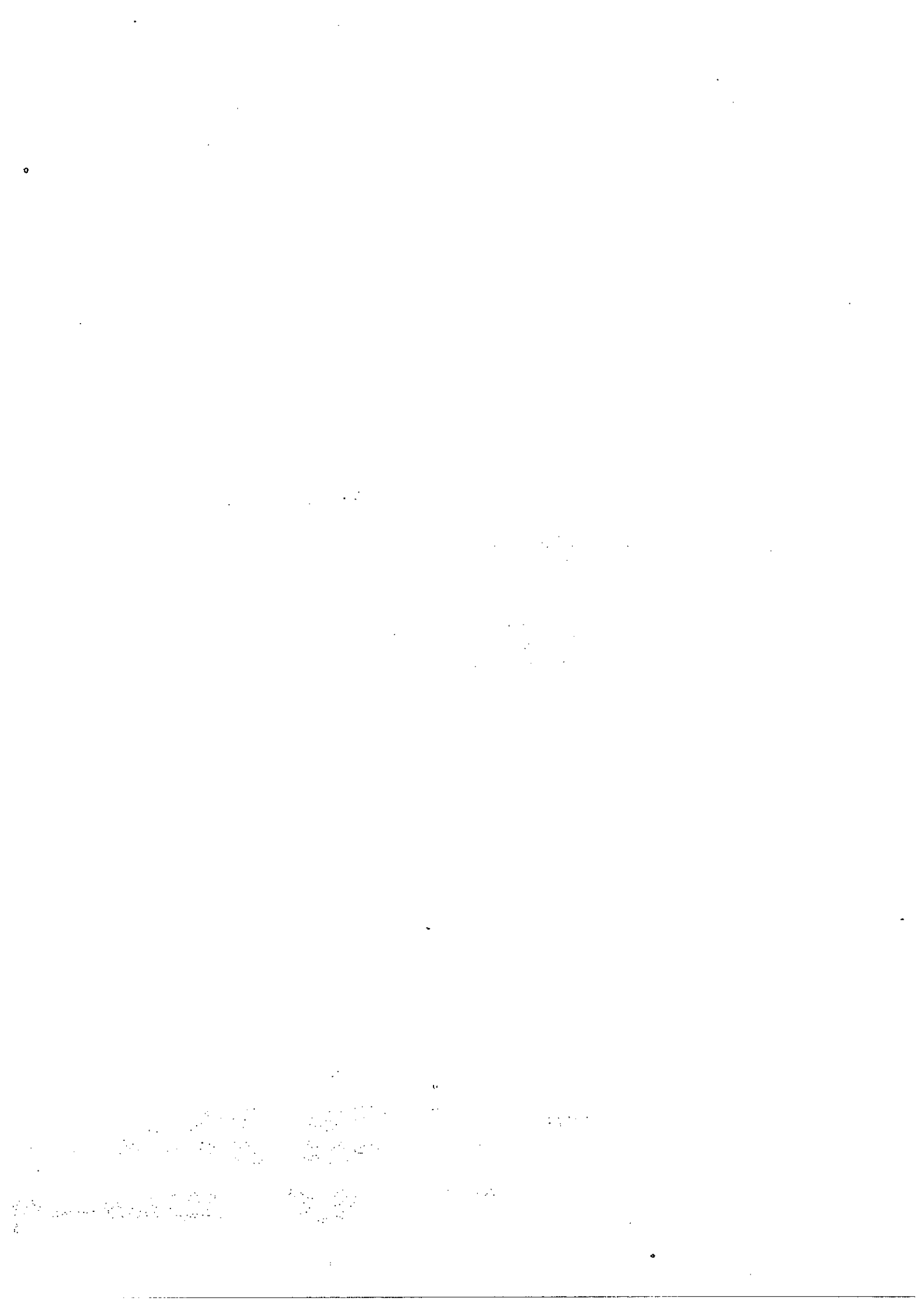

ANSWER SHEET

EXAM PAPER 2012

SCHOOL : ACS
 SUBJECT : PRIMARY 4 SCIENCE
 TERM. : SA2

Q1	Q2	Q3	Q4	Q5	Q6	Q7	Q8	Q9	Q10	Q11	Q12	Q13	Q14	Q15	Q16	Q17
1	3	3	1	1	2	1	4	2	3	1	2	2	2	2	3	3

Q18	Q19	Q20	Q21	Q22	Q23	Q24	Q25	Q26	Q27	Q28	Q29	Q30
1	4	1	3	2	2	4	2	3	2	2	1	4

31)a)i)3 ii)4 b)Saliva

32)a)air b)grow

33)P: egg Q: pupa

34)K: Eraser L: Brick M: Glass rod N: Plastic straw

35)a)Substance X b)X: Liquid Y: Gas Z: Solid

36)a)Equal.

- b)The medal cube occupies space so when it sank water has do flow out.
- c)A measuring cylinder.

37)a)Type of tomato plants used

Location where the plants were kept

Amount of water each plant was given daily

b)

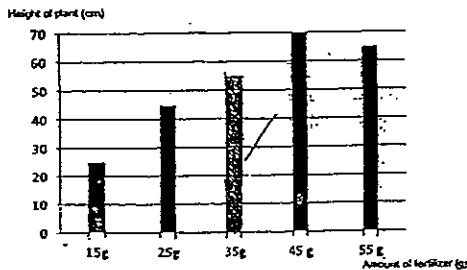

38)a)Close the switch.

b)1)Increase the number of coils.

2)Increase the number of batteries.

c)Door stopper.

39)a)i)Z ii)X iii)Y

b)The pull of the magnet is strongest at its poles.

c)Heat it.

40)a)Thermometer.

b)24°C.

41)a)i)South ii)South

b)Like poles repel.

42)The heat from the flame reaches the conical flask first, causing it to gain heat and expand slightly, hence the ink drops slightly. After the heat reaches the air in the flask, the air in the flask gained heat and expanded, causing the ink to rise.

43)a)C A D E B

b)As heat travels from a hotter region to a colder region, heat from the flame first reaches wax A which is the nearest, causing it to melt and fall followed by the next nearest wax, C then D, E, B.

44)a)12 14

b)The change in state was from solid to liquid. The ice gained heat from the surrounding and melted.