

Name: _____ ()

23 August 2012

Class: P 6 _____



CATHOLIC HIGH SCHOOL
PRIMARY SIX
PRELIMINARY EXAMINATION 2
PAPER 1
(BOOKLET A)

15 questions

20 marks

Total Time for Booklets A and B: 50 min

INSTRUCTIONS TO CANDIDATES

Do not open this booklet until you are told to do so.

Follow all instructions carefully.

Shade your answers in the Optical Answer Sheet (OAS) provided.

You are **not** allowed to use a calculator.

Answer all questions.

Questions 1 to 10 carry 1 mark each. Questions 11 to 15 carry 2 marks each.
For each question, four options are given. One of them is the correct answer.
Make your choice (1, 2, 3 or 4). Shade the correct oval on the Optical Answer Sheet.
All diagrams are not drawn to scale. (20 marks)

1. Which of the following is fifty-four thousand and thirty-two in figures?

- (1) 5 432
 - (2) 54 032
 - (3) 504 032
 - (4) 540 032
-

2. Round off 594 740 to the nearest thousand.

- (1) 590 000
 - (2) 594 000
 - (3) 595 000
 - (4) 600 000
-

3. Which of the following has the greatest value?

- (1) $\frac{5}{11}$
 - (2) $\frac{2}{3}$
 - (3) 0.677
 - (4) 6.75 %
-

4. Find the value of $392 \div 800$.

- (1) 0.49
- (2) 2.04
- (3) 49
- (4) 149

5. The length of a basketball court is approximately _____.

- (1) 3 m
 - (2) 3 km
 - (3) 30 cm
 - (4) 30 m
-

6. Find the difference in value between 3 tenths and 25 hundredths.

- (1) 0.05
 - (2) 0.22
 - (3) 0.275
 - (4) 0.55
-

7. Express 2 kg 3 g in kilograms.

- (1) 0.23 kg
 - (2) 2.003 kg
 - (3) 2.03 kg
 - (4) 2.3 kg
-

8. Mrs Tan made 18 cakes. She gave each of her students $\frac{2}{3}$ of a cake. There was no cake leftover. How many students did she give the cakes to?

- (1) 8
 - (2) 12
 - (3) 18
 - (4) 27
-

(Go to the next page)

9. The figure below shows the net of a cube. Which two faces are opposite to each other?

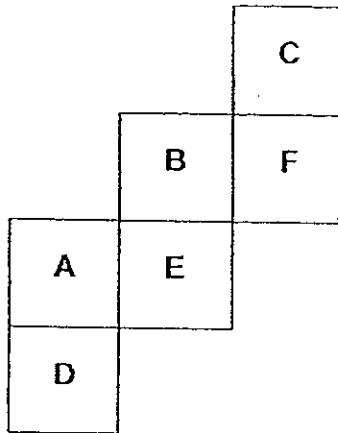

- (1) A and C
(2) B and D
(3) C and D
(4) D and E
-
10. What is the maximum number of 2-cm cubes that can be packed into a rectangular box measuring 16 cm by 11 cm by 6 cm?
- (1) 16
(2) 120
(3) 132
(4) 528
-
11. All items in a sports shop were sold at 20% discount. Gabriel bought a basketball for \$120. What was the original price of the basketball?
- (1) \$96
(2) \$144
(3) \$150
(4) \$180

12. The figure shows the position of Ivan and some facilities around him.

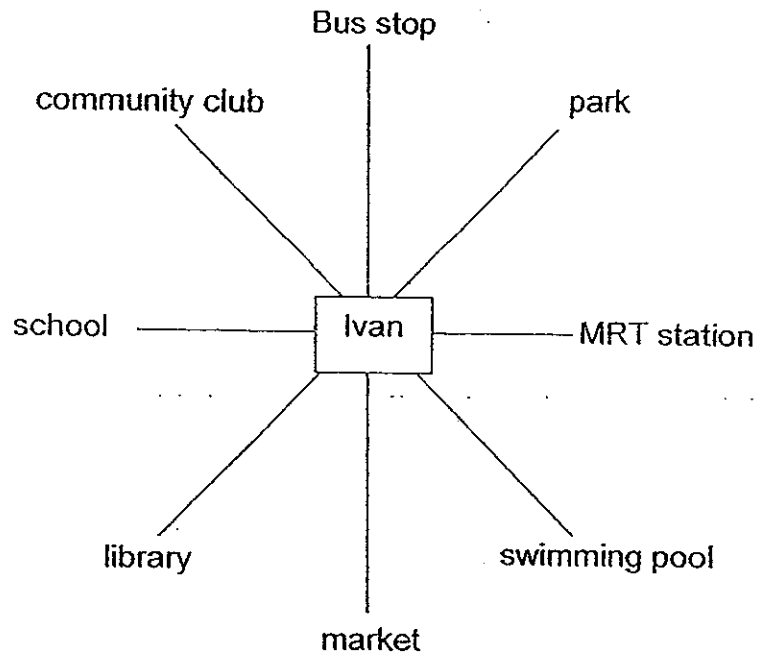

Ivan would be facing the swimming pool if he made a 225° clockwise turn. Where would he be facing if he made a 45° anti-clockwise turn instead?

- (1) park
 - (2) market
 - (3) school
 - (4) library
-
13. Marc shared some chicken nuggets with a group of friends. If he gave each person 4 nuggets, he would have 5 nuggets left. If he gave each person 5 nuggets, he would be short of 3 nuggets. How many nuggets did he have?

- (1) 13
- (2) 32
- (3) 37
- (4) 42

14. The table shows the parking charges for a vehicle in a car park.

Vehicle parking charges	
For the first hour	\$2.50
For every additional half hour or part thereof	\$1.20

Zachary parked his car at the car park and paid \$10.90. What was his longest possible duration of parking?

- (1) $3\frac{1}{2}$ h
- (2) 4 h
- (3) $4\frac{1}{2}$ h
- (4) 8 h
-
15. In a flower vase, each flower has either 3 or 5 petals. If the ratio of the number of flowers to the number of petals is 7 : 23, what fraction of the flowers have 5 petals?
Express your answer in the simplest form.

- (1) $\frac{1}{7}$
- (2) $\frac{3}{7}$
- (3) $\frac{5}{7}$
- (4) $\frac{6}{7}$

END OF BOOKLET A

(Go to the next page)

Name: _____ ()

23 August 2012

Class: P 6 _____



CATHOLIC HIGH SCHOOL

PRIMARY SIX

PRELIMINARY EXAMINATION 2

MATHEMATICS

PAPER 1

(BOOKLET B)

15 questions

20 marks

Total Time for Booklets A and B: 50 min

Booklet A	
Booklet B	
Total	

INSTRUCTIONS TO CANDIDATES

Do not turn over this page until you are told to do so.

Follow all instructions carefully.

Answer all questions.

Show your working clearly as marks are awarded for correct working.

Write your answers in this booklet.

You are not allowed to use a calculator.

Questions 16 to 25 carry 1 mark each. Write your answers in the spaces provided. For questions which require units, give your answers in the units stated. (10 marks)

Do not write
in this spac

16. Simplify $3k - 29 + 15k \div 3$.

Ans: _____

17. Find the value in the blank.

$$\square \times 39 + 82 \times 39 = 39 \times 100$$

Ans: _____

18. Write down all the common factors of 24 and 32.

Ans: _____

19. The figure below is made up of 7 identical squares. Draw a line of symmetry in the figure below.

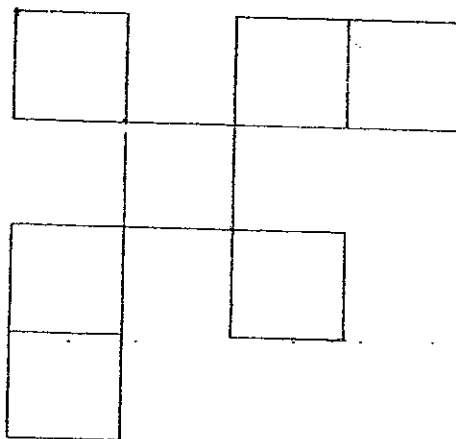

20. An empty tank is filled with water from a tap at a constant rate. At 10.00 a.m., the tank is $\frac{1}{2}$ full. At 11.00 a.m., the tank is $\frac{2}{3}$ full. How many hours does it take for the tank to be filled to the brim with water?

Ans: _____ h

21. Mr Lee drove from Singapore and arrived at Kota Tinggi at 13 20. At what time did he leave Singapore if the drive took 2 h 30 min? Express your answer in 24-hour clock.

Ans: _____

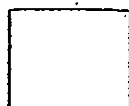
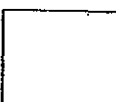
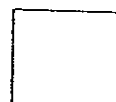

22. The total surface area of a cube is 150 cm^2 . What is the length of the cube?

Do not write
in this space

Ans: _____ cm

23. Jayden painted $\frac{1}{4}$ of a pole red and $2\frac{2}{5}$ m of the pole blue. If the pole was 8 m long, what was the length of the pole that was not painted?

Ans: _____ m

24. $\frac{2}{3}$ of Kim's marbles was equal to $\frac{1}{6}$ of Wendy's marbles. What is the ratio of the number of marbles Kim had to the total number of marbles the two children had?
Express your answer in simplest form.

Do not write
in this space

Ans: _____

25. Ashley stacked 4 identical cubes at a corner of a room and then painted them. What was the total number of faces of the cubes that he was not able to paint?

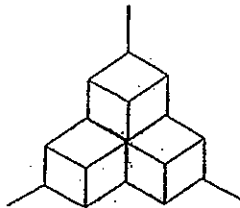

Ans: _____

Total marks for questions 16 to 25
(Go to the next page)

Questions 26 to 30 carry 2 marks each. Show your working and write your answers in the spaces provided. For questions which require units, give your answers in the units stated. (10 marks)

Do not write in this space

26. Express $\frac{5}{9}$ as a decimal and correct the answer to 2 decimal places.

Ans: _____

27. The average age of 4 adults is 30 years old. When John's age is added, the average age increases to 35 years old. How old is John?

Ans: _____ years old

28. A basket can hold either 18 potatoes or 24 onions. If there are already 12 potatoes in the basket, how many onions can be placed in the basket?

Ans: _____

29. In the figure below, BCFG is a square. If $BD = 22$ cm and $HF = 6$ cm, what is the perimeter of the rectangle ADEH?

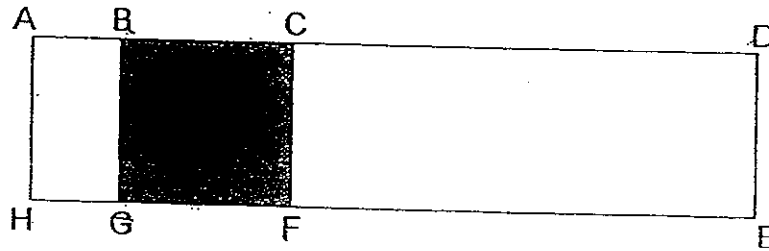

Ans: _____ cm

Do not write in this space

30. In the figure below, AC, AD, BD, BE and CE are straight lines. Find $\angle DAC$.

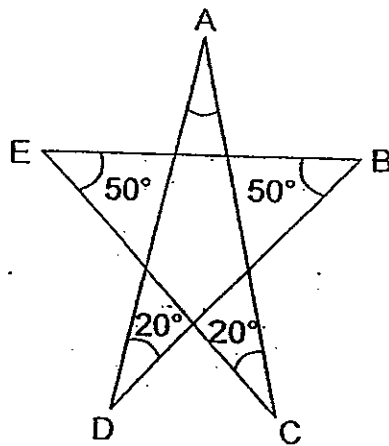

Ans: _____ °

Total marks for questions 26 to 30

END OF BOOKLET B
END OF PAPER 1

Name : _____

23 August 2012

Class : P 6 _____



CATHOLIC HIGH SCHOOL
PRELIMINARY EXAMINATION 2
PRIMARY SIX
MATHEMATICS
PAPER 2

Paper 1 Booklet A	20
Paper 1 Booklet B	20
Paper 2	60
Total Marks	100

Total Time: 1 h 40 min

Parent's Signature: _____

INSTRUCTIONS TO CANDIDATES

Do not turn over this page until you are told to do so.

Follow all instructions carefully.

Answer all questions.

Show your working clearly as marks are awarded for correct working.

Write your answers in this booklet.

You are allowed to use a calculator.

Questions 1 to 5 carry 2 marks each. Show your working clearly and write your answers in the spaces provided. For questions which require units, give your answers in the units stated. All diagrams are not drawn to scale. (10 marks)

Do not write in this space

1. In the figure below, ABCD is a trapezium and AQDP is a rhombus. $\angle ADQ = 55^\circ$ and $\angle BAQ = 21^\circ$. Find $\angle QDC$.

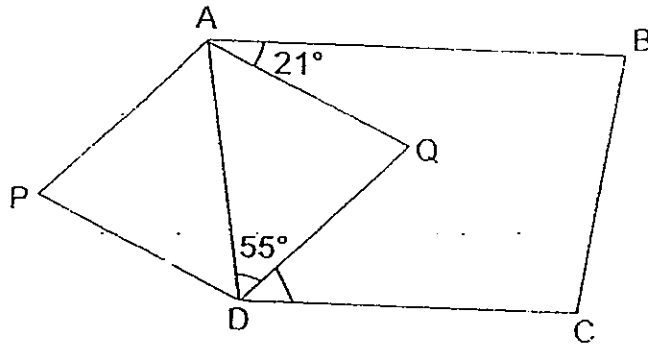

Ans: _____ °

2. The ratio of the number of books Javier had to the number of books Mitchell had was 5 : 8. Javier had 21 books fewer than Mitchell. How many books did the two boys have altogether?

Ans: _____

3. Zachary is now $24p$ years old. He is thrice as old as Benedict. Find their total age 4 years ago.
Express your answer in terms of p in the simplest form.

Do not write
in this space

Ans: _____ years old

4. The pattern in the box shows part of a tessellation. Extend the tessellation by drawing two more unit shapes in the space provided in the box.

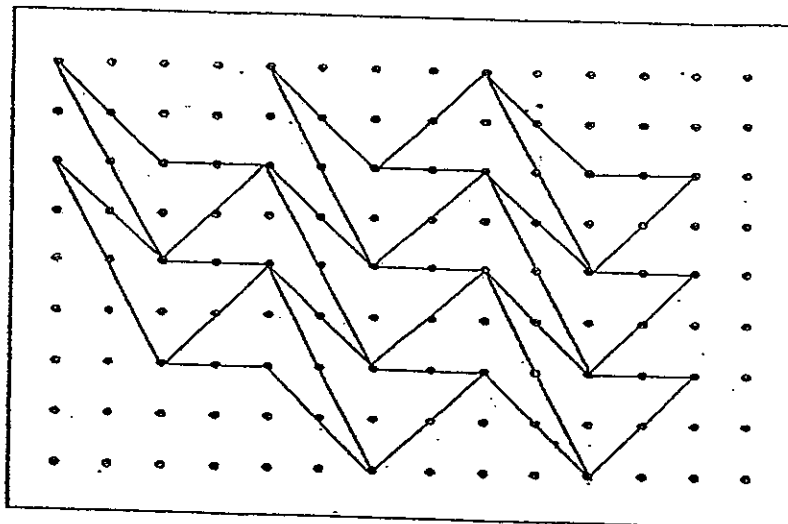

5. In the figure, OR, OP, PQ and QR are straight lines. The points O, P, Q and R are the centres of the four circles. The radius of each circle is 15 cm. Find the total perimeter of the shaded parts. Express your answer in terms of π .

Do not v
in this st

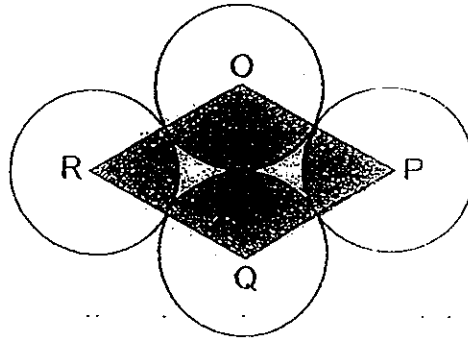

Ans: _____ cm



For questions 6 to 18, show your working and write your answers in the spaces provided. The number of marks available is shown in brackets [] at the end of each question or part-question. All diagrams are not drawn to scale. (50 marks)

Do not write in this space

6. Andrew has some red, blue and green stickers. The number of red stickers is $\frac{4}{9}$ of the total number of stickers. The number of blue stickers is $\frac{3}{8}$ of the number of red stickers. Given that the number of green stickers is 36 fewer than the red stickers, how many stickers does Andrew have altogether?

Ans: _____ [3]

7. In the figure, ABC and EBC are triangles. $CD = DE$, $\angle BCD = 65^\circ$ and $\angle ADE = 50^\circ$. Find $\angle DEB$.

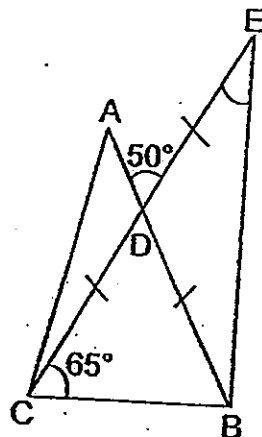

Ans: _____ [3]

8. 40% of a class of 40 pupils has a Facebook account. 50% of the pupils with Facebook account and 25% of those without a Facebook account have a Gmail account. How many pupils in the class have a Gmail account?

Do not write
in this space

Ans: _____ [3]

9. Box A contains only 50¢ coins while Box B contains only 10¢ coins. There are 23 more coins in Box B than in Box A. If the total amount of money in Box A and Box B is \$13.10, how many coins are there altogether?

Ans: _____ [3]

10. ABC is a triangle. Draw two lines, AD and BD, where AD is parallel to BC and BD is perpendicular to BC. Do not write in this space

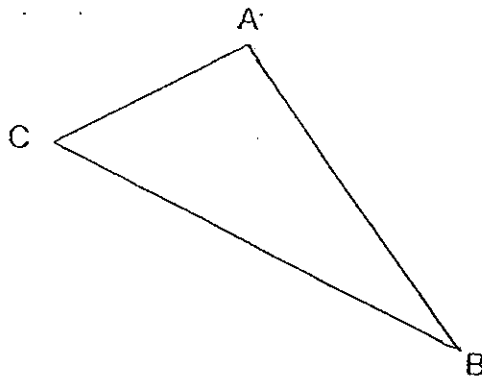

[3]

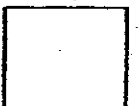

11. Jayden received some pocket money. He spent $\frac{3}{5}$ of his pocket money on food and $\frac{3}{10}$ of the remainder on stationery. He saved the rest of the money. If his savings was \$28, how much pocket money did he receive?

Do not write
in this space.

Ans: _____ [4]

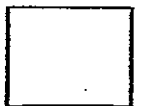

12. The pie chart represents the favourite food of the members of the concert band. An equal number of members chose chicken wings and chicken nuggets.

Do not write
in this space

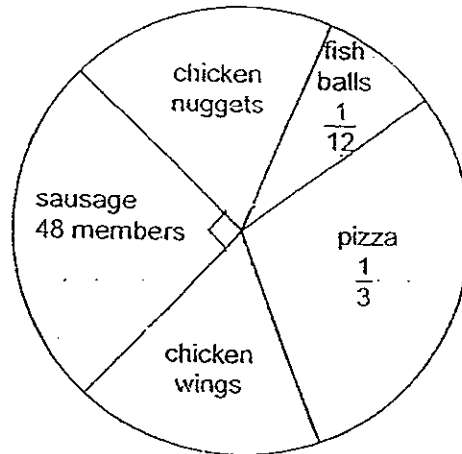

- (a) What fraction of the members chose chicken nuggets as their favourite food?

- (b) How many members chose pizza as their favourite food?

Ans: (a) _____ [2]

(b) _____ [2]



13. The following figures are made up of unit cubes stacked at a corner of a room and painted. The first three figures are shown below.

Do not write in this space.

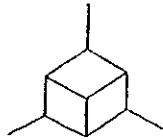

Figure 1

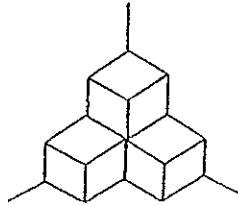

Figure 2

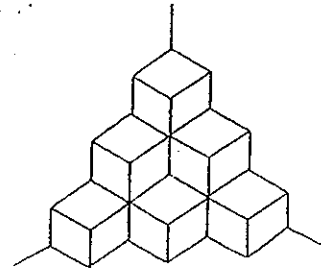

Figure 3

Figure number	Number of cubes	Number of faces of the cubes that are painted
1	1	3
2	4	9
3	10	18
4		

- (a) Complete the table for Figure 4. Find the number of cubes and the number of faces of the cubes that are painted. [2]

- (b) In which figure number would 165 faces of the cubes be painted?

Ans: (b) _____ [2]

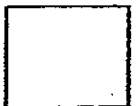

14. Ashley drove from Pasir Ris to Tuas at a uniform speed of 60 km/h. At the same time, Benjamin drove from Tuas to Pasir Ris in the opposite direction at a uniform speed. 15 minutes after they passed each other, Benjamin reached Pasir Ris while Ashley was still 9 km away from Tuas. If Benjamin took 35 minutes to travel from Tuas to Pasir Ris, what was the distance between Pasir Ris and Tuas?

Do not write
in this space

Ans: _____ [4]

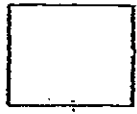

15. The figure is made up of a rectangle and a semicircle.
The area of the rectangle is 392 cm^2 . What is the area of the semicircle?
(Take $\pi = 3.14$)

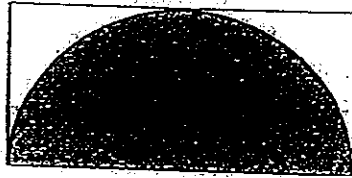

Do not write
in this space.

Ans: _____ [4]



16. A rectangular tank measuring 250 cm by 40 cm by 100 cm was $\frac{1}{4}$ filled with water. Tap A was then fitted and had water flowing into the tank at a rate of 5 litres per minute and Tap B had water drained out from the tank at a rate of 2 litres per minute. Tap A was turned on for 3 minutes and then it was turned off. Immediately after Tap A was turned off, Tap B was turned on for 3 minutes and then it was turned off. The 2 steps were repeated until the tank was completely filled without water overflowing. How long did it take for the tank to be filled?

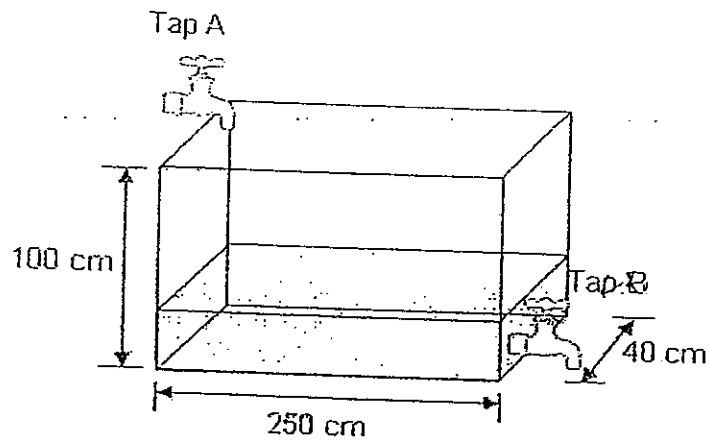

Do not write
in this space

Ans: _____ [5]

17. Frederic had a candy bag which contained 35 chocolate bars and 50 sweets. Ryan had another candy bag which contained 45 chocolate bars and 10 sweets. After Frederic gave Ryan some chocolate bars and sweets, 40% of Frederic's candy bag contained chocolate bars and 30% of Ryan's candy bag contained sweets. How many chocolate bars and sweets did Frederic give to Ryan altogether?

Do not write
in this space.

Ans: _____ [5]

18. A fruit seller packed some oranges into 22 big carton boxes and 8 small carton boxes. There were 14 more oranges in a big carton box than in a small box. The ratio of number of oranges packed into big carton boxes to the number of oranges packed into small carton boxes was 3 : 1. How many oranges did the fruit seller pack altogether?

Do not write in this space

Ans: _____ [5]



END OF PAPER.
PLEASE CHECK YOUR WORK CAREFULLY.

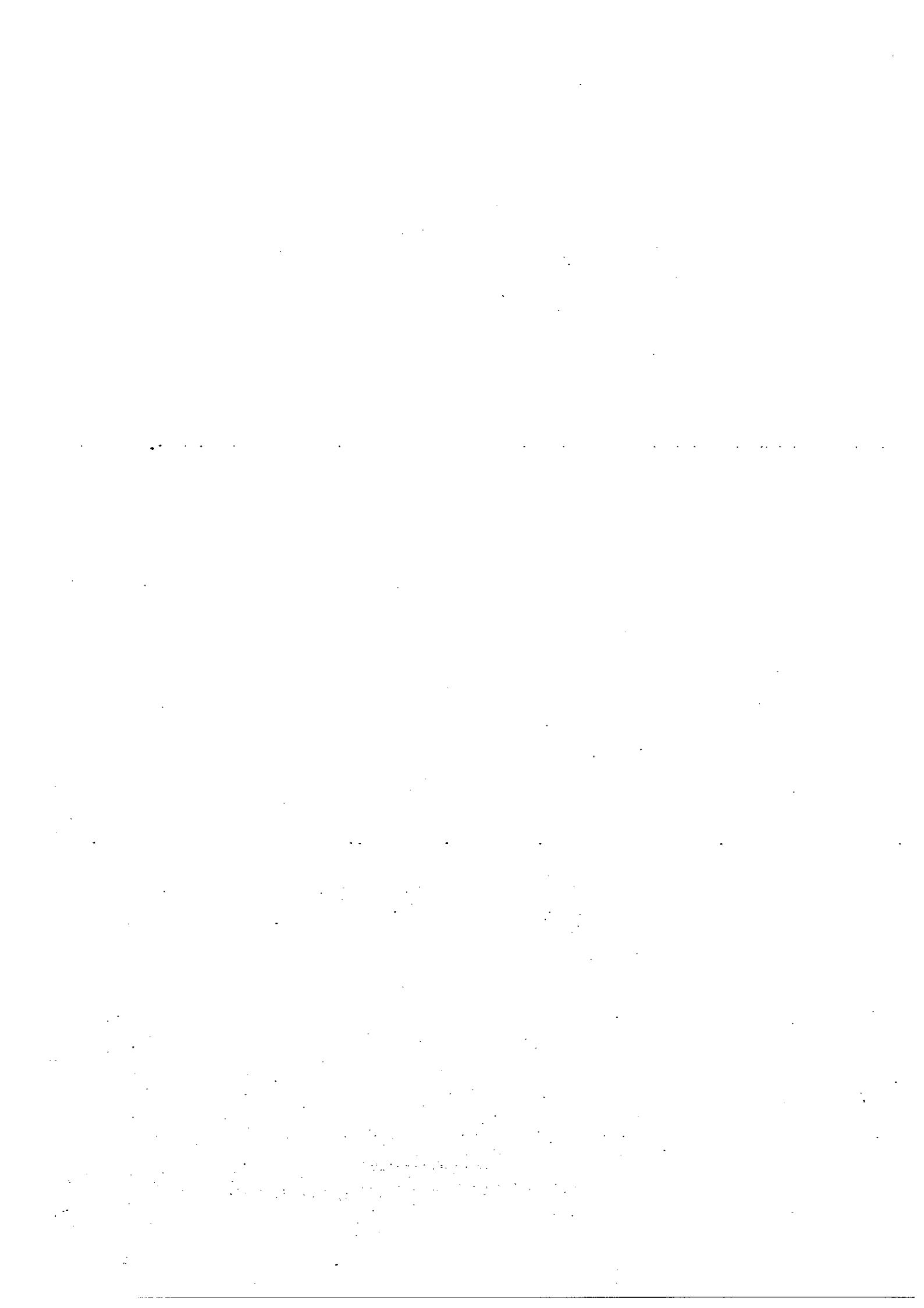

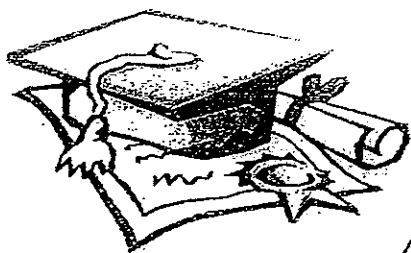

ANSWER SHEET

EXAM PAPER 2012

SCHOOL : CATHOLIC HIGH
SUBJECT : PRIMARY 6 MATHS

TERM : PRELIMINARY 2

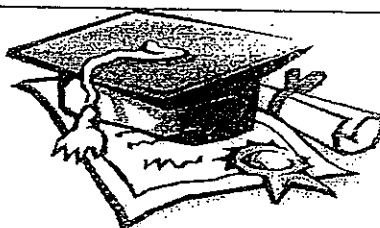

Paper 1

Q1	Q2	Q3	Q4	Q5	Q6	Q7	Q8	Q9	Q10	Q11	Q12	Q13	Q14	Q15
2	3	3	1	4	1	2	4	2	2	3	2	3	3	1

- 16 $8k - 29$
17 18
18 1,2,4,6,8
19

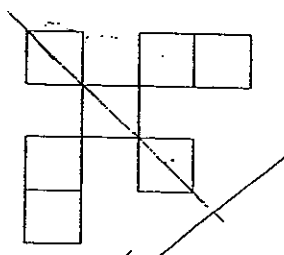

- 20 6h
21 10 50
22 5cm
23 $5 \frac{7}{20}$
24 1:05
25 15
26 0.6
27 55
28 8
29 56cm
30 40°

Paper 2

- 1 Angle DAQ = 55°
Angle AQD = $180^\circ - 55^\circ - 55^\circ = 70^\circ$

EXAM PAPER 2012

SCHOOL : CATHOLIC HIGH
SUBJECT : PRIMARY 6 MATHS

TERM : PRELIMINARY 2

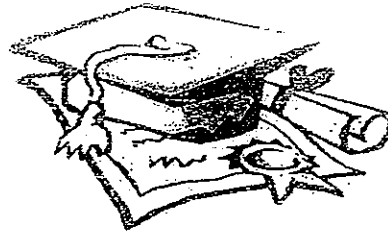

$$\text{Angle QDC} = 70^\circ - 21^\circ = 49^\circ$$

2

$$8 - 5 = 3$$
$$3 \text{ unit} = 21$$
$$1 \text{ unit} = 7$$
$$\text{Total unit} = 8 + 5 = 13$$
$$\text{Total books} = 13 \times 7 = 91$$

3

$$\text{Zachary} = 24\text{p}$$
$$\text{Benedict} = 24\text{p} \div 3 = 8\text{p}$$

4 years ago:

$$\text{Zachary} = 24\text{p} - 4$$
$$\text{Benedict} = 8\text{p} - 4$$
$$\text{Total age} = 24\text{p} - 4 + 8\text{p} - 4$$
$$= 32\text{p} - 8$$

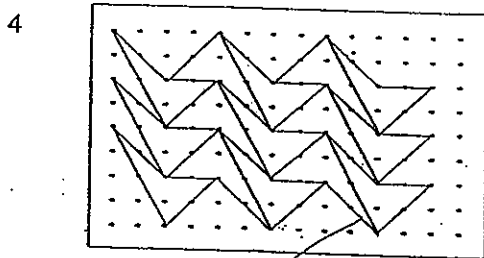

5

$$\text{Perimeter} = 2[\square]r + 8 \times 15$$
$$= 30[\square] + 120 \text{ cm}$$

6

$$\text{Red : Total} = 4 : 9 = 8 : 18$$
$$\text{Blue : Red} = 3 : 8$$
$$18 - 3 \cdot 8 = 7$$
$$8 - 7 = 1$$
$$1 \text{ unit} = 36$$
$$18 \text{ unit} = 36 \times 18 = 648$$

7

$$\text{Angle BDE} = (360^\circ - 50^\circ - 50^\circ) \div 2 = 130^\circ$$
$$\text{Angle DEB} = (180^\circ - 130^\circ) \div 2 = 25^\circ$$

8

$$\text{Pupils with facebook account} = 40 \times 40/100 = 16$$
$$\text{Pupils with facebook and gmail account} = 16 \times 50/100 = 8$$
$$\text{Pupils without facebook but has gmail account} = (40 - 16) \times 25/100 = 6$$
$$\text{Total} = 8 + 6 = 14$$

EXAM PAPER 2012

SCHOOL : CATHOLIC HIGH
SUBJECT : PRIMARY 6 MATHS

TERM : PRELIMINARY 2

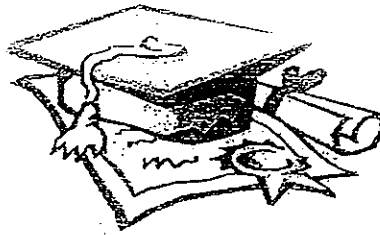

9 $23 \times \$0.10 = \2.30
 $\$13.10 - \$2.30 = \$10.80$

At 10.80, both Box A and Box B have the same number of coins.

Ratio of value in Box A to Box B = 5:1

Total unit = 6

1 unit = $\$10.80 \div 6 = \1.80

5 unit = $\$1.80 \times 5 = \9

Number of coins in Box A = $\$9 \div \$0.50 = 18$ coins

Number of coins in Box B = $\$1.80 \div \$0.10 + 23 = 41$ coins

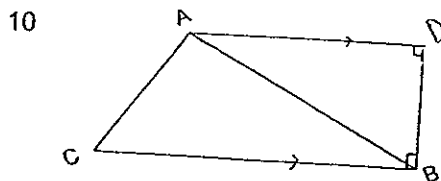

11 $2/5 \times 7/10 = 7/25$
 $28 \div 7 = 4$
 $4 \times 25 = \$100$

12a $12/12 - 4/12 - 1/12 - 3/12 = 4/12$
 $4/12 \div 2 = 1/6$

12b $48 \div 3 = 16$
 $16 \times 4 = 64$

13a Number of cubes = 20
Number of faces = 30

13b 10

14 15 minutes travelled by Ashley = $15/60 \times 60 = 15$ Km
Time taken to travel 9km + 15km by Benjamin = 35min - 15min = 20min
ie: Benjamin travelled 24km in 20 min
Total distance between Tuas and Pasir Ris : $35/20 \times 24$ km = 42km

15 $392 \times 2 = 784$
 $\sqrt{784} = 28$
Radius = $28 \div 2 = 14$ cm

EXAM PAPER 2012

SCHOOL : CATHOLIC HIGH
SUBJECT : PRIMARY 6 MATHS

TERM : PRELIMINARY 2

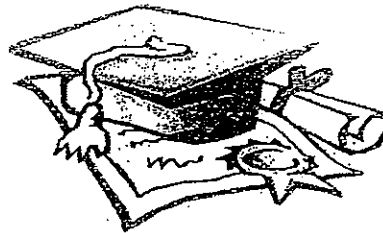

$$\begin{aligned}\text{Area of semicircle} &= \frac{1}{2} \times 3.14 \times 14^2 \\ &= 307.72\text{cm}^2\end{aligned}$$

- 16 Volume of water in tank to be filled: $250 \times 40 \times 100 \times (1 - 1/4) = 750000\text{cm}^3 =$
Every 6 minutes, overall increment in water volume:
 $(3 \times 5) - (3 \times 2) = 9$ litres

$$750 \div 9 = 83.33$$

$$83 \times 6 = 498 \text{ minutes.}$$

After 498 minutes, there would be $83 \times 9 = 747$ Litres of water filled.

$$\text{Remaining water to be filled} = 750 - 747 = 3 \text{ litres}$$

Extra time needed to filled tank completely: 1 minute

$$\text{Total time required} = 498 + 1 = 499 \text{ minutes.}$$

- 17 Trial and error test:

Assuming both ends up with similar number of candies.

$$\text{Total candies} = 35 + 50 + 45 + 10 = 140$$

$$\text{Equal amount to each person} = 140 \div 2 = 70$$

Federic - 40% choc, 60 % sweets

$$> 40/100 \times 70 = 28 \text{ choc ; } 60/100 \times 70 = 42 \text{ sweets}$$

Ryan - 70% choc, 30% sweet

$$> 70/100 \times 70 = 49 \text{ choc ; } 30/100 \times 70 = 21 \text{ sweets}$$

Resulting amount of candies:

Federic - 28 Choc, 42 sweet

Ryan - 49 Choc, 21 sweet.

Number given = 7 choc and 8 sweet.

- 18 Let L represents Large box, and S represents Small box

14 more in big carton than small carton $> L - S = 14$

Ratio of big to small is 3:1 $> 1L = 3S$

$$3S - S = 14$$

$$S = 7$$

$$L = 21$$

$$22 \text{ large and } 8 \text{ small} = 22 \times 21 + 7 \times 8 = 99 \text{ oranges}$$